

# WAVE FACTORY

MULTIFUNCTION GENERATOR

## **WF1983/WF1984**

---

Instruction Manual (Operations)





DA00101751-001

MULTIFUNCTION GENERATOR

**WF1983/WF1984**  
Instruction Manual (Operations)

---

## Preface

Thank you very much for purchasing our "Multifunction Generator WF1983/WF1984".

To use this instrument in a safe and correct manner, please first read the next section titled "Safety Precautions".

- **Caution symbols used in this manual**

The following caution symbols are used in this manual. Be sure to observe them and their accompanying information to ensure the safety of the user and avoid damage to the instrument.

---

 **WARNING**

This symbol indicates information for the avoidance of a hazard that may endanger human life or cause injury during handling of the instrument.

---

---

 **CAUTION**

This symbol indicates information for the avoidance of personal injury or instrument damage during handling of the instrument.

---

- This manual has the following chapter organization.

The instructions for remote control (GPIB, USB, and LAN) are provided in a separate file.

If using this instrument for the first time, start with "1. Overview."

1. Overview

This chapter describes the overview and brief operating principles of this product.

2. Preparations Before Use

This chapter describes important preparations before installation and operation.

3. Panels and I/O Terminals

This chapter describes the functions and operations of the switches and I/O terminals on the panels.

4. Basic Operation

This chapter describes basic operations.

5. Saving and Recalling Settings

This chapter describes how to save and recall the settings.

6. Parameter-variable Waveforms

This chapter describes the meaning of each parameter and examples of parameter-variable waveforms.

7. Creating Arbitrary Waveforms

This chapter describes how to input and edit arbitrary waveforms from the panel.

---

## 8. Convenient Use of 2-channel Equipment (WF1984 Only)

This chapter describes how to coordinate the settings of two channels.

## 9. Synchronizing Multiple Units

This chapter describes how to configure a multi-phase oscillator by connecting multiple units of this product.

## 10. Using External Frequency Reference

This chapter describes how to use an external frequency reference.

## 11. Using Sequence Oscillation

This chapter describes how to set and operate sequence oscillation.

## 12. Using User-defined Units

This chapter describes the units which users can define by themselves.

## 13. Other Utility Settings

This chapter describes how to configure detailed settings for display and operation.

## 14. Troubleshooting

This chapter describes the error messages and measures to take when problems occur.

## 15. Maintenance

This chapter describes how to perform operation inspections and performance tests.

## 16. List of Initial Settings

This chapter describes the initial settings.

## 17. Specifications

This chapter describes the product's specifications (functions and performance).

---

## Safety Precautions

To ensure safe use, be sure to observe the following warnings and cautions.

NF Corporation shall not be held liable for damages that arise from a failure to observe these warnings and cautions.

This product is a Class I instrument (with protective conductor terminals) that conforms to the JIS and IEC insulation standards.

- **Be sure to follow the instructions in the instruction manual.**

This instruction manual contains instructions for safe operation and use of this product.

Please read this manual first before using the product.

All of the warning items contained in this instruction manual are intended for preventing risks that may lead to serious accidents. Be sure to observe these warnings.

- **Be sure to ground the product.**

This product uses a line filter, which may cause electric shock if the product is not grounded.

To prevent electric shock accidents, connect the product to ground.

This product is grounded automatically by connecting a three-pin power supply plug to a power supply outlet with a protective earth contact.

- **Check the power supply voltage.**

This product operates on the power supply voltage indicated in section “2.3 Grounding and Power Supply Connection” in this instruction manual.

Prior to connecting the power supply, check that the outlet voltage matches the rated power voltage of the product.

- **If you suspect a problem**

If this product emits smoke, strange odor, or unusual sound, immediately disconnect the power cable and stop using the product.

If such an abnormality occurs, do not let anyone use this product until it has been repaired, and immediately report the problem to NF Corporation or one of our representatives.

- **Do not use this product in an explosive atmosphere.**

An explosion or other hazard may occur.

- **Do not remove the cover.**

This product contains high-voltage components. Do not remove its cover.

Inspections of the product's interior should only be performed by service technicians authorized by NF Corporation.

- **Do not modify the product.**

Do not modify the instrument under any circumstances. Modification of the instrument could cause unexpected accidents or failures. NF Corporation has the right to refuse to repair any instruments modified by unauthorized persons.

- 
- **Take care that water does not get inside the product or the product does not get wet.**

Using the product while it is wet may cause electric shock or fire. If water or other liquid has entered inside the product, immediately disconnect the power cable and contact NF Corporation or one of our representatives.

- **If a thunderstorm occurs nearby, turn off the power switch and disconnect the power cable.**

A thunderstorm may cause electric shock, fire, or failure.

- **Electromagnetic compatibility**

Applicable EMC standard: EN 61326-1

Electromagnetic environment in which intended to be used: Industrial electromagnetic environment.

When this product is connected to a measurement target, emissions exceeding the level required by the applicable EMC standard may be generated.

This product is a CISPR 11 Group 1 Class A compliant device.

If used in a residential environment, this product may cause interference. Such use must be avoided unless the user takes special measures to reduce electromagnetic emissions to prevent radio frequency interference.

To ensure compliance with EMI tolerance requirements, cables with high shielding effect such as multi-shielded cables must be used.

- **Safety-related symbols**

The general definitions of the safety-related symbols used on this product and in its instruction manual are provided below.



**Instruction Manual Reference Symbol**

This notifies the user of potential hazards and indicates the need to refer to the instruction manual.



**Electric Shock Danger Symbol**

This symbol indicates locations that present a risk of electric shock under specific conditions.



**WARNING Warning Symbol**

This symbol indicates information for the avoidance of hazards such as electric shock that may endanger human life or cause injury during handling of the instrument.

---

 **CAUTION** **Caution Symbol**

This symbol indicates information for the avoidance of damage to the instrument during handling.



**Disassembly Prohibited Symbol**

This symbol is displayed on the main unit. It indicates that disassembling this product may result in electric shock or other injury.



**Electric Shock Danger Symbol**

This symbol is displayed on the main unit. It indicates that not grounding this product may result in electric shock.



**Standby Symbol**

This symbol is displayed on the main unit. It indicates that the instrument contains components that cannot be completely cut off from the power supply source.



This mark indicates that the outer conductor of the connector is connected to the enclosure.



This mark indicates that the outer conductor of the connector is insulated from the enclosure.

However, it indicates that the potential difference from the grounding potential is restricted to 42Vpk or less for safety reasons (since this product is grounded when being used, the potential of the enclosure equals the grounding potential).

- **Requesting waste disposal**

To protect the environment, ensure that this device is disposed of by an appropriate industrial waste processor.

A battery is not used in this product. LEDs are used for the LCD backlight.



---

# Table of Contents

---

	Page
Preface .....	i
Safety Precautions .....	iii
1. Overview .....	1-1
1.1 Features .....	1-2
1.2 Operating Principles .....	1-3
2. Preparations Before Use .....	2-1
2.1 Checking Before Use .....	2-2
2.2 Installation .....	2-3
2.3 Grounding and Power Supply Connection .....	2-4
2.4 Various Downloads .....	2-4
2.5 Calibration .....	2-5
3. Panels and I/O Terminals .....	3-1
3.1 Panel Component Names and Functions .....	3-2
3.1.1 Front Panel of WF1983 .....	3-2
3.1.2 Rear Panel of WF1983 .....	3-3
3.1.3 Front Panel of WF1984 .....	3-4
3.1.4 Rear Panel of WF1984 .....	3-5
3.2 I/O Terminals .....	3-6
3.2.1 Waveform Output (FCTN OUT) .....	3-7
3.2.2 Synchronization/Sub-output (SYNC/SUB OUT) .....	3-8
3.2.3 External Modulation/Addition Input (MOD/ADD IN) .....	3-9
3.2.4 External Trigger Input (TRIG IN) .....	3-10
3.2.5 External 10 MHz Frequency Reference Input (10 MHz REF IN) .....	3-11
3.2.6 Frequency Reference Output (REF OUT) .....	3-12
3.2.7 Multi-I/O (MULTI I/O) .....	3-13
3.3 Cautions on Floating Ground Connection .....	3-15
4. Basic Operations .....	4-1
4.1 Power On/Off and Restoration of Settings .....	4-2
4.1.1 How to Turn Power On/Off .....	4-2
4.1.2 Restoration of Settings at Power-on .....	4-3
4.2 Screen Configuration and Operation .....	4-7
4.2.1 Screen Configuration .....	4-7
4.2.2 Setting screen page switching .....	4-10
4.2.3 Switching Display Format with Tabs .....	4-11
4.2.4 Top Menu .....	4-13
4.2.5 Saving a Screenshot .....	4-14
4.3 Basic Settings and Operations .....	4-15
4.3.1 To Switch between Oscillator and Sequence Oscillation .....	4-15
4.3.2 To Change Frequency, Amplitude, and Other Values .....	4-16
4.3.3 To Change the Waveform and Oscillation Mode .....	4-18
4.3.4 Shortcut Keys for Changing Basic Parameters .....	4-19
4.3.5 Functions of ENTER/CANCEL/UNDO Key .....	4-20
4.3.6 To Change the Display Unit .....	4-21
4.3.7 CH1/CH2 Switching Key and Active Channel (WF1984 Only) .....	4-23
4.3.8 Operations Available on Utility Screen .....	4-24
4.3.9 To Restore Initial Settings .....	4-26
4.3.10 To Restore Factory Default Settings .....	4-26
4.3.11 Output On/Off .....	4-27
4.3.12 To Use USB Flash Memory .....	4-30
4.4 Setting for Main Items .....	4-31
4.4.1 Text Display Screen in Continuous Oscillation Mode .....	4-31
4.4.2 To Set Oscillation Mode .....	4-31
4.4.3 To Set Waveforms .....	4-32

4.4.4	To Set Frequency .....	4-33
4.4.5	To Set Period .....	4-34
4.4.6	To Set Phase.....	4-35
4.4.7	To Set Amplitude .....	4-37
4.4.8	To Set DC Offset .....	4-38
4.4.9	To Set Output Level with High/Low Level .....	4-39
4.4.10	To Set Waveform Polarity and Amplitude Range .....	4-40
4.4.11	How to Use Auto Range/Range Hold for Output Voltage .....	4-42
4.4.12	To Set Load Impedance .....	4-44
4.4.13	To Add External Signal.....	4-45
4.4.14	To Set Duty of Square Wave.....	4-48
4.4.15	To Set the Pulse Width, Leading/Trailing Edge Times, and Transition Waveform of the Pulse Wave .....	4-50
4.4.16	To Set Ramp Wave Symmetry .....	4-55
4.4.17	To Set the Equivalent Noise Bandwidth .....	4-56
4.4.18	To Set the Setting Range Limit Values .....	4-57
4.4.19	To Select Sub Output.....	4-58
4.5	Using Parameter-Variable Waveforms.....	4-59
4.6	Using Arbitrary Waveforms.....	4-61
4.7	Setting and Operation of Modulation .....	4-63
4.7.1	Modulation Function .....	4-63
4.7.2	Modulation Types .....	4-63
4.7.3	Screen for Setting and Operation of Modulation .....	4-64
4.7.4	Common Settings and Operation of Modulation .....	4-66
4.7.5	Setting FM .....	4-70
4.7.6	Setting FSK .....	4-71
4.7.7	Setting PM .....	4-72
4.7.8	Setting PSK .....	4-73
4.7.9	Setting AM.....	4-74
4.7.10	Setting AM (DSB-SC).....	4-75
4.7.11	Setting DC Offset Modulation .....	4-77
4.7.12	Setting PWM .....	4-78
4.8	Setting and Operation of Sweep .....	4-80
4.8.1	Sweep type (Sweep type).....	4-80
4.8.2	Screen for Setting and Operation of Sweep .....	4-80
4.8.3	Common Setting and Operation of Sweep .....	4-83
4.8.4	Setting Frequency Sweep .....	4-93
4.8.5	Setting Phase Sweep.....	4-95
4.8.6	Setting Amplitude Sweep .....	4-97
4.8.7	Setting DC Offset Sweep.....	4-99
4.8.8	Setting Duty Sweep .....	4-101
4.9	Setting and Operation of Burst .....	4-103
4.9.1	Burst Oscillation Types (Burst mode).....	4-103
4.9.2	Screen for Setting and Operation of Bursts .....	4-103
4.9.3	Auto burst .....	4-106
4.9.4	Trigger burst .....	4-109
4.9.5	Gate Oscillation .....	4-114
4.9.6	Triggered Gate Oscillation.....	4-120
4.10	To Use the Synclator Function .....	4-125
4.10.1	Synclator .....	4-125
4.10.2	Operation of Synclator.....	4-125
4.10.3	Conditions Under Which Synclator Is Available .....	4-125
4.10.4	Setting procedure.....	4-127
4.11	Using Sub Waveforms .....	4-128
4.11.1	Conditions Under Which Sub Waveforms Are Available .....	4-128
4.11.2	To Set Sub Waveforms .....	4-128
4.11.3	To Set the Sub Waveform Frequency .....	4-128
4.11.4	To Set the Sub Waveform Phase .....	4-128
4.11.5	To Set the Sub Waveform Amplitude .....	4-129
4.11.6	To Set the Sub Waveform DC Offset.....	4-129

5.	Saving and Recalling Settings.....	5-1
5.1	Procedure to Save Settings.....	5-2
5.1.1	To Save to the Unit's Internal Memory.....	5-2
5.1.2	To save to USB flash memory.....	5-3
5.2	Procedure to Recall Settings.....	5-5
5.2.1	To Recall from the Unit's Internal Memory.....	5-5
5.2.2	To recall from USB flash memory.....	5-6
5.3	To Rename Setting Memory.....	5-7
5.4	To Return Saved Settings to Initial Settings.....	5-8
5.5	USB Flash Memory Operations.....	5-8
5.5.1	File List.....	5-8
5.5.2	To Change the Current Folder.....	5-9
5.5.3	To Create a Folder.....	5-9
5.5.4	To Delete a Folder.....	5-9
5.5.5	File Time Stamps.....	5-9
6.	Parameter-variable Waveforms.....	6-1
6.1	Meaning of Each Parameter and Waveform Examples.....	6-2
6.1.1	Overview.....	6-3
6.1.2	Steady Sine Group.....	6-3
6.1.3	Transient Sine Group.....	6-10
6.1.4	Pulse Group.....	6-14
6.1.5	Transient Response Group.....	6-20
6.1.6	Surge Group.....	6-24
6.1.7	Other group.....	6-26
7.	Creating Arbitrary Waveforms.....	7-1
7.1	Basics.....	7-2
7.2	Display Procedure and Overview of Screen for Creating/Editing Arbitrary Waveforms.....	7-5
7.3	Creating New Arbitrary Waveform.....	7-7
7.4	Example of Creating Simple Arbitrary Waveform.....	7-7
7.5	Outputting Created Arbitrary Waveform.....	7-9
7.6	Saving Created Arbitrary Waveform.....	7-9
7.6.1	Saving to Internal Memory.....	7-9
7.6.2	Saving to USB Flash Memory.....	7-10
7.7	To Retrieve the Saved Arbitrary Waveform.....	7-12
7.7.1	To Retrieve from Internal Memory.....	7-12
7.7.2	To Retrieve from USB Flash Memory.....	7-13
7.8	File Operations.....	7-14
7.8.1	To Delete Saved Arbitrary Waveform.....	7-14
7.8.2	To Rename.....	7-15
7.8.3	To Create a Folder in USB Flash Memory.....	7-17
7.9	Identifying Memory Space Required for Saving Arbitrary Waveforms.....	7-18
8.	Convenient Use of 2-channel Equipment.....	8-1
8.1	Outline.....	8-2
8.2	Copying Settings between Channels.....	8-3
8.3	Unifying Settings of 2 Channels.....	8-5
8.4	Synchronizing Phase between Channels.....	8-6
8.5	Keeping Frequencies for Both Channels Set to Same Value (2-Channel Coordination: 2Phase).....	8-7
8.6	Keeping Frequency Difference Constant (2-Channel Coordination: 2Tone).....	8-9
8.7	Keeping Frequency Ratio Constant (2-Channel Coordination: Ratio).....	8-11
8.8	Obtaining Differential Output (2-Channel Coordination: Differential).....	8-13
8.9	Obtaining Double Output Voltage (2-Channel Coordination: Diff2).....	8-14
9.	Synchronizing Multiple Units.....	9-1
9.1	Connection Procedure.....	9-2
9.2	Performing Synchronization.....	9-4
10.	Using External Frequency Reference.....	10-1
10.1	Purpose of Using External Frequency Reference.....	10-2
10.2	Connection and Usage Procedure of External Frequency Reference.....	10-2
11.	Using Sequence Oscillation.....	11-1
11.1	Sequence Oscillation.....	11-2

11.2	Sequence Oscillation Example .....	11-2
11.3	Basics .....	11-4
11.4	In-Step Processing Flow .....	11-12
11.5	Setting and Operation Procedure .....	11-13
11.6	Saving Created Sequence .....	11-18
11.6.1	Saving to Internal Memory .....	11-18
11.6.2	Saves to USB Flash Memory .....	11-19
11.7	Using the Saved Sequence .....	11-20
11.7.1	To Retrieve from Internal Memory .....	11-20
11.7.2	To Retrieve from USB Flash Memory .....	11-21
11.8	File Operations .....	11-22
11.8.1	To Delete Saved Sequence Data .....	11-22
11.8.2	To Rename .....	11-23
11.8.3	To Create a Folder in USB Flash Memory .....	11-24
11.9	Outline of Screen .....	11-25
11.10	Individual Descriptions of Step Control Parameters .....	11-26
12.	Using User-defined Units .....	12-1
12.1	About User-defined Units .....	12-2
12.2	Display and Setting in User-defined Units .....	12-2
12.3	Defining User-defined Units .....	12-2
13.	Other Utility Settings .....	13-1
13.1	Selecting Remote Interface [Remote] .....	13-2
13.2	Display and Operation Sound Settings [System] .....	13-3
13.3	Self-Diagnosis [Self Check] .....	13-3
13.4	Product Information Display [Information] .....	13-4
14.	Troubleshooting .....	14-1
14.1	Error Messages at Power-on .....	14-2
14.2	Error Messages while Running .....	14-3
14.3	Conflict Messages for Modulation .....	14-8
14.4	Conflict Messages for Sweep .....	14-9
14.5	Conflict Message for Burst .....	14-10
14.6	Sequence Compiler Message .....	14-11
14.7	When Suspect a Failure .....	14-12
15.	Maintenance .....	15-1
15.1	Introduction .....	15-2
15.2	Routine Maintenance .....	15-2
15.3	Storage When Not Used for a Long Period of Time .....	15-3
15.4	Repacking and transportation .....	15-3
15.5	Operation Inspections .....	15-5
15.6	Performance Tests .....	15-6
15.6.1	Frequency Accuracy Test .....	15-6
15.6.2	Sine Wave Amplitude Accuracy Test .....	15-7
15.6.3	DC Offset Accuracy Test .....	15-7
15.6.4	Sine Wave Amplitude/Frequency Characteristics Test .....	15-8
15.6.5	Sine Wave Total Harmonic Distortion Test .....	15-9
15.6.6	Sine Wave Harmonic Spurious Test .....	15-10
15.6.7	Sine Wave Non-harmonic Spurious Test .....	15-10
15.6.8	Square Wave Duty Accuracy Test .....	15-11
15.6.9	Square Wave Leading/Trailing Time Test .....	15-11
15.6.10	Time Difference Between Channels for 2-Phase (WF1984 Only) .....	15-12
16.	List of Initial Settings .....	16-1
16.1	Settings Related to Oscillator .....	16-2
16.2	Settings Related to Sequence Oscillation .....	16-3
16.3	Other Factory Default Settings .....	16-4
17.	Specifications .....	17-1
17.1	Oscillation Mode .....	17-2
17.2	Waveform .....	17-2
17.2.1	Standard Waveform .....	17-2
17.2.2	Arbitrary Waveform .....	17-2

17.3	Frequency and Phase .....	17-3
17.4	Output Characteristics .....	17-3
17.4.1	Amplitude .....	17-3
17.4.2	DC Offset .....	17-4
17.4.3	Load Impedance Setting .....	17-4
17.4.4	Waveform Output .....	17-4
17.4.5	Synchronization/Sub-output (SYNC/SUB OUT) .....	17-4
17.5	Main Signal Characteristics .....	17-5
17.5.1	Sine wave .....	17-5
17.5.2	Square wave .....	17-5
17.5.3	Pulse Wave .....	17-6
17.5.4	Ramp Wave .....	17-6
17.5.5	Parameter-variable Waveform .....	17-7
17.6	Modulation Function .....	17-10
17.6.1	General .....	17-10
17.6.2	Modulation Conditions .....	17-10
17.7	Sweep oscillation mode .....	17-11
17.7.1	General .....	17-11
17.7.2	Sweep Conditions .....	17-12
17.8	Burst oscillation mode .....	17-13
17.9	Synclator Function .....	17-14
17.10	Triggers .....	17-14
17.11	Sequences .....	17-15
17.12	Other I/Os .....	17-15
17.12.1	BNC Connector Placement .....	17-16
17.13	2 Channel Coordination Operation (WF1984 Only) .....	17-17
17.14	Synchronization of Multiple Units .....	17-18
17.15	User-defined Units .....	17-18
17.16	Setting Value Upper and Lower Limit Function .....	17-18
17.17	Other Functions .....	17-19
17.18	External Storage .....	17-19
17.19	Remote Interfaces .....	17-19
17.20	Options .....	17-19
17.21	General Characteristics .....	17-19

---



---

## Figures and Tables

---

	Page
Figure 1-1 WF1983 Block Diagram .....	1-4
Figure 1-2 WF1984 Block Diagram .....	1-5
Figure 3-1 Front Panel of WF1983 .....	3-2
Figure 3-2 Rear Panel of WF1983 .....	3-3
Figure 3-3 Front Panel of WF1984 .....	3-4
Figure 3-4 Rear Panel of WF1984 .....	3-5
Figure 3-5 Multi-I/O connector pin configuration diagram .....	3-14
Figure 3-6 Cautions on floating ground connection for WF1983 .....	3-16
Figure 3-7 Cautions on floating ground connection for WF1984 .....	3-16
Table 3-1 Signals Selectable for Synchronization/Sub-output .....	3-8
Table 3-2 Multi-I/O connector pin assign .....	3-14
Table 11-1 Sequence setting details .....	11-2



# 1. Overview

1.1	Features .....	1-2
1.2	Operating Principles .....	1-3

---

## 1.1 Features

The WAVE FACTOR “WF1983 Multifunction Generator” and “WF1984 Multifunction Generator” are digital multifunctional oscillators.

The WF1983 features one-channel output and the WF1984 features two-channel output.

- Maximum frequency: 60MHz (sine wave), 30MHz (square wave, pulse)
- Frequency accuracy:  $\pm(1 \text{ ppm}+4 \text{ pHz})$ , minimum resolution 0.01  $\mu\text{Hz}$ . Supports a 10 MHz external frequency reference.
- Maximum output voltage: 21 V<sub>p-p</sub>/open, 10.5 V<sub>p-p</sub>/50  $\Omega$
- Many standard waveforms with flexibly variable parameters: Sine wave, square wave (variable duty), pulse (variable pulse width/duty, leading edge time, and trailing edge time), ramp wave (variable symmetry), CF control sine wave (variable crest factor), staircase sine wave (variable number of steps), Gaussian pulse (variable  $\sigma$ ), Sin(x)/x (variable number of zero crossings), exponential rise/fall (variable time constant), damped oscillation (variable oscillation frequency and damping time constant), pulse surge (variable rising and duration time), trapezoid wave (variable rise, fall, and upper base width), etc.
- Synclator function to output an external input signal at the same or a submultiple frequency
- Output waveform resolution: approximately 16 bit (retains high resolution across a wide range of output voltages)
- High-capacity arbitrary waveform memory: Maximum 64Mi words, storage capacity of approx. 4Gi words
- Continuous phase and uninterrupted waveform during frequency change and frequency sweep
- Various oscillation modes
  - Continuous oscillation
  - Modulation: FM, FSK, PM, PSK, AM, DC offset modulation, PWM
  - Sweep: Frequency, phase, amplitude, DC offset, and duty
  - Burst oscillation: Auto burst, trigger burst, gate oscillation, triggered gate oscillation
  - Sequence oscillation: Waveform/frequency/phase/amplitude/DC offset and square wave duty, constant value /linear interpolation, jump/repeat/hold/branch
- Sequence function included for easy test waveform creation and editing  
Allows flexible waveform generation by combining standard waveforms and arbitrary waveforms  
Supports rapid change and sweep of frequency, phase, amplitude, etc.
- Channel coordination with 2 phases, constant frequency difference, constant frequency ratio, etc. (only WF1984)
- WF1983 and WF1984 have the ground floating from the enclosure for each channel to reduce the effect of ground loop.
- Supports the synchronization of multiple units to configure a multiphase oscillator.
- Storage of settings, arbitrary waveforms, and other data in USB flash memory
- Supports output of frequencies and waveforms from sub output different from those of the main output.
- Includes USB, GPIB, and LAN interfaces
- Slim and lightweight with approximate height of 9 cm and weight of 1.8 kg



---

## 1.2 Operating Principles

A block diagram of WF-1983 is shown in Figure 1-1, and block diagram of WF1984 is shown in Figure 1-2.

### ■ Analog Section

- The digital synthesizer (DDS) operates on a 240 MHz clock and generates various types of oscillations and waveforms. It generates a sample cycle signal when the wave form is an arbitrary waveform.

Modulation, sweeps, and bursts are also processed inside the DDS FPGA.

- The digital waveforms generated by the DDS are controlled to the specified polarity (normal or inversed) and amplitude range ( $-FS/0$ ,  $\pm FS$ ,  $0/+FS$ ), and then input into the D/A converter.
- Amplitude control is performed by the D/A, and the waveforms converted into analog signals are then smoothed by the lowpass filter (LPF).
- The amplitude is controlled in 10 dB steps by the PG AMP (variable gain amp).
- An external addition signal and DC offset are added to the PG AMP output. If an output voltage of  $\pm 0.4$  V/open or less is sufficient, output is via a  $\times 1/5$  attenuator. If an output voltage greater than  $\pm 2$  V/open is required, output is via a  $\times 5$  amplifier.
- The maximum output voltage of this product is 21 Vp-p, 4 Vp-p, or 0.8 Vp-p depending on whether or not the 1/5x attenuator or the 5x amplifier is used. Correspondingly, the external addition gain changes to  $\times 10$ ,  $\times 2$ , or  $\times 0.4$ .
- The 0 dB range or -14 dB range is selected for the DC offset in order to achieve the optimal resolution.
- The external modulation signal is passed through the LPF, and then converted from analog to digital and input into the DDS.
- The analog section is insulated from the system controller section which is connected to the enclosure potential.
- In the WF1984, there are analog sections for two channels that are each independent and insulated from the enclosure potential.

### ■ System Controller

- This section controls the analog section, including the display, panel key processing, remote control (GPIB, USB, and LAN) processing, trigger input processing, frequency reference control, DDS control, amplitude, and DC offset.
- A 20 MHz crystal oscillator is used as the basic oscillation of the DDS.
- The signal to synchronize multiple units is sent to REF OUT (frequency reference output), and also an inter-channel synchronization signal is sent to the analog section of each channel.

### ■ Power Supply

- The AC/DC source directly connected to the power input is in a constantly powered state.
- The startup, shutdown, and other control of the power supply circuit of each section in the WF1983/WF1984 is performed by power switch operation.

■ WF1983 Block Diagram

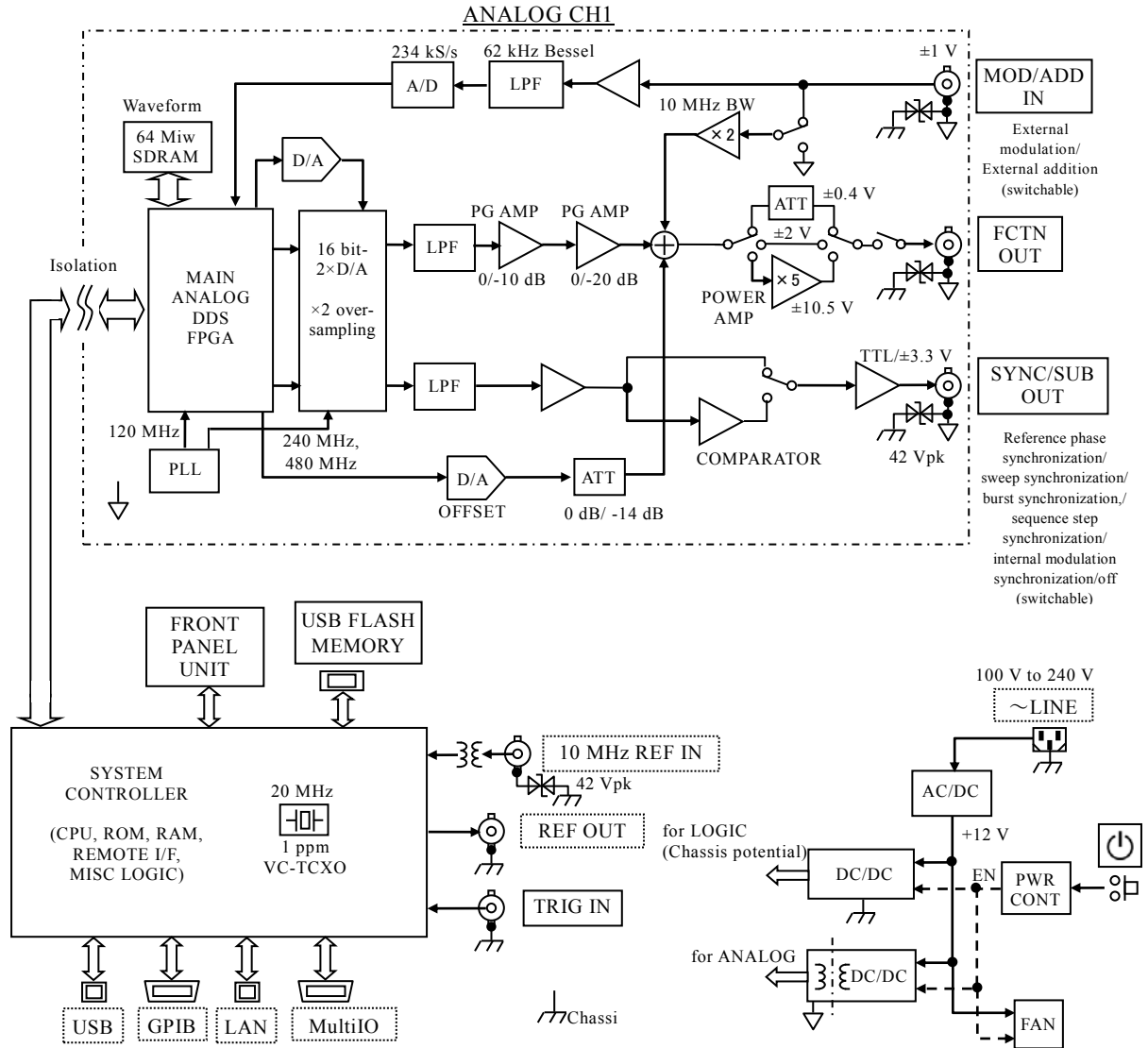

Figure 1-1 WF1983 Block Diagram

■ WF1984 Block Diagram

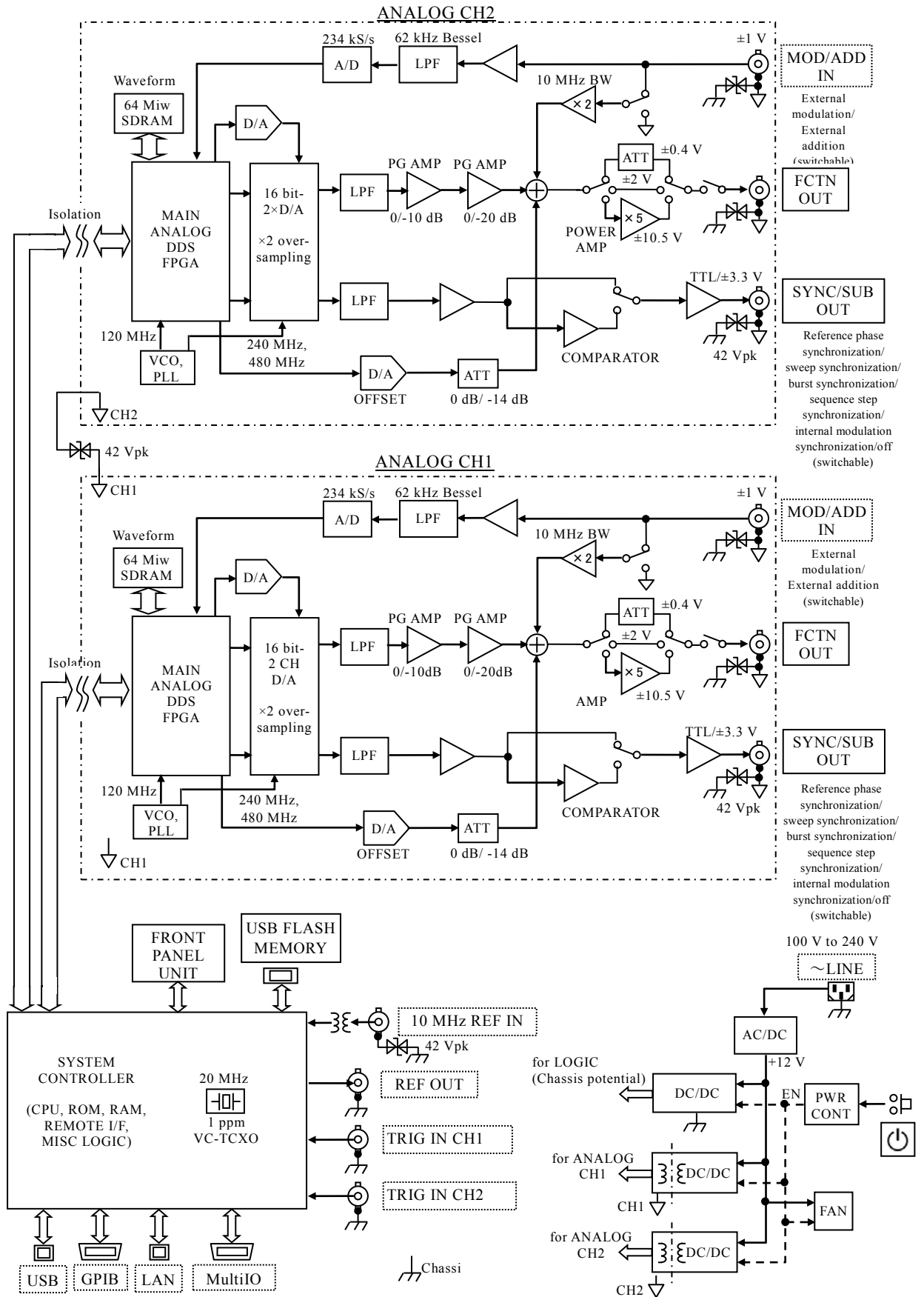

Figure 1-2 WF1984 Block Diagram

---

MEMO



## 2. Preparations Before Use

2.1	Checking Before Use.....	2-2
2.2	Installation.....	2-3
2.3	Grounding and Power Supply Connection .....	2-4
2.4	Various Downloads.....	2-4
2.5	Calibration.....	2-5

---

## 2.1 Checking Before Use

### a) Safety check

For your own safety, please be sure to first read the following sections of this manual.

- "Safety Precautions" (See page iii.)
- "2.3 Grounding and Power Supply Connection"

### b) Checking the Exterior and Accessories

If the exterior of the cardboard container appears to be damaged (scrapes, dents, etc.), carefully check the product for any signs of damage after taking it out of the container.

Check all of the items that were taken out of the container.

If there are any signs of damage to the exterior of the product, missing accessories, or other problems, contact NF Corporation or one of our representatives.

- **Checking the Exterior**

Check that the panels, knobs, connectors, and other parts are not damaged or dented.

- **Checking the Configuration and Accessories**

This product is configured as follows: Please confirm that no items are missing or damaged.

Main unit .....	1
Accessories	
Power cable set (2 m with 3-pin plug) .....	1
Safety Information.....	1
Simple instruction manual .....	1

---

## WARNING

This product contains high-voltage components. Do not remove its cover. Inspections of the product's interior should only be performed by service technicians authorized by NF Corporation.

---

### c) Options

The following options are available. Please purchase them separately.

- Multi-I/O Cable (PA-001-1318)

This cable is used when using the multi-I/O connector on the rear panel.

A 2 m multi-core shielded cable is connected to the mini-Dsub 15-pin connector. The opposite end is cut off, so process it according to the connection target.

For details on connector pin assignment and cable differentiation, <sup>REF</sup> P. 3-14

- Rack Mounting Kit

This kit contains adapters for mounting the instrument in a 19-inch IEC and EIA standard rack or JIS standard rack.

There are four types of adapter in total, an adapter for one unit and an adapter for two units (for side-by-side mounting) for each product model.

---

## 2.2 Installation

### a) Installation location

Do not place the instrument with the rear panel facing downward. The connectors may be damaged and ventilation will be blocked. Place the instrument on a flat surface such as on a desk so that the four rubber feet and stands on the bottom rest on that surface.

### b) Installation conditions

- **This product uses forced-air cooling by fan, and has air intake and exhaust vents on the sides and rear panel. Install the instrument with its sides and rear panel at least 10 cm away from walls and other obstructions to so that the air circulation will not be blocked.**
- **Install the instrument in a location where the temperature and humidity meet the following conditions.**

Operation: 0 to 40°C, 5 to 85%RH

Storage: -10 to 50°C, 5 to 95%RH

Use the instrument in a condensation-free state. For limitations related to absolute humidity, refer to the specifications in this manual.

- **Install the instrument at an altitude of 2.000 m or less.**
- **Do not install the instrument in the following locations:**
  - Location where inflammable gas is present  
There is a risk of an explosion. Never install and use the instrument in such an environment.
  - Outdoors, location exposed to direct sunlight, or located near fire or a heat source  
The instrument may not meet the performance specifications or may fail.
  - Place with corrosive gas, moisture, dirt, or dust, place with high humidity, or place with high salinity  
The instrument may corrode or fail.
  - Place near an electromagnetic field source, high-voltage equipment, or power line  
The instrument may malfunction.  
Powerful electromagnetic radio frequencies may mix with the output.
  - Location with excessive vibration  
The instrument may malfunction or fail.

### c) Rack mounting method

This product can be mounted in a 19-inch IEC and EIA standard rack or JIS standard rack using a rack mounting kit (optional). There is a kit for one unit and a kit for two units. First, attach the rack mounting kit to the main unit, and then mount the unit in the rack. For how to use the rack mounting kit, refer to the manual included with the kit. Pay attention to the following points when mounting the instrument in a rack.

- Be sure to install rails in the rack to support the instrument.
- Do not mount this product in a fully enclosed rack as the internal temperature may rise high enough to cause a failure.

---

Provide sufficient ventilation holes in the rack, or provide forced-air cooling by fan.

For the dimensional drawings for rack mounting, refer to:

Rack mount (EIA, for 1 unit PA-001-3838)	☞ P.17-23
Rack mount (EIA, for 2 units PA-001-3839)	☞ P.17-24
Rack mount (JIS, for 1 unit PA-001-3840)	☞ P.17-25
Rack mount (JIS, for 2 units PA-001-3841)	☞ P.17-26

## 2.3 Grounding and Power Supply Connection

Be sure to ground the product.

### **WARNING**

This product uses a line filter, which may cause electric shock if the product is not grounded.

To prevent electric shock accidents, connect the product to ground.

This product is grounded automatically by connecting a three-pin power supply plug to a power supply outlet with a protective ground contact.

#### a) Power supply conditions

Rated voltage: 100 VAC to 240 VAC

Rated frequency: 50 Hz / 60 Hz

Power consumption: WF1983: 50 VA or lower, WF1984: 75 VA or lower

#### b) Connection procedure of the power source

- 1) Confirm that the voltage of the commercial power source to be connected is within the allowable voltage range of this product.
- 2) Connect the power cord to the power supply inlet on the rear panel of this product.
- 3) Connect the power cord to a three-pin power supply outlet.

### **CAUTION**

The accessory power supply cable set is designed to be used with this product only. Do not use it for any other product or purpose.

**The power code set can be used for disconnecting the product from AC power line in case of emergency.**

### **WARNING**

Maintain enough space around the inlet to enable the connector of the power cord to be removed from the inlet or use a power outlet located at a convenient place with adequate space around it so that the plug can be removed from the outlet.

- The power cable set can be used to separate the product from the commercial power supply in case of emergency.

## 2.4 Various Downloads

Search for the latest firmware and instruction manuals for this product as well as the application software for editing arbitrary waveforms and sequences from the support page of



---

our website (<http://www.nfcorp.co.jp/>).

For how to check the firmware version of the product, see section 13.4.  P. 13-4

## 2.5 Calibration

Although dependent on the operating environment and frequency of use, this product should undergo performance testing at least once a year. In addition, we recommend performing a performance test immediately before carrying out important measurements and tests.

Performance testing should be performed by a person with experience operating and general knowledge about measuring instruments.

For details on performance testing,  P.15-6.

---

MEMO



## **3. Panels and I/O Terminals**

3.1	Panel Component Names and Functions.....	3-2
3.2	I/O Terminals.....	3-6
3.3	Cautions on Floating Ground Connection .....	3-15

### 3.1 Panel Component Names and Functions

This section describes the names and functions of the components on the front panel and rear panel.

#### 3.1.1 Front Panel of WF1983

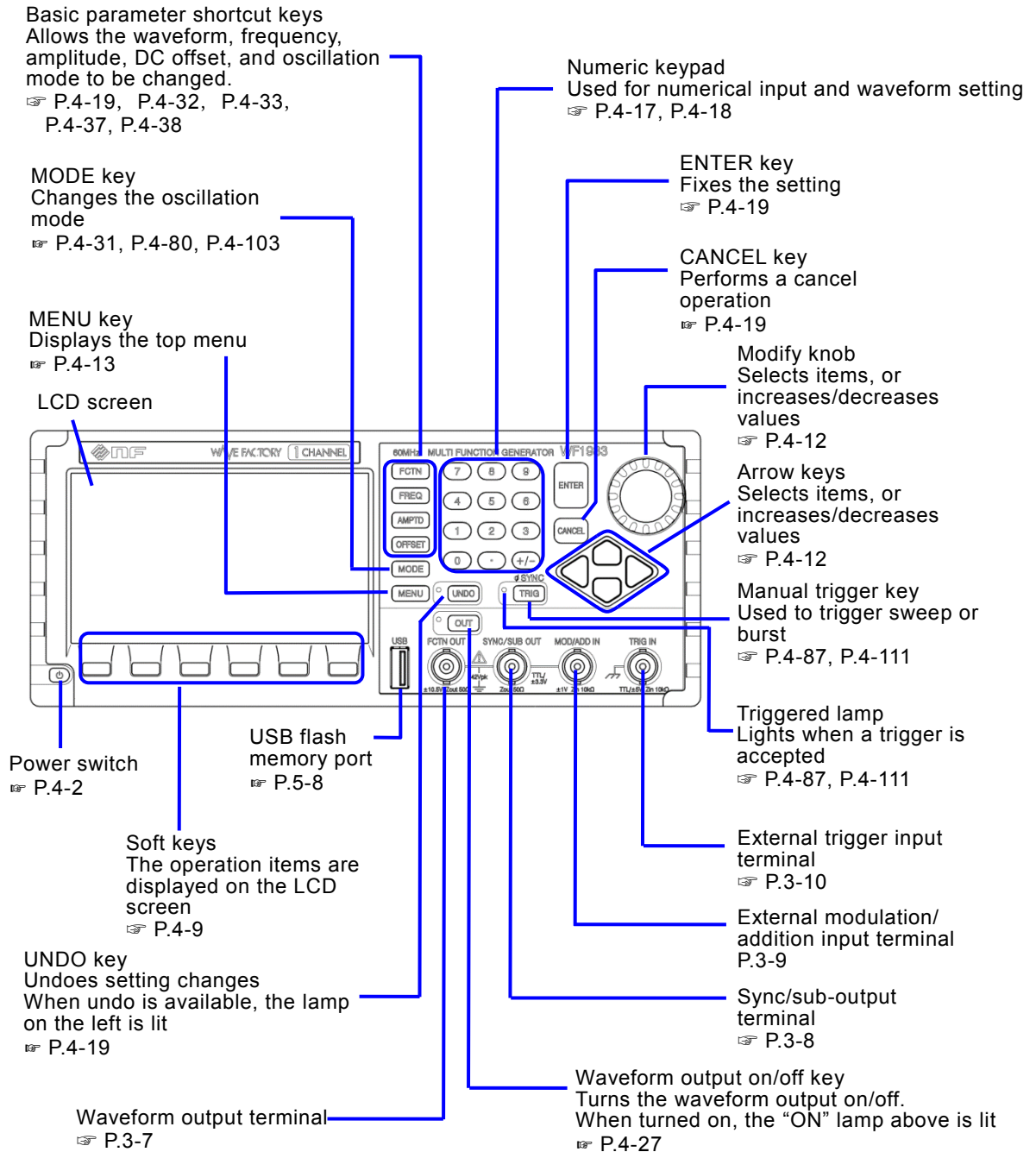

Figure 3-1 Front Panel of WF1983

3.1.2 Rear Panel of WF1983

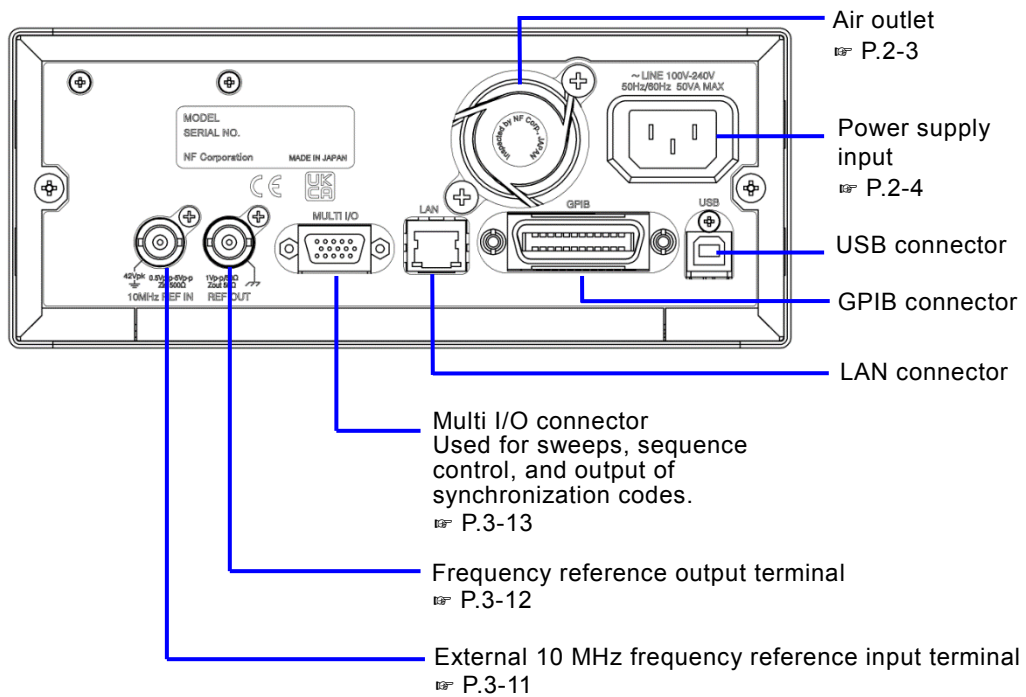

Figure 3-2 Rear Panel of WF1983

3.1.3 Front Panel of WF1984

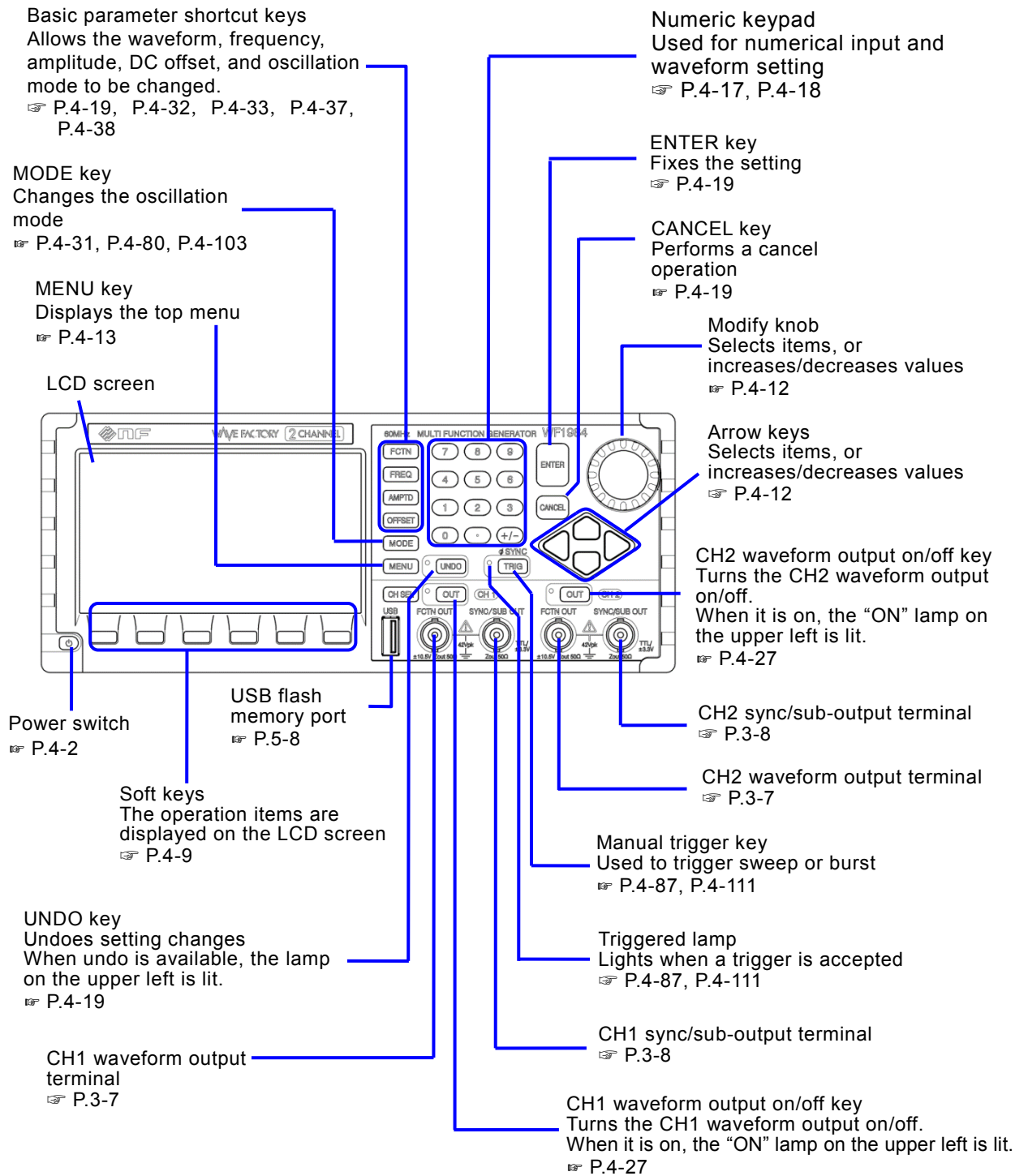

Figure 3-3 Front Panel of WF1984

3.1.4 Rear Panel of WF1984

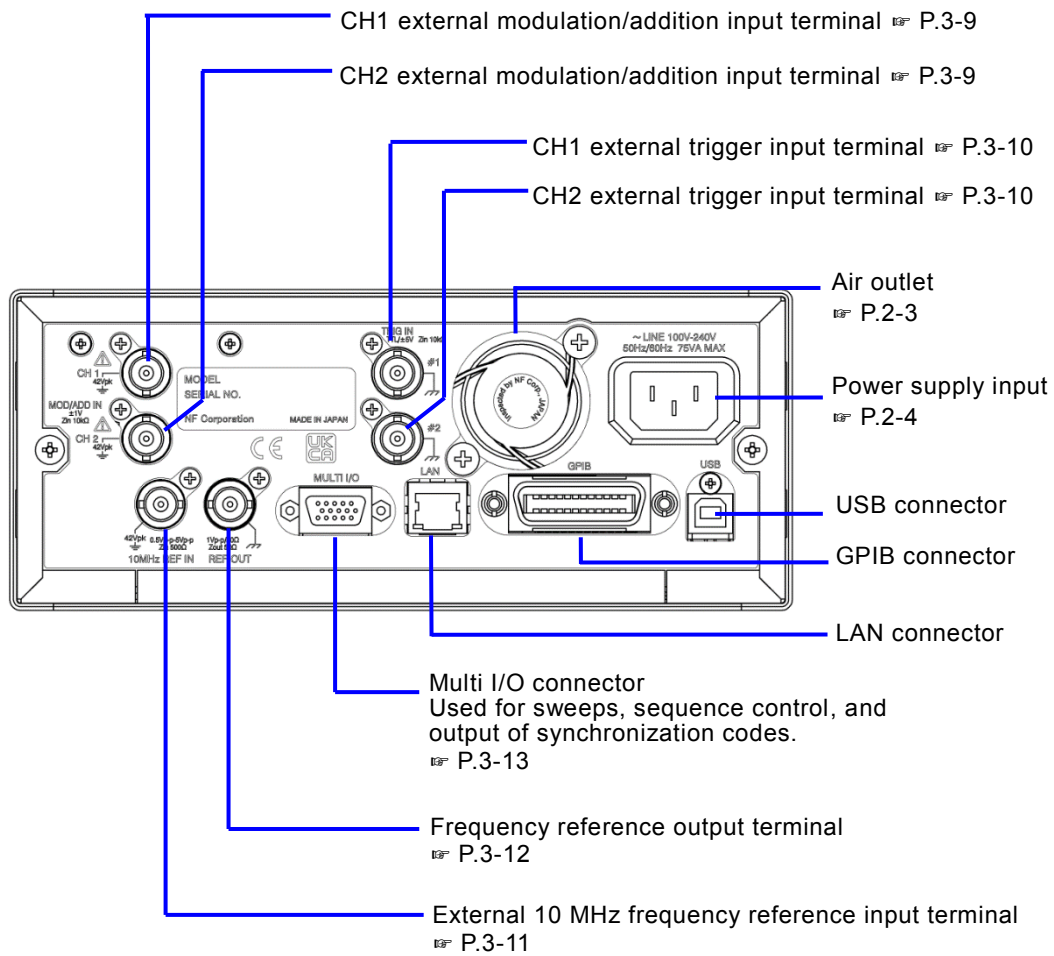

Figure 3-4 Rear Panel of WF1984

---

## 3.2 I/O Terminals

---

### WARNING

To prevent electric shocks, do not apply a voltage exceeding 42 Vpk (DC + AC peak) between the ground of the BNC connectors insulated from the enclosure and the enclosure.

Also, do not apply a voltage exceeding 42 Vpk (DC + AC peak) between the grounds of the BNC connector groups insulated from the enclosure. "BNC connector groups" used here indicates multiple BNC connectors that are connected to a common ground.

If such a high voltage is applied, the internal voltage limiting elements will try to reduce the voltage, but a voltage that is too high may cause the product to burnout.

☞ P.3-15

---

---

### CAUTION

Do not apply a voltage from external to the output terminals.  
This may damage the product.

---

---

### CAUTION

Do not apply a voltage exceeding the maximum allowable voltage to the input terminal. This may damage the product.

---

---

### CAUTION

If a difference in potential exists between the ground of a BNC connector insulated from the enclosure and the enclosure, do not short-circuit the hot side of that BNC connector and the enclosure. This may damage the product.

---

---

### CAUTION

If a difference in potential exists between the grounds of BNC connectors, do not short circuit these BNC connector grounds. This may damage the product.

---



3.2.1 Waveform Output (FCTN OUT)

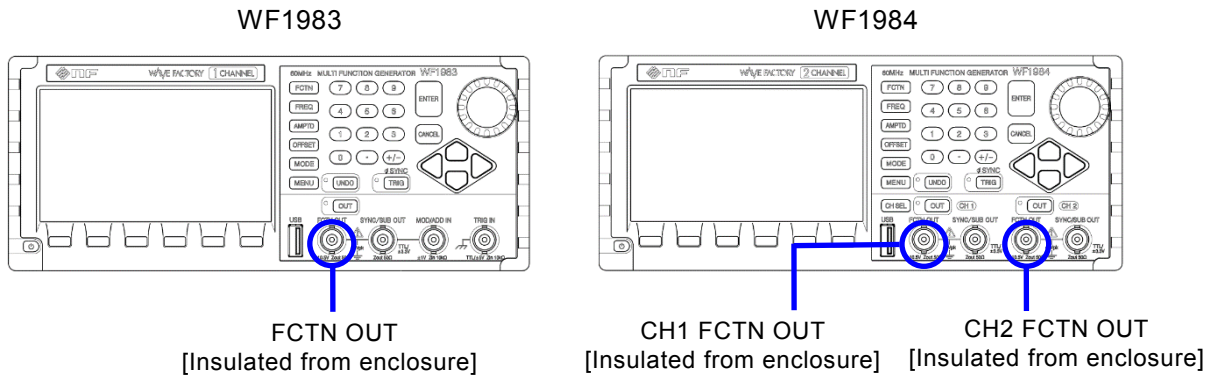

A signal with the set waveform, frequency, and amplitude is output.

■ Output characteristics

Output voltage	Maximum $\pm 10.5$ V/open
Output impedance	50 $\Omega$
Load impedance	0 $\Omega$ or higher (can be short-circuited)
Signal GND	Insulated from the enclosure (maximum 42 Vpk). In WF1984, also insulated between channels (maximum 42 Vpk)

☞ Check

A mechanical relay is used for the on/off setting of FCTN OUT waveform output. This causes chattering to occur when the waveform output is switched on or off. Please use the trigger burst or gate oscillation mode when connecting to equipment which might malfunction due to chattering. ☞ P.4-109, P.4-114

☞ Check

The relay inside the instrument for switching output on/off is a part with a limited life. Switching output on/off frequently may lead to a failure early and even within the warranty period of the product. The life expectancy of the relay is about 100,000 times. Also consider using the trigger burst and gate oscillation modes instead of on/off. ☞ P.4-109, P.4-114

3.2.2 Synchronization/Sub-output (SYNC/SUB OUT)

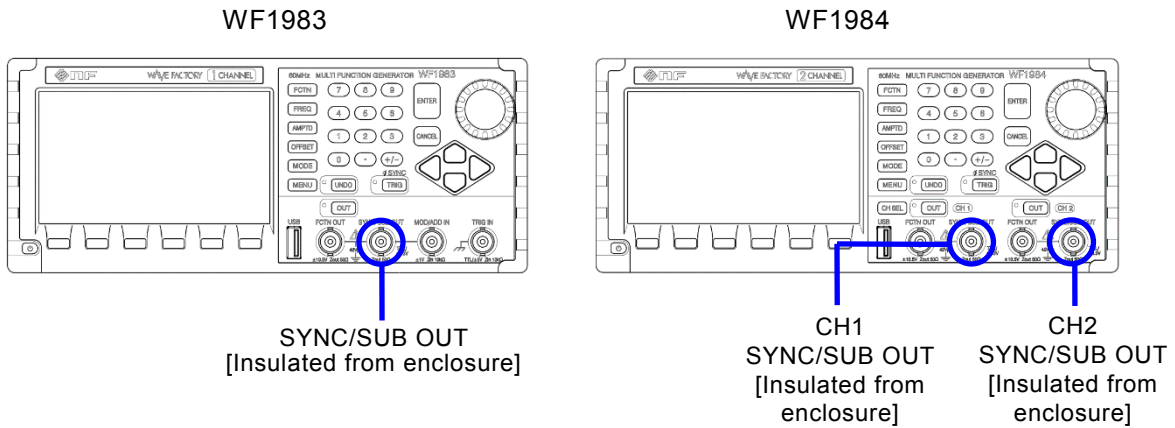

A synchronization signal is output according to the waveform or oscillation status. This signal can be used as the synchronization signal for oscilloscope.

An internal modulation signal or sub waveform can also be output. If a synchronization signal is not required, you can use it as an additional channel.

As shown in the following table, the output signal can be selected according to the oscillation mode.

Table 3-1 Signals Selectable for Synchronization/Sub-output

Oscillation Mode	Selectable output signal
Modulation function is off or modulation source is external	<ul style="list-style-type: none"> <li>Reference phase synchronization signal (see the table below)</li> <li>Secondary waveform (maximum -3.3 V to +3.3 V/open) <small>☞</small> P. 4-128</li> </ul>
Modulation function is on and modulation source is internal <small>☞</small> P.4-68	<ul style="list-style-type: none"> <li>Reference phase synchronization signal</li> <li>TTL level signal synchronized with internal modulation signal</li> <li>Internal modulation signal (maximum -3.3 V to +3.3 V/open)</li> </ul>
Sweep oscillation mode <small>☞</small> P.4-89	<ul style="list-style-type: none"> <li>Reference phase synchronization signal</li> <li>TTL level signal synchronized with sweep, marker signal mixing possible</li> </ul>
Burst oscillation mode <small>☞</small> P.4-107, P.4-112, P.4-116, P.4-123	<ul style="list-style-type: none"> <li>Reference phase synchronization signal</li> <li>TTL level signal synchronized with burst oscillation</li> </ul>

■ About reference phase

The reference phase is an internal signal that becomes the base for generating the waveforms that are output to the waveform output.

There are independent reference phases also for the sub waveform and internal modulation signal. With the WF1984, the reference phase of each channel is independent.

Each of the reference phases can be first zeroed by the phase synchronization operation. ☞ P.8-6

■ About reference phase synchronization signal

The reference phase synchronization output is a 50% duty TTL level logic signal that rises at zero degree of the reference phase. If the phase setting is changed, the phase between the reference phase

synchronization signal and waveform output can be changed. [P.4-35](#)

At high frequencies, there is a phase difference equivalent to about 10 ns even with a 0° setting due to the difference in the propagation delay time of the output circuits of the waveform output and synchronization/sub output. This phase difference can be adjusted by setting the phase.

#### ■ Output characteristics

Output voltage	TTL level (low: 0.4 V or lower, high: 2.7 V or higher), Maximum -3.3 V to +3.3 V/open (variable), 0 V to +3 V open
Output impedance	50 Ω
Load impedance	50 Ω or higher is recommended
Signal GND	Same potential as the same channel waveform output, and insulated from the enclosure (maximum 42 Vpk). In WF1984, also insulated between channels (maximum 42 Vpk)

### 3.2.3 External Modulation/Addition Input (MOD/ADD IN)

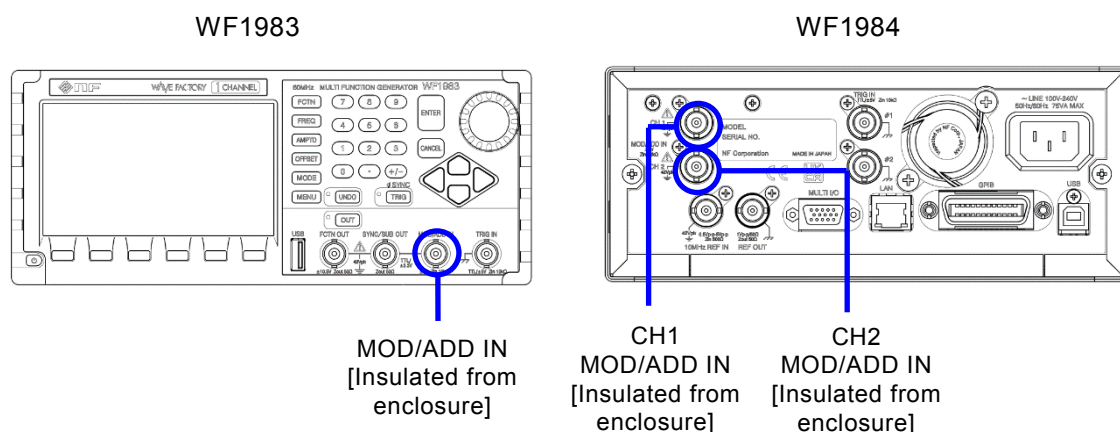

When the modulation source is external, except for FSK and PSK, an external modulation signal is input. For FSK and PSK, the external trigger input is used as the external modulation signal input. When not used as external modulation signal input, this terminal can be used as the external addition signal input to the waveform output. The gain during external addition is  $\times 0.4$ ,  $\times 2$ , or  $\times 10$ .

External modulation input [P.4-67](#)

External addition input [P.4-45](#)

#### ■ Input characteristics

Input voltage	$\pm 1$ V full scale
Maximum allowable input	$\pm 2$ V
Input impedance	10 kΩ
Input frequency	During modulation: DC to 50 kHz (-3dB) During addition: DC to 10 MHz (-3dB)
Signal GND	Same potential as the same channel waveform output, insulated from the enclosure (maximum 42 Vpk). In WF1984, also insulated between channels (maximum 42 Vpk)

3.2.4 External Trigger Input (TRIG IN)

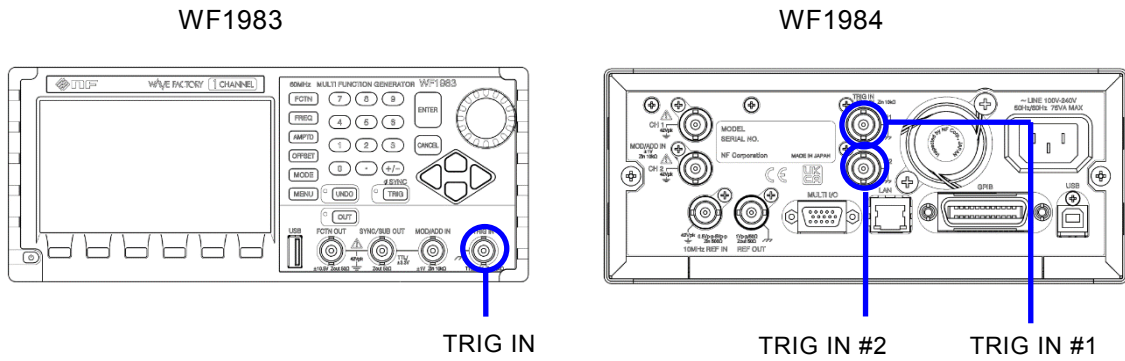

This terminal can be used as external trigger input in the following cases. The polarity setting can be changed.

- Start trigger of single sweep [P.4-87](#)
- Start trigger of gated single sweep [P.4-87](#)
- Start trigger of trigger burst oscillation [P.4-111](#)
- Gate of gate oscillation [P.4-115](#)
- Trigger of triggered gate oscillation [P.4-122](#)
- Start trigger of sequence oscillation [P.11-10](#)

It can also be used as the external modulation input for FSK and PSK. [P.4-67](#)

■ Input characteristics

Input voltage	TTL level (low: 0.8 V or lower, high: 2.6 V or higher)
Maximum allowable input	-0.5 V to +5.5 V
Input impedance	10 kΩ, pull up to +3 V
Signal GND	Same potential as the enclosure

## 3.2.5 External 10 MHz Frequency Reference Input (10 MHz REF IN)

WF1983

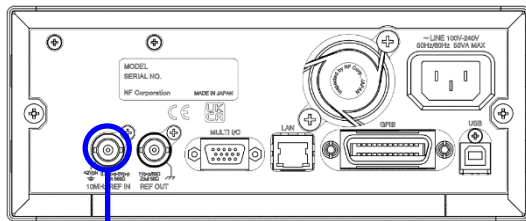
10MHz REF IN  
[Insulated from enclosure]

WF1984

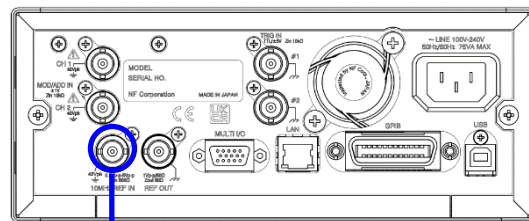
10MHz REF IN  
[Insulated from enclosure]

This terminal can be used for the following purposes.

- When frequency accuracy higher than the frequency accuracy specification of this product is required, or when you want to use the same frequency reference as a different signal generator

Input the 10 MHz reference signal from an external frequency standard.

Switch the external frequency reference setting to [Enable]. [P.10-4](#)

- To unify the frequency and phase of multiple WF1983/WF1984 units

Connect the frequency reference output of the master unit when multiple units are connected together with a synchronous connection, or the master WF1983 or WF1984, to the external 10 MHz frequency reference input of the slave WF1983 or WF1984.

Also, switch the external frequency reference setting of the slave units to [Enable], and perform the [ØSYNC] reference phase initialization operation on the master unit. [P.9-4](#)

The connected WF1983/WF1984 units all have the same frequency accuracy as the master unit.

A signal from an external frequency standard can be used for the master unit.

- Input Characteristics

Input voltage	0.5 Vp-p to 5 Vp-p
Maximum allowable input	10 Vp-p
Input impedance	300 Ω, unbalanced, AC coupled
Input frequency	10 MHz ( $\pm 0.5\%$ ( $\pm 50$ kHz))
Input waveform	Sine or square wave (50 $\pm$ 5% duty)
Signal GND	Insulated from enclosure and each channel waveform output (maximum 42 Vpk).

#### Check

- When not using frequency reference input, do not input a signal to this terminal. The instrument may malfunction.
- Do not connect REF OUT and REF IN of the same enclosure. The instrument will malfunction.

## 3.2.6 Frequency Reference Output (REF OUT)

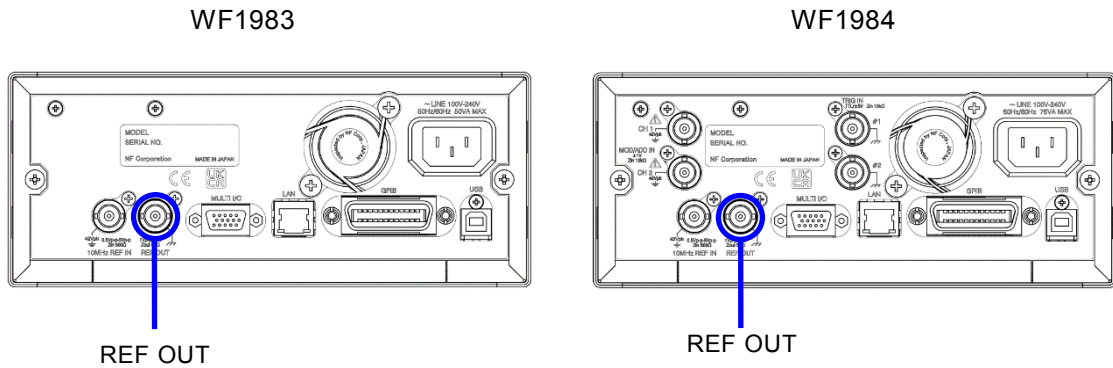

This terminal is used to unify the frequency and phase of multiple WF1983/WF1984 units. Connect the frequency reference output of the master unit when multiple units are connected together with a synchronous connection, or the master WF1983 or WF1984, to the external 10 MHz frequency reference input of the slave WF1983 or WF1984.

☞ P.9-2

#### ■ Output Characteristics

Output voltage	1 V <sub>p-p</sub> / 50 Ω
Output impedance	50 Ω, AC coupled
Output frequency	10 MHz
Output waveform	Square wave
Signal GND	Same potential as the enclosure

#### ☞ Check

Do not connect any equipment other than WF1983, WF1984, and the equipment specified by NF Corporation to the frequency reference output.

The special signal that is output from this terminal during synchronization may make the operation of such connected equipment unstable.

3.2.7 Multi-I/O (MULTI I/O)

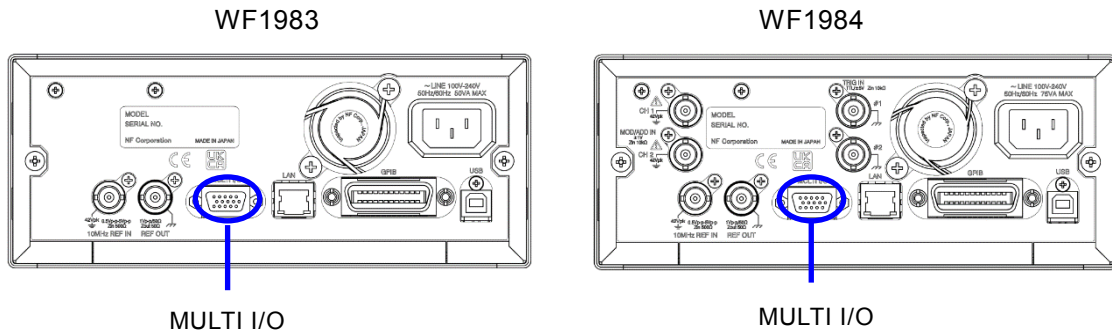

This terminal can be used for sweep and sequence control. It outputs the step synchronization code for the sequence.

■ Control Input for sweep oscillation mode

Sweep oscillation can be controlled as follows using 3-bit logic input. [P.4-91](#)

Start	Starts the sweep from beginning by fall input. ORed with external trigger input.
Stop	Stops the sweep by fall input.
Hold/Resume	Holds the sweep by fall input during sweep execution. Resumes the sweep from the hold point by fall input during a hold.

■ Control Input for sequence oscillation

Sequence oscillation can be controlled as follows using 4-bit logic input. [P.11-10](#)

Start or State branch	You may choose start control or state branch control. During start control, the sequence is started from the beginning by fall input. ORed with external trigger input. During state branch control, the sequence is branched to the designated destination step by low level input at the end of the step.
Stop	Stops the sequence by fall input.
Hold/Resume	Holds the sequence by fall input during sequence execution. Resumes the sequence from the hold point by rise input during a hold.
Event Branch	Branches the sequence to the designated destination step by fall input.

■ Step code output for sequence oscillation

The 4-bit step synchronization code specified for each step is output.

✔ Check

When control input of the multi I/O will not be used, we recommend disabling control input to prevent a malfunction due to external noise. [P.4-91](#)

### 3.2 I/O Terminals

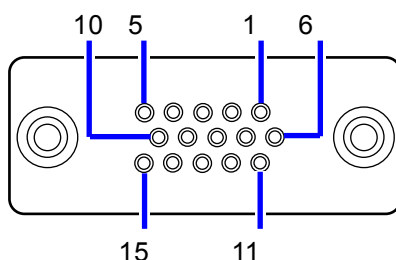

Figure 3-5 Multi-I/O connector pin configuration diagram

Table 3-2 Multi-I/O connector pin assign

Pin No.	I/O	Sweep oscillation mode	Sequence oscillation	General-purpose I/O (Note 2) (Remote command only)	Insulation color / marking
1	Output	Not in use	Step synchronization code D0 (LSB)	General-purpose output 0	Light brown and <span style="border: 1px solid black; padding: 0 2px;">Black</span>
2	Output	Not in use	Step synchronization code D1	General-purpose output 1	Light brown and <span style="border: 1px solid black; padding: 0 2px;">Red</span>
3	Output	Not in use	Step synchronization code D2	General-purpose output 2	Yellow and <span style="border: 1px solid black; padding: 0 2px;">Black</span>
4	Output	Not in use	Step synchronization code D3 (MSB)	General-purpose output 3	Yellow and <span style="border: 1px solid black; padding: 0 2px;">Red</span>
5	Output	Do not connect anything.	Do not connect anything.	Do not connect anything.	Bright green and <span style="border: 1px solid black; padding: 0 2px;">Black</span>
6	GND	—	—	—	Bright green and <span style="border: 1px solid black; padding: 0 2px;">Red</span>
7	GND	—	—	—	Gray and <span style="border: 1px solid black; padding: 0 2px;">Black</span>
8	GND	—	—	—	Gray and <span style="border: 1px solid black; padding: 0 2px;">Red</span>
9 (Note 1)	Reserved	Do not connect anything.	Do not connect anything.	Do not connect anything.	White and <span style="border: 1px solid black; padding: 0 2px;">Black</span>
10	GND	—	—	—	White and <span style="border: 1px solid black; padding: 0 2px;">Red</span>
11	Input	Not in use	Event branch	General-purpose input 0	Light-brown and <span style="border: 1px solid black; padding: 0 2px;">Black</span> <span style="border: 1px solid black; padding: 0 2px;">Black</span>
12	Input	Hold/resume	Hold/resume	General-purpose input 1	Light-brown and <span style="border: 1px solid black; padding: 0 2px;">Red</span> <span style="border: 1px solid black; padding: 0 2px;">Red</span>
13	Input	Stop	Stop	General-purpose input 2	Yellow and <span style="border: 1px solid black; padding: 0 2px;">Black</span> <span style="border: 1px solid black; padding: 0 2px;">Black</span>
14	Input	Start	Start or state branch	General-purpose input 3	Yellow and <span style="border: 1px solid black; padding: 0 2px;">Red</span> <span style="border: 1px solid black; padding: 0 2px;">Red</span>
15	Input	Not in use	Not in use	Not in use	Bright green and <span style="border: 1px solid black; padding: 0 2px;">Black</span> <span style="border: 1px solid black; padding: 0 2px;">Black</span>
Shell	—	—	—	—	Bright green and <span style="border: 1px solid black; padding: 0 2px;">Red</span> <span style="border: 1px solid black; padding: 0 2px;">Red</span>

Note 1: +5 V is output to pin no. 9, but do not connect the pin to anything because it is for production. The product may become unstable if this pin is used.

Note 2: This can be used as the input and output of each 4 bits that can be read and written by external control. For details, refer to "Controlling Multi-I/O Connector" in Instruction Manual (Remote Control).

#### ■ I/O Characteristics

Input voltage	TTL level (low: 0.8 V or lower, high: 2.6 V or higher)
Maximum allowable input	-0.5 V to +5.5 V
Input impedance	10 kΩ, pull up to +5 V
Output voltage	TTL level (low: 0.4 V or lower, high: 2.7 V or higher)
Signal GND	Same potential as the enclosure
Connector	Mini D-sub 15-pin

The connection cable is an option. Please contact NF Corporation or one of our representatives for



details.

### 3.3 Cautions on Floating Ground Connection

The signal ground of the BNC terminals for waveform output, synchronization/sub-output, and modulation/addition input is shared, but since it is insulated from the enclosure (ground potential), it can be connected to equipment that has a different potential. Moreover, when the equipment is mounted in a rack, the signal ground is not affected by the potential of the rack.

In WF1984, the above-mentioned BNC terminals are also insulated between channels.

Furthermore, the signal ground of the 10 MHz frequency reference input is also insulated from the enclosure. Therefore, noise caused by ground-loop does not affect the connection with a frequency standard.

Nor does noise caused by ground-loop affect the connection even when synchronously connecting multiple units of WF1983 and WF1984.

Note that, in all cases, the floating voltage should be limited to 42 Vpk (DC + AC peak) or lower to prevent electric shocks.

The other signal grounds are all connected to the enclosure. The enclosure itself is connected to a protective conductor terminal of the power supply input.

---

#### **WARNING**

To prevent electric shocks, do not apply a voltage exceeding 42 Vpk (DC + AC peak) between the ground of the BNC connectors insulated from the enclosure and the enclosure.

Also, do not apply a voltage exceeding 42 Vpk (DC + AC peak) between the grounds of the BNC connector groups insulated from the enclosure. "BNC connector groups" used here indicates multiple BNC connectors that are connected to a common ground.

If such a high voltage is applied, the internal voltage limiting elements will try to reduce the voltage, but a voltage that is too high may cause the product to burnout.

---

---

#### **CAUTION**

If a difference in potential exists between the ground of a BNC connector insulated from the enclosure and the enclosure, do not short-circuit the hot side of that BNC connector and the enclosure. This may damage the product.

---

---

#### **CAUTION**

If a difference in potential exists between the grounds of BNC connectors, do not short circuit these BNC connector grounds. This may damage the product.

---

### 3.3 Cautions on Floating Ground Connection

■ Cautions on floating ground connection for WF1983

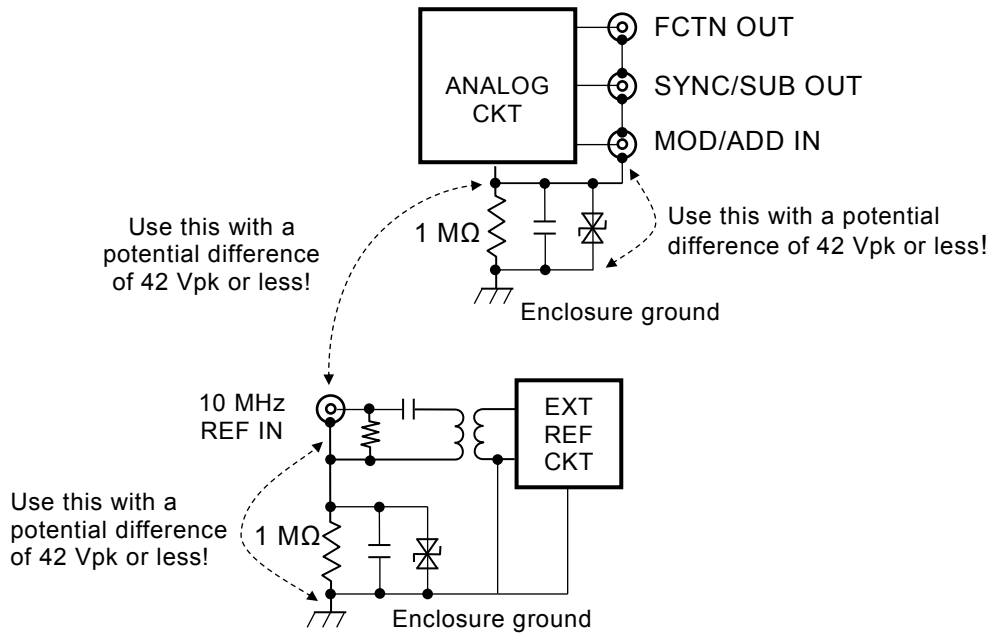

Figure 3-6 Cautions on floating ground connection for WF1983

■ Cautions on floating ground connection for WF1984

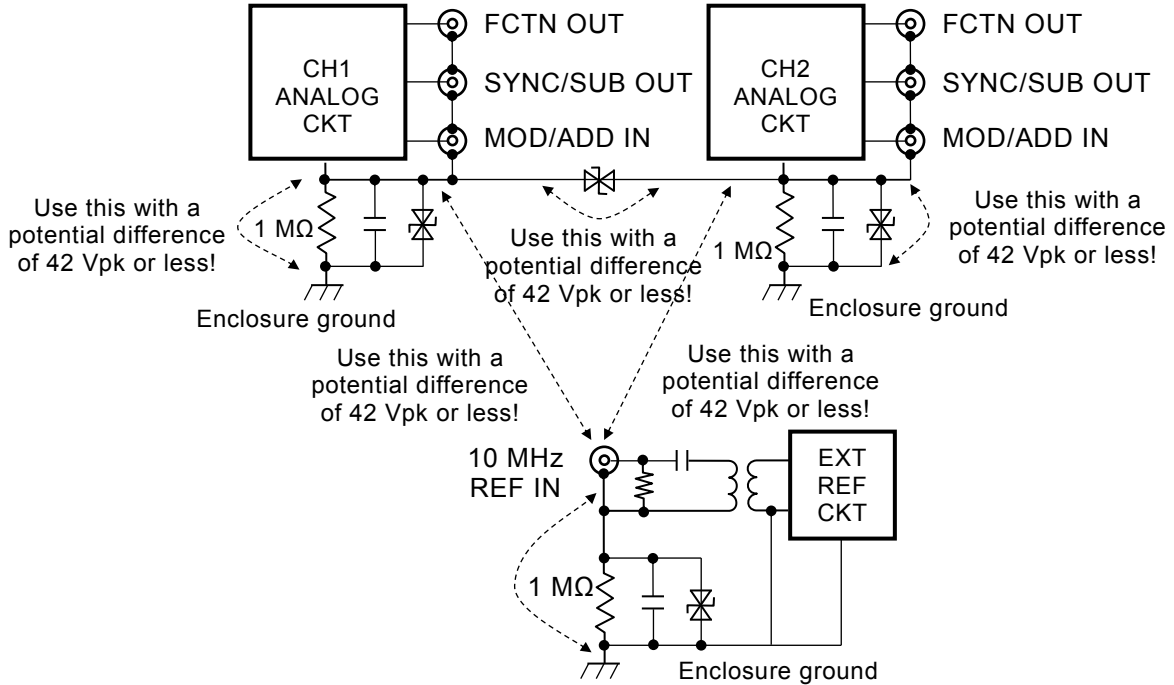

Figure 3-7 Cautions on floating ground connection for WF1984

---

## 4. Basic Operations

4.1	Power On/Off and Restoration of Settings .....	4-2
4.2	Screen Configuration and Operation .....	4-7
4.3	Basic Settings and Operations .....	4-15
4.4	Setting for Main Items.....	4-31
4.5	Using Parameter-Variable Waveforms .....	4-59
4.6	Using Arbitrary Waveforms .....	4-61
4.7	Setting and Operation of Modulation .....	4-63
4.8	Setting and Operation of Sweep.....	4-80
4.9	Setting and Operation of Burst .....	4-103
4.10	To Use the Synclator Function.....	4-125
4.11	Using Sub Waveforms .....	4-128

## 4.1 Power On/Off and Restoration of Settings

### 4.1.1 How to Turn Power On/Off

#### ■ Power-on operation



Power off state  
(standby state)

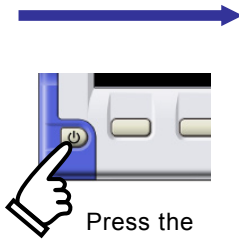

Press the  
power switch

The start screen is displayed

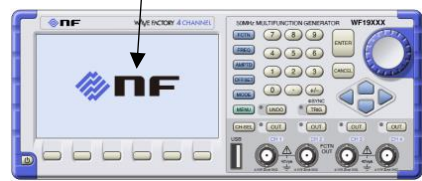

The power is turned on

Once the power is turned on, a self test is executed automatically, and then the instrument becomes operable.

#### ■ Power-off operation



Power on state

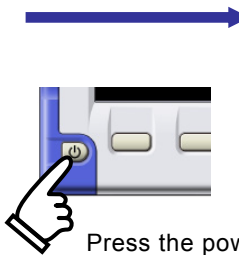

Press the power  
switch

The display goes off

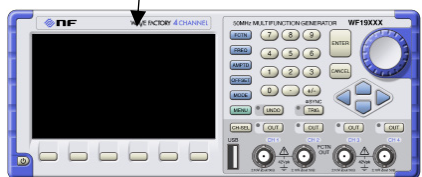

The power is turned off  
(standby state)

4.1.2 Restoration of Settings at Power-on

When the power is turned on by the power switch, the settings when the power switch was last turned off are restored. However, the output on/off settings at power-on can be set on the Utility screen. [P.4-28](#)

If the power supply to the product is directly cut off without operation of the power switch, the settings are set to the contents of setting memory number 1 when the power supply is restored.

a) Restoration of settings when the power switch is turned on/off while power is supplied

The most general case is illustrated below.

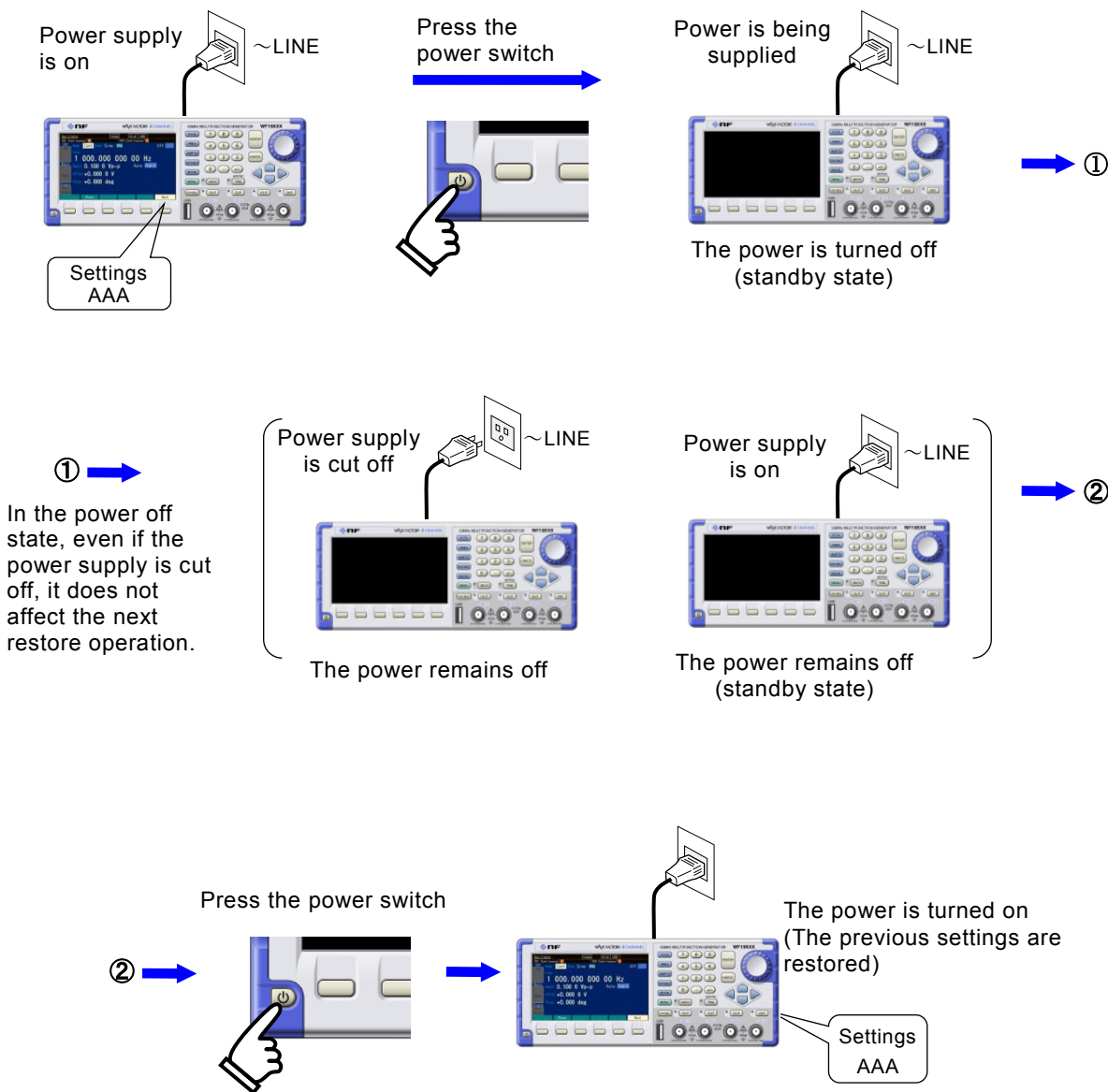

## 4.1 Power On/Off and Restoration of Settings

---

While the power is off, even if the power supply is cut off by, for example, shutting off the breaker or even if the power cable is disconnected, this will not affect the restore operation when the power is turned on again next time.

- The settings before the last power-off are restored.
- The output on/off settings at power-on can be changed on the Utility screen.  P.4-24
- The sequence oscillation and sequence state (restarts from beginning when Run/Hold) are also restored.

### Check

The settings immediately before the power-off can only be restored if the power is turned off using the power switch.

b) Restoration of settings at power supply on/off

This is the case when you collectively turn on/off the power supply for this product and other devices which are mounted in a rack.

When the power supply is cut off while the power is on, the power is automatically turned on the next time the power supply is resumed.

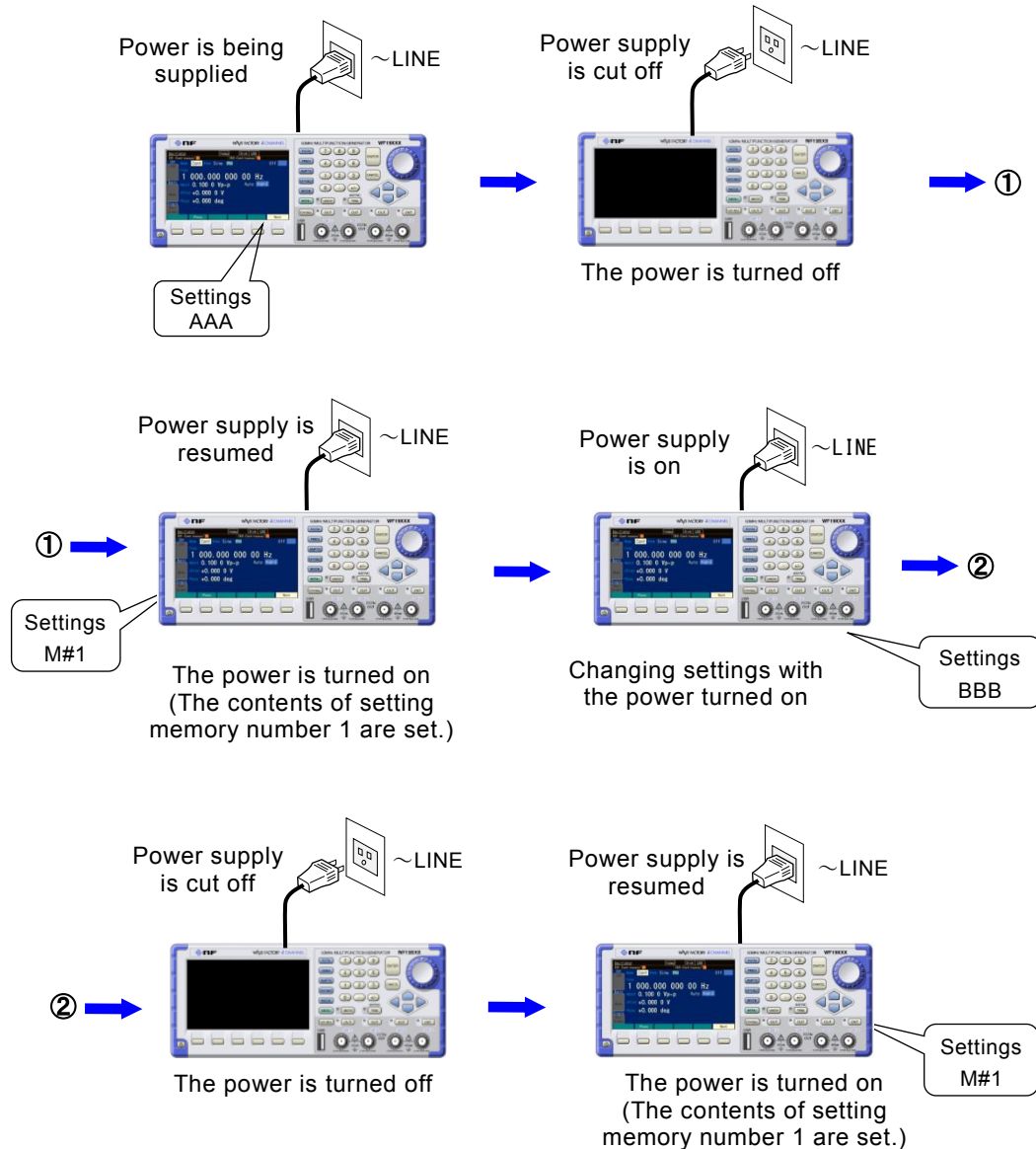

- The settings immediately before are not restored.
- The contents of setting memory number 1 are set. [P.5-2](#)
- The output on/off settings at power-on can be changed on the Utility screen. [P.4-24](#)
- Whether to start in sequence mode can be changed on the Utility screen. [P.4-24](#)
- When the unit starts in sequence mode, the sequence stored in sequence memory 1 will be executed automatically.

### ✓ Check

Since the settings before the power supply is cut off are not restored, specify the contents of setting memory number 1 in advance if needed. ↗ P.5-2

A sequence must already be saved in order for it to be restored.



## 4.2 Screen Configuration and Operation

### 4.2.1 Screen Configuration

The LCD screen consists of four areas, as shown in the following figure.



#### ■ Tab area

These tabs are for switching the setting parameters to display in the setting area.

The tabs are split into three groups, and the settings that are displayed vary depending on the combination of the three tabs.

The three groups indicate the active channel specification, setting screen page specification, and display format specification, respectively.

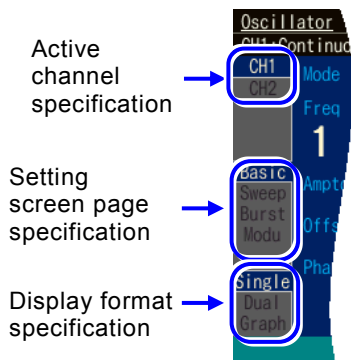

- Active channel specification (WF1984 only)

This indicates the channel to be displayed in the setting area. To switch the channel, move the cursor to the desired tab and press the ENTER key. Alternatively, press the CH-SEL key.

☞ P.4-23

- Setting screen page specification

This allows you to switch the page to be displayed in the setting area. ☞ P.4-10

- Display format switching

This allows you to switch the format for the setting parameters displayed in the setting area.

☞ P.4-11

■ Status display area

Displays the status of the product. The following items are displayed.

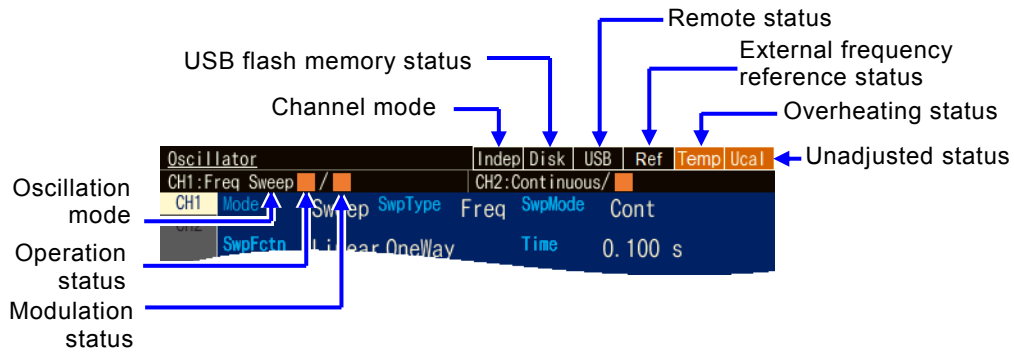

- Channel mode (WF1984 only)  
Displays the current channel mode.  
INDEP (independent) / 2PHASE (2-phase) / 2TONE (constant frequency difference) /  
RATIO (constant frequency ratio) / DIFF (differential output) / DIFF2 (voltage doubler  
output)  
For details on the channel mode setting, see P.8-2.
- USB flash memory status  
Displayed when a valid USB flash memory is inserted.
- Remote status USB, GPIB, LAN  
Displayed when the product is controlled via USB, GPIB or LAN.
- External frequency reference status Ref  
Displays whether a valid signal is input or not when the external frequency reference is  
enabled.
- Overheating status Temp  
Displayed when the internal temperature of the product is abnormally high. If this status is  
displayed when the product is used at an ambient temperature of 40°C or less, it indicates a  
failure, so please contact NF Corporation or one of our representatives.
- Unadjusted status UCal  
Displayed when the correction values of the product are lost for some reason, and the  
prescribed performance cannot be maintained. As this indicates a failure, please contact NF  
Corporation or one of our representatives.
- Oscillation mode  
Displays the current oscillation mode.  
Continuous (continuous oscillation) / Freq Sweep (frequency sweep) / Phase Sweep (phase  
sweep) / Amptd Sweep (amplitude sweep) / Offset Sweep (DC offset sweep) / AutoBurst  
(auto burst) / Trigger (trigger burst) / Gate (gate oscillation) / TrigGate (trigger gate  
oscillation)  
For details on the oscillation mode setting see P.4-31
- Operation status  
Displays the oscillation status when in sweep oscillation mode and burst oscillation mode.  
■ indicates that stopped, ► that executing, || that paused, and that waiting for trigger.

- Modulation state

Displays the oscillation status when in sweep oscillation mode and burst oscillation mode.

■ indicates that stopped, ▶ that executing, ■■ that paused.

- Setting area

This area is used to display and set the parameters.

The settings displayed in the setting area vary depending on which of the tabs in the tab area are selected.

In the following example, the basic parameters of CH1 are displayed in single format.

For details on switching the tabs, see P.4-10.

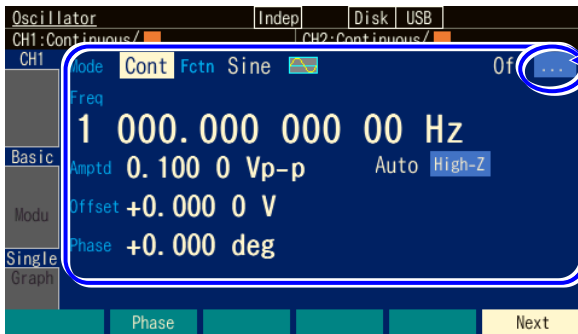

When "... " is displayed, it indicates that there are setting items below.

The settings displayed in the setting area vary depending on the selected tabs.

- Soft key display area

This area displays the functions of the soft keys which are allocated according to the situation.

If more than six soft keys are allocated, "▼ n/m" is displayed on the right-most soft key. This indicates that the set of soft keys belonging to the current setting screen consists of m stages in total, and that the set for the nth stage is currently displayed. When you press this right-most key, the soft key set for the next stage is displayed.

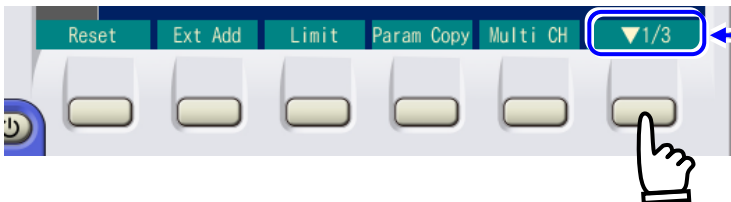

Indicates that the first of three stages of soft keys are displayed.

The soft keys for the next stage are displayed with each press.

### 4.2.2 Setting screen page switching

The setting screen has a total of four pages, and the names [Basic], [Sweep], [Burst], and [Modu] are displayed respectively for them in the tab area.

Page 1 [Basic] and page 4 [Modu] are always displayed, and page 2 [Sweep] is displayed additionally when in sweep oscillation mode and page 3 [Burst] is displayed additionally when in burst oscillation mode.

To switch pages, press the Next soft key. Alternatively, move the cursor to the tab to which to switch, and press the ENTER key.



In the example on the left, there are page 1 [Basic] and page 4 [Modu], and an indication shows that page 1 is being displayed.

There are page 1 and page 4, and page 1 is displayed in the setting area.

The page of the setting screen can be switched with the NEXT soft key.

#### a) Setting screen types

##### ■ Page 1: [Basic]

This page is for displaying the frequency, amplitude, DC offset, and other basic parameters. The number of displayed items may increase depending on the waveform.

The page is indicated by the name [Basic] in the tab area. This page can always be selected.

##### ■ Page 2: [Sweep]

This page is for displaying the sweep start value, sweep time, and other parameters specific to the sweep oscillation mode.

The page is indicated by the name [Sweep] in the tab area. This page is displayed only when in the sweep oscillation mode.

##### ■ Page 3: [Burst]

This page is for displaying the mark wave number, trigger source selection, and other parameters specific to the burst oscillation mode.

The page is indicated by the name [Burst] in the tab area. This page is displayed only when in the burst oscillation mode.

##### ■ Page 4: [Modu]

This page is for displaying the modulation type, modulation source, and other parameters for modulation. The displayed items vary depending on the waveform and modulation type.

The page is indicated by the name [Modu] in the tab area. This page can always be selected.

### 4.2.3 Switching Display Format with Tabs

When multiple display formats can be selected, the display format switching tabs are displayed on the left side of the screen. For example, if the [Graph] tab screen is displayed, you can set the parameters while checking the image of the output waveform.

#### a) Display format types

The following three types of display formats are provided on the Oscillator screen.

- Text display [Single]

Displays the settings for one channel in text format

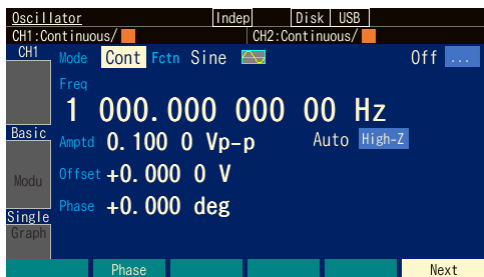

- Graph display [Graph]

Displays the settings for one channel in both text and graph formats. This allows you to check an image of the output waveform.



- 2-channel simultaneous display [Dual] (WF1984 only)

Displays the settings of CH1 and CH2 in text format arranged vertically one above the other.

The channel to be set can be switched by using the CH-SEL key.

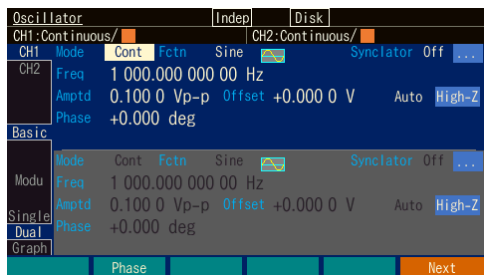

**b) To switch the display format**

The Single tab screen is displayed

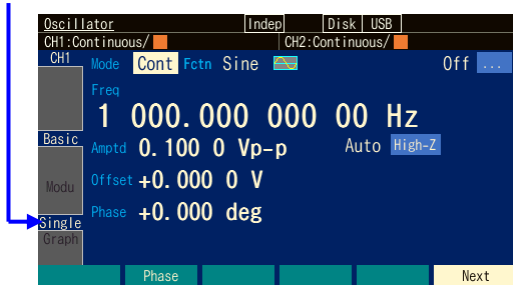

1. In the example on the left, the Single tab screen is displayed. On this screen, the settings are displayed in text format.

The Graph tab is selected

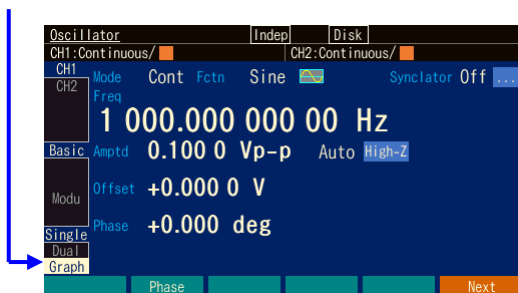

2. Use the arrow keys or the modify knob to select the Graph tab.

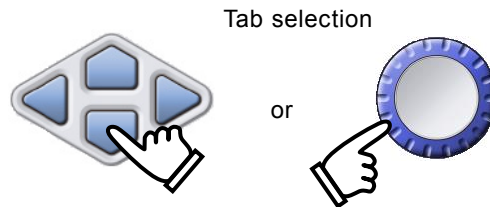

The Graph tab screen is displayed

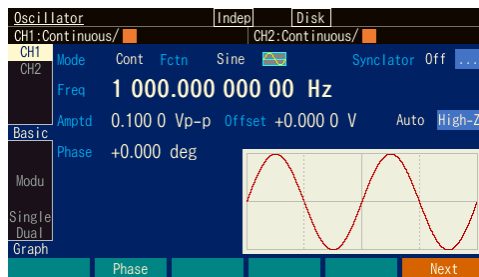

3. Press the ENTER key to switch to the Graph tab screen. On this screen, you can set the parameters while checking the image of the output waveform.



**✓ Check**

In WF1984, the display can be switched between 2-channel simultaneous display and 1-channel display with the tabs.

### 4.2.4 Top Menu

Oscillator/sequence switching, arbitrary waveform editing, system settings, saving and recalling settings, and other tasks can be performed by selecting the desired item from the top menu.

#### a) To display the top menu

Pressing the MENU key displays the following top menu window.

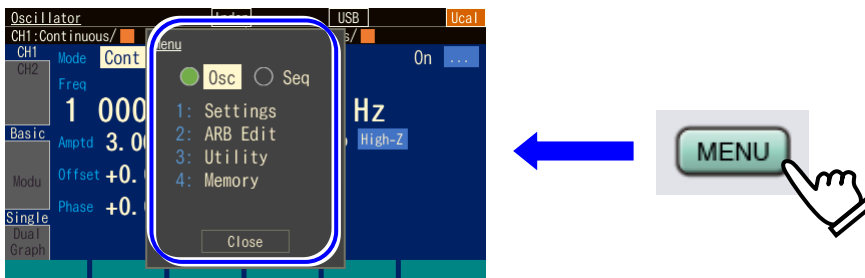

The menu items are displayed

Select the desired item with the arrow keys or the modify knob and then press ENTER key. With the top menu window open, specify the menu item using the numeric keypad [1] to [4].

#### b) Operations available using top menu items

In the setting screens displayed with each menu item, you can configure the following settings and perform the following operations.

- **Osc/Seq selector buttons**  
Switches between oscillator and sequence oscillation. [P.4-15](#)
- **Setting**  
Sets parameters.
- **ARB Edit**  
Edits an arbitrary waveform. [P.7-5](#)
- **Utility**  
Sets and operates various items. [P.4-24](#)
- **Memory**  
Saves and recalls in the setting memory, arbitrary waveform memory, and sequence memory.  
Saving and recalling settings [P. 5-2](#) and [P.5-6](#)  
Saving and recalling arbitrary data [P. 7-9,7-10](#) and [P. 7-12](#)  
Saving and recalling sequence data [P.11-18](#) and [P. 11-20](#)

4.2.5 Saving a Screenshot

Save the current screen to USB flash memory. This function can be used for tasks such as recording setting information when making an inquiry and creating work instructions.

a) Operation

Press and hold the UNDO key for at least 1 second.

"Screen capture is saved" is displayed and a screenshot file is saved.

b) Save destination

The file is saved in the WF1983ScreenShot folder or WF1984ScreenShot folder in the USB flash memory. The folder is created if it does not exist. The file format of a created file is bmp, the number of colors is 65,000, and the size of one file is 256 KiB. The file name is ScreenShotNNNNN.bmp. The NNNNN at the end of the file name is a number. If you save additional files, NNNNN will be incremented by 1 for each file.

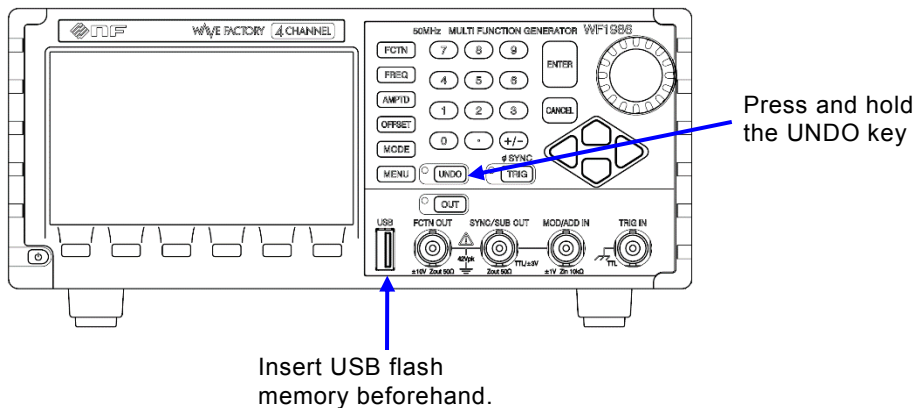



## 4.3 Basic Settings and Operations

### 4.3.1 To Switch between Oscillator and Sequence Oscillation

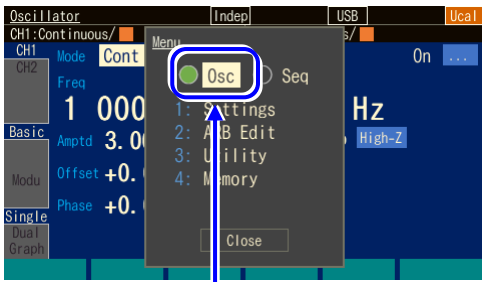

The current operation mode is disolved.

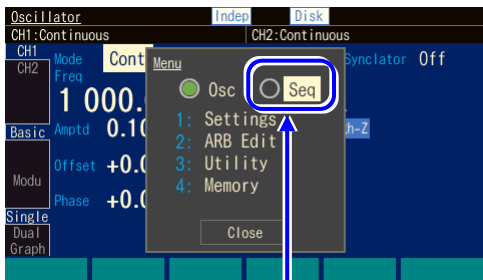

Select [Seq] and then press  
The ENTER key.

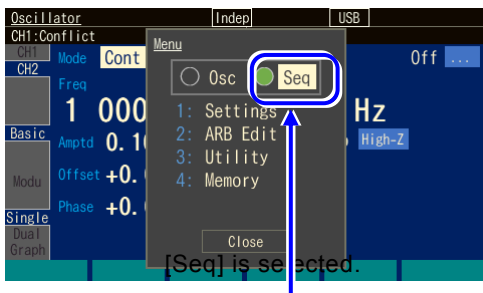

[Seq] is selected.

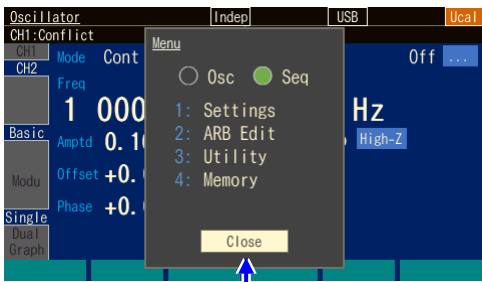

Select [Close] and then  
press the ENTER key.

1. Press the MENU key to display the top menu.  
The example on the left is for oscillator.  
Try switching this to sequence.

2. Select [Seq] with the right/left arrow keys or the modify knob and then press the ENTER key.

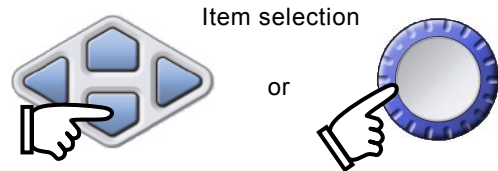

3. Press the ENTER key and confirmation dialog will appear. Press [OK] to enter sequence mode and move the button position to [Seq].

4. Select [Close] item with the up/down arrow keys or the modify knob and then press the ENTER key to close the top menu.

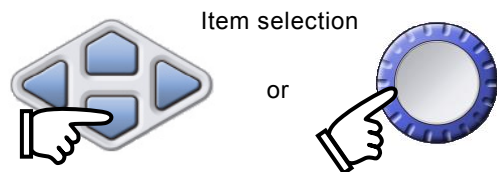

4.3.2 To Change Frequency, Amplitude, and Other Values

a) To change a value with the up/down arrow keys (or the modify knob)



The frequency is selected.  
The current frequency value is displayed

1. Select the desired item with the arrow keys or the modify knob.

In the example on the left, the frequency [Freq] field is selected.

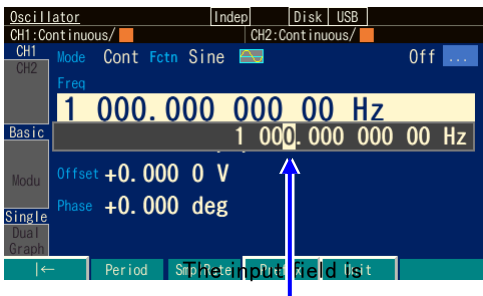
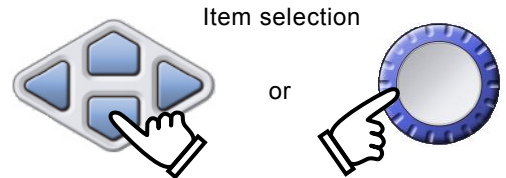

2. Press the ENTER key to open the input field to change the current value. In this state, you can enter a value using the numeric keypad.

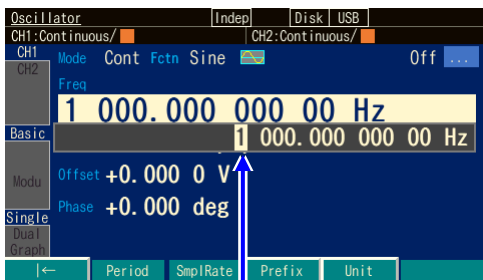

The 1 kHz digit is to be changed.

3. Press the left/right arrow keys to move the cursor to the digit to change the value. In the example on the left, the cursor is moved to the 1 kHz digit.

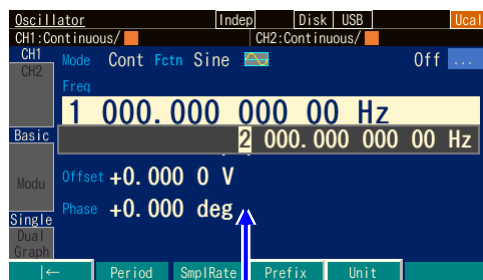

The value of the digit is now 2.

4. Increment or decrement the value of the digit using the up/down arrow keys or the modify knob. In the example on the left, the value is changed to 2 kHz. The change is immediately reflected in the output.

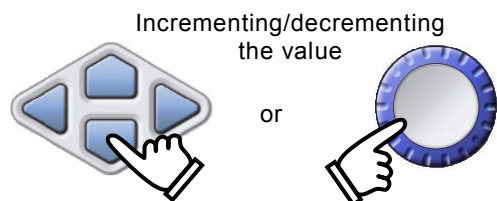

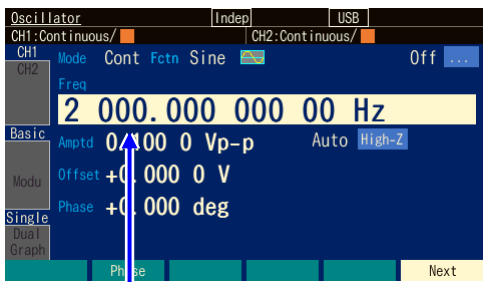

The input field is closed

5. Press the ENTER key to close the input field.



If you press the CANCEL key instead of the ENTER key, the changed value is discarded and the setting before the change is restored.

**b) To change a value with the numeric keypad [0]...[9]**

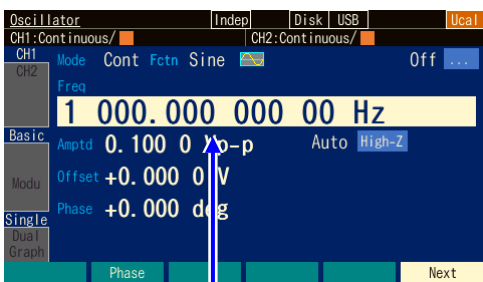

The frequency is selected.  
The current frequency value is displayed.

1. Select the desired item with the arrow keys or the modify knob.  
In the example on the left, the frequency [Freq] field is selected.

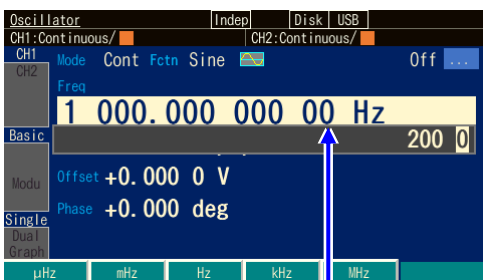
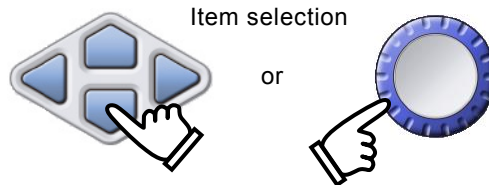

The input field is opened and a value is input

2. Press the numeric keypad to open the input field and enter the numeric value.  
While inputting numeric values, the left arrow key serves as the delete key, and the right arrow key as the zero input key.

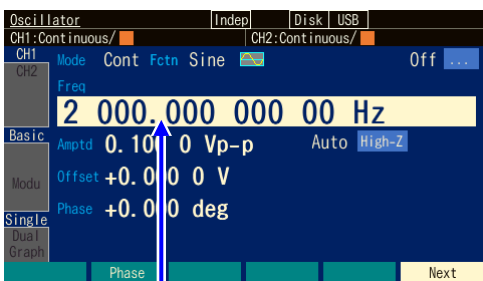
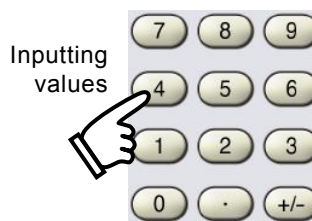

The setting is changed, and the input field is closed.

3. Press the ENTER key or the unit key (soft key) to set the input value and reflect it in the output.  
If you press the ENTER key, the value is set without prefixes such as "k" or "m."



**Check**

If a setting item is displayed on a soft key, you can open the input field for that item by pressing that soft key.

**4.3.3 To Change the Waveform and Oscillation Mode**



The waveform is selected  
The current waveform value is displayed



The selection list is opened.

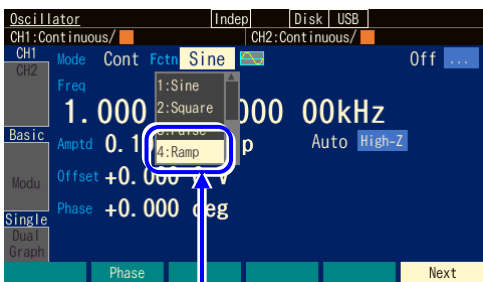

Ramp is selected.



The waveform is set to Ramp

1. Select the desired item with the arrow keys or the modify knob.  
In the example on the left, the waveform [Fctn] field is selected.

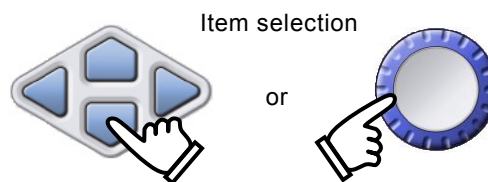

2. Press the ENTER key to open the selection list.



3. Use the up/down arrow keys or the modify knob to move within the selection list.  
In this state, you can specify an item by entering a number from the numeric keypad.

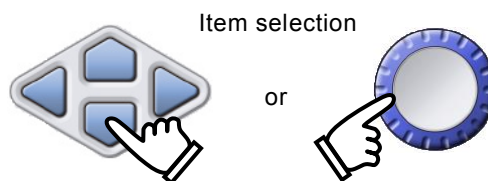

4. Press the ENTER key to set the selected item and reflect it in the output. The selection list closes.

### 4.3.4 Shortcut Keys for Changing Basic Parameters

The selection list or input field for waveform, frequency, amplitude, DC offset, and oscillation mode can be immediately opened by using the corresponding basic parameter shortcut key.

■ Frequency

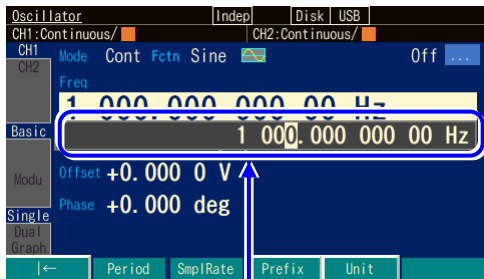

The frequency input field is opened

■ Amplitude

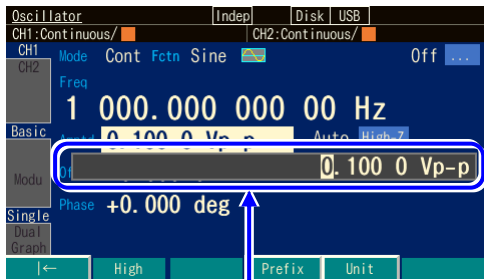

The amplitude input field is opened

■ DC Offset

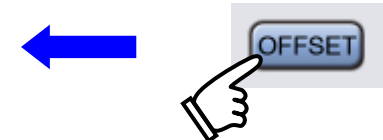
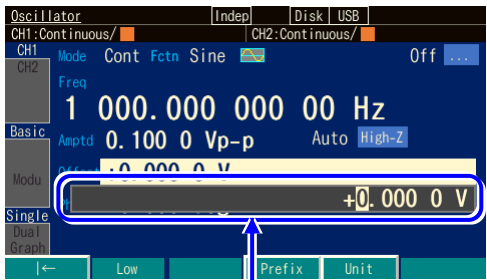

The DC offset input field is opened

■ Oscillation mode

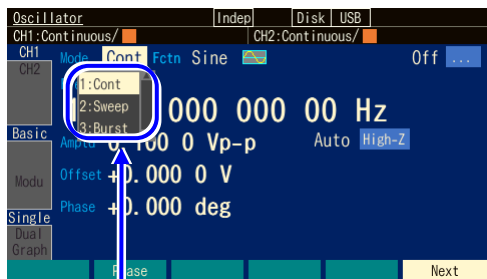

The Oscillation mode input field is opened

### 4.3.5 Functions of ENTER/CANCEL/UNDO Key

#### ■ Functions of ENTER key



The ENTER key can be used to perform the following actions.

- Open the input field or selection list for the selected item.
- Set a value input from the numeric keypad.
- Perform the function of the button displayed on the screen.

#### ■ Functions of CANCEL key



The CANCEL key can be used to perform the following cancellations. However, setting changes cannot be undone with this key once made (to undo them, use the UNDO key in the next section).

- Close an input field or selection list.
- Discard the value input from the numeric keypad.
- Restore the value changed by using the modify knob.
- Close a setting window or dialog box.

#### ■ Functions of UNDO key

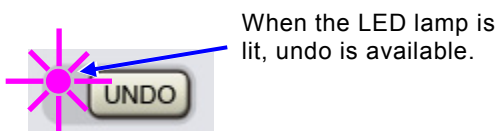

The UNDO key can be used to restore the settings changed by using the ENTER key or the modify knob. This key can restore also a setting change that has been automatically made as a result of the last operation.

When you press the UNDO key again immediately after the undo operation, the setting before the undo operation is restored.

Note that undo may not work for some operations. When undo is available, the LED is lit.

### 4.3.6 To Change the Display Unit

a) To change the unit prefix (k, m, M, etc.)

Frequency is used as an example here. The procedure is the same for amplitude and pulse width.

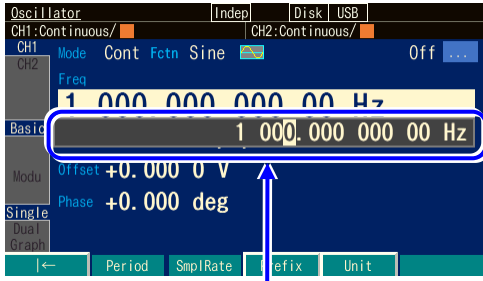

The input field is opened

1. Select frequency and then press the ENTER key to open the input field.



Pressing [Prefix] moves the cursor to before "Hz."

2. Press the [Prefix] soft key to move the cursor to before "Hz."

You can also press the right arrow key to move the cursor to before "Hz."

3. Use the up/down arrow keys or the modify knob to change the unit to MHz, kHz, Hz, mHz, or  $\mu$ Hz. This just changes the display unit and decimal point position. The setting value itself does not change.



Changing prefix

or

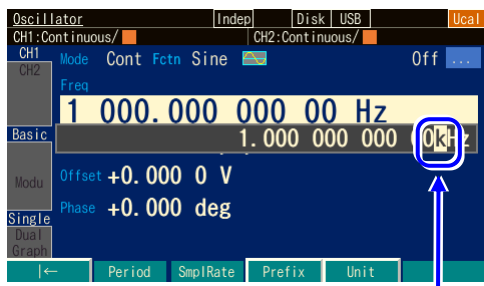

kHz display

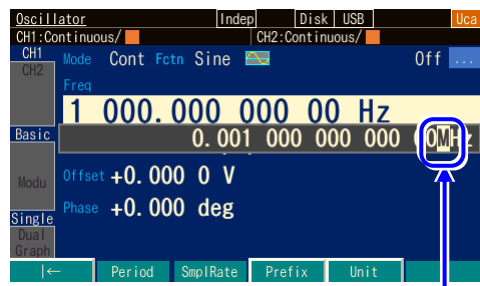

MHz display

b) To change Vp-p, Vrms, user-defined unit, etc.

Amplitude is used as an example here. The procedure is the same for frequency and pulse width.

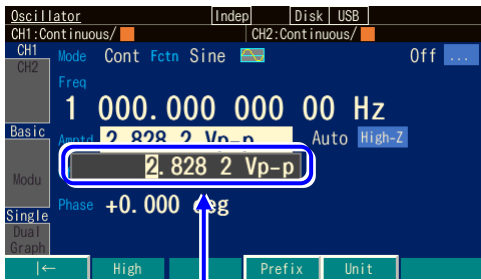

The input field is opened

1. Select amplitude and then press the ENTER key to open the input field.

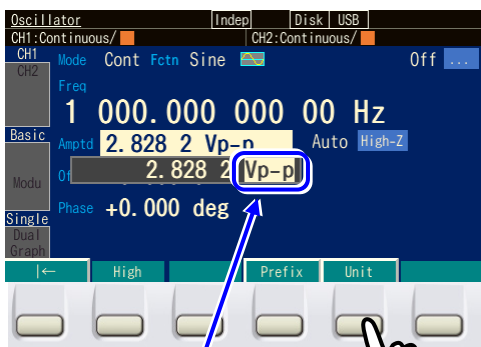

Press the [Unit] to move the cursor to "Vp-p."

2. Press the [Unit] soft key to move the cursor to "Vp-p."

You can also press the right arrow key repeatedly to move the cursor to "Vp-p."

3. Use the up/down keys or the modify knob to change the units to Vrms, dBV, or a user-defined unit (in the case of sine wave and load impedance Hi-Z). This just changes the display unit and numeric value. The output value itself does not change.

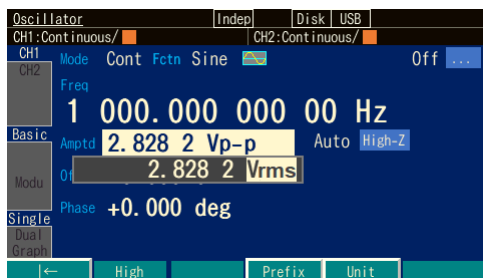

Vrms display



dBV display

Also refer to the following four items:

- Changing the frequency and cycle time [P.4-33](#), [P.4-34](#).
- Changing the amplitude unit (Vp-p, Vpk, Vrms, dBm, dBV) [P.4-37](#).
- Changing the pulse wave time and duty [P.4-50](#).
- Setting user-defined units [P.12-2](#).



4.3.7 CH1/CH2 Switching Key and Active Channel (WF1984 Only)

Each time the CH1/CH2 switching key is pressed, the channel to be set is switched alternately.

This key is disabled on the setting screens that are not dependent on the channel.

The channel that is to be set is called the "active channel" in this product. In the burst oscillation and other modes, the TRIG key works for the channel whose display is active. Active settings are saved even when moving to setting screens that are not dependent on the channel.



CH1/CH2 switching key

CH1 active  
(CH1 is the setting target)

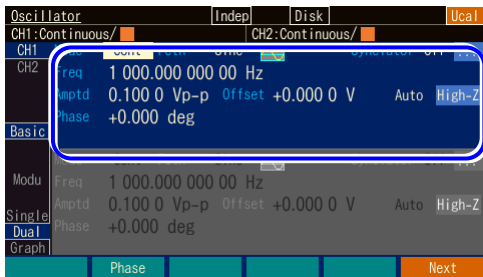

CH2 active  
(CH2 is the setting target)

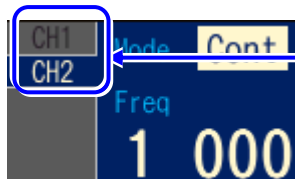
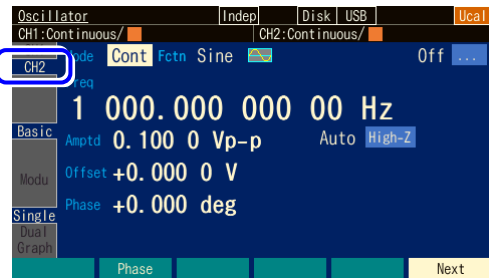
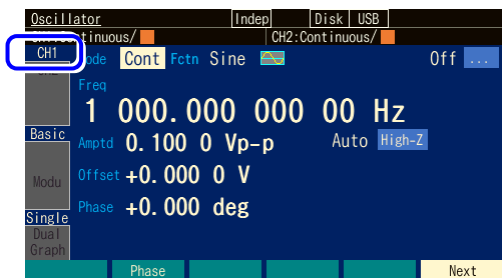
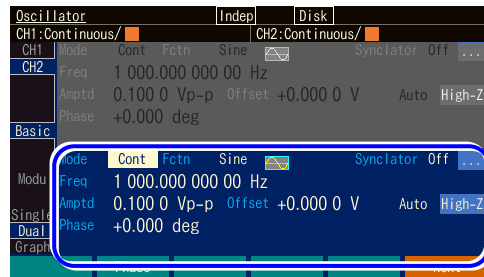

The channel that is currently active is displayed at the top of the tab area in the Oscillator screen

### 4.3.8 Operations Available on Utility Screen

a) Displaying the Utility screen



When the MENU key is pressed, the top menu opens. Select [UTILITY] and then press the ENTER key. The Utility screen opens.

b) Utility screen configuration

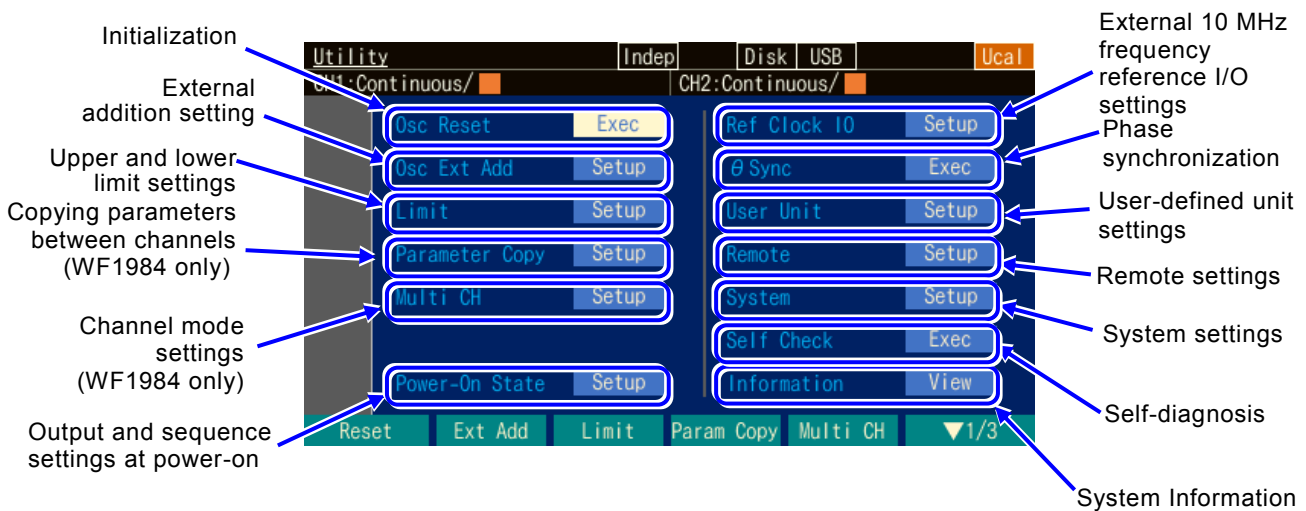

- **Initialization [Reset]**  
Performs a reset of the setting values. [P.4-26](#)  
For a list of the initial settings, see “16 List of Initial Settings.”
- **External addition settings [ExtAdd]**  
Sets the external addition gain. Available settings are off,  $\times 0.4$ ,  $\times 2$ , and  $\times 10$ . For the setting procedure, [P.4-46](#)
- **Upper and lower limit settings [Limit]**  
Sets the upper limit and lower limit of parameters. [P.4-57](#)
- **Copy parameters between channels [Parameter Copy] (WF1984 only)**  
Copies the settings between channels. [P.8-3](#)
- **Channel mode settings [Multi CH] (WF1984 only)**  
Sets the type of 2-channel coordination operation, and on/off for the 2-channel equivalence setting. For how to set the coordination operation, refer to “8 Convenient Use of 2-channel Equipment” [P. 8-5](#).  
This setting is disabled with sequence oscillation.
- **Settings at power-on [Power-On State]**

Configures the output on/off settings and automatic sequence start on/off settings for when the power is turned on. [P.4-28](#)

- **External 10 MHz frequency reference I/O settings [Ref Clock IO]**  
Enables/disables reference input and switches the output of reference output on/off. This also indicates whether a valid signal is being input to the reference input.  
For the setting procedure, [P.10-4](#)
- **Phase synchronization operation [ $\phi$  Sync]**  
Handles the synchronization between multiple units when they are connected together and synchronization between channels on the WF1984. [P.8-6, P.9-4](#)
- **User-defined unit settings [User Unit]**  
Sets the user-defined units. [P.12-2](#)
- **Remote settings [Remote]**  
Selects GPIB, USB, or LAN. Set the address when GPIB is selected, and the IP address and subnet mask when LAN is selected. Also displays the USB ID. [P.13-2](#)
- **System settings**  
Sets the operation sound.  
Sets the operation sound, base color, and graph color.  
Sets the display backlighting.  
For the setting procedure, [P.13-3](#)
- **Self-diagnostics [Self Check]**  
Performs an internal status check. [P. 13-3](#)  
Execute this after initializing the settings.
- **System Information [Information]**  
Displays the model name, firmware version, and last adjustment date. [P. 13-4](#)

### 4.3.9 To Restore Initial Settings

Restore the initial settings from the Utility screen. For a list of the initial settings, see P.16-2 and 16-3.

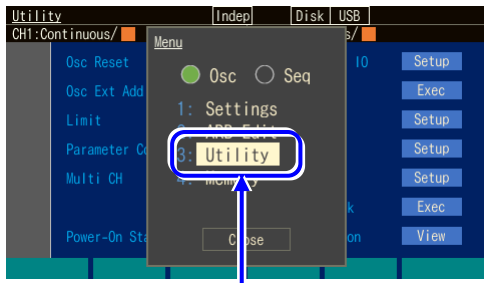

In the top menu, select [Utility] and then press the ENTER key

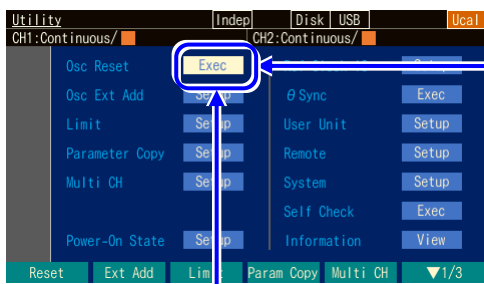

In the Utility screen, select [Reset] and then press the ENTER key.

1. Press the MENU key to display the top menu. Then, press the [UTILITY] soft key. The Utility menu opens. The screen on the left is an example for oscillator.

2. Select [Osc Reset] and then press the ENTER key. This initializes the settings.

### 4.3.10 To Restore Factory Default Settings

Restore the factory default settings from the Utility screen. The settings in “16.3 Other Factory Default Settings” can also be initialized in addition to the initial settings in the previous section.

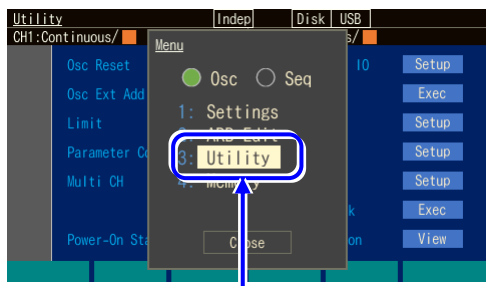

In the top menu, select [Utility] and then press the ENTER key.

1. Press the MENU key to open the top menu in the setting area. Then, press the [UTILITY] soft key. The Utility menu opens. The screen on the left is an example for oscillator.

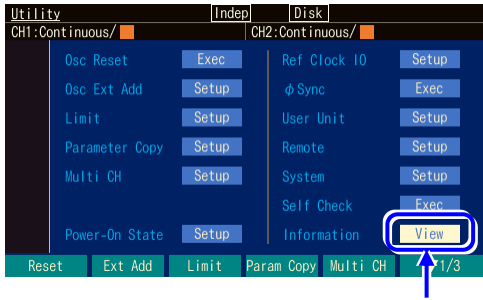

In the Utility screen, select [Information] and then press the ENTER key.

- In the Utility screen, select [Information] and then press the ENTER key.

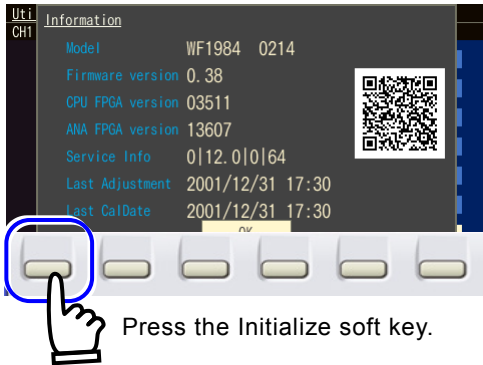

Press the Initialize soft key.

- Press the Initialize soft key on the very left.

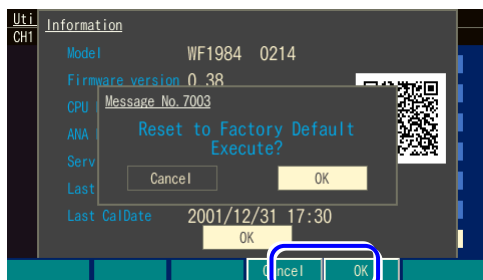

Select OK and then press the ENTER key.

- Select OK and then press the ENTER key to start processing. The settings will become the factory default settings after a few minutes.

### 4.3.11 Output On/Off

#### a) Key operation in the panel screen

The waveform output is switched on/off each time the waveform output on/off key (OUT) key is pressed. The lamp on the left side of the key is lit when output is on.

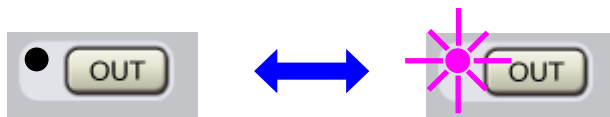

Output on/off

The output terminal is released when the output is turned off. The output impedance is 50Ω when this is turned on. The synchronization/sub output is always on regardless of the

waveform output on/off setting.

✓ **Check**

The on/off setting for waveform output uses a mechanical relay. This causes chattering to occur when the waveform output is switched on or off. Please use the trigger burst or gate oscillation mode when connecting to equipment which might malfunction due to chattering. 📖 P.4-109, P.4-114

✓ **Check**

The relay inside the instrument for switching output on/off is a part with a limited life. Switching output on/off frequently may lead to a failure early and even within the warranty period of the product. The life expectancy of the relay is about 100,000 times.

Also consider using the trigger burst and gate oscillation modes instead of on/off. 📖 P.4-109, P.4-114

**b) Power-on status setting**

Specify whether to turn waveform output on/off and perform sequence oscillation when the power is turned on.

You can select from the following three options.

- **Off [Off]**

Waveform output turns off.

The instrument starts up in oscillator mode (not in sequence oscillation mode).

- **On [On]**

Waveform output turns on.

The instrument starts up in sequence oscillation mode.

- **Restoring last settings [Last State]**

This operation depends on how the power was previously shut off.

If the power was turned off using the power switch on the panel last time

The settings before the last power-off are restored.

If the power was turned off by cutting off the power supply last time

The output will remain off.

The instrument starts up in oscillator mode (not in sequence oscillation mode).

This is the case when you collectively turn on/off the power supply for this product and other devices which are mounted in a rack.

Select the setting on the Utility screen.

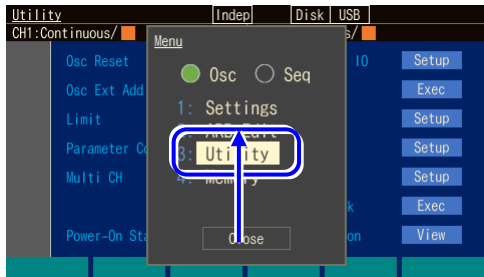

In the top menu, select [Utility] and then press the ENTER key

1. Press the MENU key to displays the top menu window. Then, press the [UTILITY] soft key. The Utility menu opens.

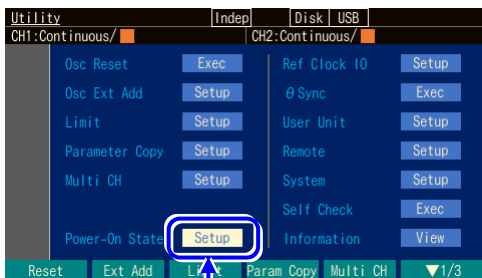

In the Utility screen, select [Power-On State] and then press the ENTER key

2. Select [Power-On State] in the Utility screen and then press the ENTER key.

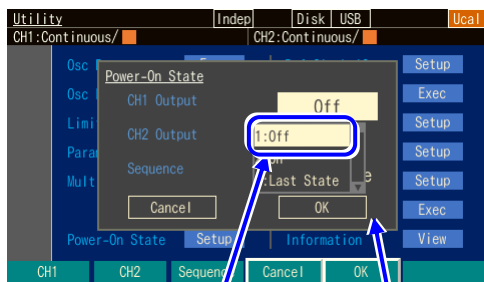

Set the output setting condition.

The window for setting the output at power-on opens.

3. When the Power-On State window opens, select the desired output setting and then press the ENTER key. The selection list of the output setting conditions is opened. Select the desired condition and then press the ENTER key.

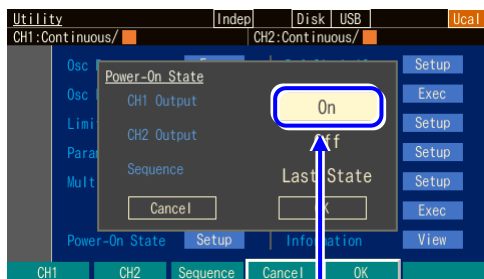

Select [OK] and then press the ENTER key.

4. When the power-on output setting is completed, select [OK] at the bottom of the window, and then press the ENTER key. The change of the power-on output setting is applied, and the window is closed. When you do not want to apply the change of the power-on output setting, select [Cancel] at the bottom of the window and then press the ENTER key, or press the CANCEL key.

### 4.3.12 To Use USB Flash Memory

In the store / recall screen of setting, arbitrary waveform, and sequence settings, switch the operation target by tab selection to internal memory or USB flash memory. To select the operation target, switch the screen using the tabs.

**a) To switch the storage and reading destination**

"DISK" is displayed on the screen when USB flash memory is inserted into the front panel. Select the USB tab and press the ENTER key in that state to change the operation target to USB flash memory.

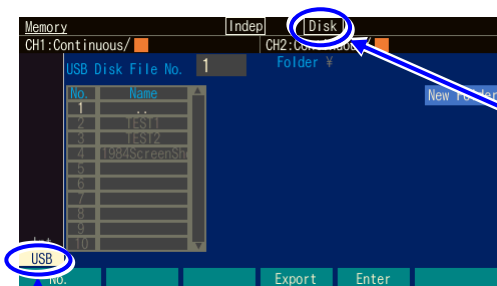

When USB flash memory becomes available, [DISK] is displayed.

Select internal memory or USB flash memory.



## 4.4 Setting for Main Items

This section describes how to set the main items that are set in the Oscillator.

When you press the MENU key while another screen is displayed, the Top menu is displayed. Select [Settings] and then press the ENTER key.

We explain by using the text display screen (1-channel display) in the continuous oscillation mode as an example.

### 4.4.1 Text Display Screen in Continuous Oscillation Mode

The screen to set the basic output waveforms.

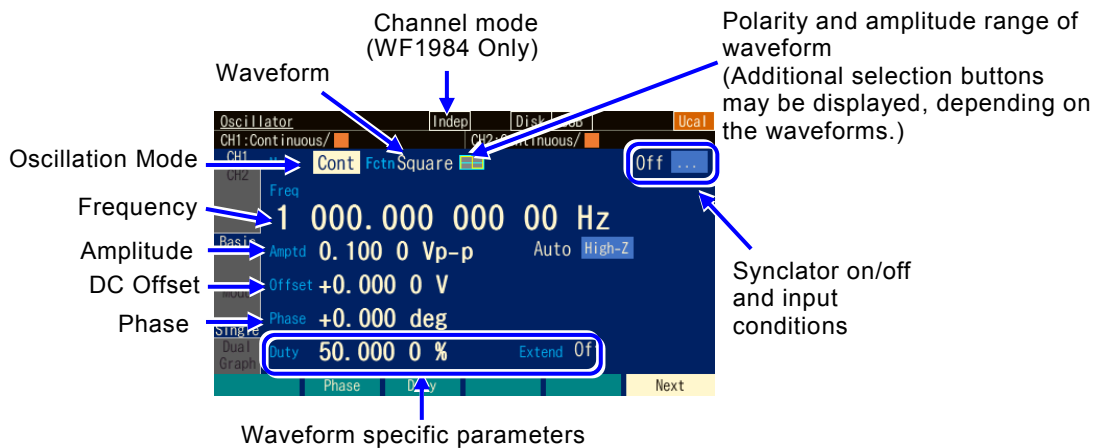

### 4.4.2 To Set Oscillation Mode

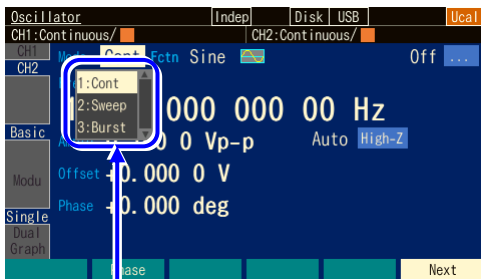

The oscillation mode selection list is opened.

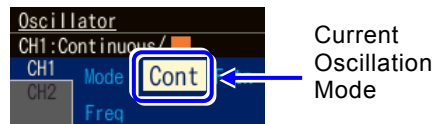

1. Press the MODE key or use the arrow keys and modify knob to select the Mode field. Pressing the ENTER key will open the oscillation mode selection list.

2. Select the desired oscillation mode from the selection list and then press the ENTER key to reflect it in the output.

You can also enter the number of the desired oscillation mode displayed in the selection list from the numeric keypad to reflect it in the output.

This can also be set by entering a number from the numeric keyboard while just the [Mode] field is selected (selection list is not open).

Any of the three modes of continuous (CONT), sweep (Sweep), and burst (Burst) can be selected for the oscillation mode. If you want to perform modulation, see P.4-63

## 4.4.3 To Set Waveforms

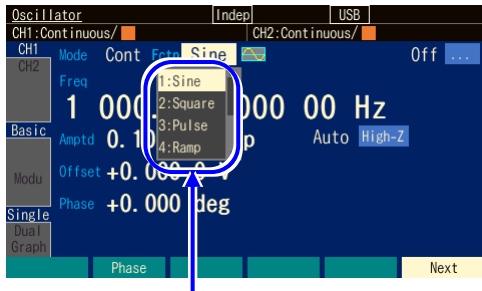

Waveform selection list

1. Press the FCTN shortcut key to open the waveform selection list.  
Or, select the [Fctn] field and then press the ENTER key to open the selection list.

2. Select the desired waveform from the selection list and then press the ENTER key to reflect it in the output.

You can also enter the number of the desired waveform displayed in the list from the numeric keypad to set it and reflect it in the output.

This can also be set by entering a number from the numeric keypad while just the [Fctn] field is selected (selection list is not open).

When you set the waveform to an arbitrary waveform, the arbitrary waveform stored in the main unit is selected.  P.4-61

#### Check

When the waveform is switched, a waveform with transient disturbance will be output because the waveform memory data is rewritten. To change a waveform, it will take up to approximately 0.5 second with an arbitrary waveform of the built-in waveforms and control point method and approximately 2 seconds per 1 MiW with an arbitrary waveform of array format.

## 4.4.4 To Set Frequency

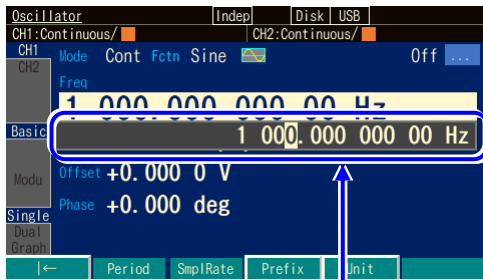

Frequency input field

1. Press the FREQ shortcut key to open the frequency input field. Or, select the [Freq] field and then press the ENTER key.

If [Period] is displayed for the [Freq] field because not the frequency but the period is displayed, press and hold down the FREQ key or press the [Freq] soft key. The display switches to the frequency display.

2. Select the digit to be changed with the right or left arrow key, and then use the up or down arrow key or the modify knob to increment or decrement the value. The change is immediately reflected in the output.  
Or use the numeric keypad to enter the value. Press the ENTER key or the unit key (soft key) ( $\mu\text{Hz}$ ), [mHz], [Hz], [kHz], or [MHz]) to set the input value and reflect it in the output. When the ENTER key is used, Hz is set as the unit.

#### ✓ Check

- The lower limit is 0.01  $\mu\text{Hz}$  to ensure the frequency setting range is compatible with the previous model. To set the lower limit to 0 Hz  $\Rightarrow$  P.4-57
- With an arbitrary waveform or parameter-variable waveform, oscillation is resumed from the set phase if the frequency is changed. Please note that the phase will become discontinuous.

### 4.4.5 To Set Period

The period can be set instead of the frequency.

The following two methods are available to change from frequency display to period display:

- Changing to period display using the [Freq] / [Period] soft key

The input field of frequency opens. When the current frequency is displayed, the [Period] soft key is displayed. Press the [Period] soft key to open the period input field and change the display from [Frequency] to [Period].

The [Period] soft key changes to [Freq]. Press the [Freq] soft key to open the input field of frequency.

- Changing to period display by pressing and holding down the FREQ key

While the frequency input field is not open, press and hold down the FREQ shortcut key to open the period input field.

While the frequency or period input field is open, the display switches between frequency display and period display each time the FREQ key is pressed and held down.

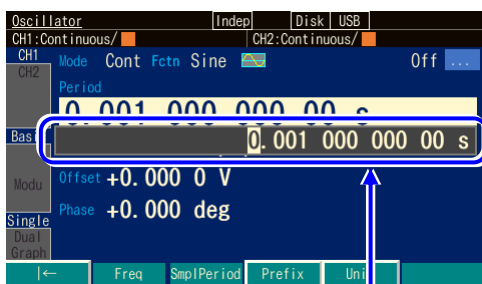

Period input field

When the input field of period appears, configure the setting in the same way as for the frequency. When a number is entered with the numeric keypad, the unit key for the period setting is displayed on the soft key. When display is changed to period display, it changes as follows.

Item Name: Freq → Period

Unit display: Hz → s

Soft keys: Period → Freq

#### ☞ Check

With an arbitrary waveform or parameter-variable waveform, oscillation is resumed from the set phase if the period is changed. Please note that the phase will become discontinuous.

#### 4.4.6 To Set Phase

With oscillator, a virtual reference phase is held inside the unit and that reference phase with the value set in [Phase] added to it is output.

##### a) Setting procedure

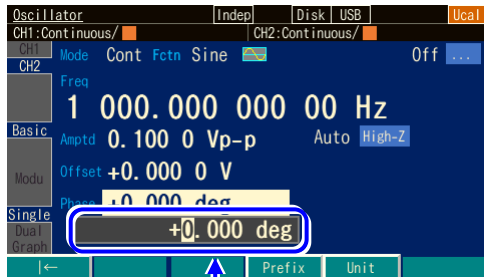

Phase input field

1. Select the [Phase] field and then press the ENTER key to open the phase input field. Or press the [Phase] soft key to open the phase input field.

2. Select the digit to be changed with the right or left arrow key, and then use the up or down arrow key or the modify knob to increment or decrement the value. The change is immediately reflected in the output.

Or use the numeric keypad to enter the value. Press the ENTER key or the unit key (soft key) [deg] to set the input value. When the ENTER key is used, deg is set as the unit.

##### b) Items that can be changed in the phase setting

The following items can be changed in the phase setting.

- The phase difference between the reference phase synchronous output and waveform output can be changed.

The figure on the right shows an example of a phase setting of +90 degrees. At this time, the zero relative position of waveform output precedes 90 degrees from the rising position of the reference phase synchronous output.

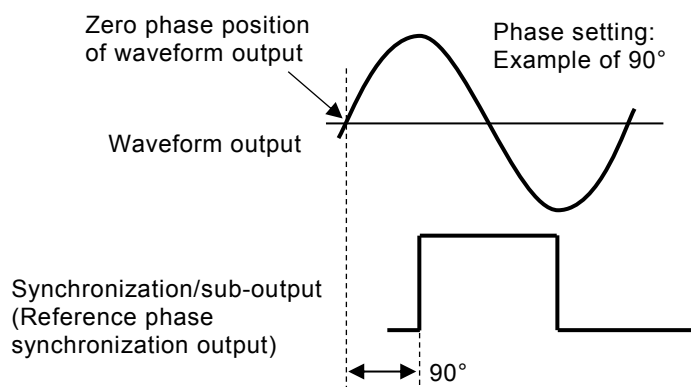

■ Phase reference point of pulse wave

In the case of a pulse wave, the phase reference point is not the center of the transition part but the point where the transition begins.

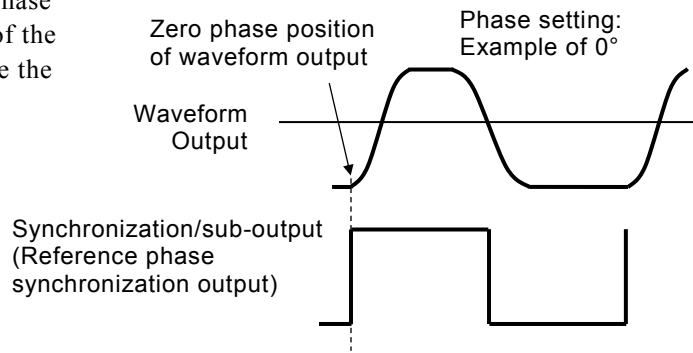

■ The oscillation start/stop phase can be changed in burst oscillation and gated single sweep.

The figure on the right shows an example of the burst oscillation at the oscillation start/stop position of  $+30^\circ$ . At this time, the oscillation starts at a  $+30^\circ$  degree position, and also stops at a  $+30^\circ$  degree position. Burst oscillation  $\Rightarrow$  P.4-103, Gated single sweep  $\Rightarrow$  P.4-86.

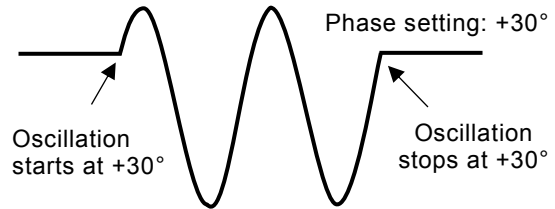

■ The phase difference between channels can be changed in synchronous oscillation and 2 phase oscillation (WF1984 only)

The difference between the phase settings of each channel is the phase difference between the channels. When [Phase setting of CH1 minus Phase setting of CH2] is negative, the waveform of CH2 precedes the waveform of CH1 as shown in the following figure.

For synchronous oscillation and 2-phase oscillation see  $\Rightarrow$  P.8-6, P.8-7

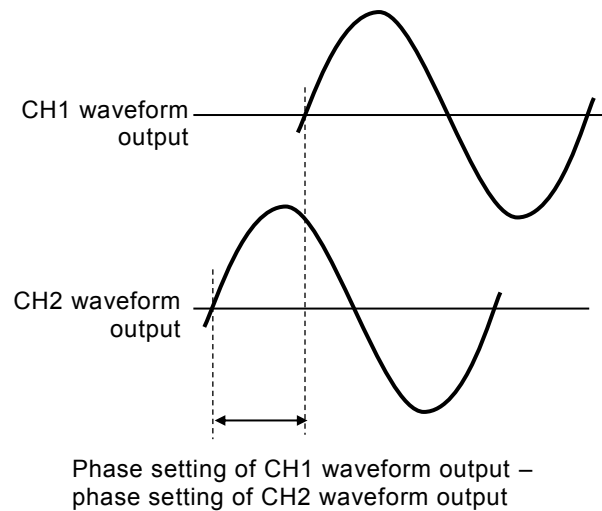

■ Phase difference between waveform and sub output can be changed (modulation is off or when using external modulation)

The difference in phase settings between the waveform output and sub waveform becomes the phase difference between the outputs. The mutual relationship is the same as explained in the previous section. For the sub waveform phase settings,  $\Rightarrow$  P.4-128

### Check

With an arbitrary waveform or parameter-variable waveform, note that changing the phase will cause a waveform with transient disturbance to be output because waveform data will be rewritten to the waveform memory.

The change will take approximately 0.5 second with a parameter-variable waveform, and approximately 2 seconds with an arbitrary waveform of array format.

## 4.4.7 To Set Amplitude

### a) Setting procedure

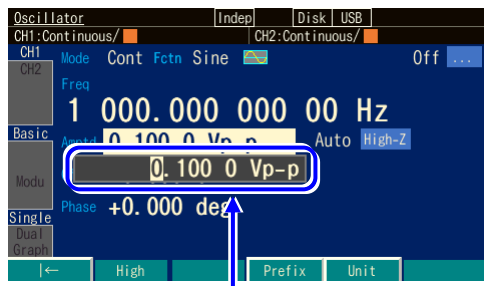

Amplitude input field

1. Press the AMPTD shortcut key to open the amplitude input field. Or select the [Ampltd] field and then press the ENTER key. If [High] is displayed in the [Ampltd] field because not the amplitude but the high level is displayed, press the AMPTD key again.

2. Select the digit to be changed with the right or left arrow key, and then use the up or down arrow key or the modify knob to increment or decrement the value. The change is immediately reflected in the output. Or use the numeric keypad to enter the value. Press the ENTER key or the unit key (soft key) to set the input value and reflect it in the output.

### b) To change units (Vp-p, Vpk, Vrms, dBV, dBm, user-defined unit)

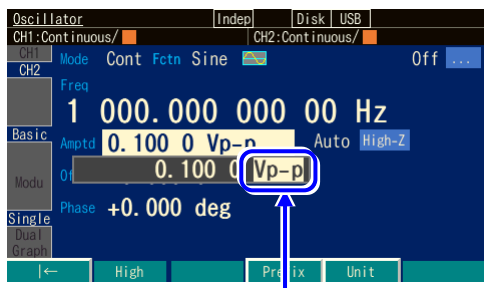

Move the cursor to the unit position.

1. When the input field of the amplitude opens, press the [Unit] soft key to move the cursor to the unit position at the right end.
2. The unit can be changed by using the up or down arrow key or modify knob. Only the display unit is changed as the actual output value is not changed.

c) Available units differ depending on the waveform

Vp-p, Vpk, Vrms, dBV, dBm, and user-defined units can be used as the units for amplitude. However, the waveforms to which the units can be applied are restricted as follows (DC is excluded from amplitude settings).

Unit	Applied waveform
Vp-p	Standard waveforms with amplitude range of $\pm$ FS and arbitrary waveforms
Vpk	Standard waveforms with amplitude range of 0/+FS, -FS/0 and arbitrary waveforms
Vrms	Sine wave and noise
dBV	Sine wave and noise. 0 dBV shall be 1 Vrms.
dBm	Sine wave and noise. The voltage that is 1 mW at the specified load impedance shall be 0 dBm. For example, when the load impedance is set as 50 $\Omega$ , 0 dBm=223.6 mVrms/50 $\Omega$ . This is not available when the load impedance is set as Hi-Z.
User-defined unit	All waveforms. For user-defined units, $\Rightarrow$ P.12-2

d) Restriction on AC + DC

The maximum total value of AC amplitude and DC offset is restricted to  $\pm$ 10.5 V/open.

For example, when the AC amplitude is 5 Vp-p/open, DC offset is restricted to the range from -8 V/open to +8 V/open.

The maximum value also differs depending on the range setting of output voltage or external addition setting.  $\Rightarrow$  P.4-42, P.4-47

If the setting range restriction values of voltage are other than the defaults, observe those settings.  $\Rightarrow$  P.4-57

4.4.8 To Set DC Offset

a) Setting procedure

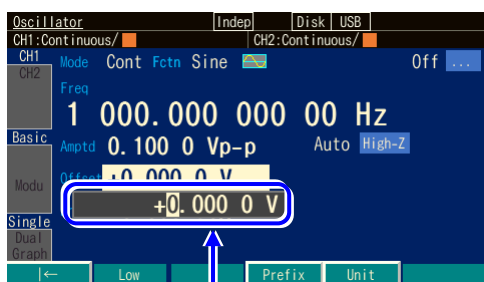

DC offset input field

1. Press the OFFSET shortcut key to open the DC offset input field. Or select the [Offset] field and then press the ENTER key to open the DC offset input field.  
If [Low] is displayed for the [Offset] field because not the DC offset but the low level is displayed, press the OFFSET key again. The display switches to DC offset display.

2. Select the digit to be changed with the right or left arrow key, and then use the up or down arrow key or the modify knob to increment or decrement the value. The change is immediately reflected in the output.

Or use the numeric keypad to enter the value. Press the ENTER key or the unit key (soft key) to set the input value and reflect it in the output.



**b) Restriction on AC + DC**

The maximum total value of AC amplitude and DC offset is restricted to  $\pm 10.5$  V/open.  
 For example, when the AC amplitude is 5 Vp-p/open, DC offset is restricted to the range from -8 V/open to +8 V/open.

The maximum value also differs depending on the range setting of the output voltage or external addition setting.

☞ P.4-42, P.4-47

If the setting range restriction values of voltage are other than the defaults, observe those settings. ☞ P.4-57

**4.4.9 To Set Output Level with High/Low Level**

The output level can be set with the top end value (high level) and the bottom end value (low level) of a waveform instead of amplitude and DC offset.

**a) To change amplitude/DC offset display to high/low display**

There are the following three methods to change the amplitude/DC offset display to high/low display:

- Changing to high/low display by using the [High]/[Low] soft key
  - When the input field of amplitude or DC offset opens, the [High] or [Low] soft key is displayed. When this soft key is pressed, the input field of high level or low level opens, and the display is changed from [Amptd] or [Offset] to [High] or [Low] respectively. The [High] or [Low] soft key changes to [Amptd] or [Offset] respectively. When the [Amptd] or [Offset] soft key is pressed, the input field of amplitude or DC offset is opened.
- Changing to high/low display by pressing and holding down the AMPTD key
  - While the amplitude input field is not open, press and hold down the AMPTD shortcut key to open the high level input field. While the high level input screen is open, the display switches between amplitude/DC offset display and high/low display each time the AMPTD key is pressed and held down.
- Changing to high/low display by pressing and holding down the OFFSET key
  - While the DC offset input field is not open, press and hold down the OFFSET shortcut key to open the low level input field. While the low level input field is open, the display is switched between amplitude/DC offset display and high/low display each time the OFFSET key is pressed and held down.

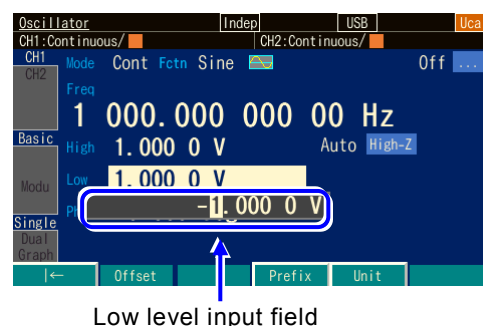
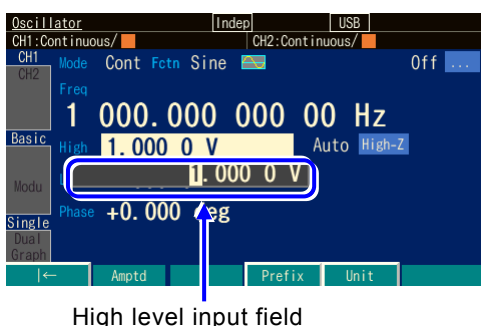

When the input field of high level or low level is open, the settings in the same way as for DC offset. When a numeric value is entered by using the numeric keypad, the unit key for high level/low level setting is displayed on the soft key.

When changing to the high level/low level display, the display is changed as follows.

Item Name: Amptd → High, Offset → Low

Unit display: Vp-p, Vpk, Vrms, dBV, dBm, V → V

Soft keys: High → Ampl, Low → Offset

**b) Restriction on AC + DC**

Depending on the oscillation frequency, high level and low level are restricted to a range of -10.5 V to +10.5 V/open.

The maximum range also differs depending on the range setting of the output voltage or external addition setting.

☞ P.4-42, P.4-47

If the setting range restriction values of voltage are other than the defaults, observe those settings. ☞ P.4-57

**4.4.10 To Set Waveform Polarity and Amplitude Range**

**a) Setting procedure**



Select the polarity/amplitude range icon to display the current polarity and amplitude range settings

Select the Polarity/Amplitude Range icon and then press the ENTER key.

1. Select the polarity/amplitude range icon on the right of the waveform name indication to display the current polarity and amplitude range settings.  
Press the ENTER key to open the selection list for the polarity/amplitude range.

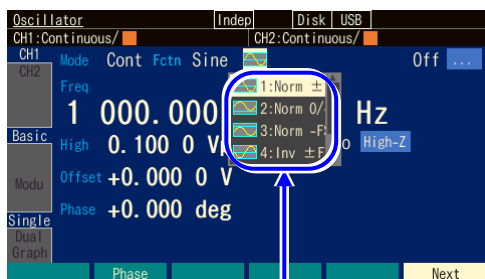

The selection list for the polarity/amplitude range is opened.

2. Select the desired polarity and amplitude range from the selection list and then press the ENTER key to reflect it in the output.  
You can also enter the numbers of the desired polarity and amplitude range displayed in the list from the numeric keypad to set them and reflect them in the output.

**b) Polarity and amplitude range**

You can invert the polarity or change the amplitude range to single polarity. The following figure shows the cases with sine waves:

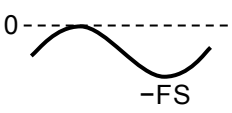
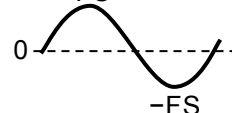
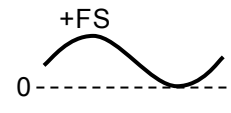
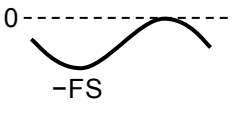
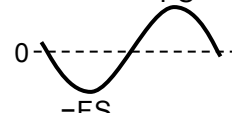
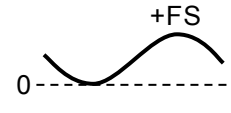
Polarity	Amplitude range		
	-FS/0	$\pm$ FS	0/+FS
Normal [Normal]			
Invert [Inv]			

In the case of inversion, only the waveform is inverted, and the DC offset sign of the output remains unchanged.

 **Check**  
The polarity and amplitude range settings are separate settings for each waveform.

**c) How to determine amplitude range**

Take note of how waveforms change when the amplitude is changed, and then determine the amplitude range.

By default, a waveform which oscillates to both polarities is set to  $\pm$  FS, and a unipolar waveform is set to 0/+FS.

■ **Example with sine wave and an amplitude range of  $\pm$  FS**

When the amplitude is changed, the amplitude of the waveform changes to positive and negative symmetry based on the DC offset position.

Normally, in the case of a waveform which oscillates between the two polarities with zero as the center, it is more convenient to set the amplitude range to  $\pm$ FS.

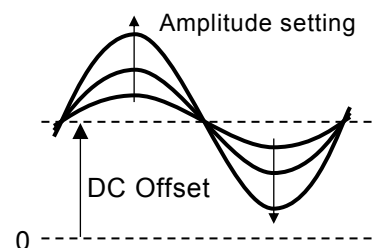

■ **Example with a Gaussian pulse and an amplitude range of 0/+FS**

When the amplitude is changed, only the positive peak of the waveform will change in reference to the DC offset position. The amplitude will change in reference to the waveform's base.

Normally, in the case of a unipolar waveform, it is more convenient to set the amplitude range to 0/+FS or -FS/0.

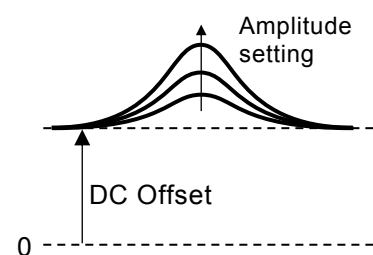

The amplitude will change in reference to the top of the waveform when the amplitude range is set to -FS/0.

(Gaussian pulses are waveforms including parameter-variable waveforms.)

**d) Restriction by amplitude range**

- When the amplitude range is -FS/0 or 0/+FS, the maximum amplitude is half of  $\pm FS$ .
- When the amplitude range is -FS/0 or 0/+FS, this is equivalent to using only the upper or lower half of the waveform memory. Therefore, the amplitude resolution power decreases by 1 bit compared with  $\pm FS$ .
- The amplitude is set as Vp-p when the amplitude range is  $\pm FS$ , and as Vpk when the amplitude range is -FS/0 or 0/+FS. Both are the nominal size of peak to-peak of waveform.

**4.4.11 How to Use Auto Range/Range Hold for Output Voltage**

Auto-range is selected by default. The optimum range is automatically selected according to the amplitude and DC offset (including high/low level settings) settings. When the range is changed, a transitional voltage is generated. Therefore, it is controlled so as not to be an excessive voltage. If the transitional voltage generated on range switching is undesirable, you can fix the range. However, amplitude accuracy and waveform fineness decrease as the amplitude is reduced with the range fixed.

**a) Setting procedure**

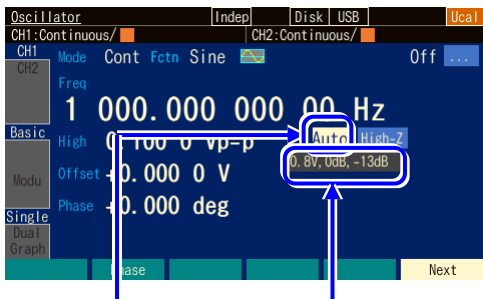

Select the range icon and then press the ENTER key.

When the range icon is selected, the current range is displayed.

1. Select the range field on the right of the amplitude indication to display the current range below the range field. It is expressed as a combination of the maximum output voltage [Vp-p] and the amplitude attenuator. When the ENTER key is pressed, the selection list for range processing is opened.



The selection list for range processing is opened.

2. When [AUTO] is selected, it is set to auto range. Selecting [HOLD] fixes the range at that time. Select the desired range processing, and then press the ENTER key.

#### 4.4 Setting for Main Items

**b) Maximum values of amplitude/DC offset for fixed range**

When a range is fixed, the maximum values of amplitude and DC offset and the external addition gain are fixed as shown in the following table.

Range (maximum output voltage V <sub>p-p</sub> , amplitude attenuator, DC offset attenuator)	Maximum values of amplitude (with no load)	Maximum values of DC offset (with no load)	Maximum values of AC+DC (with no load)	External Addition gain (rated ±1 V)
20 V, 0 dB, 0 dB	21 V <sub>p-p</sub>	±10.5 V	±10.5 V	x10 or Off
20 V, 0 dB, -14 dB		±2.1 V		
20 V, -10 dB, 0 dB	6.641 V <sub>p-p</sub>	±10.5 V		
20 V, -10 dB, -14 dB		±2.1 V		
20 V, -20 dB, 0 dB	2.1 V <sub>p-p</sub>	±10.5 V		
20 V, -20 dB, -14 dB		±2.1 V		
20 V, -30 dB, 0 dB	0.6641 V <sub>p-p</sub>	±10.5 V		
20 V, -30 dB, -14 dB		±2.1 V		
4 V, 0 dB, 0 dB	4 V <sub>p-p</sub>	±2 V	±2 V	x2 or Off
4 V, 0 dB, -14 dB		±0.4 V		
4 V, -10 dB, 0 dB	1.2649 V <sub>p-p</sub>	±2 V		
4 V, -10 dB, -14 dB		±0.4 V		
4 V, -20 dB, 0 dB	0.4 V <sub>p-p</sub>	±2 V		
4 V, -20 dB, -14 dB		±0.4 V		
4 V, -30 dB, 0 dB	0.12649 V <sub>p-p</sub>	±2 V		
4 V, -30 dB, -14 dB		±0.4 V		
0.8 V, 0 dB, 0 dB	0.8 V <sub>p-p</sub>	±0.4 V	±0.4 V	x0.4 or Off
0.8 V, 0 dB, -14 dB		±0.08 V		
0.8 V, -10 dB, 0 dB	0.253 V <sub>p-p</sub>	±0.4 V		
0.8 V, -10 dB, -14 dB		±0.08 V		
0.8 V, -20 dB, 0 dB	0.08 V <sub>p-p</sub>	±0.4 V		
0.8 V, -20 dB, -14 dB		±0.08 V		
0.8 V, -30dB, 0dB	0.0253 V <sub>p-p</sub>	±0.4 V		
0.8 V, -30 dB, -14 dB		±0.08 V		

### 4.4.12 To Set Load Impedance

By matching the setting value of the load impedance to an actual loading condition, the amplitude and DC offset (including the setting according to high level and low level) can be set with the voltage that appears to the load end.

The value of the load impedance can be set to a range of 1  $\Omega$ -10 k $\Omega$ , 50  $\Omega$  or Hi-Z. However, even if the setting value of load impedance is changed, only the displayed amplitude setting value and DC offset display value change. The output voltage when the load is opened does not change.

#### a) Setting procedure

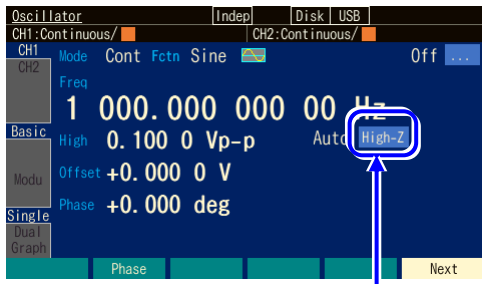

Select the load impedance icon and then press the ENTER key.

1. Select the load impedance icon on the right side of the range field and then press the ENTER key.



Set the load impedance condition.

The window for load impedance setting opens.

2. When the load impedance setting window opens, press the ENTER key again. When the load impedance condition selection list opens, select the desired load impedance condition, and then press the ENTER key. When [Variable] is selected, the load impedance can be set.

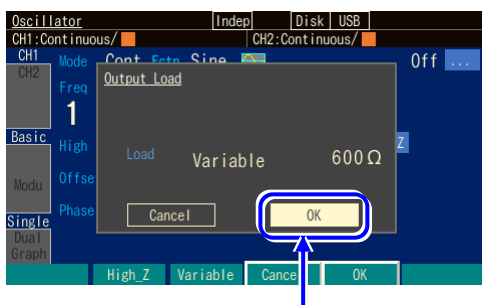

Select [OK] key and then press the ENTER key.

3. When the load impedance setting is completed, select [OK] at the bottom of the window and then press the ENTER key. The change in the load impedance setting is applied. When you do not want to apply the change of the load impedance setting, select [Cancel] at the bottom of the window and then press the ENTER key, or press the CANCEL key.

### b) Conversion formula

Converted by the following formula:

Load impedance setting value:  $R_{load} (\Omega)$

Output voltage when load is opened:  $V_{open}$

Output voltage setting value (load end voltage):  $V_{load}$

$$V_{load} = \frac{R_{load}}{50 + R_{load}} \times V_{open}$$

#### Check

- The output impedance is a constant 50  $\Omega$ .
- Neither the output impedance error nor the output voltage error are corrected. The accuracy specification of the output voltage is the value when there is no load.

### 4.4.13 To Add External Signal

Output can be performed by adding an external signal to the waveform output.

#### a) To Connect addition signal

Connect the addition signal to the external modulation / addition input (MOD/ADD IN) BNC terminal. It is located on the front panel in the case of the WF1983, and the rear panel in the case of the WF1984.

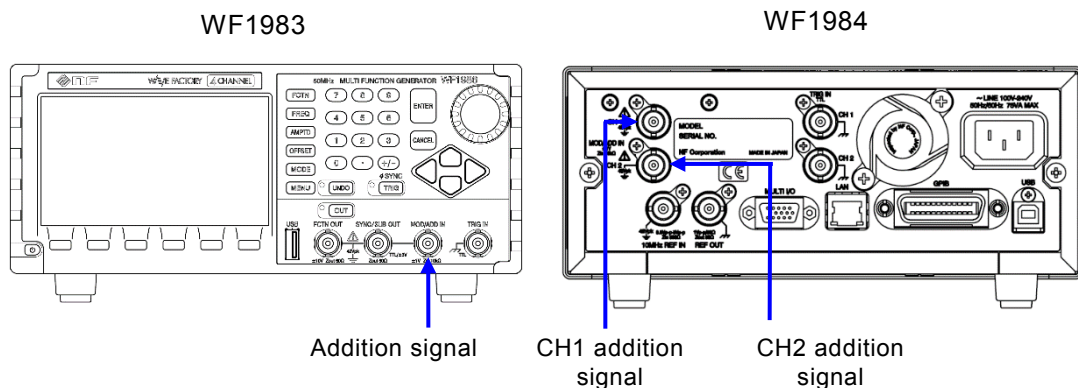

For the input characteristic, see P.3-9.

This BNC terminal is insulated from the enclosure, and has the same ground electrical potential as the waveform output of the same channel. For the floating ground connection, see P.3-15

#### Check

Regardless of the settings, do not input a voltage that exceeds  $\pm 1$  V to the external modulation / addition input (MOD/ADD IN) BNC terminal. The output signal may be disturbed.

b) To enable the addition signal

Set the external addition on the Utility screen.

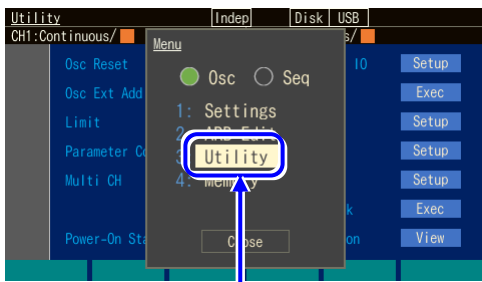

In the top menu, select [Utility] and then press the ENTER key

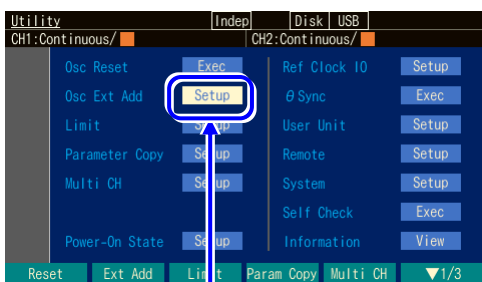

On the Utility screen, select the [Osc Ext Add] field and then press the Enter key.

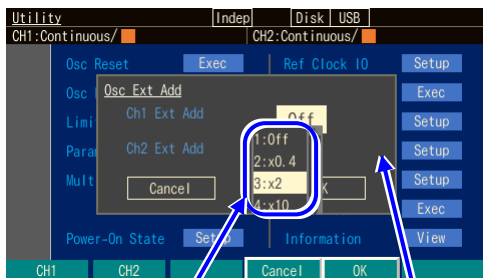

Set the external addition setting.

External addition setting window is opened

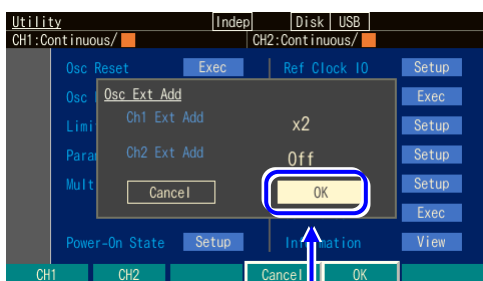

Select [OK] and then press the ENTER key.

1. Press the MENU key to display the top menu window. Then, press the soft key corresponding to [UTILITY]. The Utility menu opens.

2. On the Utility screen, select the [Osc Ext Add] field and then press the Enter key.

3. When the external addition settings window opens, select an item and then press the ENTER key.

When the selection list for the external addition condition opens, select the desired condition and then press the ENTER key. [x0.4], [x2], and [x10] represent the addition gain.

4. When the external addition setting is completed, select [OK] at the bottom of the window, and then press the ENTER key. The external addition setting change is applied. If you do not want to apply the external addition setting change, select [Cancel] at the bottom of the window and then press the ENTER key, or press the CANCEL key.



c) If the desired external addition condition cannot be selected

■ External addition cannot be ON (set as x0.4, x2, x10)

An external modulation is used.

To use the external addition, change the modulation source to Internal.

The external addition input terminal is being shared with the external modulation input terminal. Therefore, when External is specified as a modulation source for modulated oscillation except FSK and PSK, the external addition cannot be used. The external addition setting at this time always becomes [Off].

Similarly, when an external addition is used, the external modulation cannot be used (excluding FSK and PSK).

■ External addition gain cannot be set as the desired value

The gain of the external addition is determined depending on the output voltage range.

To set the external addition gain by a factor of 0.4, set the amplitude and the DC offset setting so that the output voltage range is 0.8 V.

To set the external addition gain by a factor of 2, set the amplitude and the DC offset setting so that the output voltage range is 4 V.

To set the external addition gain by a factor of 10, set the amplitude and the DC offset setting so that the output voltage range is 20 V.

Since the external addition adds to the final stage of a waveform output (P.1-4), the addition gain is related to the output voltage range. It is fixed to x10 when the maximum output voltage of the range is 20 V, fixed to x2 for 4 V, fixed to x0.4 for 0.8 V, and other addition gains cannot be selected.

Conversely, when the external addition is used, the maximum output voltage of the range is fixed by the addition gain. In particular, note that the fineness of the amplitude accuracy and the waveform may decrease when the amplitude is reduced because it is fixed to 20 V range when the addition gain is x10.

#### 4.4.14 To Set Duty of Square Wave

The waveform is assumed to be set as square wave [Square]. For how to set the waveform, see P.4-18. The setting unit for duty is % only. It cannot be set or displayed with time.

##### a) How to set the duty

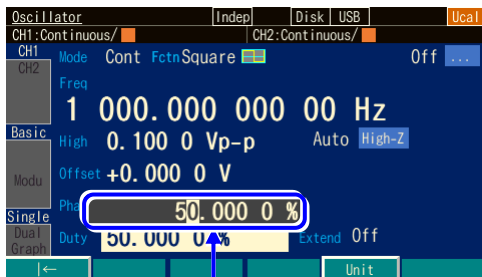

The duty input field is opened.

1. Select the [Duty] field and then press the ENTER key to open the duty input field.
2. Select the digit to be changed with the right or left arrow key, and then use the up or down arrow key or the modify knob to increment or decrement the value. The change is immediately reflected in the output. Or use the numeric keypad to enter the value. Press the ENTER key or the [%] unit key (soft key) to set the input value and reflect it in the output. Even if the ENTER key is used, the output is set as a %.

##### b) How to switch duty variable range

Normally, use the product with this set to Off (standard range).

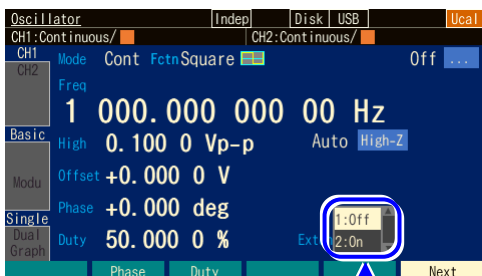

Duty variable range extension selection list

1. Select the [Extend] field and then press the ENTER key to open the duty variable range extension on/off selection list.
2. Select the desired condition from the selection list and then press the ENTER key to set it and reflect it in the output. You can also enter the number of the desired condition displayed in the list from the numeric keypad to set it and reflect it in the output.

This can also be set by entering a number from the numeric keyboard while just the [Extend] field is selected (selection list is not displayed).

c) Difference between standard and enhanced duty variable range

Variable range	Features
Standard	Setting range: 0.0001% to 99.9999% <ul style="list-style-type: none"> <li>• Duty can be changed within the range where jitter is low and the pulse does not disappear.</li> <li>• The setting range of the duty narrows as the frequency rises.</li> <li>• The duty is fixed to approximately 36% to 64% at 30 MHz.</li> </ul>
Enhanced	Setting range: 0.000 0% to 100.000 0% (independent of frequency) <ul style="list-style-type: none"> <li>• There is jitter of 1.3 ns rms or lower typ., and the duty can be always changed from 0% to 100%.</li> <li>• The pulse may sometimes disappear when the pulse width of the high level or the low level is narrower than that of 4.2 ns. However, it becomes equal to the specified duty on average.</li> <li>• When 0% is set, the waveform is fixed to the low level, and when 100% is set, the waveform is fixed to the high level. The pulse is not output in either case.</li> <li>• When the oscillation frequency is an integer ratio relationship with 240 MHz, the edge time will become indeterminate by approximately 4.6 ns. Under other conditions, it will be the specified duty "on average."</li> </ul>

d) Restriction of duty and frequency when duty variable range is standard

The setting range of the duty is limited by the frequency within the following ranges:

$$\text{Frequency (Hz)} \times 115/96\ 000\ 000 \leq \text{duty (\%)} \leq 100 - \text{frequency (Hz)} \times 115/96\ 000\ 000$$

For example, the variable range at 10 MHz is limited to approximately 12.0% to 88.0%.

If the above-mentioned restriction is not satisfied by setting the frequency, the duty is adjusted.

✔ **Check**

When duty variable range extension is on, the frequency may become lower than the setting, because the pulse may disappear depending on the setting. With an application where the frequency needs to be kept constant, use this product with duty variable range extension set to off (standard range).

#### 4.4.15 To Set the Pulse Width, Leading/Trailing Edge Times, and Transition Waveform of the Pulse Wave

The waveform is assumed to be set as pulse wave [Pulse]. For how to set the waveform, see P.4-18.  
 Set the pulse width with time or duty.  
 Set the leading and trailing edge times with time.  
 Set the shape of rising and falling for the transition waveform.

##### a) How To Set Pulse Width time

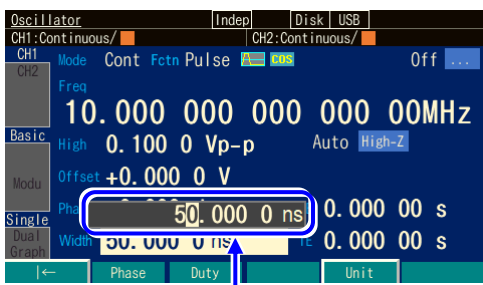

Pulse width time input field

1. Select the [Width] field and then press the ENTER key to open the input field for pulse width.  
 If [Duty] is displayed for the [Width] field because not the pulse width time but pulse width duty is displayed, press the [Width] soft key while the input field of the duty is open. The display switches to pulse width time display.

2. Select the digit to be changed with the right or left arrow key, and then use the up or down arrow key or the modify knob to increment or decrement the value. The change is immediately reflected in the output.  
 Or use the numeric keypad to enter the value. Press the ENTER key or the unit key (soft key) to set the input value and reflect it in the output. When the ENTER key is pressed, "s" is set as the unit.

##### b) How to set pulse width duty

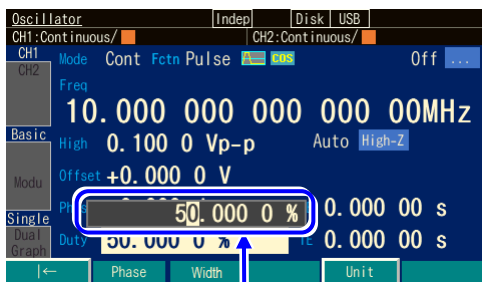

The pulse width duty input field is opened.

1. Select the [Duty] field and then press the ENTER key to open the input field of pulse width duty.  
 If [Width] is displayed for the [Duty] field because not the pulse width time but the pulse width duty is displayed, press the [Duty] soft key while the duty input field is open. The display switches to pulse width duty display.
2. Select the digit to be changed with the right or left arrow key, and then use the up or down arrow key or the modify knob to increment or decrement the value. The change is immediately reflected in the output.

Or use the numeric keypad to enter the value. Press the ENTER key or the unit key (soft key) to set the input value and reflect it in the output. When the ENTER key is pressed, "%" is set as the unit.

**c) To toggle pulse width time and pulse width duty**

○ Pulse width time → Pulse width duty

The input field of pulse width time opens. When the current pulse width time is displayed, the [Duty] soft key is displayed. Press the key to open the input field of pulse width duty, and change the display from [Width] to [Duty]. The [Duty] soft key changes to [Width].

○ Pulse width duty → Pulse width time

The input field of pulse width duty opens. When the current pulse width duty is displayed, the [Width] soft key is displayed. Press the key to open the input field of pulse width time, and change the display from [Duty] to [Width]. The [Width] soft key changes to [Duty].

**d) Difference between pulse width time setting and duty setting**

The following different actions occur depending on whether set the pulse width with time or duty.

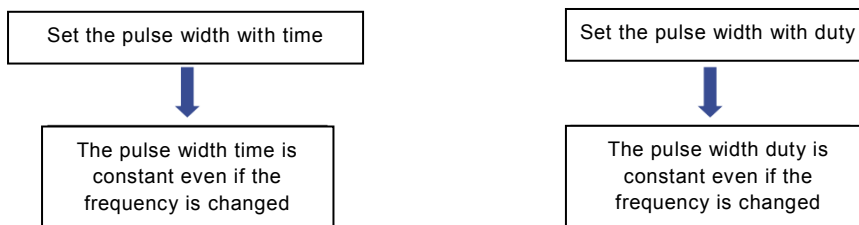

**e) How to set the leading/trailing edge times**

The leading edge [LE] and trailing edge [TE] times can be set with time only.



Leading edge time input field

1. To set the leading edge time, select the [LE] field and then press the ENTER key to open the leading edge input field.  
To set the trailing edge time, select the [TE] field, and then press the ENTER key. The input field of trailing edge time opens.

2. Select the digit to be changed with the right or left arrow key, and then use the up or down arrow key or the modify knob to increment or decrement the value.

The change is immediately reflected in the output.

Or use the numeric keypad to enter the value. Press the ENTER key or the unit key (soft key) to set the input value and reflect it in the output. When the ENTER key is pressed, "s" is set as the unit.

- f) Definitions and limitations of pulse width, leading edge time, trailing edge time, leading edge zone, and trailing edge zone

The definitions of pulse width, leading edge time, trailing edge time, leading edge zone, and trailing edge zone are shown in the following figure.

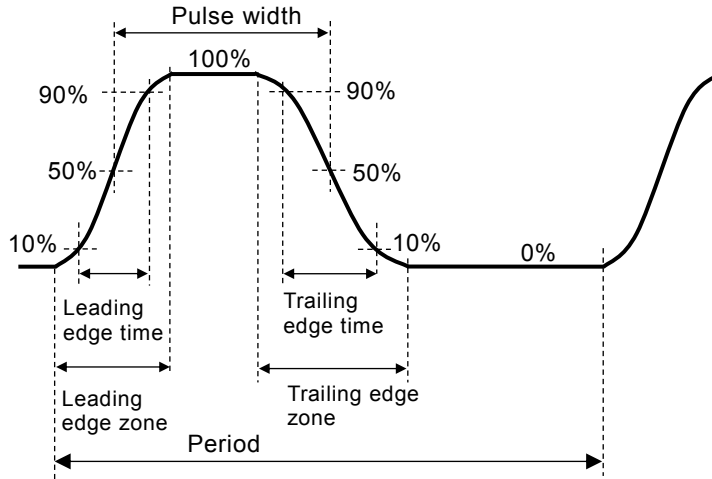

■ Mutual restriction of setting parameters

The setting range is limited mutually as follows for pulse width, leading edge time, trailing edge time, and frequency.

If the following restriction is not satisfied by setting the frequency or the pulse width, the leading and trailing edge times are first adjusted, and then the pulse width is adjusted.

$$\left( \begin{array}{l} \text{Leading edge time} \\ + \text{trailing edge time} \end{array} \right) \times k \leq \text{Pulse width time} \leq \text{Period} - \left( \begin{array}{l} \text{Leading edge time} \\ + \text{trailing edge time} \end{array} \right) \times k$$

However,  $k = \frac{\pi}{4 \arcsin(0.8)} \doteq 0.847$

For example, if the leading and trailing edge times are set to every 100 ns at 1 kHz, the pulse width time can vary between a range of 169.3 ns to 999.83 μs.

■ Setting ranges of leading edge and trailing edge times

The setting values for the leading edge and trailing edge times are subjected to the following restrictions.

(When transition waveform = cosine)	Setting = 7.68 ns to 59.03 Ms
(When transition waveform = other than cosine)	Setting = 11.98 ns to 99.99 9 Ms
The setting resolution is 4 digits or 10 ps.	

For example, the leading and trailing edge times are restricted to 10 ns or longer at 100 Hz.

g) Transition waveform types and setting method

■ Transition waveform types

The following waveforms can be selected for the shapes of the leading-edge zone and trailing edge zone of the pulse waveform.

○ Cosine

This waveform is the same shape as the zone of  $-90^\circ$  to  $+90^\circ$  of a sine wave. The setting range of the leading and trailing edge times is 7.70 ns to 59.03 Ms. The setting values for the leading edge and trailing edge times are applied in any zone with an amplitude of 10% to 90%.

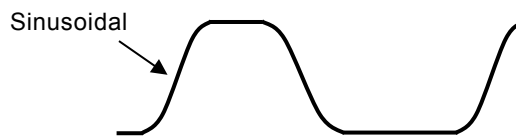

○ Liner

This waveform changes linearly. The setting range of the leading and trailing edge times is 11.98ns to 100.0 Ms.

The setting values for the leading edge and trailing edge times are applied in any zone with an amplitude of 0% to 100%.

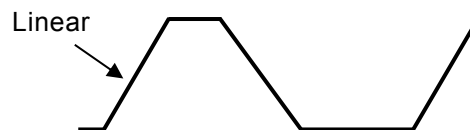

○ PWF

A parameter-variable waveform is used for the leading edge, and a waveform which is that waveform inverted vertically is used for the trailing edge.

The example in the figure below is when a second order LPF step response waveform is selected. In this example, a pulse containing overshoot and ringing can be generated.

The portion from a negative peak to positive peak of the parameter-variable waveform is adjusted automatically so that it will be symmetric along the Y-axis. Therefore, if there is a peak that exceeds the range for the start point and end point of the PWF, the amplitude and offset of that portion may differ from the set values.

The specified amplitude will not be realized if the amplitude range is not  $\pm FS$ .

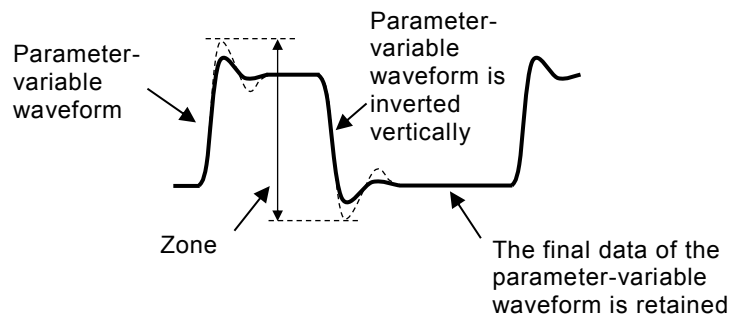

### ○ ARB

The first half of the arbitrary waveform is used as the leading edge, and the second half as the trailing edge.

You can select an arbitrary waveform of array format out of the waveforms in the edit memory or the arbitrary waveform memory of the main unit.

The specified amplitude will not be realized if the amplitude range is not  $\pm FS$ . The vertical axis needs to be symmetric with respect to the origin.

The arbitrary waveform data is abbreviated so that it fits in waveform memory of 4 Ki words.

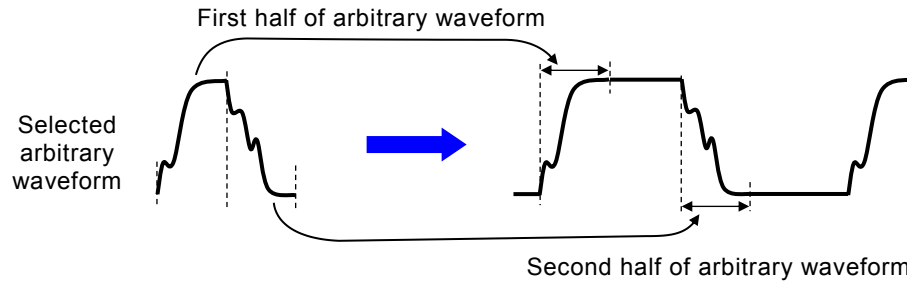

### ✓ Check

To maintain waveform continuity, a waveform with a peak that exceeds the range for the start point and stop point of the arbitrary waveform or parameter-variable waveform may be offset with a peak value of a voltage that differs from the set value.

### ■ Selecting the transition waveform

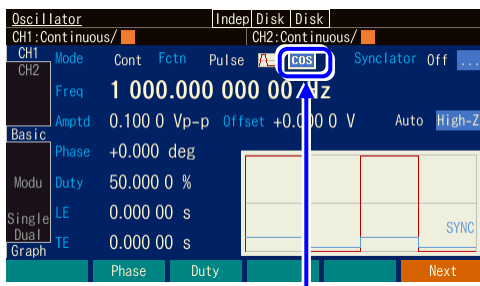

1. Select the edge selection button and then press the ENTER key.

When the waveform is set to pulse, the edge selection button appears.

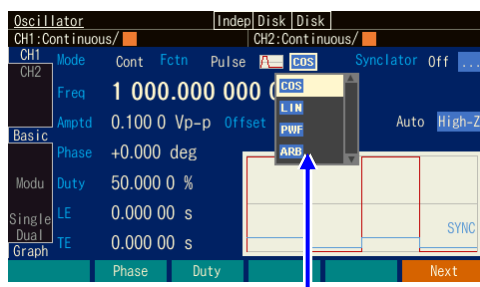

2. When the transition waveform selection list opens, select the desired waveform and then press the ENTER key.

When the transition waveform selection list is opened



#### 4.4.16 To Set Ramp Wave Symmetry

The waveform is assumed to be set to ramp wave [Ramp]. For how to set the waveform, see P.4-18. The unit of symmetry is %. It cannot be set or displayed with time.

##### a) How to set symmetry

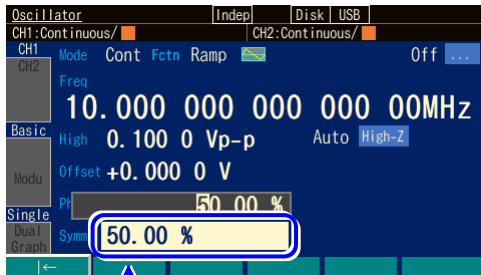

The symmetry input field is opened.

1. Select the [Symm] field and then press the ENTER key to open the input field for symmetry.
2. Select the digit to be changed with the right or left arrow key, and then use the up or down arrow key or the modify knob to increment or decrement the value. The change is immediately reflected in the output. Or use the numeric keypad to enter the value. Press the ENTER key or the unit key (soft key) to set the input value and reflect it in the output. When the ENTER key is pressed, “%” is set as the unit.

##### b) Relationship between symmetry and waveform

A waveform changes as follows depending on the symmetry setting. The symmetry is the total ratio of the rising portion from start to finish. The phase zero degree is fixed to the position in the figure below.

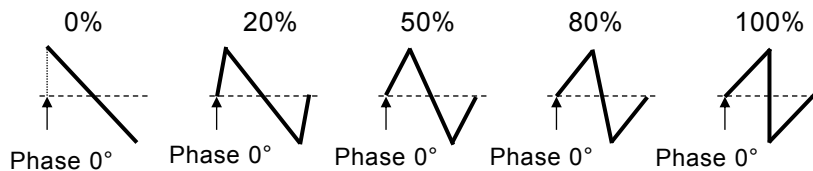

#### 4.4.17 To Set the Equivalent Noise Bandwidth

When the noise waveform is selected, the [BW] item will appear to set the equivalent noise bandwidth. The equivalent noise bandwidth can be set to seven different levels.

Select the optimal equivalent bandwidth so that the noise voltage in the bandwidth will be sufficiently large because the wider the equivalent bandwidth, the more the amplitude density of the noise will decrease, even if the same output amplitude is set.

The equivalent bandwidth refers to the value obtained when the noise power is the same as the ideal filter. The frequency characteristics of the cutoff area differ for each setting because this instrument uses a simple filter.

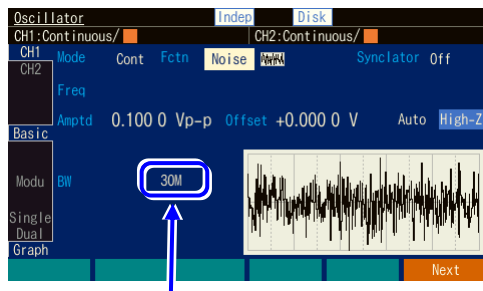

Set the equivalent bandwidth so that the bandwidth and amplitude density of the noise become optimal.

#### 4.4.18 To Set the Setting Range Limit Values

The setting range for the setting values of the signals to be output from the waveform output can be limited. The parameters that can be limited are frequency, voltage, phase, and duty.

With respect to voltage, the setting range limit values apply to the positive and negative peak values of the waveform amplitude and DC offset combined.

These limit values are initialized by a reset. [P.16-2](#)

The settings of the setting range limits can be configured in the Utility screen.

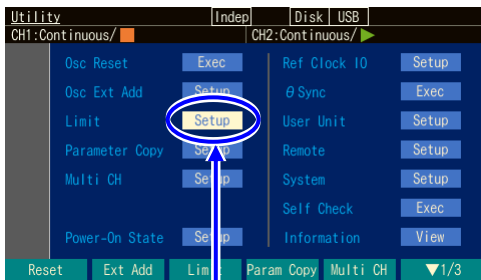

In the Utility screen, select [Limit] and press the ENTER key.

1. In the Utility screen, select [Limit] and then press the ENTER key.

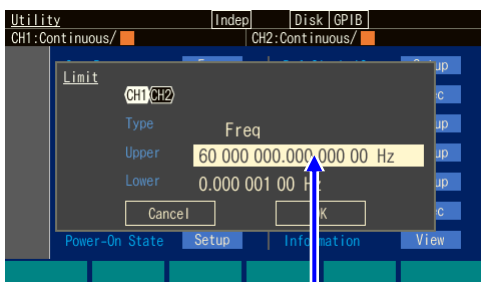

In the Utility screen, select [Upper] and press the ENTER key.

2. The figure on the left is the case of the upper limit of frequency. Select Upper of Freq and then press the ENTER key to open the input field of the frequency upper limit value.

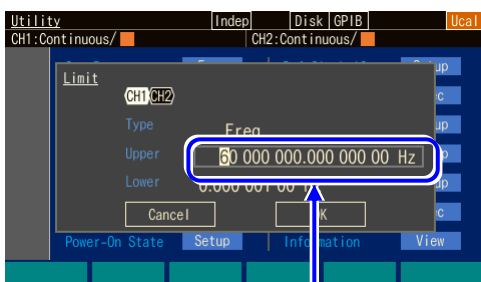

The upper limit setting input field is opened

3. Select the digit to be changed with the right or left arrow key, and then use the up or down arrow key or the modify knob to increment or decrement the value. The change is immediately reflected to the output. Or use the numeric keypad to enter the value. Press the ENTER key or the unit key (soft key) ([μHz], [mHz], [Hz], [kHz] [MHz]) to set the input value.

#### Check

This setting is invalid for the input signal of external addition. Be careful because a voltage and frequency exceeding the limit values may be output depending on the size of the input signal.

### 4.4.19 To Select Sub Output

A signal output from the synchronization/sub output terminal is called sub output.

It can be selected in the sub output selection [SubOut] setting on page 4 of the Oscillator setting screen.

Although the selection options differ depending on factors such as the oscillation mode, the following selection options are available for the continuous oscillation mode. For the selection options in other than the continuous oscillation mode, see each of the oscillation modes.

■ **Waveform reference phase synchronization [Sync]**

Outputs the reference phase synchronization signal of the waveform output (50% duty square wave which rises at the 0° point of the reference phase for the waveform output).

■ **Sub-waveform reference phase synchronization [SubSync]**

Outputs the reference phase synchronization signal of the sub waveform (50% duty square wave which rises at the 0° point of the reference phase for the sub waveform).

■ **Sub waveform [SubFctn]**

Outputs a waveform with a frequency and amplitude which differ from those of the waveform output.  P.4-128

■ **Off [Off]**

Output will be a direct current of about 0 V.

This helps to reduce interference from a ground common with externally connected devices or from a synchronization output signal.

The output impedance changes to about 100 Ω at this time.

## 4.5 Using Parameter-Variable Waveforms

For details on variable parameter waveforms, see P. 6-2

- a) To output a parameter-variable waveform (PWF)



Waveform input field

Press the FCTN shortcut key.

Press the key ([5] key) corresponding to the PWF. Or, select the [Fctn] field and then press the ENTER key to open the selection list.

Similar to other waveforms, the waveform's polarity and amplitude range may also be changed.

- b) To change the waveform of a parameter-variable waveform

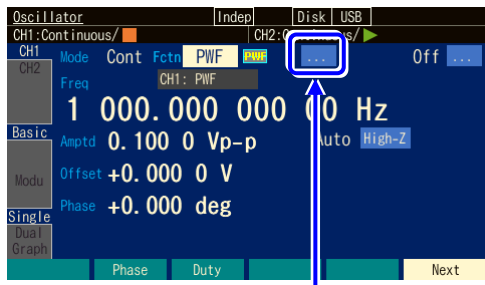

Selection button for selecting a parameter-variable waveform

1. The [...] button is displayed on the right of the polarity/amplitude range icon when the waveform is set to parameter-variable waveform [PWF].

Pressing this button displays the name of the currently selected PWF.

Press the ENTER key to display the PWF's selection screen.

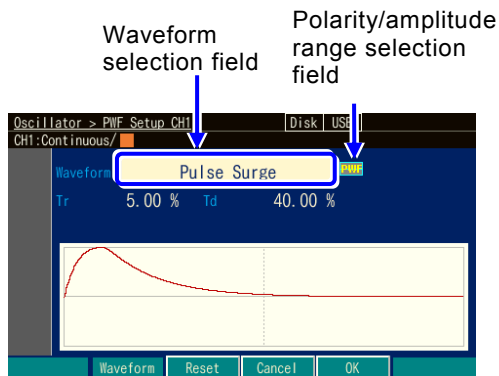

2. Configure the parameter-variable waveform and individual parameter settings on the variable parameter waveform selection screen. Set the desired waveform in the [Waveform] field. Set the polarity and amplitude ranges with the polarity/amplitude range icon. The settings are independent for each waveform. These settings can be changed even if you leave the selection screen.

Each waveform has a maximum of 6 specific variable parameters to be set.

Press the [Reset] soft key to initialize the variable parameters. The changes are immediately reflected in the output waveform. The shape of the set waveform is displayed on the graph.

3. Press the [OK] soft key to confirm the changes and exit the selection screen.  
Press the [Cancel] soft key to discard the changes and exit the selection screen.  
Press the basic parameter shortcut key to confirm the changes and exit the selection screen.
  
4. Press the [OK] soft key to confirm the changes and exit the selection screen .

✔ **Check**

The AC component of the waveform may disappear depending on the parameter settings.

Press the [Reset] soft key if it is unclear how to restore the settings. This returns each parameter to the default factory setting. The polarity and amplitude range are not changed.

## 4.6 Using Arbitrary Waveforms

For how to create an arbitrary waveform, see P.7-2.

To output an arbitrary waveform saved in USB flash memory, it must first be copied to the edit memory or internal memory. For the recall method, see P. 7-12

### a) To output an arbitrary waveform (ARB)

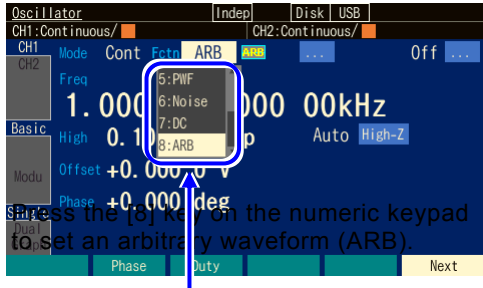

Press the FCTN shortcut key and then press the key ([F] key) corresponding to the arbitrary waveform (ARB).

Similar to other waveforms, the waveform's polarity and amplitude range may also be changed.

### b) To change the waveform of an arbitrary waveform

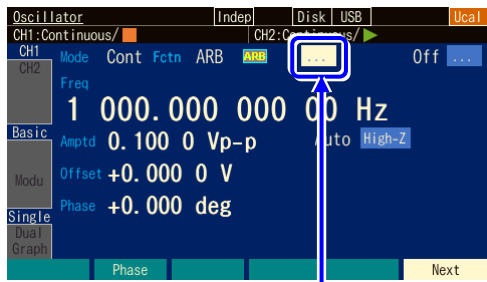

1. [...] is displayed on the right side of the amplitude setting range icon when the waveform is set to an arbitrary waveform [ARB]. Select this and then press the [ENTER] key to go to the arbitrary waveform selection screen.

When [...] is selected, the selected arbitrary waveform is displayed directly beneath the field

2. The arbitrary waveform can be selected on the arbitrary waveform selection screen. If the waveform number is set in the arbitrary waveform number field, an outline of the waveform is displayed on the graph screen.

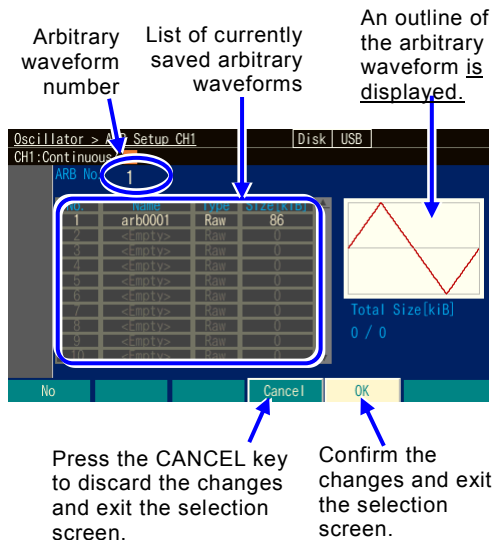

3. Press the [OK] soft key to confirm the changes and exit the selection screen. Press the [Cancel] soft key to discard the changes and exit the selection screen. Press the basic parameter shortcut key to discard the changes and exit the selection screen.

The changes will not be reflected in the output waveform until the [OK] soft key is pressed.

Arbitrary waveforms cannot be created on this screen. For details on creation of an arbitrary waveform or the data format and memory capacity, see P. 7-2.

### c) To use the arbitrary waveform data of our previous model

## 4.6 Using Arbitrary Waveforms

---

The previous model uses long arbitrary waveform data. This method thinned out and duplicated the data depending on the set frequency so that the average frequency matched the set frequency. In contrast, this product outputs all waveform data for each sampling frequency. Therefore, the maximum frequency that can be output is limited to  $240 \text{ MHz} \div \text{number of data}$ .

To reuse the data of the previous model, process the waveform data so that the output frequency of an arbitrary waveform becomes lower than this limit.



## 4.7 Setting and Operation of Modulation

### 4.7.1 Modulation Function

Modulation can be performed with respect to setting values that do not generate a conflict in, of course, continuous oscillation mode but also while performing burst oscillation or sweep oscillation.

With this product, the oscillation mode is called a modulation function to make it clear that it means an independent function.

If modulation is used in combination when burst or gated sweep mode, modulation is also applied to the stop period.

### 4.7.2 Modulation Types

The following eight types of modulations are available.

- FM: Frequency Modulation ☞ P.4-70
  
- FSK: Frequency Shift Keying  
Binary Frequency Shift Keying. ☞ P.4-71
  
- PM: Phase Modulation ☞ P.4-72
  
- PSK: Phase Shift Keying  
Binary Phase Shift Keying. ☞ P.4-73
  
- AM: Amplitude Modulation  
This is amplitude modulation with the carrier frequency component. ☞ P.4-74
  
- AM(DSB-SC): Amplitude Modulation (Double Side Band - Suppressed Carrier)  
AM without carrier frequency element. ☞ P.4-75
  
- DC Offset Modulation: Offset Modulation ☞ P.4-77
  
- PWM: Pulse Width Modulation ☞ P.4-78

4.7.3 Screen for Setting and Operation of Modulation

The following explains the common screen configuration of the modulation function.

Perform configuration and operation in the Oscillator setting screen. When you press the MENU key while another screen is displayed, the Top menu is displayed. Select [Settings] and then press the ENTER key.

a) Page 1 of the setting screen: screen for setting the carrier signal

These are common items which are independent of the oscillation mode. This is the screen for setting the modulation carrier signal. For the setting procedure, see “4.4 Setting for Main Items..”

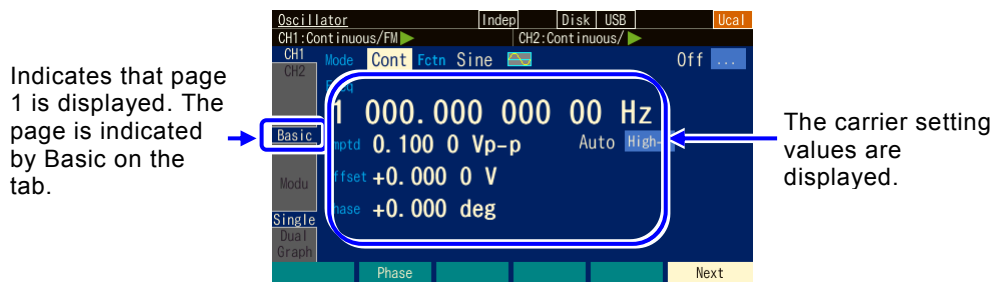

b) Page 4 of the setting screen: Screen for setting the modulation function and synchronization/sub output terminal

This appears on page 4 also in the sweep oscillation mode and burst oscillation mode.

The following figure is an example of selecting FM as a modulation type.

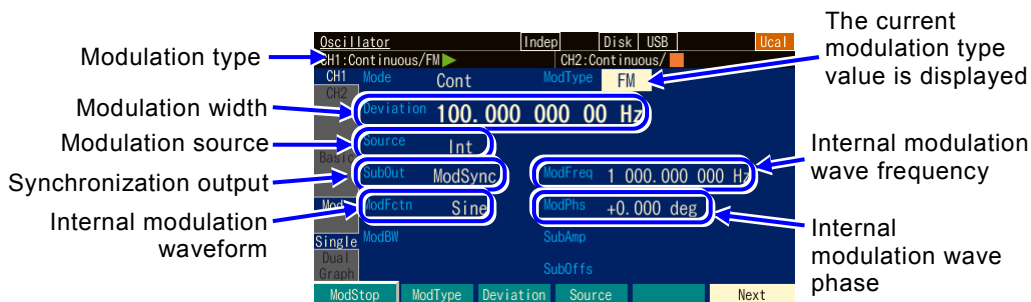

1) Modulation type [ModType]

These are the types of modulation. Select from FM, FSK, PM, PSK, AM, AM (DSB-SC), DC offset modulation, and PWM. P.4-66

FSK and PSK cannot be selected in a burst mode other than auto burst and in sweep oscillation mode.

If you select Off (modulation function is not used), a signal without modulation is output.

2) Modulation width [Deviation, Depth, HopFreq]

The item name changes with the modulation type. P.4-66

The modulation signal will have no effect on the waveform output when the modulation width is set to 0.

Setting the modulation source to internal [Int] and the sub output selection [SubOut] to internal modulation waveform [ModFctn] will output an internal modulation signal from the synchronization/sub output BNC terminal.

When the modulation width is 0, the internal modulation signal can be used as an independent signal source by freely setting its waveform, frequency, phase, amplitude, and DC offset.

### 3) Modulation source [Source]

Select internal [Int] or external [Ext] for the modulation source. [P.4-67](#)

When it is FSK and PSK, internal [Int], external [Ext], external 1 [Ext1], or external 2 [Ext2] can be selected.

Internal cannot be selected in sweep oscillation mode.

### 4) Internal modulation frequency [ModFreq]

This is the frequency of the internal modulation source. [P.4-67](#)

This item is not available when the modulation function is off or set to external modulation.

### 5) Internal modulation waveform [ModFctn]/Sub waveform [SubFctn]

Sets the waveform for the internal modulation source when the modulation function is turned on and set to internal modulation. Select from sine wave, square wave, triangle wave, rising ramp wave, falling ramp wave, noise, arbitrary waveform, and parameter-variable waveform.

[P.4-67](#)

You can select the sub waveform that can be output to the sub output when the modulation function is turned off or not set to internal modulation.

### 6) Internal modulation phase [ModPhs]/Sub waveform phase [SubPhs]

This is the phase of the internal modulation source when the modulation function is turned on and set to internal modulation. Change the phase difference between the reference phase of the internal modulation source and the waveform output.

Set the sub waveform phase output to the sub output when the modulation function is turned off or set to external modulation.

[P.4-67](#)

### 7) Sub output selection [SubOut]

Selects the output signal from the synchronization/sub output terminal. Choose from the selection list. [P.4-68](#)

### 8) Sub output amplitude [SubAmp]

Sets the output amplitude for when the internal modulation waveform and sub waveform are output from the synchronization/sub output terminal. [P.4-128](#)

### 9) Sub output offset [SubOfs]

Sets the output offset for when the internal modulation waveform and sub waveform are output from the synchronization/sub output terminal. [P.4-129](#)

### 4.7.4 Common Settings and Operation of Modulation

The following explains the common settings and operation independent of the modulation type.

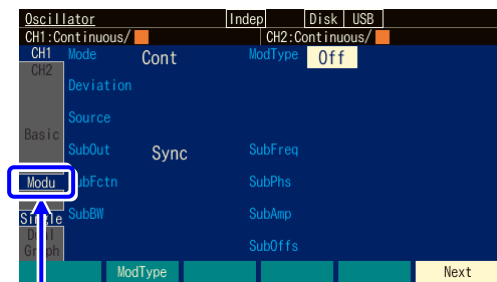

Switch to the state with the page 4 (Modu) selected

1. Press the Next soft key multiple times to display page 4 of the setting screen ([Modu] in the tab area becomes selected). Or, turn the modify knob to select “Modu” in the tab area and then press the ENTER key.

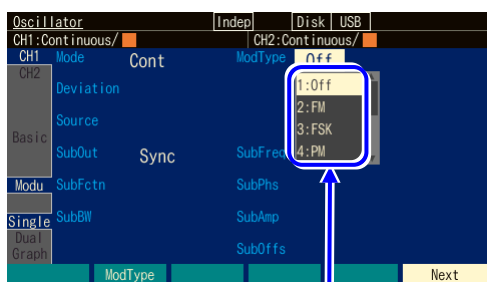

The modulation type selection list is opened. Select the desired modulation type

2. Select the [ModType] field in the setting area and then press the ENTER key to open the modulation type selection list.
3. Select a desired modulation type other than Off and then press the ENTER key. Modulation is now possible.

**a) To select the type of modulation**

Select from the following eight types in the modulation types [ModType] on page 4 of the setting screen.

- FM [FM] ⓘ P.4-70
- FSK [FSK] ⓘ P.4-71
- PM [PM] ⓘ P.4-72
- PSK [PSK] ⓘ P.4-73
- AM [AM] ⓘ P.4-74
- AM (DSB-SC) [AM(SC)] ⓘ P.4-75
- DC Offset Modulation [OFSM] ⓘ P. 4-77
- PWM [PWM] ⓘ P.4-78

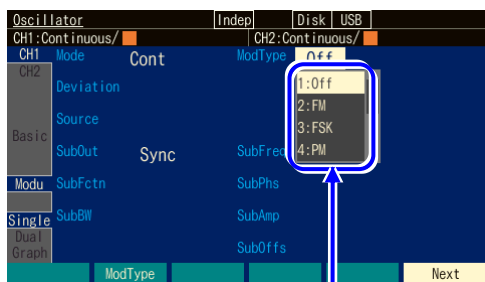

Modulation type

**b) To set the carrier condition**

Set each parameter of the carrier signals on page 1 of the setting screen. ⓘ P.4-32

**c) To set the modulation width**

Set this in the modulation width setting item on page 4 of the setting screen. The displayed item name will be any of [Deviation], [Depth], or [HopFreq] depending on the modulation type.

For details, see the description of each modulation type.

**d) To modulate with internal signal source**

Set the modulation source [Source] to internal [Int] on page 4 of the setting screen.

The internal modulation waveform [ModFctn], internal modulation frequency [ModFreq], and internal modulation phase [ModPhs] must be set.

Select the internal modulation waveform [ModFctn] from the following eight types:

- Sine wave [Sine]
- Square wave (50% duty) [Square]
- Triangle wave (symmetry 50%) [Triangle]
- Up ramp wave [UpRamp]
- Down ramp wave [DnRamp]
- Noise [Noise]
- Arbitrary waveform [ARB]
- Parameter-variable waveform [PWF]

If the internal modulation waveform is noise, the internal modulation frequency cannot be set. When the modulation type is FSK or PSK, the internal modulation waveform is fixed to a square wave with 50% duty, and the internal modulation waveform cannot be selected.

When an arbitrary waveform is selected as the internal modulation waveform, arbitrary waveforms in an array format use converted data comprising a total of 4 096 points. The arbitrary waveforms where [RAW] is displayed in the [Type] field of the selection screen of arbitrary waveforms are in array format. On the other hand, the arbitrary waveforms where [Point] is displayed in the [Type] field are in control point format. In arbitrary waveforms in this format, the entire waveform is developed with 4 096 points so that the features of the waveform may remain as much as possible. For details on arbitrary waveforms, see P.7-2.

If you change the value of the internal modulation phase [ModPhs], the phase of the modulation signal changes. The reference of the phase is common with 2-channel equipment.

**e) To modulate with external signal source**

Set the modulation source [Source] to external [Ext], external 1 [Ext1] or external 2 [Ext2] on page 4 of the setting screen.

The input terminal of the external modulation signal is different according to the modulation type as follows:

■ **Modulation type is FM, PM, AM, AM(SC), OSFM, or PWM**

Input a modulation signal to the external modulation/addition input terminal. The setting of the modulation width is the value for a signal level of  $\pm 1V$ . Note that if the input level is lower than  $\pm 1V$ , the modulation width is lower than the specified value.

When the external modulation/addition input terminal is used for the external addition input, the external modulation function cannot be used.

■ **Modulation type is FSK or PSK**

Input a modulating signal (TTL level) to the external trigger input terminal.

The polarity can be set on the screen.

- f) To start modulation → Modulation starts automatically. Resume modulation with the [ModStart] soft key

When the modulation function is set to on, modulated oscillation starts automatically.

However, the modulated oscillation will not start if the modulation setting is inappropriate ([Conflict] will be displayed in the channel status area). When the [?] soft key displayed on the left end is pressed, a message about the inappropriate setting will be displayed. P.14-8

When the setting is changed to an appropriate setting, modulated oscillation starts.

If modulation is paused, press the [ModStart] soft key to resume modulation.

- g) To stop modulation

Modulation can be paused.

When the [ModStop] soft key is pressed during modulation, the modulation will stop and the carrier signal is output without being modulated. To resume modulation, press [ModStart].

- h) To select the signal output from the synchronization/sub-output BNC terminal → Select the sub output

Set this in sub output selection [SubOut] on page 4 of the setting screen. The selection options vary depending on factors such as the oscillation mode. Select an option from following table.

Internal modulation	External modulation
Waveform reference phase synchronization [Sync]	Waveform reference phase synchronization [Sync]
Internal modulation synchronization [ModSync]	-
Internal modulation waveform [ModFctn]**	Sub waveform [SubFctn]
Off [Off]	Off [Off]

\*\* : This cannot be selected when FSK or PSK.

- When [Sync] is selected

A signal with TTL level which rises at the reference phase of the waveform is output from the synchronization/sub-output terminal.

- When [ModSync] is selected,

A signal with TTL level which is synchronized with the internal modulation waveform is output from the synchronization/sub-output terminal. A square wave with 50% duty rising at the zero phase of the internal modulation waveform. When the internal modulation waveform is a noise, it is fixed to the low level.

When a signal under modulation is observed with an oscilloscope or similar device, it can be used as a trigger signal of the oscilloscope.

- When [ModFctn] is selected (only when modulation function is on and using internal modulation)

The internal modulation waveform is output from the synchronization/sub-output BNC terminal. The amplitude can be set in sub output amplitude [SubAmp], and the DC offset in sub output offset [SubOfs]. The signal level is a maximum of  $\pm 3.3$  V/open.

- When [SubFctn] is selected

The sub waveform is output. The waveform, amplitude, offset, and phase are settable independently from waveform output. For the setting procedure, [P.4-128](#).

- When [Off] is selected

The output will be approximately 0 V. This helps to reduce interference from a ground common with externally connected devices or from a synchronization output signal.

- When [BrstSync], [SwpSync], and [SwpSync+Mkr] are selected

Burst oscillation mode [P.4-103](#), Sweep oscillation mode [P.4-80](#).

### 4.7.5 Setting FM

The output frequency varies according to the instantaneous value of the modulation signal.

For details on the modulation setting screen and common operation method, see P.4-64 and P.4-66.

#### a) Example of FM

When the modulating signal swings to the positive side, the frequency of the output signal increases.

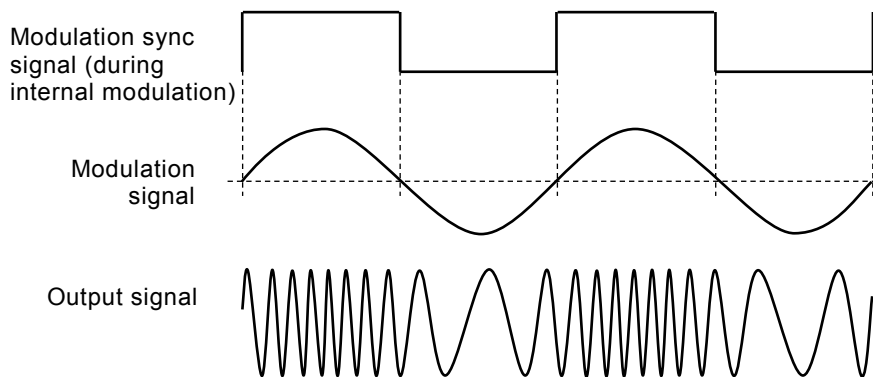

#### b) To select FM

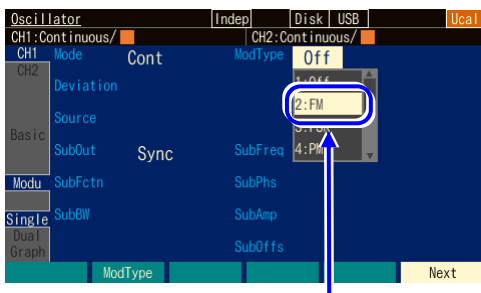

Set the modulation type [ModType] to FM [FM] on page 4 of the setting screen.

Select [FM] in the modulation type setting menu

#### c) Waveform or mode where FM is unavailable

FM cannot be performed for noise, pulse, and DC.

FM cannot be used when frequency sweep.

#### d) Setting items necessary for FM

Set the carrier frequency [Freq] on page 1 of the setting screen.

Set the peak frequency deviation [Deviation] on page 4 of the setting screen.

The output frequency varies within the range of carrier frequency  $\pm$  peak frequency deviation.

When the modulation source [Source] is internal [Int], set the modulation waveform [ModFctn], modulation frequency [ModFreq], and modulation phase [ModPhs]. Internal [Int] cannot be selected during sweep oscillation mode.

When the modulation source [Source] is external [Ext]/[Ext1]/[Ex2], input the modulating signal to the external modulation/addition input terminal. It reaches the specified peak frequency deviation at  $\pm 1$  V input.



### 4.7.6 Setting FSK

A binary frequency deviation modulation with which the output frequency is switched between the carrier frequency and hop frequency according to the modulating signal.

For details on the modulation setting screen and common operation method, see P.4-64, P.4-66.

#### a) Example of FSK

The frequency changes abruptly, but the phase continuity of the output signal is maintained.

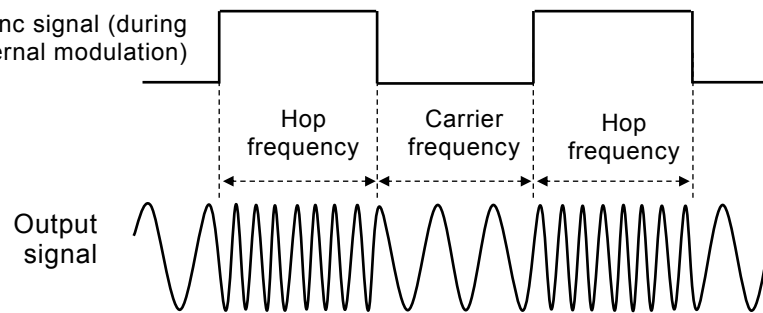

#### b) To select FSK

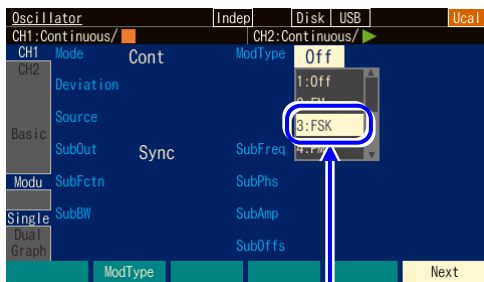

Select [FSK] in the modulation type setting menu

Set the modulation type [ModType] to FSK [FSK] on page 2 of the setting screen.

#### c) Waveform or mode where FSK is unavailable

FSK cannot be performed for noise, pulse wave, and DC.

In burst oscillation mode, FSK cannot be performed when other than auto burst.

In sweep oscillation mode, FSK cannot be performed when frequency sweep and internal FM.

#### d) Setting items necessary for FSK

Set the carrier frequency [Freq] on page 1 of the setting screen.

Set the hop frequency [HopFreq] on page 4 of the setting screen.

The output frequency is switched alternately between carrier frequency and hop frequency.

When the modulation source [Source] is internal [Int], set the modulation frequency [ModFctn] and modulation phase [ModPhs]. Internal [Int] cannot be selected during sweep oscillation mode.

Set the polarity of the trigger when the modulation source [Source] is external [Ext]/[Ext1]/[Ext2], and then input a modulation signal (TTL level) to the external trigger input terminal. When the polarity is set as positive [High], the carrier frequency is output for low-

level input, and the hop frequency is output for high-level input. When the polarity is set as negative [Low], that is reversed.

The internal modulation source setting is common to the burst internal trigger and sweep internal trigger settings.

### 4.7.7 Setting PM

The output phase varies according to the instantaneous value of the modulation signal.

For details on the modulation setting screen and common operation method, see P.4-64 and P.4-66.

#### a) Example of PM

When the modulating signal swings to the positive side, the phase shift of the output signal increases at the positive side.

The instantaneous frequency also changes at the same time because the phase changes with time.

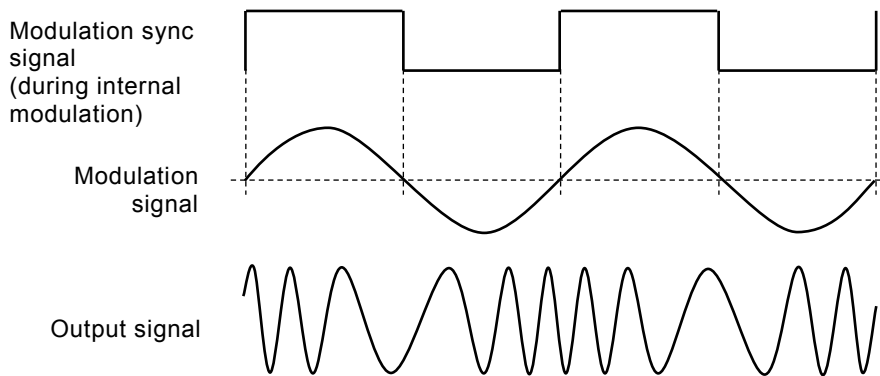

#### b) To select PM

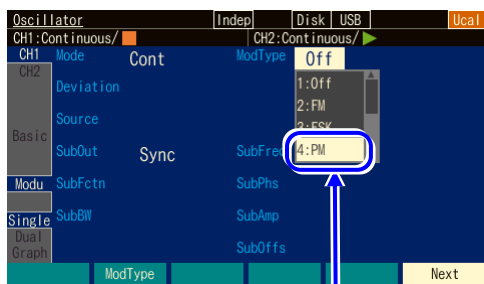

Select [PM] in the modulation type setting menu

Set the modulation type [ModType] to PM [PM] on page 2 of the setting screen.

#### c) Waveform or mode where PM is unavailable

PM cannot be performed for an arbitrary waveform, parameter-variable waveform, noise, and DC.

PM cannot be performed when phase sweep.

**d) Setting items necessary for PM**

Set the peak phase deviation [Deviation] on page 4 of the setting screen.

The output phase varies within the range of  $\pm$  peak phase deviation.

When the modulation source [Source] is internal [Int], set the modulation waveform [ModFctn], modulation frequency [ModFreq], and modulation phase [ModPhs]. Internal [Int] cannot be selected during sweep oscillation mode.

When the modulation source [Source] is external [Ext]/[Ext1]/[Ext2], input a modulating signal to the external modulation/addition input terminal. It reaches the specified peak phase deviation at  $\pm 1$  V input.

**4.7.8 Setting PSK**

A binary frequency deviation modulation with which the output phase is offset according to the modulation signal.

For details on the modulation setting screen and common operation method, see P.4-64, P.4-66.

**a) Example of PSK**

The output signal waveform is discontinuous because the phase changes abruptly.

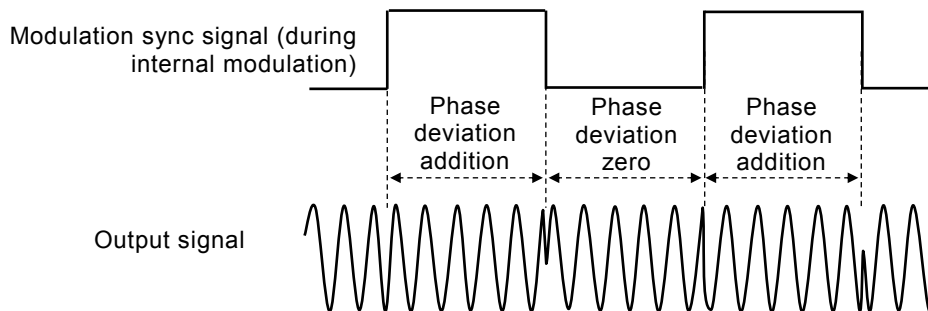

**b) To select PSK**

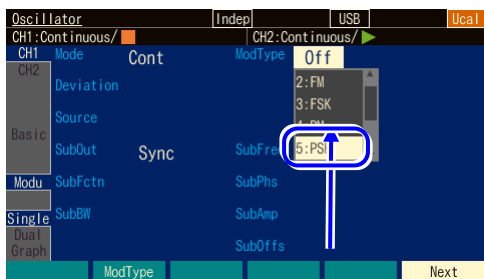

Select [PSK] in the modulation type setting menu

Set the modulation type [ModType] to PSK [PSK] on page 2 of the setting screen.

**c) Waveform or mode where PSK is unavailable**

PSK cannot be performed for an arbitrary waveform, parameter-variable waveform, noise, and DC.

In burst oscillation mode, PSK cannot be performed when other than auto burst.

In sweep oscillation mode, PSK cannot be performed when phase sweep and internal PM.

### d) Setting items necessary for PSK

Set the phase deviation [Deviation] on page 4 of the setting screen.

The phase deviation zero state and specified phase deviation state alternate for the output.

Note that the phase does not change within the range of  $\pm$  phase deviation.

When the modulation source [Source] is internal [Int], set the modulation frequency [ModFctn] and modulation phase [ModPhs]. Internal [Int] cannot be selected during sweep oscillation mode.

Set the polarity of the trigger when the modulation source [Source] is external [Ext]/[Ext1]/[Ext2], and then input a modulation signal (TTL level) to the external trigger input terminal. When the polarity is set as positive [High], the phase deviation of zero is output for low-level input, and the specified phase deviation is output for high-level input. When the polarity is set as negative [Low], that is reversed.

### 4.7.9 Setting AM

The output amplitude varies according to the instantaneous value of modulation signal.

For details on the modulation setting screen and common operation method, see P.4-64 and P.4-66.

#### a) Example of AM

When the modulating signal swings to the positive side, the amplitude of the output signal increases.

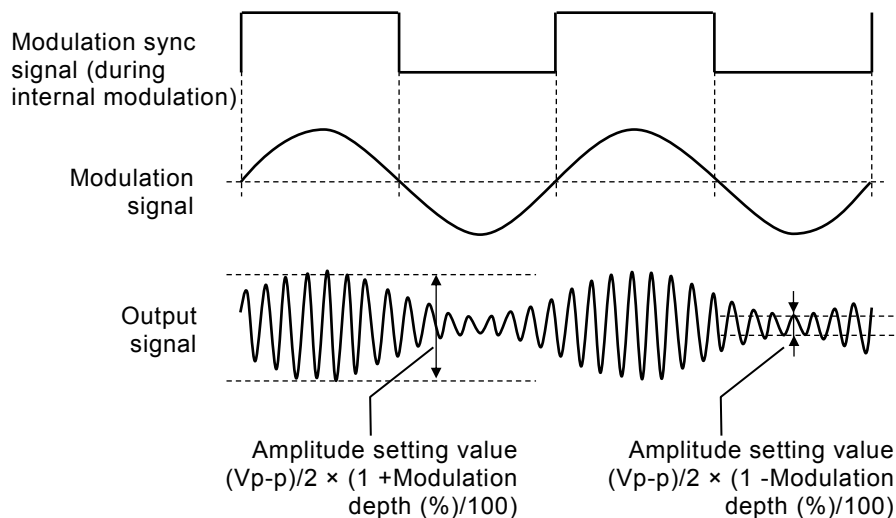

b) To select AM

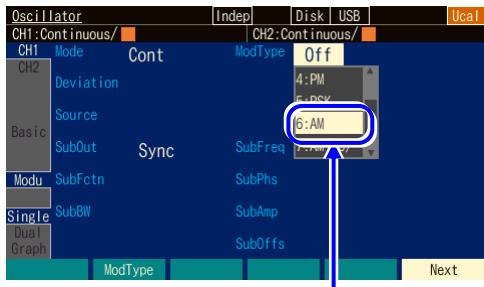

Select [AM] in the modulation type setting menu

Set the modulation type [ModType] to AM [AM] on page 2 of the setting screen.

c) Waveform where AM is unavailable

AM cannot be performed for DC.  
AM cannot be performed when amplitude sweep.

d) Setting items necessary for AM

Set the carrier amplitude [Amptd] on page 1 of the setting screen.  
Set the modulation depth [Depth] on page 4 of the setting screen.  
The output amplitude varies within the range of the carrier amplitude setting value  $(V_{p-p}) / 2 \times (1 \pm \text{modulation depth} / 100)$ .  
The modulation depth is a value displayed as a %. For example, when the modulation depth is 0% or the modulation is stopped, the output amplitude is half of that in the continuous oscillation mode.  
When the modulation depth is 100%, the maximum value of the output amplitude envelope is equal to the carrier amplitude setting value.  
When the modulation source [Source] is internal [Int], set the modulation waveform [ModFctn], modulation frequency [ModFreq], and modulation phase [ModPhs]. Internal [Int] cannot be selected during sweep oscillation mode.  
When the modulation source [Source] is external [Ext]/[Ext1]/[Ext2], input a modulating signal to the external modulation/addition input terminal.  
It is at the specified modulation depth when  $\pm 1$  V is input.

4.7.10 Setting AM (DSB-SC)

The output amplitude varies according to the instantaneous value of the modulation signal. This is AM without the carrier frequency component.  
DSB-SC is an abbreviation of Double Side Band - Suppressed Carrier.  
For details on the modulation setting screen and common operation method, see P.4-64 and P.4-66.

a) AM (DSB-SC) example

The amplitude of the output signal increases when the absolute value of the amplitude of modulation signal is large. The polarity of the output signal reverses when the modulation signal is negative.

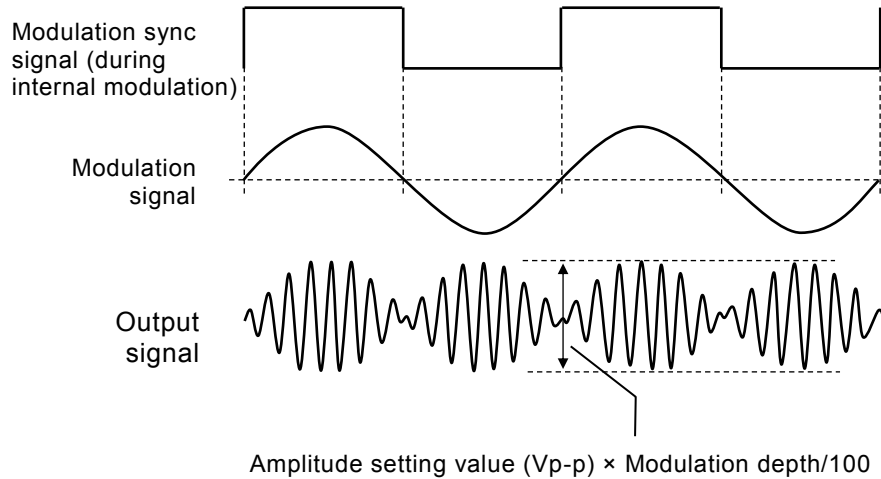

b) To select AM (DSB-SC)

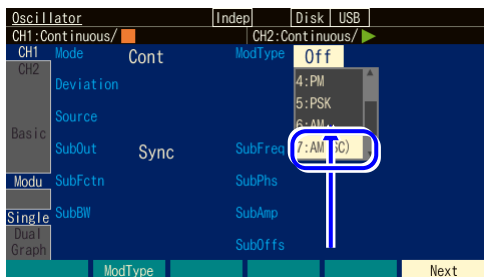

Set the modulation type [ModType] to AM (DSB-SC) [AM(SC)] on page 2 of the setting screen.

Select [AM(SC)] in the modulation type setting menu

c) Waveform where AM (DSB-SC) is unavailable

AM (DSB-SC) cannot be performed for DC.

AM (DSB-SC) cannot be performed when amplitude sweep.

d) Setting items necessary for AM (DSB-SC)

Set the carrier amplitude [Amptd] on page 1 of the setting screen.

Set the modulation depth [Depth] on page 4 of the setting screen.

The output amplitude varies within the range of carrier amplitude setting value (Vp-p) × modulation depth/100.

The modulation depth is a value displayed as a %. For example, when the modulation depth is 100%, the maximum value of the output amplitude envelope is equal to the carrier amplitude setting value.

When the modulation source [Source] is internal [Int], set the modulation waveform [ModFctn], modulation frequency [ModFreq], and modulation phase [ModPhs]. Internal [Int]

cannot be selected during sweep oscillation mode.

When the modulation source [Source] is external [Ext]/[Ext1]/[Ext2], input a modulating signal to the external modulation/addition input terminal. It is at the specified modulation depth when  $\pm 1$  V is input.

### 4.7.11 Setting DC Offset Modulation

The DC offset varies according to the instantaneous value of the modulation signal.

For details on the modulation setting screen and common operation method, see P.4-64 and P.4-66.

#### a) Example of DC offset modulation

When the modulating signal swings to the positive side, the DC offset of the output signal increases in the positive direction.

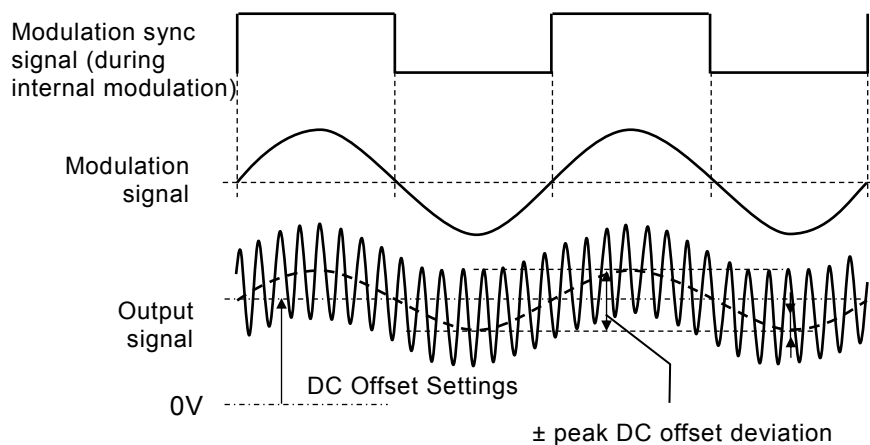

#### b) To select DC offset modulation

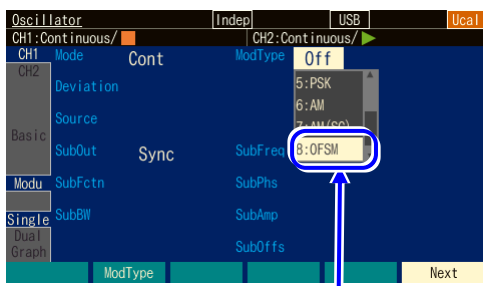

Select [OFSM] in the modulation type setting menu

Set the modulation type [ModType] to DC offset modulation [OFSM] on page 2 of the setting screen.

#### c) Waveform or mode where DC offset modulation is unavailable

There are no waveforms where DC offset modulation is unavailable. All waveforms are included.

DC offset modulation cannot be performed when DC offset sweep.

#### d) Setting items necessary for DC offset modulation

Set the DC offset [Offset] on page 1 of the setting screen.

Set the peak DC offset deviation [Deviation] on page 4 of the setting screen.

The output DC offset varies within the range of DC offset setting  $\pm$  peak DC offset deviation.

When the modulation source [Source] is internal [Int], set the modulation waveform [ModFctn], modulation frequency [ModFreq], and modulation phase [ModPhs]. Internal [Int] cannot be selected during sweep oscillation mode.

When the modulation source [Source] is external [Ext]/[Ext1]/[Ext2], input a modulating signal to the external modulation/addition input terminal. It reaches the specified peak DC offset deviation at  $\pm$  1 V input.

### 4.7.12 Setting PWM

The duty of the square wave and pulse wave varies according to the instantaneous value of the modulation signal. However, the duty actually changes from the next cycle so that the cycle of the output signal does not become other than the set value.

For details on the modulation setting screen and common operation method, see P.4-64 and P.4-66.

#### a) Example of PWM

When the modulating signal swings to the positive side, the duty of the output signal increases.

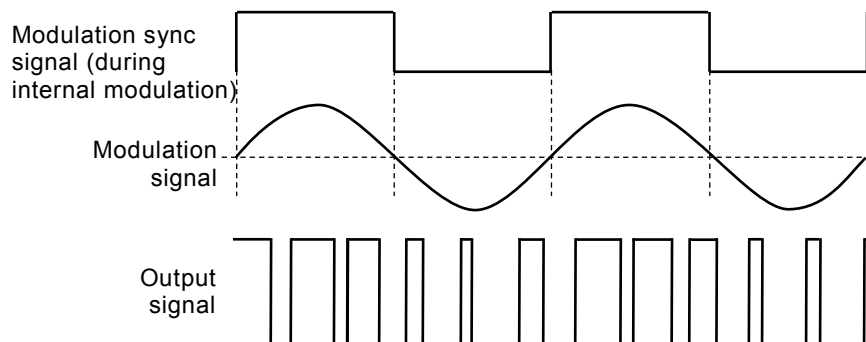

#### b) To select PWM

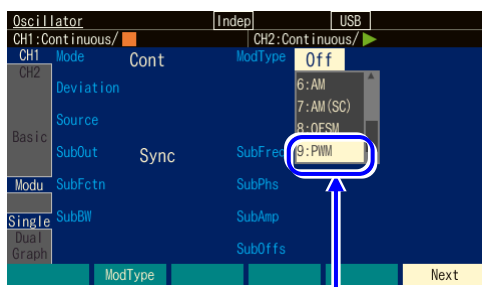

Set the modulation type [ModType] to PWM [PWM] on page 2 of the setting screen.

Select [PWM] in the modulation type setting menu

#### c) Waveform or mode where PWM is unavailable

PWM can be performed for only a square wave and pulse wave.

PWM cannot be performed for other waveforms.

PMW cannot be performed when duty sweep.



### d) Setting items necessary for PWM

Set the carrier duty [Duty] on page 1 of the setting screen.

Set the peak duty deviation [Deviation] on page 4 of the setting screen.

The output duty is changed within the range of carrier duty  $\pm$  peak duty deviation.

When the pulse-wave is used, the pulse width of the carrier is fixed to the duty setting and cannot be set with time.

When the modulation source [Source] is internal [Int], set the modulation waveform [ModFctn], modulation frequency [ModFreq], and modulation phase [ModPhs]. Internal [Int] cannot be selected during sweep oscillation mode.

When the modulation source [Source] is external [Ext]/[Ext1]/[Ext2], input a modulating signal to the external modulation/addition input terminal. It reaches the specified peak duty deviation at  $\pm 1$  V input.

## 4.8 Setting and Operation of Sweep

### 4.8.1 Sweep type (Sweep type)

Sweep can be done for the following five types:

- Frequency sweep P.4-93
- Phase sweep P.4-95
- Amplitude sweep P.4-97
- DC offset sweep P.4-99
- Duty sweep P.4-101

### 4.8.2 Screen for Setting and Operation of Sweep

This section describes the common screen configuration in the sweep oscillation mode.

Perform configuration and operation in the Oscillator setting screen. When you press the MENU key while another screen is displayed, the Top menu is displayed. Select [Oscillator] and then press the ENTER key.

#### a) To set the oscillation mode to sweep



Select [Sweep] in [Mode] and then press the ENTER key.

Press the MODE key to open the oscillation mode selection list. Select sweep oscillation mode [Sweep] and then press the ENTER key. This switches to the sweep oscillation mode. To display the parameters specific to the sweep oscillation mode, switch the page with the Next soft key.

#### b) Page 1 of the setting screen: Basic parameter setting screen

These are common items which are independent of the oscillation mode. Some settings are invalid depending on the sweep type.

This indicates that the oscillation mode is sweep.

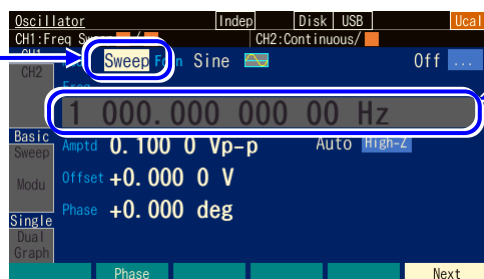

The parameter selected in [SweepType] cannot be changed.

### c) Page 2 of the setting screen: Screen for Setting the Sweep

The following figure is an example of selecting the frequency as a sweep type.

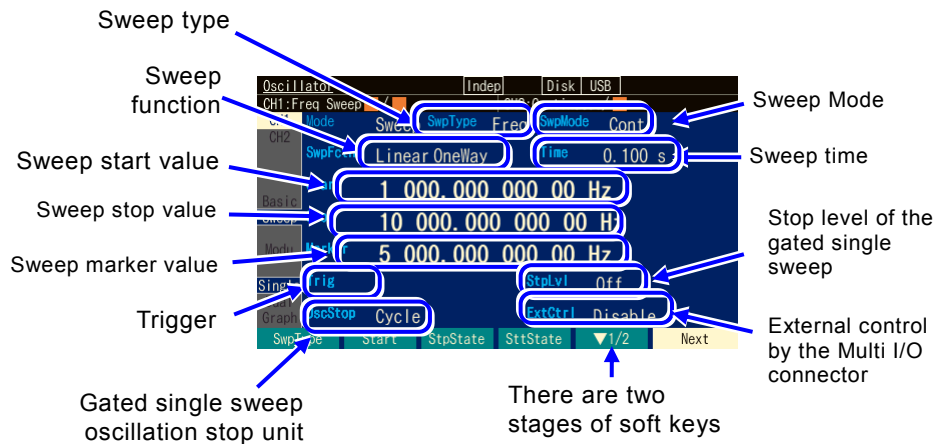

- Sweep type [SwpType]  
This is the item to sweep. Select from frequency, phase, amplitude, DC offset, and duty. ☞ P.4-83
- Sweep function [SwpFctn]  
This is the sweep form. Select from one-way and shuttle. Linear and log are available only when the sweep type is frequency. ☞ P.4-84
- Sweep start value[Start]  
This is the start value of sweep. ☞ P.4-83
- Sweep stop value [Stop]  
This is the stop value of sweep. ☞ P.4-83
- Sweep marker value [Marker]  
This is the marker value of sweep. ☞ P.4-89
- Trigger source [Trig]  
This is the trigger condition of single sweep and gated single sweep. Select internal or external as the trigger source. ☞ P.4-87
- Oscillation stop unit [OscStop] in gated single sweep  
This is the oscillation stop unit in gated single sweep. Select from 1 cycle unit and half cycle unit. Usually, set this to 1 cycle unit. ☞ P.4-86
- Sweep Mode [SwpMode]  
This is the oscillation style of sweep. Select from continuous sweep, single sweep, and gate single sweep. ☞ P.4-84
- Sweep time [Time]  
This is the transition time to sweep from the start value to stop value.

- Stop level [StpLvl]
 

This is the signal level when gated single sweep is stopped. Set the level by specifying Off or On. Normally, set this to Off. [P.4-86](#)
- External control [ExtCtrl] via Multi I/O connector
 

Enable or disable external control by the Multi I/O connector. [P.4-91](#)

**d) Page 4 of the setting screen: screen for setting the modulation function and synchronization/sub output terminal**

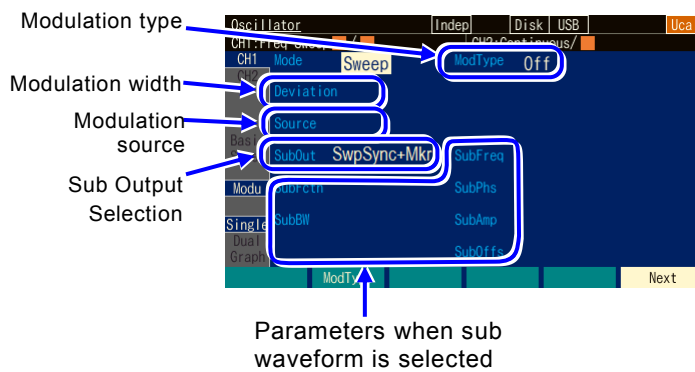

- Modulation type [ModType]
 

These are the types of modulation. Select from FM, PM, AM, AM (DSB-SC), DC offset modulation, PWM, and Off. [P.4-66](#)

FSK, PSK, and sweep target parameters cannot be selected in sweep oscillation mode.
- Modulation width [Deviation, Depth, HopFreq]
 

This is the modulation width. The item name changes with the modulation type. [P.4-66](#)
- Modulation source [Source]
 

The modulation source is fixed to external [Ext] in sweep oscillation mode. Internal [Int] cannot be selected.
- Sub output selection [SubOut]
 

Select the output signal from the synchronization/sub output terminal. Choose from the selection list. [P.4-68](#)

If [SubFctn] is selected, the sub waveform can be used. [P.4-128](#)

### 4.8.3 Common Setting and Operation of Sweep

This section describes the common settings and operations regardless of the items to sweep all together.

**a) To sweep oscillation mode**



Select [Sweep] in [Mode] and then press the ENTER key.

Press the MODE key to open the oscillation mode selection list. Select sweep oscillation mode [Sweep].

This switches to the sweep oscillation mode. To display the parameter screen specific to the sweep oscillation mode, switch the page with the Next soft key.

**b) To select sweep object**



Set the sweep type to [Freq]

Select the object to sweep in sweep types [SwpType] on page 2 of the setting screen from the following five items.

- Frequency Sweep [Freq] P.4-93
- Phase sweep [Phase] P.4-95
- Amplitude sweep [Amptd] P.4-97
- DC offset sweep [Offset] P.4-99
- Duty sweep [Duty] P.4-101

**c) To set the range and time to sweep**

Set the following items.

- Start value [Start]
- Stop value [Stop]
- Sweep time [Time]: Time to change from the start value to stop value.

For details, see the description of each sweep type.

**d) To set the sweep range with center and span**

When the input field of the start/stop value is opened and the current value is displayed, the [Center] or [Span] soft key is displayed. When this key is pressed, the input field of the center/span value is opened, and the displayed items are changed from [Start] or [Stop] to [Center] or [Span] respectively.

The [Center] or [Span] soft key is also changed to [Start] or [Stop]. When the [Start] or [Stop] soft key is pressed here, the input field of the start/stop value is opened.

The center value is the average of the start value and stop value. The span value is the absolute

value of difference of the start value and stop value. If the log sweep of the frequency is selected, the center value is an arithmetic average of the start and the stop value.

If it is changed to the center value or span value, the magnitude relationship of the start value and stop value is maintained.

**e) To sweep as sawtooth wave**

Set the sweep function [SwpFctn] on page 2 of the setting screen to one-way [OneWay].

For frequency sweep, linear [Lin] or log [Log] is available for the slope.

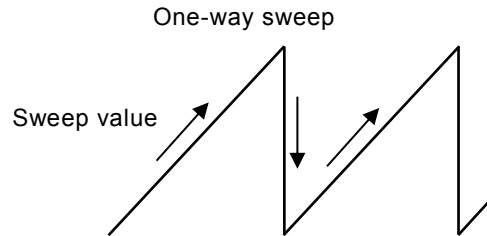

**f) To sweep as triangular waveform**

Set the sweep function [SwpFctn] on page 2 of the setting screen to shuttle [Shuttle].

For frequency sweep, linear [Lin] or log [Log] is available for the slope.

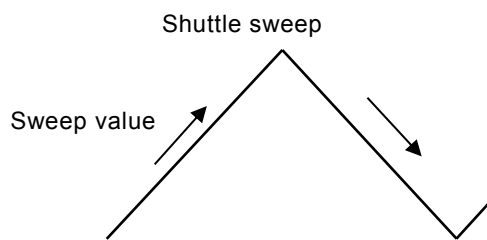

**g) To change upward/downward direction of sweep**

When sweep is performed with a sawtooth waveform (one-way sweep), the sweep is performed from the start value toward the stop value. The value increases when the start value < stop value during the sweep. Conversely, the value decreases when the start value > stop value during the sweep.

When the [Stt⇌Stp] soft key of the soft key set (displayed as [▼ 2/2] on the right end soft key) on the second row of page 2 of the setting screen is pressed, the start value and stop value are swapped.

**h) To repeat sweep continuously**

Set the sweep mode [SwpMode] on page 2 of the setting screen to continuous [Cont].

A trigger signal is not necessary.

Set the time to change from the start value to stop value in sweep time [Time] on the same page 2. Since the sweep time is the time to change from the start value to stop value, the repeating period is twice the sweep time setting as shown in following figure when the sweep function is shuttle.

Continuous one-way sweep

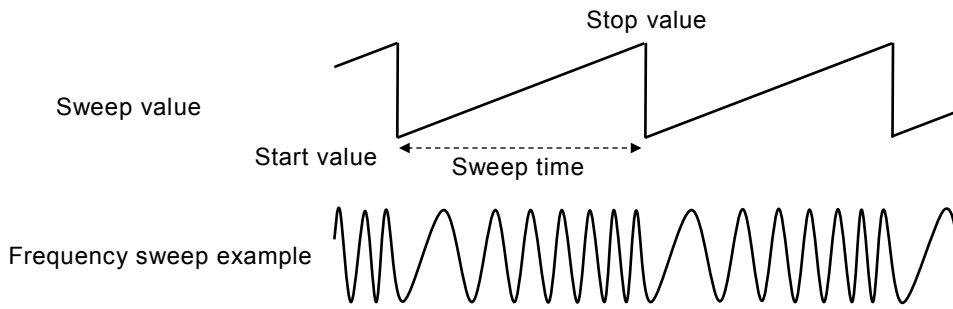

Continuous shuttle sweep

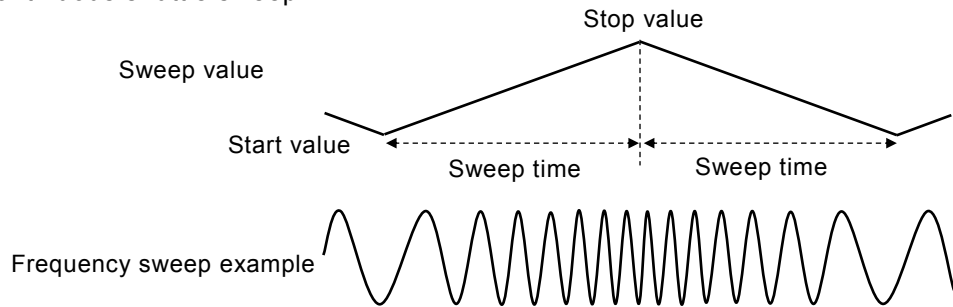

i) To start sweep with trigger

Set the sweep mode [SwpMode] on page 2 of the setting screen to single [Single].

Since a trigger signal is necessary, set a trigger source in trigger [Trig] on the same page 2. For the trigger setting, see P.4-87.

Set the time to change from the start value to stop value in sweep time [Time] on the same page 2.

The sweep is performed once in single sweep every time a trigger is accepted. If a trigger is received during a sweep, the sweep will resume from the start value.

The appearance of the change is different as shown in the following figure depending on whether the sweep function is one-way or shuttle sweep.

In case of one-way sweep, the start value is immediately returned to after the sweep ends.

In case of shuttle sweep, processing switches to standby in the sweep terminated state after the sweep ends.

Single one-way sweep

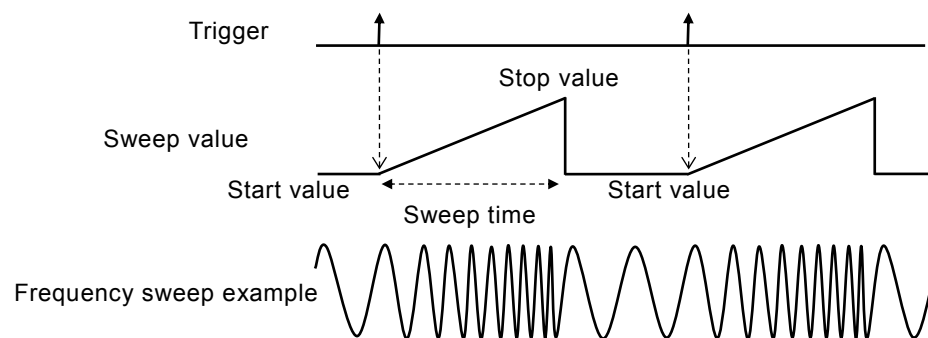

### Single shuttle sweep

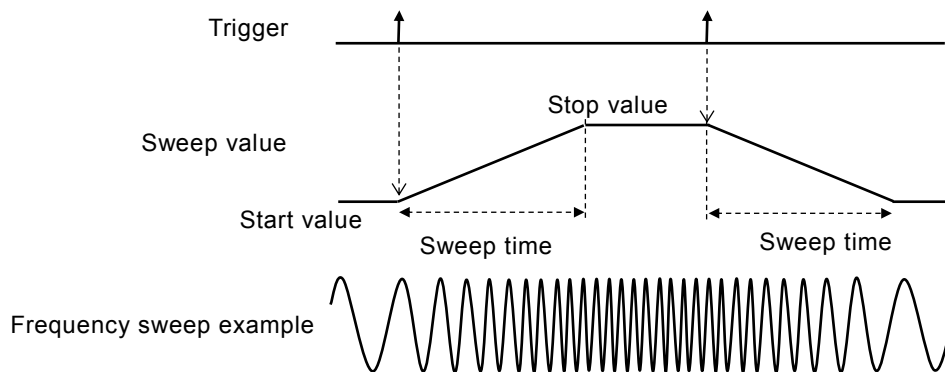

#### j) To output waveform only when sweep running

Set the sweep mode [SwpMode] on page 2 of the setting screen to gated single [Gated]. This is an operation that combines gate oscillation with sweep. Sweeps start with a trigger. Since a trigger signal is necessary, set a trigger source in trigger [Trig] on the same page 2. For the trigger setting, [P.4-87](#).

#### ■ Start oscillation/stop phase

Set the start oscillation/stop phase in phase [Phase] on page 1 of the setting screen.

However, in phase sweep, the start phase setting is the oscillation start phase, and the stop phase setting is the oscillation stop phase.

#### ■ Stop level

When you want to determine the level while oscillation is stopped separately from the phase, set the stop level [StpLvl] on page 2 of the setting screen to On [On], and then set the level as a % value based on the amplitude full scale. When [Off] is selected, the signal level while oscillation is stopped is determined depending on the phase set in [Phase] on page 1 of the setting screen. For the stop level, [P.4-113](#).

#### ■ Oscillation stop unit (usually set as 1 cycle [Cycle])

When you want to stop the oscillation every half cycle, set the oscillation stop unit [OscStop] to half cycle [HalfCycle] on page 2 of the setting screen. Usually, set this to 1 cycle [Cycle].

When this is set as 1 cycle [Cycle], the oscillation is with an integer cycle.

Since the oscillation ends without fail every one cycle or half cycle, the oscillation time is usually longer than the time set in the sweep time setting.



Gated single one-way sweep

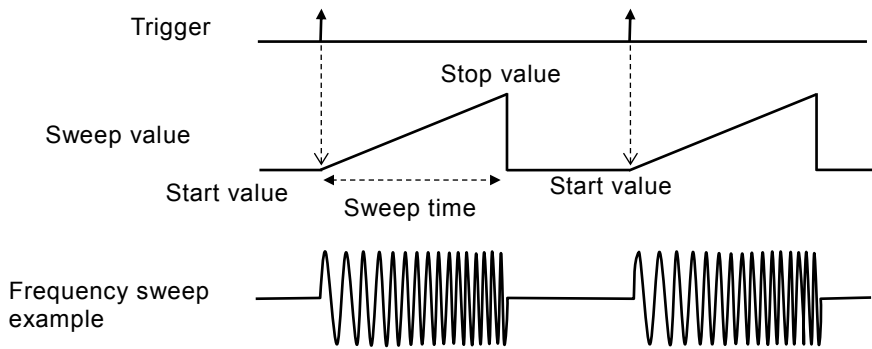

Gated single shuttle sweep

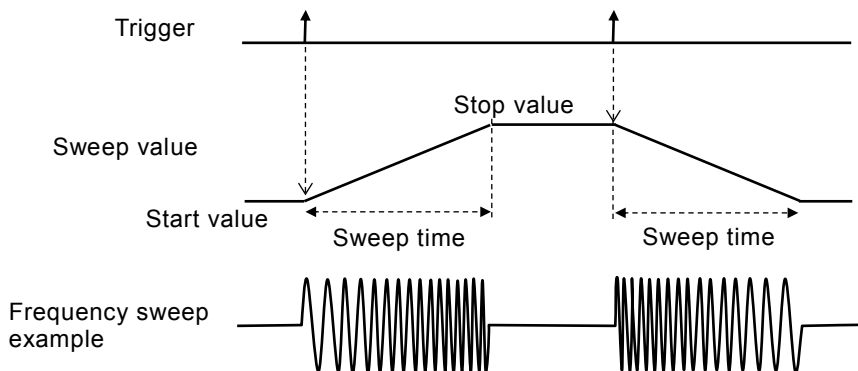

✓ Check

In phase sweep, the start phase setting is the oscillation start phase, and the stop phase setting is the oscillation stop phase.

k) To set the trigger condition of single sweep and gated single sweep

Internal trigger oscillator, external signal, manual trigger operation, and remote trigger can be used as a trigger.

When a trigger is received, the Triggered lamp on the TRIG key lights up.

A trigger condition is set in the trigger [Trig] on page 2 of the setting screen.

■ Trigger source setting

A trigger source can be selected from internal [Int]/[Int1]/[Int2] or external [Ext]/[Ext1]/[Ext2]. The trigger cycle of an internal trigger and the polarity/threshold of an external trigger can be set. The trigger source is common to the synchronization source of the sweep trigger, burst trigger, and synclator.

When a trigger source is external [Ext]/[Ext1]/[Ext2], input a trigger signal with a TTL level to the external trigger input terminal (TRIG IN).

Operations to start and stop a sweep can be performed independently of the trigger source setting with a logic signal input to the Multi I/O connector. P.4-91

### ■ How to use manual and remote triggers

Manual trigger operation and remote trigger operation is effective, regardless of the trigger source setting.

The [Start] soft key and TRIG key can be used for manual trigger operation.

However, in the case of WF1984, the TRIG key only works on the channel side where the display is active. For the channel where the display is active, [P.4-23](#)

When only manual trigger operation and remote trigger operation are used for a trigger, we recommend setting the trigger source to external [Ext] and polarity to [Off].

### l) To start a sweep

In continuous sweep, the sweep starts automatically when the mode becomes sweep oscillation mode. However, if the sweep setting is inappropriate, sweep oscillation will not start ([CNFLC] (Conflict) is displayed in the channel status area). When the [?] soft key displayed on the left end is pressed, a message about the inappropriate setting will be displayed. When the setting is changed to an appropriate setting, sweep oscillation starts. [P.14-9](#)

If sweep is stopped, press the [Start] soft key to start the sweep. If the [Start] soft key is not displayed, press the [▼2/2] soft key on the right end to toggle the soft key set.

In case of single sweep or gated single sweep, when a trigger is accepted, the sweep is started. However, if the sweep setting is inappropriate, a trigger cannot be accepted ([CNFLC] (conflict) is displayed in the channel status area). When the [?] soft key displayed on the left end is pressed, a message about the inappropriate setting is displayed. When it is changed to an appropriate setting, a trigger can be accepted. [P. 14-9](#)

The [Start] soft key and the manual trigger key on the panel operate as manual trigger operation, regardless of the trigger source setting.

### m) To pause sweep

When the [Stop] soft key is pressed while sweep is running, the sweep stops and enter the state to output a sweep start value (not stop value). If the [Stop] soft key is not displayed, press the [▼2/2] soft key at the right end to toggle the soft key set.

However, in case of single sweep or gated single sweep, when a new trigger is accepted, the sweep is started again.

### n) To pause sweep temporarily

When the [Hold] soft key is pressed while a sweep is running, the sweep is paused. When the [Resume] soft key is pressed afterwards, the sweep is resumed at the point where it was paused. If the [Hold] or [Resume] soft key is not displayed, press the [▼2/2] soft key at the right end to toggle the soft key set.

However, in case of single sweep or gated single sweep, when a new trigger is accepted during hold, the sweep is started from the beginning.

The [Hold] and [Resume] soft keys are located in the same position, with [Hold] displayed during a sweep, and [Resume] during a hold.

**o) To output the sweep start value**

When the [SttState] soft key is pressed, the state becomes the sweep start value output state.

You can check the state of the equipment under test from the sweep start value.

The [SttState] soft key is displayed in the output state for the sweep start value or stop value.

If the [SttState] soft key is not displayed, press the [▼2/2] soft key at the right end to toggle the soft key set.

In case of gated single sweep, the state will become oscillation with the start value. To stop the oscillation, press the [Stop] soft key.

**p) To output the sweep stop value**

When the [StpState] soft key is pressed, the state becomes the sweep stop value output state.

You can check the state of the equipment under test from the sweep stop value.

The [StpState] soft key is displayed when the output state is other than for the sweep stop value. If the [StpState] soft key is not displayed, press the [▼2/2] soft key at the right end to toggle the soft key set.

In case of gated single sweep, the state will become oscillation status with the stop value. To stop the oscillation, press the [Stop] soft key.

**q) To output a sweep synchronization signal and sweep marker signal**

Set this in synchronization/sub output [SubOut] on page 3 of the setting screen. Select from the following four options:

- Signal synchronized with reference phase of waveform [Sync]
- Signal synchronized with sweep [SwpSync]
- Signal combining a marker signal with a signal synchronized with sweep [SwpSync+Mkr]
- Off [Off]

■ When [Sync] is selected

A signal with TTL level which rises at the reference phase of the waveform is output from the synchronization/sub-output terminal.

■ When [SwpSync] is selected

A signal with TTL level which is synchronized with the sweep is output from the synchronization/sub-output terminal. It changes from high to low when the sweep starts.

When observing a signal during sweep execution with an oscilloscope or similar device, you can use the signal as a trigger signal of the oscilloscope.

■ When [SwpSync+Mkr] is selected

The rising of sweep synchronous output is a marker signal. The sweep synchronous output is low until it reaches the marker value from the sweep start value. The sweep synchronization output does not change on the return path of a shuttle sweep.

The timing at which the signal under sweep passes the marker value can be known.

However, there are the following restrictions for the time zone when a synchronous sweep output is at a low level.

- The time zone is limited to about 0.05% to 99.95% of the sweep time. Therefore, the time zone does not change even if the marker value is changed when the marker value is close to the start value or the stop value.
- The resolution of the time zone is limited to 1/32768 of the sweep time or 2.38ns, whichever is the larger. Therefore, the time zone does not necessarily change even if the marker value is changed finely.

Single sweep and gated single sweep

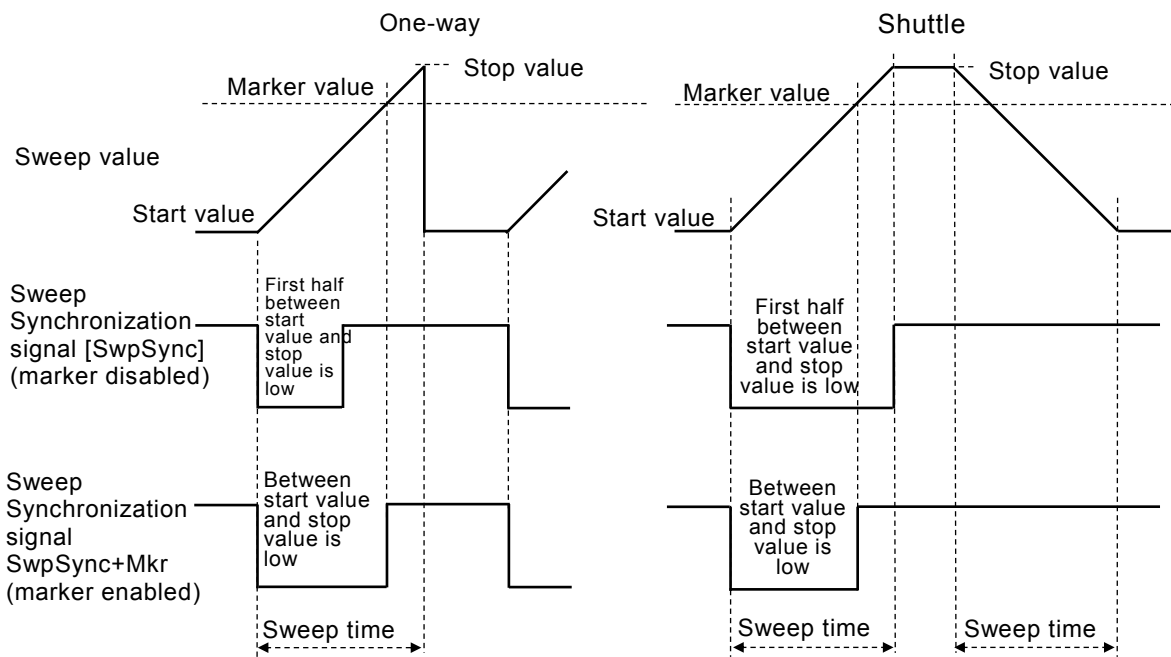

Continuous sweep

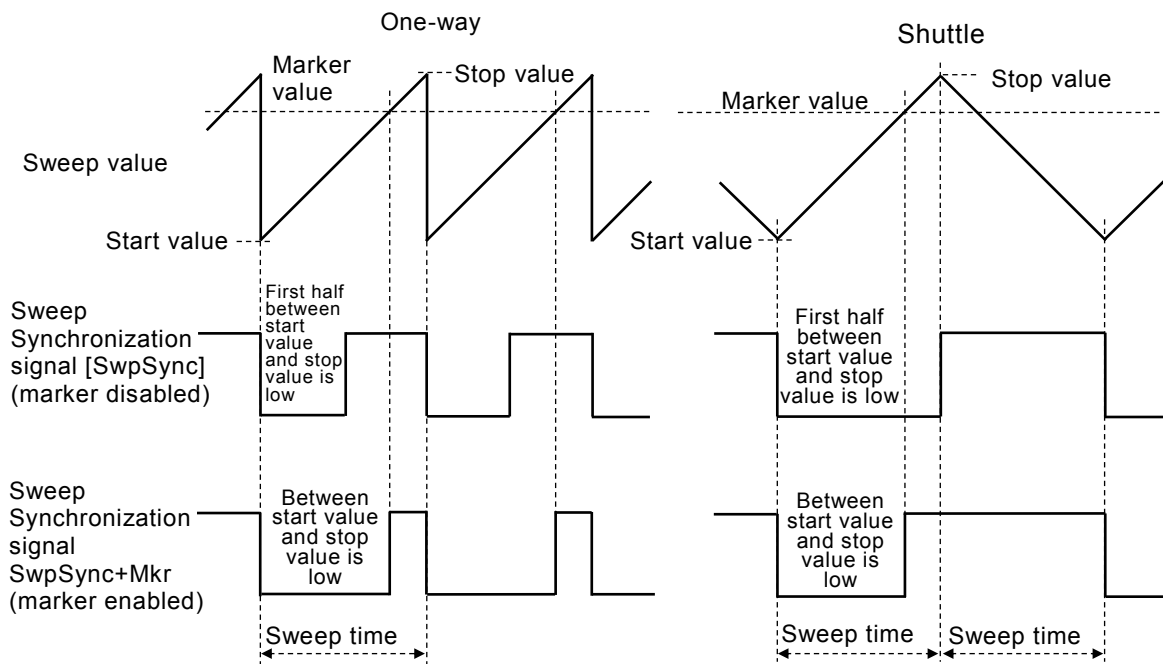

■ When [Off] is selected

The output will be at a low level. This helps to reduce interference from a ground common with externally connected devices or from a synchronization output signal

r) To substitute a center value with a marker value or substitute a marker value with a center value

When the [Ctr⇒Mkr] soft key is pressed on page 2, a center value is substituted with a marker value. When the [Mkr⇒Ctr] soft key is pressed, conversely a marker value is substituted with a center value.

If these soft keys on page 2 of the setting screen are not displayed, press the [▼1/2] soft key at the right end to toggle the soft key set.

s) To control the sweep start, stop, and pause with an external logic signal

Set the external control [ExtCtrl] to enable [Enable] on page 2 of the setting screen to conduct sweep operations with a TTL level logic input to the Multi I/O connector on the rear panel. This is shared by CH1 and CH2.

It is recommended that this be set to disable [Disable] when not using an external control signal in order to avoid malfunctions caused by external noise. For pin number assignment, see P.3-14

The following operations can be performed.

■ **Sweep start (pin 14)**

Falling input to pin 14 starts the sweep.

The sweep will restart from the beginning even if it is already running.

In the case of a single sweep or a gated single sweep, the sweep will start from the beginning when a trigger is received. The operation is a logical sum with the trigger source that is set.

■ **Sweep stop (pin 13)**

Falling input to pin 13 stops the sweep, and the output returns to the sweep start value.

However, in the case of a single sweep or a gated single sweep, the sweep will start from the beginning when a new trigger is received.

■ **Sweep hold/resume (pin 12)**

Falling input to pin 12 holds the sweep if it is running.

If the sweep is temporarily stopped, it will restart from the hold position.

However, if a new trigger is received while a single sweep or gated single sweep is temporarily stopped, the sweep (out-going or return for shuttle) will start from the beginning.

### 4.8.4 Setting Frequency Sweep

For details on the sweep setting screen and common operation method, see P.4-80 and P.4-83

#### a) Frequency sweep example

Examples of a continuous sweep and linear shuttle.

Shuttle sweep

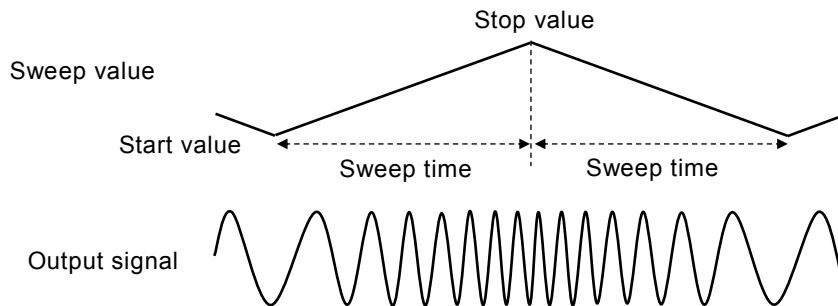

#### b) To select frequency sweep

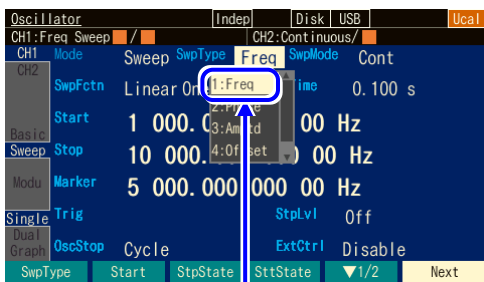

In the sweep type setting menu, select [Freq].

When the oscillation mode [Mode] is set to sweep oscillation mode [SWEEP], select the sweep type [SwpType] on page 2 of the setting screen to display the selection list. Select frequency [Freq] to set frequency sweep.

#### c) Waveform or mode where frequency sweep is unavailable

Frequency sweep cannot be performed for noise, pulse, and DC.

FSK, FM and PSK modulation are canceled (modulation function is turned off) when frequency sweep is selected.

#### d) Items necessary for frequency sweep

Set the following items on page 2 of the setting screen. The frequency setting on page 1 of the setting screen becomes invalid and the current oscillation frequency is displayed.

- Starting frequency [Start]  
The frequency range depends on the waveform.
- Stop frequency [Stop]  
The frequency range depends on the waveform.
- Sweep time [Time]  
Time to change from the start frequency to stop frequency. [P.4-83](#)
- Sweep Mode [SwpMode]

Select from continuous, single, and gated single. ⓘ P.4-84

- Sweep function [SwpFctn]

Select from one-way/shuttle and linear/log. ⓘ P.4-84

This can be set with center frequency [Center] and span frequency [Span], instead of start frequency and stop frequency. ⓘ P.4-83

When the sweep mode is single or gated single, it is necessary to set the trigger condition [Trig].

ⓘ P.4-87

Set the following items as needed:

- Marker frequency [Marker] (page 2 of the setting screen) ⓘP.4-89

- Stop level [StpLvl] (page 2 of the setting screen) ⓘP.4-86

The setting used for gated single sweep only.

- Oscillation stop unit of the gated single sweep [OscStop] (page 2 of the setting screen)

ⓘ P.4-86

The setting used for gated single sweep only.

- Synchronization/sub output selection [SubOut] (page 3 of the setting screen) ⓘ P.4-89



### 4.8.5 Setting Phase Sweep

For details on the sweep setting screen and the common operation method, see P.4-80 and P.4-83.

**a) Stop value Sweep value**

Examples of a continuous sweep and linear shuttle.

Shuttle sweep

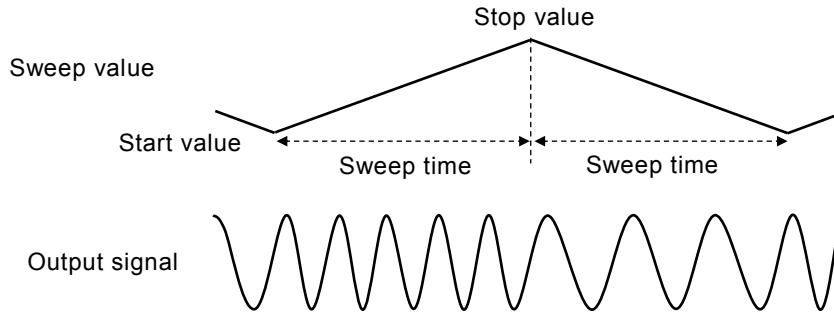

When the phase increases, the frequency rises by just the amount of the following value. When the phase decreases, the frequency falls by just the amount of the following value.

$$\frac{\text{Stop phase (deg)} - \text{Start phase (deg)}}{360} \times \frac{1}{\text{Sweep time (sec)}}$$

**b) To select phase sweep**



Select [Phase] in the sweep type setting menu

When the oscillation mode [Mode] is set to sweep oscillation mode [SWEEP], select the sweep type [SwpType] on page 2 of the setting screen to display the selection list. Select phase [Phase] to set phase sweep.

**c) Waveform or mode where phase sweep is unavailable**

Phase sweep cannot be performed for an arbitrary waveform, parameter-variable waveform, noise, and DC.

FSK, PSK and PM modulation are canceled (modulation function turned off) when phase sweep is selected.

**d) Items necessary for phase sweep**

Set the following items on page 2 of the setting screen. The phase setting on page 1 of the setting screen becomes invalid, and the current phase is displayed.

- Start phase [Start]
- Stop phase [Stop]
- Sweep time [Time]  
Time to change from the start phase to stop phase. ⓘ P.4-83
- Sweep Mode [SwpMode]  
Select from continuous, single, and gated single. ⓘ P.4-84
- Sweep function [SwpFctn]  
Select from one-way and shuttle. ⓘ P.4-84

This can be set with center phase [Center] and span phase [Span], instead of start phase and stop phase. ⓘ P.4-83

When the sweep mode is single or gated single, it is necessary to set the trigger condition [Trig].  
ⓘ P.4-87

Set the following items as needed:

- Marker phase [Marker] (page 2 of the setting screen) ⓘP.4-89
- Stop level [StpLvl] (page 2 of the setting screen) ⓘP.4-86  
The setting used for gated single sweep only.
- Oscillation stop unit of the gated single sweep [OscStop] (page 2 of the setting screen)  
ⓘ P.4-86  
The setting used for gated single sweep only.
- Synchronization/sub output selection [SubOut] (page 3 of the setting screen) ⓘ P.4-89

### 4.8.6 Setting Amplitude Sweep

For details on the sweep setting screen and common operation method, see P.4-80 and P.4-83.

#### a) Amplitude sweep example

Examples of a continuous sweep and linear shuttle.

Shuttle sweep

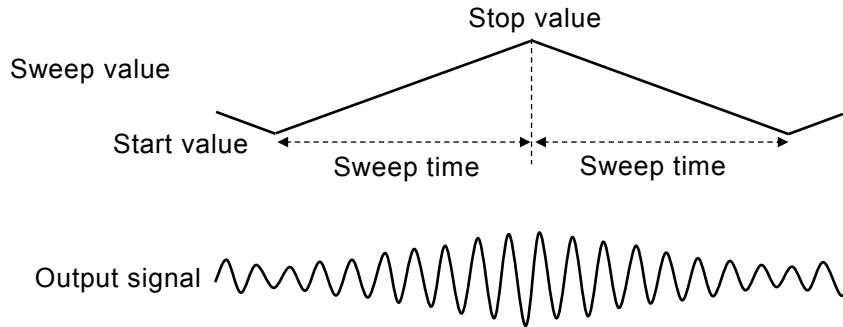

#### b) To select amplitude sweep



Select [Amptd] in the sweep type setting menu

When the oscillation mode [Mode] is set to sweep oscillation mode [SWEEP], select the sweep type [SwpType] on page 2 of the setting screen to display the selection list. Select amplitude [Amptd] to set amplitude sweep.

#### c) Waveform or mode where amplitude sweep is unavailable

Amplitude sweep cannot be performed for DC.

AM and AM (DSB-SC) modulation are canceled (modulation function turned off) when amplitude sweep is specified.

#### d) Items necessary for amplitude sweep

Set the following items on page 2 of the setting screen. The amplitude setting on page 1 of the setting screen becomes invalid, and the current amplitude is displayed.

- Start amplitude [Start]
- Stop amplitude [Stop]
- Sweep time [Time]  
Time to change from the start amplitude to stop amplitude. [P.4-83](#)
- Sweep Mode [SwpMode]  
Select from continuous, single, and gated single. [P.4-84](#)
- Sweep function [SwpFctn]

Select from one-way, shuttle. ⓘ P.4-84

This can be set with center amplitude [Center] and span amplitude [Span], instead of start amplitude and stop amplitude. ⓘ P.4-83

When the sweep mode is single or gated single, it is necessary to set the trigger condition [Trig]. ⓘ P.4-87

Set the following items as needed:

- Marker amplitude [Marker] (page 2 of the setting screen) ⓘP.4-89
- Stop level [StpLvl] (page 2 of the setting screen) ⓘP.4-86  
The setting used for gated single sweep only.
- Oscillation stop unit of the gated single sweep [OscStop] (page 2 of the setting screen) ⓘ P.4-86  
The setting used for gated single sweep only.
- Synchronization/sub output selection [SubOut] (page 3 of the setting screen) ⓘ P.4-89

### 4.8.7 Setting DC Offset Sweep

For details on the sweep setting screen and common operation method, see P.4-80, P.4-83.

#### a) DC offset sweep example

Examples of a continuous sweep and linear shuttle.

Shuttle sweep

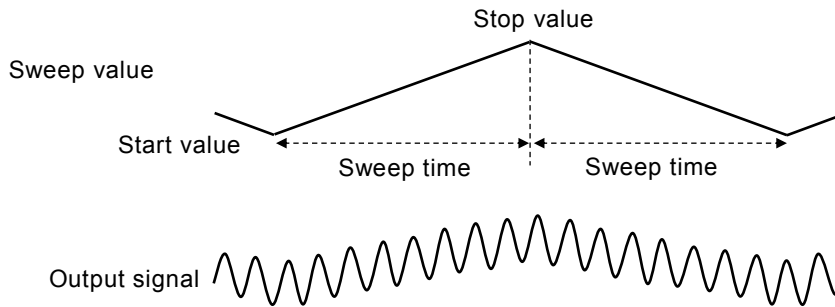

#### b) To select DC offset sweep



Select [Offset] in the sweep type setting menu

When the oscillation mode [Mode] is set to sweep oscillation mode [SWEEP], select the sweep type [SwpType] on page 2 of the setting screen to display the selection list. Select DC offset [Offset] to set DC offset sweep.

#### c) Waveform or mode where DC offset sweep is unavailable

None. However, when DC is selected as a waveform, the DC level itself is swept. In addition, when DC is selected as a waveform, gated single sweep cannot be performed.

DC offset modulation is canceled (modulation function turned off) when DC offset sweep is specified.

#### d) Items necessary for DC offset sweep

Set the following items on page 2 of the setting screen. The DC offset setting on page 1 of the setting screen becomes invalid, and the current DC offset is displayed.

- Start DC offset [Start]
- Stop DC offset [Stop]
- Sweep time [Time]  
Time to change from the start DC offset to stop DC offset.  
☞ P.4-83
- Sweep Mode [SwpMode]  
Select from continuous, single, and gated single. ☞ P.4-84

- Sweep function [SwpFctn]  
Select from one-way, shuttle. ⓘ P.4-84

This can be set with center DC offset [Center] and span DC offset [Span], instead of start DC offset and stop DC offset. ⓘ P.

When the sweep mode is single or gated single, it is necessary to set the trigger condition [Trig].  
ⓘ P.4-87

Set the following items as needed:

- Marker DC offset [Marker] (page 2 of the setting screen) ⓘP.4-89
- Stop level [StpLvl] (page 2 of the setting screen) ⓘP.4-86  
The setting used for gated single sweep only.
- Oscillation stop unit of the gated single sweep [OscStop] (page 2 of the setting screen)  
ⓘ P.4-86  
The setting used for gated single sweep only.
- Synchronization/sub output selection [SubOut] (page 3 of the setting screen) ⓘ P.4-89

### 4.8.8 Setting Duty Sweep

For details on the sweep setting screen and common operation method, see P.4-80 and P.4-83.

#### a) Duty sweep example

Examples of a continuous sweep and linear shuttle.

Shuttle sweep

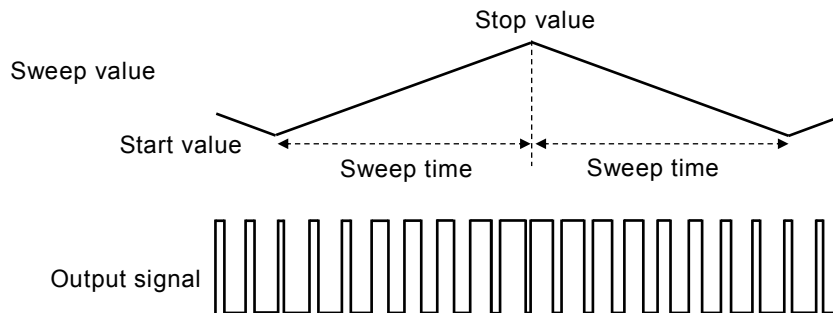

#### b) To select duty sweep



Select [Duty] in the sweep type setting menu

When the oscillation mode [Mode] is set to sweep oscillation mode [SWEEP], select the sweep type [SwpType] on page 2 of the setting screen to display the selection list. Select [Duty] to set duty sweep.

#### c) Waveform where duty sweep is available

Square wave and pulse wave are available.

PWM modulation is canceled (modulation function turned off) when duty sweep is specified.

#### d) Setting items necessary for duty sweep



Set the following items on page 2 of the setting screen. The duty setting on page 1 of the setting screen becomes invalid and the current duty is displayed.

- Start duty [Start]
 

The range of duty depends on the frequency. In the case of pulse wave, it also depends on the leading and trailing edge times. ☞ P.4-48, P.4-50
- Stop duty [Stop]
 

The range of duty depends on the frequency. In the case of pulse wave, it also depends on the leading and trailing edge times. ☞ P.4-48, P.4-50
- Sweep time [Time]
 





Time to change from the start duty to stop duty. ☞ P.4-83

- Sweep Mode [SwpMode]  
Select from continuous, single, and gated single.  P.4-84
- Sweep function [SwpFctn]  
Select from one-way, shuttle.  P.4-84

This can be set with center duty [Center] and span duty [Span], instead of start duty and stop duty.  
 P.4-91

When sweep mode is single or gated single, it is necessary to set the trigger condition [Trig].  
 P.4-87

Set the following items as needed:

- Marker duty [Marker] (page 2 of the setting screen)  P.4-89
- Stop level [StpLvl] (page 2 of the setting screen)  P.4-86  
The setting used for gated single sweep only.
- Oscillation stop unit of the gated single sweep [OscStop] (page 2 of the setting screen)  
 P.4-86  
The setting used for gated single sweep only.
- Synchronization/sub output selection [SubOut] (page 3 of the setting screen)  P.4-89



## 4.9 Setting and Operation of Burst

### 4.9.1 Burst Oscillation Types (Burst mode)

The following four types of burst oscillations are available.

- Auto burst  
Repeats oscillating and stopping automatically with each specified wave number. A trigger signal is not necessary. [☞ P.4-106](#)
- Trigger burst  
Performs oscillation with the specified wave number every time a trigger is accepted. [☞ P.4-109](#)
- Gate oscillation  
Performs oscillation in an integer cycle or half-cycle unit while the gate is on.  
[☞ P.4-114](#)
- Triggered Gate Oscillation  
Gate oscillation that turns the gate on/off every time a trigger is accepted. [☞ P.4-119](#)

### 4.9.2 Screen for Setting and Operation of Bursts

This section describes the common screen configuration in the burst oscillation mode.

Perform configuration and operation in the Oscillator setting screen. When you press the MENU key while another screen is displayed, the Top menu is displayed. Select [Settings] and then press the ENTER key.

#### a) To set the oscillation mode to burst



Select [Burst] in [Mode] and then press the ENTER key.

Press the MODE key to open the oscillation mode selection list. Select burst oscillation mode [Burst]. ([☞ P.4-31](#)) This switches to burst oscillation mode.

To display the parameters specific to the burst oscillation mode, switch the page with the Next soft key.

#### b) Page 1 of the setting screen: Basic parameter setting screen

These are common items which are independent of the oscillation mode.

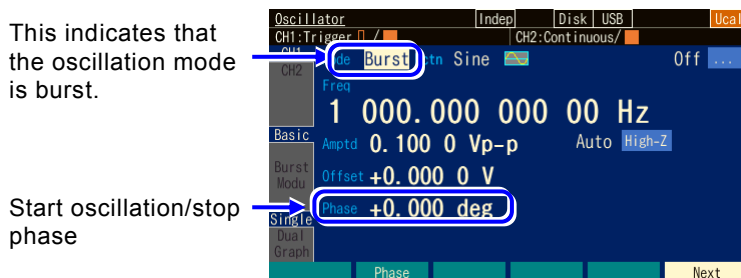

This indicates that the oscillation mode is burst.

Start oscillation/stop phase

**c) Page 3 of the setting screen: Screen for Setting Bursts**

Settings differ depending on the burst mode. This is explained for each burst mode.

**d) Page 4 of the setting screen: Screen for setting the modulation function and synchronization/sub output terminal**

The following figure shows an example with FM selected as the modulation type.

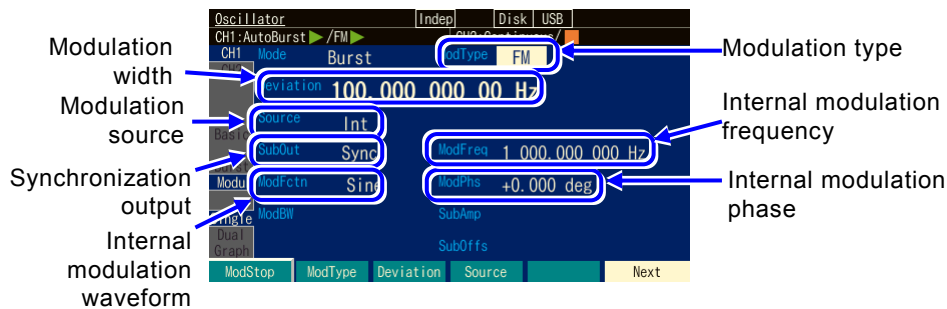

○ **Modulation type [ModType]**

These are the types of modulation. Select from FM, FSK, PM, PSK, AM, AM (DSB-SC), DC offset modulation, PWM, and Off. [P.4-66](#)

FSK and PSK can be selected only when the burst mode is auto burst [AutoBurst].

Modulation is applied always during oscillation and when stopped.

If you want to set the level while oscillation is stopped for PM to a constant level, set the stop level to On.

○ **Modulation width [Deviation, Depth, HopFreq]**

This is the modulation width. The item name changes with the modulation type. [P.4-66](#)

The modulation signal will have no effect on the waveform output when the modulation width is set to 0. Selecting internal for the modulation source and internal modulation waveform [ModFctn] in the sub output selection [SubOut] will output an internal modulation signal from the synchronization/sub output BNC terminal. At this time, the internal modulation signal can be used as an independent signal source by freely setting the waveform, frequency, phase, amplitude, and DC offset.

○ **Modulation source [Source]**



Select a modulation source from internal [Int]/[Int1]/[Int2] or external [Ext]/[Ext1]/[Ext2].

[P.4-66](#)

○ **Internal modulation waveform [ModFctn]/Sub waveform [SubFctn]**

Set the waveform for the internal modulation source when the modulation function is turned on and set to internal modulation. Select from the sine wave, square wave, triangle wave, rising ramp wave, falling ramp wave, noise, and arbitrary wave. [P.4-67](#)

Select the sub waveform output to the sub output when the modulation function is turned off or not set to internal modulation.

- Internal modulation frequency [ModFreq]  
This is the frequency of the internal modulation source.  P.4-67  
This item is not available when the modulation function is off or set to external modulation.
  
- Internal modulation phase [ModPhs]/Sub waveform phase [SubPhs]  
This is the phase of the internal modulation source when the modulation function is turned on and set to internal modulation. Change the phase difference between the reference phase of the internal modulation source and the waveform output.  
Set the sub waveform phase output to the sub output when the modulation function is turned off or set to external modulation.
  
- Sub output selection [SubOut]  
Select the output signal from the synchronization/sub output terminal. Choose from the selection list.  P.4-68
  
- Sub output amplitude [SubAmp]  
Set the output amplitude for when the internal modulation waveform and sub waveform are output from the synchronization/sub output terminal.
  
- Sub output offset [SubOfs]  
Set the output offset for when the internal modulation waveform and sub waveform are output from the synchronization/sub output terminal.

4.9.3 Auto burst

This repeats oscillating and stopping automatically with each specified wave number. A trigger signal is not necessary.

a) Auto burst example

Mark wave number (oscillation wave number): 3 waves, space wave number (stop oscillation wave number): 2 waves, start oscillation/stop phase: 30 degrees, stop level: In case of Off.

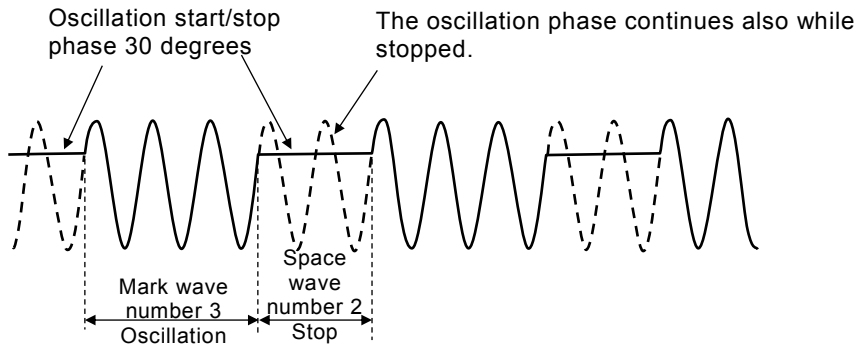

b) To set burst mode to auto burst



Select burst mode [BrstMode] on page 3 of the setting screen and then press the ENTER key to display the burst mode selection list. Select auto burst [AutoBurst] to set the auto burst mode.

Select [AutoBurst] in [BrstMode] and then press the ENTER key.

c) Screen for auto burst setting

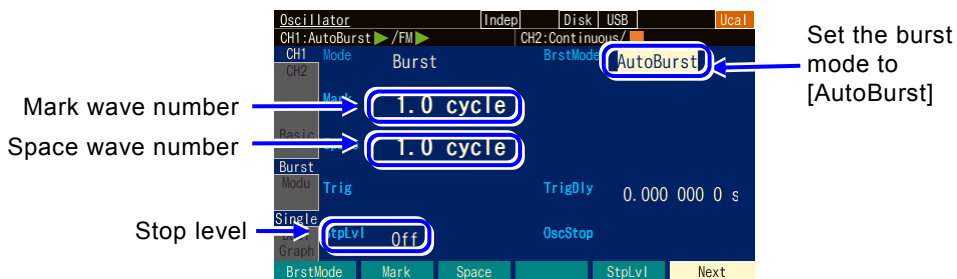

○ Burst mode [BrstMode]

Set the burst mode. Set the mode here to auto burst [AutoBurst].

- Mark wave number [Mark]  
This is the wave number of oscillation. This can be set in 0.5 cycle units. Usually, set this to 1 cycle unit.
- Space wave number [Space]  
This is the wave number to stop oscillation. This can be set in 0.5 cycle units. Usually, set this to 1 cycle unit.
- Stop level [StpLvl]  
This is the signal level while oscillation is stopped. Set the level by specifying Off or On.  
Usually, this is set to Off. ☞ P.4-108

**d) Waveform where auto is unavailable**

Auto burst cannot be performed for noise and DC.

**e) Setting items necessary for auto burst**

Set the oscillation start/stop phase [Phase] on page 1 of the setting screen.

Set mark wave number [Mark] and space wave number [Space] on page 2 of the setting screen.

Each wave number is usually set as an integer value.

The stop level [StpLvl] on page 2 of the setting screen is usually set to off [Off].

☞ P. 4-113

**f) To start auto burst → Started automatically**

In auto burst mode, burst starts automatically when the mode switches to burst-oscillation mode. However, if the sweep setting is inappropriate, the burst oscillation will not start ([Conflict] is displayed in the channel status area). When the [?] soft key displayed on the left end is pressed, a message about the inappropriate setting is displayed. When the setting is changed to an appropriate setting, burst oscillation starts. ☞ P.14-10

**g) To stop auto burst → Cannot**

Oscillation cannot be stopped while in auto burst mode.

To stop oscillation, set the burst mode [BrstMode] to a setting other than auto burst [Auto] on page 2 of the setting screen to prevent a trigger or gate signal from arriving.

To set as continues oscillation, change the oscillation mode to [CONT].

**h) To output a burst synchronization signal → In the synchronization/sub output settings**

Set this in synchronization output [SubOut] on page 3 of the setting screen. Select from the following table.

Modulation function is on and internal modulation	Modulation function is off or external modulation
Waveform reference phase synchronization [Sync]	Waveform reference phase synchronization [Sync]
Internal modulation synchronization [ModSync]	-
Burst synchronization [BrstSync]	Burst synchronization [BrstSync]
Internal modulation waveform [ModFctn]	Sub waveform [SubFctn]
Off [Off]	Off [Off]

■ When [Sync] is selected

A signal with TTL level which rises at the reference phase of the waveform is output from the synchronization/sub-output terminal.

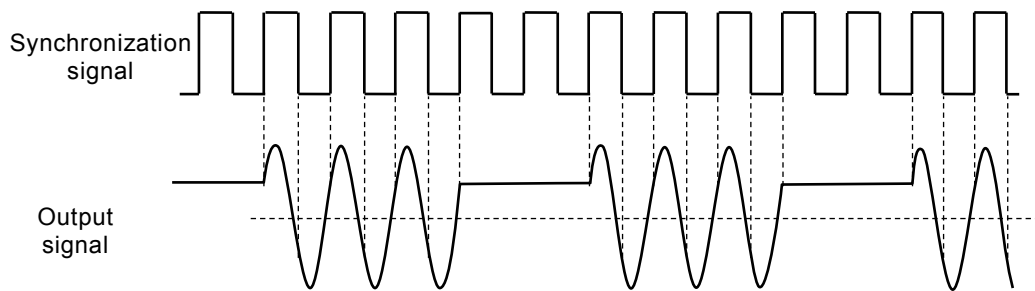

■ When [BrstSync] is selected

A signal with TTL level which is synchronized with the burst oscillation is output from the synchronization/sub-output terminal. It is low during oscillation, and high while oscillation is stopped, as show in the following figure.

When a signal under burst is observed with an oscilloscope or similar device, it can be used as a trigger signal of the oscilloscope.

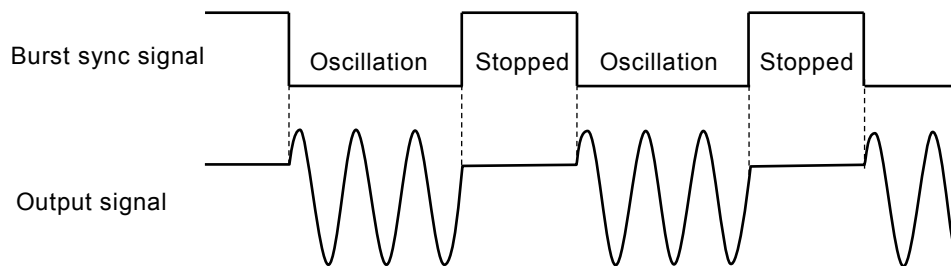

■ When [Off] is selected

The output will be at a low level. This helps to reduce interference from a ground common with externally connected devices or from a synchronization output signal.

i) How to use stop level

The level while oscillation is stopped is usually set by oscillation start/stop phase. It is also possible to set it by the ratio to the full scale of the amplitude independently.

Set the stop level [StpLvl] to on [On] on page 2 of the setting screen, and set the level as a % value. P.4-113

### 4.9.4 Trigger burst

This performs oscillation with the specified wave number every time a trigger is accepted.

**a) Trigger burst example**

Mark wave number (oscillation wave number): 4 waves, start oscillation/stop phase: 30 degrees, stop level: In case of Off.

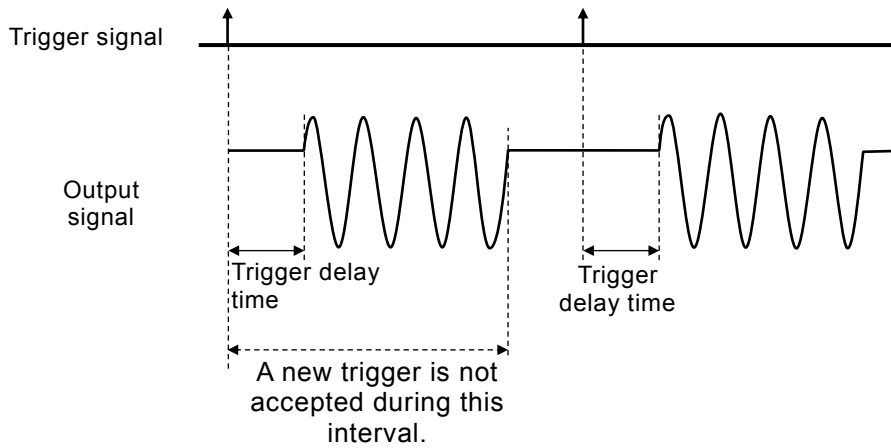

**b) To set burst mode to trigger burst**

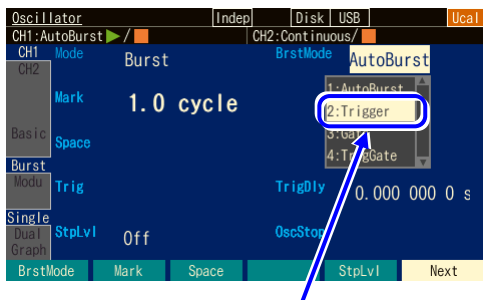

Select burst mode [BrstMode] on page 3 of the setting screen and then press the ENTER key to display the burst mode selection list. Select trigger burst [Trigger] to set the trigger burst mode.

Select [Trigger] in [BrstMode] and then press the ENTER key.

### c) Screen for trigger burst setting

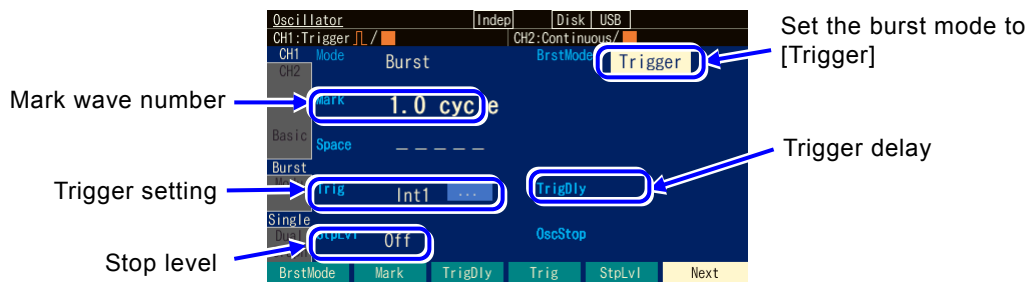

- Burst mode [BrstMode]  
Set the burst mode. This sets the trigger burst [Trigger].
- Mark wave number [Mark]  
This is the wave number for oscillation every time a trigger is accepted. This can be set from 0.5 to 999 999.9 in 0.5-cycle units or to Inf (infinite number of times).  
To set Inf, place the cursor over the leftmost digit and then press the up arrow key or turn the modify knob right.
- Trigger delay [TrigDly]  
This is the trigger delay time. Start oscillation when the specified time elapses after accepting a trigger. ☞ P.4-111
- Trigger [Trig]  
This is the trigger condition. Select a trigger source from internal and external. ☞ P.4-111
- Stop level [StpLvl]  
This is the signal level while oscillation is stopped. Set the level by specifying Off or On.  
Usually, set this to Off. ☞ P.4-113

### d) Waveform where trigger is unavailable

Trigger burst cannot be performed for noise and DC.

### e) Setting items necessary for trigger burst

Set the oscillation start/stop phase [Phase] on page 1 of the setting screen.

Set mark wave number [Mark] on page 2 of the setting screen. The mark wave number is usually set as an integer value.

The stop level [StpLvl] on page 2 of the setting screen is usually set to off [Off].

☞ P.4-113

A trigger is necessary for trigger burst. See the next section.



### f) Trigger setting for trigger burst

Internal trigger oscillator, external signal, manual trigger key operation, and remote trigger can be used as a trigger.

When a trigger is received, the Triggered lamp on the left of the TRIG key lights up.

Set the trigger source in trigger [Trig] on page 2 of the setting screen

#### ■ Trigger source setting

A trigger source can be selected from internal [Int]/[Int1]/[Int2] or external [Ext]/[Ext1]/[Ext2].

The trigger cycle of an internal trigger and the polarity/threshold of an external trigger can be set. The trigger source is common to the synchronization source of the sweep trigger, burst trigger, and synculator.

When a trigger source is external [Ext]/[Ext1]/[Ext2], input a trigger signal with a TTL level to the external trigger input terminal (TRIG IN/#1/#2).

#### ■ How to use manual and remote triggers

Manual trigger operation and remote trigger operation is effective, regardless of the trigger source setting.

The TRIG key can be used for manual trigger operation.

However, in the case of WF1984, the TRIG key only works on the channel side where the display is active. For the channel where the display is active, [P.4-23](#)

When only manual trigger operation and remote trigger operation are used for a trigger, we recommend setting the trigger source to external [Ext] and polarity to [Off].

#### ■ Trigger delay setting

Set the trigger delay time in the trigger [TrigDly] on page 2 of the setting screen. Start oscillation when the specified time elapses after accepting a trigger. The setting of the trigger delay time is effective for all trigger sources.

The delay inside the equipment is minimized when the trigger delay time is set as zero, but there is a delay in the waveform actually output. [P.7-2](#)

A new trigger is not accepted until oscillation of the specified number of mark waves completes.

### g) To start trigger burst → trigger

When a trigger is accepted, oscillation is performed with the specified wave number.

Internal trigger oscillator, external signal, manual trigger operation, and remote trigger can be used as a trigger.

The internal trigger oscillator setting is common to the sweep internal trigger oscillator and FSK/PSK internal trigger settings.

**h) To output a burst synchronous signal → Synchronous output setting**

Set this in synchronization output [SubOut] on page 3 of the setting screen. Select from the following table.

Modulation function is on and internal modulation	Modulation function is off or external modulation
Waveform reference phase synchronization[Sync]	Waveform reference phase synchronization[Sync]
Internal modulation synchronization [ModSync]	-
Burst synchronization [BrstSync]	Burst synchronization [BrstSync]
Internal modulation waveform [ModFctn]	Sub waveform [SubFctn]
Off [Off]	Off [Off]

■ When [Sync] is selected

A signal with TTL level which rises at the reference phase of the waveform is output from the synchronization/sub-output terminal.

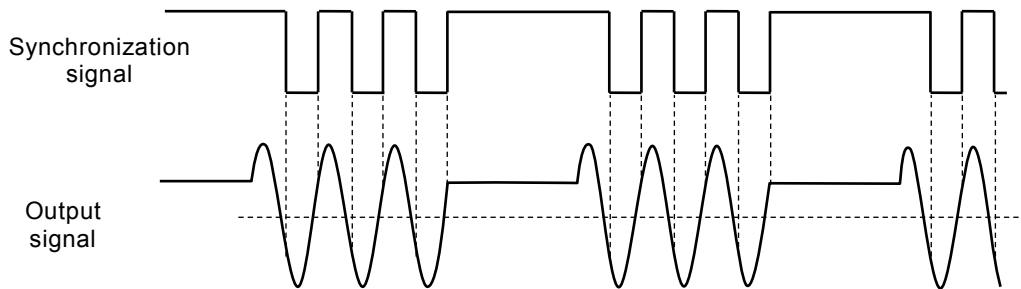

■ When [BrstSync] is selected

A signal with TTL level which is synchronized with the burst oscillation is output from the synchronization/sub-output terminal. It is low during oscillation, and high while oscillation is stopped, as show in the following figure.

When a signal under burst is observed with an oscilloscope or similar device, it can be used as a trigger signal of the oscilloscope.

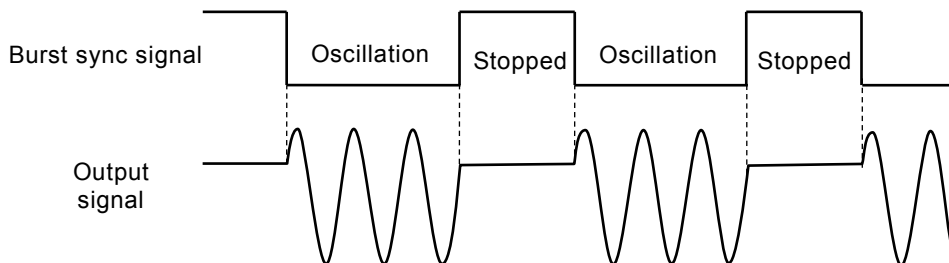

■ When [Off] is selected

The output will be at a low level. This helps to reduce interference from a ground common with externally connected devices or from a synchronization output signal.

i) How to use stop level

The level while oscillation is stopped is usually set by the oscillation start/stop phase. It is also possible to set it by the ratio to the full scale of the amplitude independently.

Set the stop level [StpLvl] to on [On] on page 2 of the setting screen, and set the level as a % value.

30 degrees, stop level: In case of Off. 3 waves, and oscillation start/stop phase: 30 degrees, stop level: Off, and -50% when on. Note that start oscillation/stop phase is still effective.

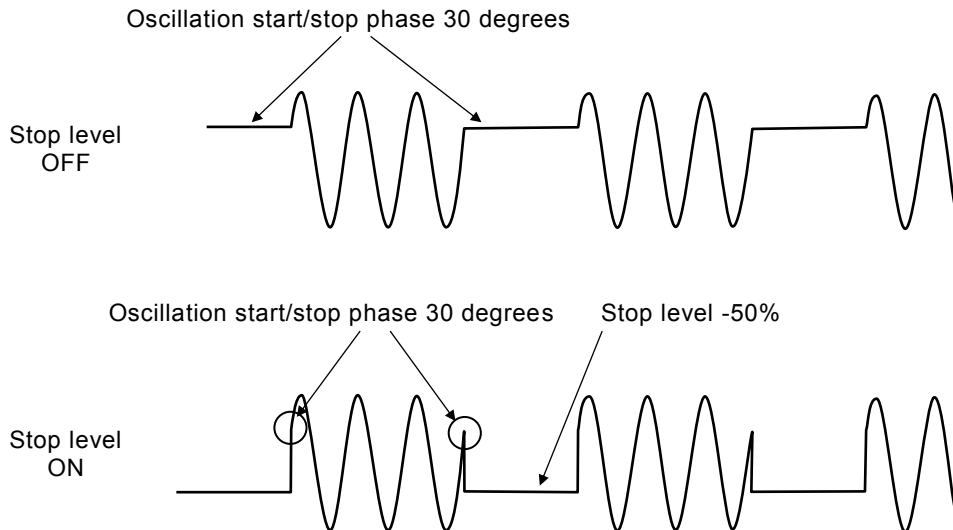

When the stop level is applied to the square wave, a square wave with three values can be output as shown in the following figure.

With the example in the figure, the stop level is set as 0% and the start oscillation/stop phase are set as 0° (both the standard and enhanced duty variable ranges are available). If the stop level is not applied, the level of square wave while oscillation is stopped is always either of a low level or high level.

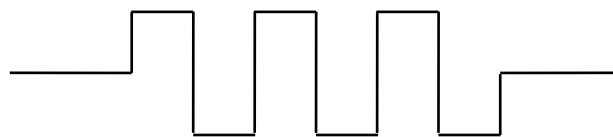

j) To perform burst an infinite number of times

If Inf is set for the mark wave number, oscillation will continue infinitely once a trigger is input. There are the following two way to stop oscillation.

○ Using the stop [Stop] soft key

Press the [Stop] soft key. Oscillation will then continue up until the number of cycle units specified in [OscStop] and then stop.

○ Set the burst mode to [Trigger] again.

Oscillation will stop immediately.

4.9.5 Gate Oscillation

This performs oscillation in an integer cycle or half-cycle unit while the gate is on.

a) Gate oscillation example

Start oscillation/stop phase: 30 degrees, Oscillation stop unit: 1 cycle, Stop level: In case of Off. The oscillation is stopped when the start oscillation/stop phase is reached after the gate signal turns off.

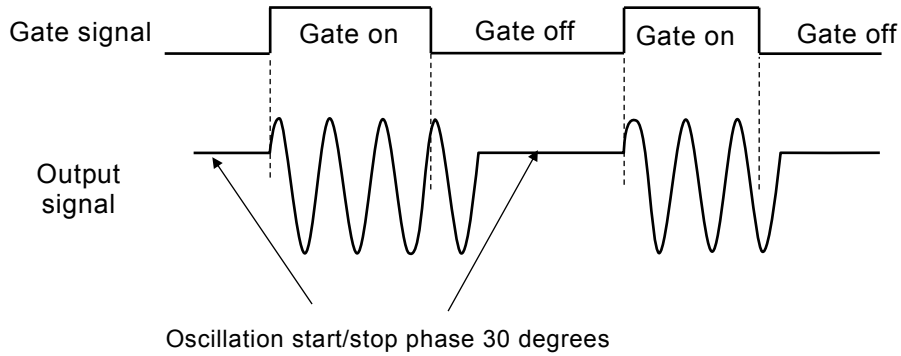

b) To set burst mode to gate oscillation

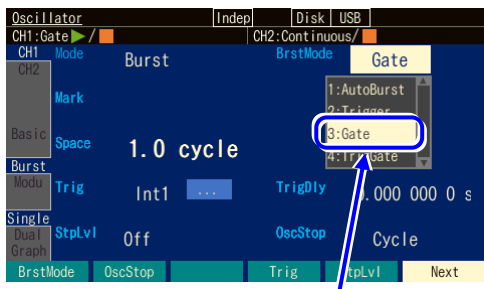

Select [Gate] in [BrstMode] and then press the ENTER key.

Select burst mode [BrstMode] on page 3 of the setting screen and then press the ENTER key to display the burst mode selection list. Select gate oscillation [Gate] to set the gate oscillation mode.

c) Screen for gate oscillation setting

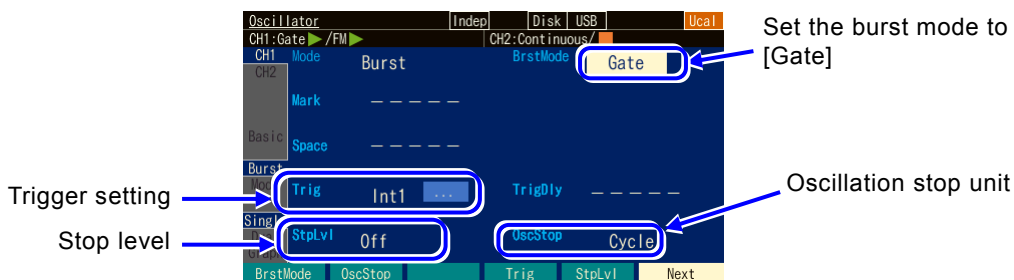

○ Burst mode [BrstMode]

Set the burst mode. Here it is set to gate oscillation [Gate].

○ Oscillation Stop Unit [OscStop]

This is the oscillation stop unit. Select from 1 cycle and half cycle. Usually, set this to 1 cycle.

- Trigger [Trig]

This is the trigger condition (gate condition). Select a trigger source from internal and external.  
☞ P.4-115

- Stop level [StpLvl]

This is the signal level while oscillation is stopped. Set the level by specifying Off or On.  
Usually, this is set to Off ☞ P.4-118

- d) Waveform where gate oscillation is unavailable

Gate oscillation cannot be performed for DC. Gate oscillation can be performed for noise, but the action differs from other waveforms. ☞ P.4-119

- e) Setting items necessary for gate oscillation

Set the oscillation start/stop phase [Phase] on page 1 of the setting screen.

The stop level [StpLvl] on page 2 of the setting screen is usually set to off [Off]. ☞ P.4-118

The oscillation stop unit [OscStop] on page 2 of the setting screen is usually set to 1 cycle [Cycle].  
☞ P.4-118

A trigger (gate) is necessary for gate oscillation. See the next section.

- f) Trigger (gate) setting for gate oscillation

Internal trigger oscillator, external signal, and manual trigger operation can be used as a trigger (gate).

While the gate signal is on, the Triggered lamp on the left of the TRIG key is lit.

Set the trigger source in trigger [Trig] on page 2 of the setting screen. The trigger delay is fixed to the minimum.

- Trigger source setting

A trigger source can be selected from internal [Int]/[Int1]/[Int2] or external [Ext]/[Ext1]/[Ext2].

The trigger cycle of an internal trigger and the polarity/threshold of an external trigger can be set.

When the trigger source is internal [Int]/[Int1]/[Int2], the gate signal is square waves with duty 50%.

The trigger source is common to the synchronization source of the sweep trigger, burst trigger, and synculator.

When a trigger source is external [Ext]/[Ext1]/[Ext2], the polarity of a trigger can be set.

- Manual trigger

Manual trigger operation is effective, regardless of the trigger source setting.

The TRIG key can be used for manual trigger operation.

While the TRIG key is pressed, the gate signal is On. However, in case of the WF1984, the TRIG key works for the channel whose display is active.

For the channel where the display is active, ☞ P.4-23

When only manual trigger operation and remote trigger operation are used for a trigger, we recommend setting the trigger source to external [Ext] and polarity to [Off].

- How to perform gate oscillation with a remote trigger

Gate oscillation cannot be performed directly from external control. This is because the gate signal will conflict with the manual trigger, trigger input, etc.

However, operation equivalent to gate oscillation can be performed by using a trigger burst.

In this case, first set the burst mode [BurstMode] to [Trigger], number of mark waves to [Inf], and trigger delay time to 0 sec.

To turn on the gate signal, issue a trigger command. To turn off the gate signal, issue the “burst oscillation mode selection/query” command or “burst mode selection/query” command.

The difference between them is the phase that is stopped. “Burst oscillation mode selection/query” continues oscillation up until the number of cycle units specified in [OscStop]. “Burst mode selection/query” will stop oscillation immediately.

Remote trigger operation is always effective, regardless of the trigger source setting.

When only manual trigger operation and remote trigger operation are used for a trigger, we recommend setting the trigger source to external [Ext]/[Ext1]/[Ext2] and polarity to [Off].

**g) To start gate oscillation → Trigger (gate signal)**

When gate signal On is accepted, oscillation starts.

Internal trigger oscillator, external signal, manual trigger operation, and remote trigger can be used as a trigger.

**h) To output a burst synchronous signal → Synchronous output setting**

Set this in synchronization/sub output [SubOut] on page 3 of the setting screen.

Selection options vary in the modulation function settings. Select from the following table.

Modulation function is on and internal modulation	Modulation function is off or external modulation
Waveform reference phase synchronization [Sync]	Waveform reference phase synchronization [Sync]
Burst synchronization [BrstSync]	Burst synchronization [BrstSync]
Internal modulation synchronization [ModSync]	-
Internal modulation waveform [ModFctn]	Sub waveform [SubFctn]
Off [Off]	Off [Off]

■ When [Sync] is selected

A signal with TTL level which rises at the reference phase of the waveform is output from the synchronization/sub-output terminal.

- When [BrstSync] is selected

A signal with TTL level which is synchronized with the gate oscillation is output from the synchronization/sub-output terminal. It is low during oscillation, and high while oscillation is stopped, as show in the following figure. Note that it is different from a gate signal.

When a signal under burst is observed with an oscilloscope or similar device, it can be used as a trigger signal of the oscilloscope.

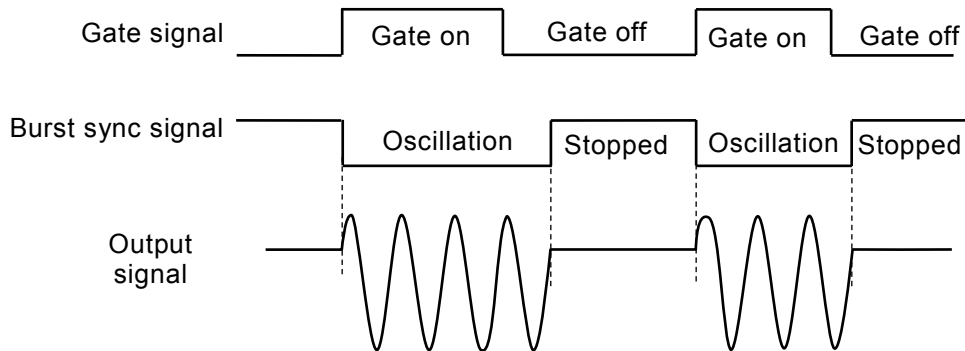

- When [SubFctn] is selected (only when modulation function is off or using external modulation)

The sub waveform is output. The frequency, waveform, amplitude, offset and phase are settable independently from waveform output. For the setting procedure, see P.4-128.

- When [Off] is selected

The output will be at a low level. This helps to reduce interference from a ground common with externally connected devices or from a synchronization output signal.

i) To oscillate in half cycle → Oscillation stop unit as half cycle

When you want to stop oscillation every half cycle, set the oscillation stop unit [OscStop] to half cycle [HalfCycle] on page 2 of the setting screen. Usually, set this to 1 cycle [Cycle]. When it is set to 1 cycle [Cycle], the oscillation has an integer cycle.

The following figure shows the comparison for the cases of one cycle and half cycle. Start oscillation/stop phase: 30 degrees, stop level: In case of Off.

In the case of 1 cycle unit, the oscillation is stopped when the start oscillation/stop phase is reached after the gate turns off.

In the case of a half cycle unit, the oscillation is stopped when the start oscillation/stop phase or the start oscillation/stop phase + 180 degrees (or -180 degrees) is reached after the gate turns off, and then it transitions to the start oscillation/stop phase.

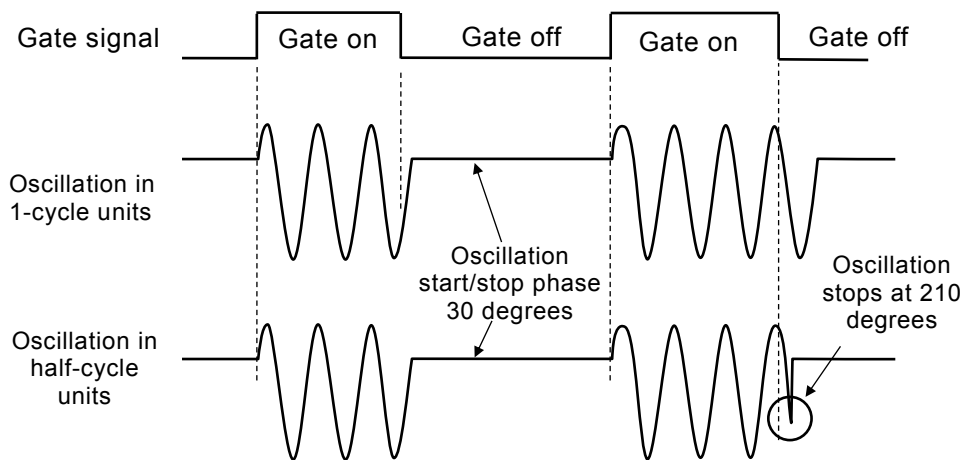

j) How to use stop level

The level while oscillation is stopped is usually set by the oscillation start/stop phase. It is also possible to set it by the ratio to the full scale of the amplitude independently.

Set the stop level [StpLvl] to on [On] on page 2 of the setting screen, and set the level as a % value. P.4-113



### k) Noise gate oscillation

Since noise has no cycle, the gate On zone becomes the oscillation zone directly, and the gate Off zone becomes the oscillation zone directly. In addition, since noise has no phase, a stop level setting is always effective.

The following figure shows an example of noise gate oscillation. This is a case with the stop level of 0%.

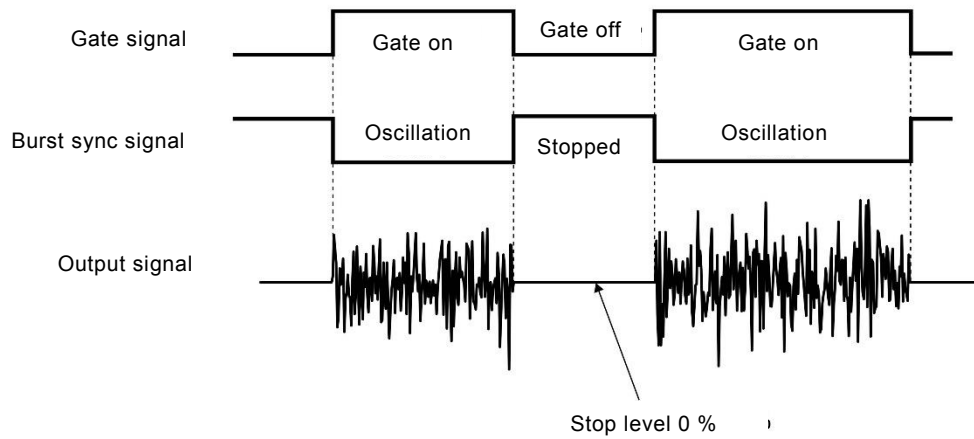

### 4.9.6 Triggered Gate Oscillation

Gate oscillation that turns the gate On/Off every time a trigger is accepted.

#### a) Triggered gate oscillation example

Start oscillation/stop phase: 30 degrees, Oscillation stop unit: 1 cycle, Stop level: In case of Off.  
The oscillation is stopped when the start oscillation/stop phase is reached after the gate signal turns off.

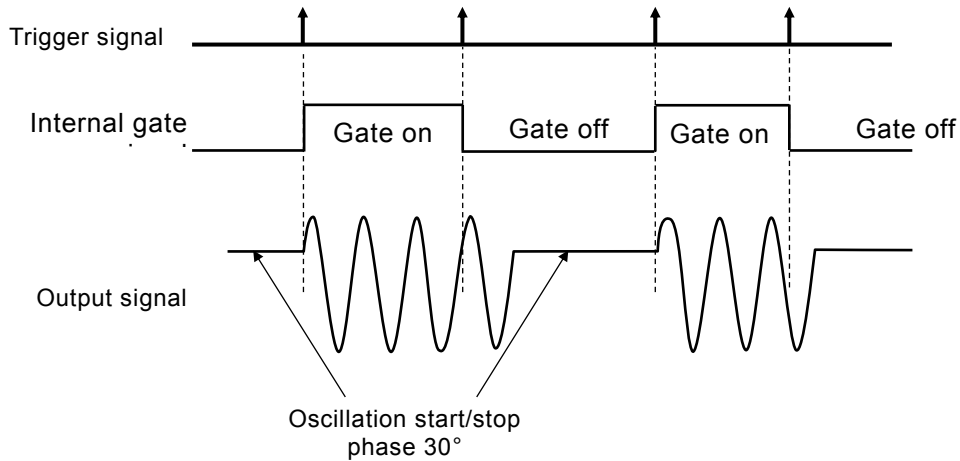

#### b) To set burst mode to triggered gate oscillation

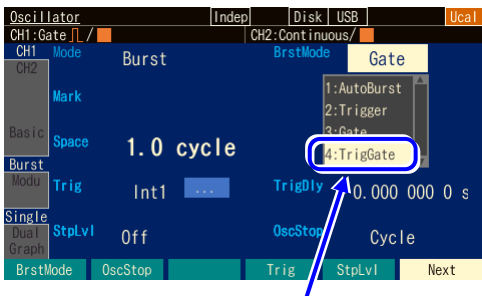

Select [TrigGate] in [BrstMode] and then press the ENTER key.

Select burst mode [BrstMode] on page 3 of the setting screen and then press the ENTER key to display the burst mode selection list. Select triggered gate oscillation [TrigGate] to set the triggered gate oscillation mode.

### c) Screen for triggered gate oscillation setting



**○ Burst mode [BrstMode]**

Set the burst mode. This sets the triggered gate oscillation [TrigGate].

**○ Oscillation Stop Unit [OscStop]**

This is the oscillation stop unit. Select from 1 cycle unit and half cycle unit. Usually, set this to 1 cycle unit. ☞ P.4-124

**○ Trigger [Trig]**

This is the trigger condition.

Select a trigger source from internal and external. ☞ P.4-122

**○ Stop level [StpLvl]**

This is the signal level while oscillation is stopped. Set the level by specifying Off or On.

Usually, set this to Off ☞ P.4-124

### d) Waveform where trigger gate oscillation is unavailable

Triggered gate oscillation cannot be performed for DC.

Triggered gate oscillation can be performed for noise, but the action differs from other waveforms.

☞ P.4-124

### e) Setting items necessary for triggered gate oscillation

Set the oscillation start/stop phase [Phase] on page 1 of the setting screen.

The stop level [StpLvl] on page 2 of the setting screen is usually set to off [Off].

☞ P.4-124

The oscillation stop unit [OscStop] on page 2 of the setting screen is usually set as 1 cycle [Cycle]. ☞ P.4-124

A trigger is necessary for triggered gate oscillation. See the next section.

### f) Trigger setting of triggered gate oscillation

Internal trigger oscillator, external signal, manual trigger key operation, and remote trigger can be used as a trigger.

When a trigger is received, the Triggered lamp on the left of the TRIG key lights up.

Set the trigger source in trigger [Trig] on page 2 of the setting screen. The trigger delay is fixed to the minimum.

#### ■ Trigger source setting

A trigger source can be selected from internal [Int]/[Int1]/[Int2] or external [Ext]/[Ext1]/[Ext2].

The trigger cycle of an internal trigger and the polarity/threshold of an external trigger can be set. The trigger source is common to the synchronization source of the sweep trigger, burst trigger, and synclator.

When a trigger source is external [Ext]/[Ext1]/[Ext2], input a trigger signal with a TTL level to the external trigger input terminal (TRIG IN/#1/#2).

#### ■ How to use manual and remote triggers

Manual trigger operation and remote trigger operation is effective, regardless of the trigger source setting.

The TRIG key can be used for manual trigger operation.

However, in the case of WF1984, the TRIG key only works on the channel side where the display is active. For the channel where the display is active, [P.4-23](#)

When only manual trigger operation and remote trigger operation are used for a trigger, we recommend setting the trigger source to external [Ext], [Ext1], or [Ext2] and polarity to [Off].

### g) To start triggered gate oscillation → Trigger

When the trigger is accepted and the internal gate signal is On, oscillation starts.

Internal trigger oscillator, external signal, manual trigger operation, and remote trigger can be used as a trigger.

**h) To output a burst synchronization signal → Synchronous output setting**

Set this in synchronization output [SubOut] on page 3 of the setting screen. Select from the following table.

Modulation function is on and internal modulation	Modulation function is off or external modulation
Waveform reference phase synchronization [Sync]	Waveform reference phase synchronization [Sync]
Burst synchronization [BrstSync]	Burst synchronization [BrstSync]
Internal modulation synchronization [ModSync]	-
Internal modulation waveform [ModFctn]	Sub waveform [SubFctn]
Off [Off]	Off [Off]

■ When [Sync] is selected

A signal with TTL level which rises at the reference phase of the waveform is output from the synchronization/sub-output terminal.

■ When [BrstSync] is selected

A signal with TTL level which is synchronized with the gate oscillation is output from the synchronization/sub-output terminal. It is low during oscillation, and high while oscillation is stopped, as show in the following figure. Note that it is different from a gate signal.

When a signal under burst is observed with an oscilloscope or similar device, it can be used as a trigger signal of the oscilloscope.

■ When [Off] is selected

The output will be at a low level. This helps to reduce interference from a ground common with externally connected devices or from a synchronization output signal.

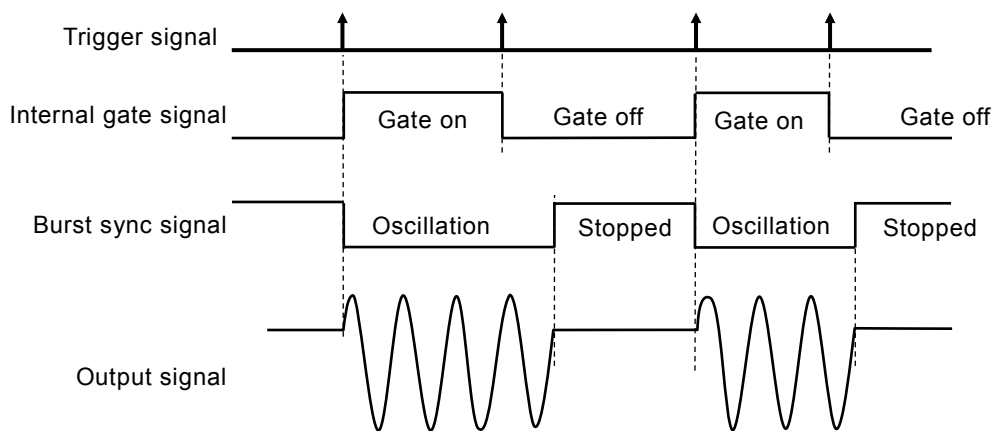

**i) To oscillate in half cycle → Oscillation stop unit as half cycle**

When you want to stop oscillation every half cycle, set the oscillation stop unit [OscStop] to half cycle [HalfCycle] on page 2 of the setting screen. Usually, set this to 1 cycle [Cycle]. When it is set to 1 cycle [Cycle], the oscillation has an integer cycle.

**j) How to use stop level**

The level while oscillation is stopped is usually set by oscillation start/stop phase. It is also possible to set it by the ratio to the full scale of the amplitude independently.

Set the stop level [StpLvl] to on [On] on page 2 of the setting screen, and set the level as a % value.  P.4-113

**k) Triggered gate oscillation of noise**

Since noise has no cycle, the gate On zone is the oscillation zone, and the gate Off zone is the oscillation zone. In addition, since noise has no phase, a stop level setting is always effective.  P.4-119

## 4.10 To Use the Synclator Function

### 4.10.1 Synclator

The function to output a waveform with the same frequency as that of an external input signal is called the synclator function. It is capable of conversion, smoothing, and phase shift of waveforms and frequency division and multiplication ratio of the input frequency.

In addition, it can be combined with the modulation function and auto burst.

### 4.10.2 Operation of Synclator

#### ○ Lock operation

The frequency of the waveform output is forcibly matched to that of the signal input to the external trigger input terminal. If the input of the phase comparator shifts by 90 degrees or more, the frequency is matched again.

The phase is changed discontinuously at this time.

#### ○ Phase difference between input and output

The phases of input and output will not become the same even in the locked state due to the circumstance of internal processing. In addition, the phase difference varies depending on the frequency. To make the phases the same, match them in the phase settings.

#### ○ Display of [Freq] field

If the synclator function is turned on and the input signal is locked, the current oscillator frequency is displayed in the [Freq] field, and the frequency cannot be changed.

If it is not locked, "————" is displayed in the [Freq] field.

#### ○ Response speed

When the division number of the input frequency is 1, switching from the unlocked status to the locked status takes about 50 cycles of the input signal + 40 ms. The time to switch to the locked status increases as the division number increases.

### 4.10.3 Conditions Under Which Synclator Is Available

#### ○ Inputtable frequency range

The range is  $30 \text{ Hz} \times M$  to  $5 \text{ MHz}/N$ .  $M$  is the division number, and  $N$  the multiplication number.

#### ○ Outputtable frequency range

The range is 30 Hz to 5 MHz regardless of the settings for the division number  $M$  and multiplication number  $N$ . However, if the setting range limit value of the frequency is set to within 30 Hz to 5 MHz, oscillation exceeding that range is not possible.

Furthermore, in the case of an arbitrary waveform of array format, the upper frequency is limited to  $240 \text{ MHz} / \text{number of data points}$ . In the case of an arbitrary waveform of control point format, the set range limit value of frequency is the upper limit.

○ Rate of change of frequency of input signal

Locking is not possible for an input signal with which the rate of change of frequency will exceed about 5 kHz/s.

○ Oscillation modes in which can be used

The synclator can be used when modulation except FM /FSK / external PSK and when auto burst or continuous oscillation.

○ Limitations due to channel mode

Use is not possible when the channel mode is constant frequency difference or constant frequency ratio.

○ Waveforms

Use is possible when sine wave, square wave, ramp wave, parameter-variable waveform, and arbitrary waveform. Use is not possible with DC, noise, and pulse.

○ Other limitations

- When the waveform is an arbitrary waveform or parameter-variable waveform, the lock may be disabled if the waveform is rewritten.
- The phase between the input external signal and the signal output to the waveform output will not become zero. In addition, it varies depending on the frequency. (This can be freely set in the phase setting.)
- When the number of waveform points is low and an odd number with an arbitrary waveform, the phase shifts.

Since the minimum odd number for the waveform length is 17 words, that time is the maximum. When the wave length is n (odd number), the phase shift  $\Delta\text{ph}$  is

$$\Delta\text{ph}=180/n[^\circ] \quad \therefore 10.588^\circ @n=17$$

✔ Check

Even if the phase is set to  $0^\circ$ , the phase difference between the added external signal and the output signal will not become  $0^\circ$ . A shift of about  $\pm(1 \text{ degree} + 500 \text{ ns})$  occurs.



### 4.10.4 Setting procedure

a) To turn the synclator on

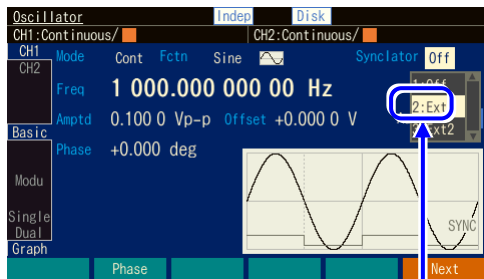

Select Ext/Ext1/Ext2 and then press the ENTER key.

Select the [Synclator] field on the top right of the Basic screen and then press the ENTER key to enable selection of the synchronization source of the synclator.

The WF1983 is fixed to Ext. The WF1984 allows you to select Ext1 or Ext2 independently for each channel.

b) Setting window for synchronization source parameters

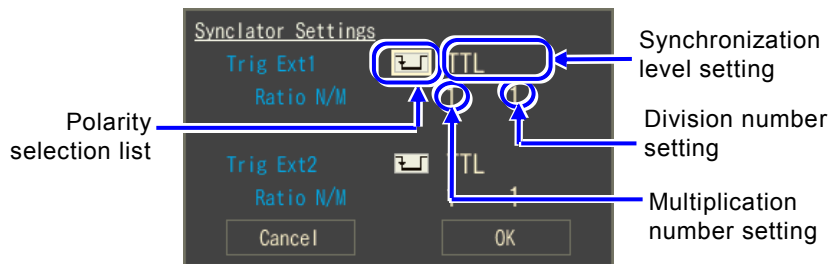

○ Polarity selection

Select the edge polarity of the synchronization source. Select from OFF, leading edge, and trailing edge.

○ Synchronization level

Set the threshold level of the synchronization source. Select from TTL and Variable. When Variable is selected, voltage setting becomes possible, and the range of -5 V to +5 V can be set with a 0.1 V resolution. If Variable is changed, the threshold level takes approximately 800 ms to stabilize.

○ Division number setting [M]

Divides the frequency of the synchronization source. Set this within the range of 1 to 64. If frequency of synchronization source ÷ M falls below 30 Hz, the status becomes unlocked.

○ Multiplication number setting [N]

Set the multiplication number for the frequency of the synchronization source ÷ M. Set this within the range of 1 to 64. If frequency of synchronization source ÷ M x N exceeds 5 MHz, the status becomes unlocked.

## 4.11 Using Sub Waveforms

A waveform that differs from the waveform output that is output from the synchronization/sub-output BNC terminal is called a sub waveform. Although there are limitations compared to waveform output, such as a frequency range of 0 to 5 MHz and output voltage range of -3.3 V to +3.3 V/open, you can use a sub waveform as a two-phase output oscillator with the WF1983 or a maximum four-phase output oscillator with the WF1984.

### 4.11.1 Conditions Under Which Sub Waveforms Are Available

A sub-waveform can be used when the modulation function is turned off or when external modulation.

### 4.11.2 To Set Sub Waveforms

#### a) Selectable waveforms

This can be set in sub-waveform [SubFctn] on page 4 of the Oscillator setting screen.

Select from the following eight options:

- Sine wave [Sine]
- Square wave (duty 50%) [Square]
- Triangle wave (symmetry 50%) [Triangle]
- Up ramp wave [UpRamp]
- Down ramp wave [DnRamp]
- Noise [Noise]
- Arbitrary wave [ARB]
- Parameter-variable waveform [PWF]

#### b) Operation when an arbitrary waveform is selected

When an arbitrary waveform is selected, the [...] button appears. This button will open a screen to select an arbitrary waveform.  P.4-61

The arbitrary waveform data is converted to 4 096 points. For details on arbitrary waveforms, see P.7-2.

#### c) Operation when noise is selected

An item to select the bandwidth is also displayed when noise is selected.

### 4.11.3 To Set the Sub Waveform Frequency

This can be set in sub-waveform frequency [SubFreq] on page 4 of the Oscillator setting screen.

### 4.11.4 To Set the Sub Waveform Phase

Set the phase to add to the reference phase of the sub waveform.

The value set in sub-waveform phase [SubPhs] of [Modu] on page 4 of the Oscillator setting screen is added to the reference phase, and the result is output from the synchronization/sub-output.

### 4.11.5 To Set the Sub Waveform Amplitude

Set the sub waveform amplitude [SubAmp] on page 4 of the Oscillator setting screen.

The maximum total value of AC amplitude and DC offset is restricted to  $\pm 3.3$  V/open.

For example, when the AC amplitude is 1Vp-p/open, DC offset is restricted to the range from -2.8V/open to +2.8V/open.

### 4.11.6 To Set the Sub Waveform DC Offset

Set the sub waveform offset [SubOfs] on page 4 of the Oscillator setting screen.

The setting range will be restricted along with the amplitude. See the previous section.



## 5. Saving and Recalling Settings

- 5.1 Procedure to Save Settings ..... 5-2
- 5.2 Procedure to Recall Settings ..... 5-5
- 5.3 To Rename Setting Memory ..... 5-7
- 5.4 To Return Saved Settings to Initial Settings ..... 5-8
- 5.5 USB Flash Memory Operations ..... 5-8

You can save the current setting condition in the setting memory, and call it to use later.

Settings are saved on the Store Settings screen and recalled on the Recall Settings screen.

When the power is resumed after a power failure, WF1983 or WF1984 will load the contents of the configuration memory 1. P.4-5

Factory defaults are saved in all the setting memories at factory shipment.

## 5.1 Procedure to Save Settings

### 5.1.1 To Save to the Unit's Internal Memory

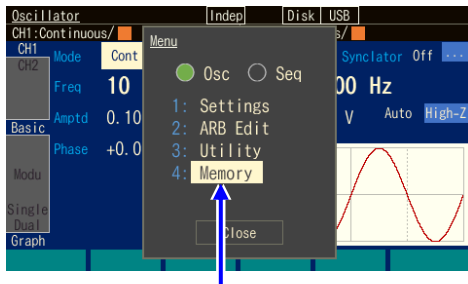

In the top menu, select [Memory]

1. Press the MENU key to open the top menu. Then, select [Memory]. The Memory screen opens.

Select [Internal Memory No.], and then press the ENTER key to open the input field of the setting memory number to which to save.

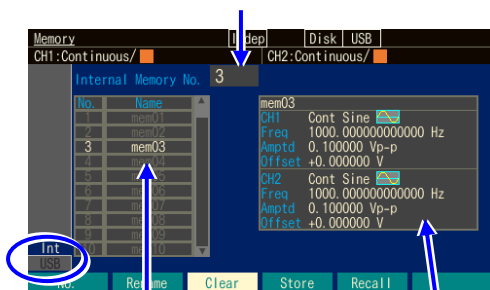

The specified setting memory number and the setting name are highlighted

Select [Int] and then press the ENTER key to save to the unit internal memory

An overview of the settings of the specified setting memory number is displayed

2. To save to the unit's internal memory, select the Int tab at the bottom left of the screen, and then press the ENTER key. Select the [Internal Memory No.] field at the top left of the screen, and then press the ENTER key to open the input field of the setting memory number to which to save.

Use the up/down arrow keys or the modify knob to increment or decrement the setting memory number.

The specified setting memory number and its setting name are highlighted on the left side of the screen.

An overview of the settings saved in the specified setting memory number is displayed on the right side of the screen.

Select the setting memory number to which to save, and then press the ENTER key to close the input field of the setting memory number.

When the [Store] soft key is pressed, the dialog box to confirm the save operation is opened.

Select [OK], and then press the ENTER key to save the settings.



3. Press the [Store] soft key to open the dialog box to confirm the save operation. Select the [Wave] field and then press the ENTER key to open the name input field. Change the name with numeric keypad, up and down arrow keys, or modify knob. To save the settings, select [OK] and then press the ENTER key. Saving is performed and the settings previously saved to the setting memory number are overwritten by the new settings.

### 5.1.2 To save to USB flash memory

The data saved to the unit's internal memory can be copied to USB flash memory.

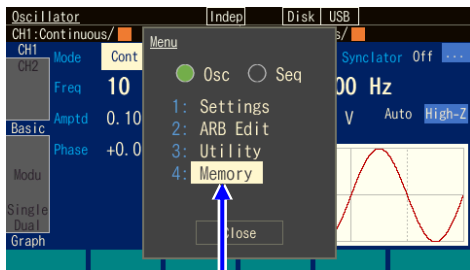

In the top menu, select [Memory]

1. Press the MENU key to open the top menu. Then, select [Memory]. The Memory screen opens.

To save to USB flash memory, select [USB] and then press the ENTER key.

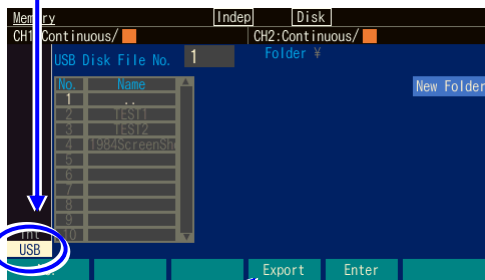

When the [Export] soft key is pressed, the dialog box for saving is displayed.

Select a folder and press the [Enter] soft key to go to that folder.

2. To save to USB flash memory, connect the USB flash memory to the unit and then select the USB tab on the bottom left of the screen and press the ENTER key. Press the [Export] soft key to display the dialog box. Selecting the folder (item with "¥" at the end of the name) and pressing the [Enter] soft key moves to the folder.

## 5.1 Procedure to Save Settings

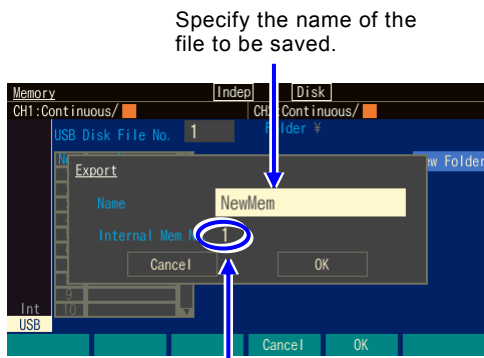

3. Specify the internal memory number of the save source in the [Internal Mem No.] field. Specify the name of the file to save to USB flash memory in the [Name] field. Press the [OK] soft key to start saving. The input field of the setting memory number of the save destination is opened. Use the up/down arrow keys or the modify knob to increment or decrement the setting memory number.

## 5.2 Procedure to Recall Settings

### 5.2.1 To Recall from the Unit's Internal Memory

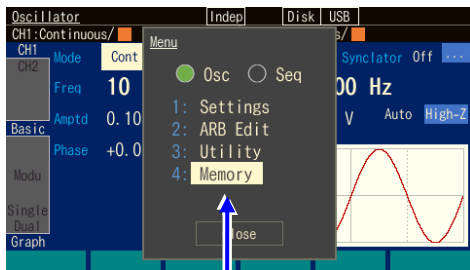

In the top menu, select [Memory]

Select [Internal Memory No.] on the top right of the screen, and then press the ENTER key to open the input field of the memory number.

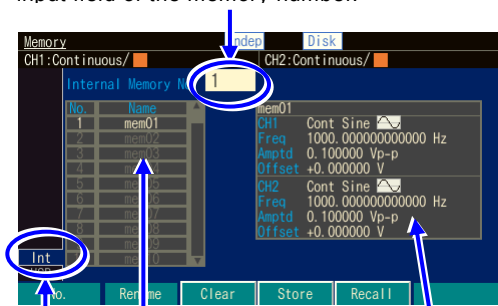

The specified setting memory number and the setting name are highlighted

An overview of the settings of the specified setting memory number is displayed

To load from the unit's internal memory, select [Int] and then press the ENTER key.

1. Press the MENU key to open the top menu. Then, select [Memory]. The Memory screen opens.

2. To load from the unit's internal memory, select the Int tab at the bottom left of the screen and then press the ENTER key. Select the [Internal Memory No.] field at the top left of the screen, and then press the ENTER key to open the input field of the setting memory number from which to recall.

Use the up/down arrow keys or the modify knob to increment or decrement the setting memory number.

The specified setting memory number and its setting name are highlighted on the far left of the screen. An overview of the settings saved to the specified setting memory number is displayed on the right side of the screen.

Select the setting memory number from which to recall, and then press the ENTER key to close the input field of the setting memory number.

3. Press the [Recall] soft key to perform recalling and change the current settings.



5.2.2 To recall from USB flash memory

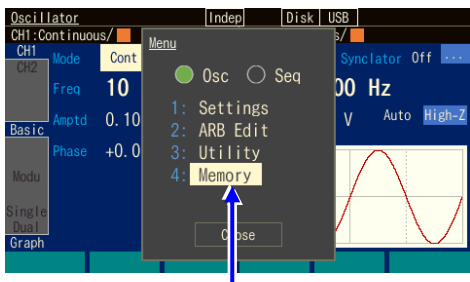

In the top menu, select [Memory]

Select a file in the recall source.

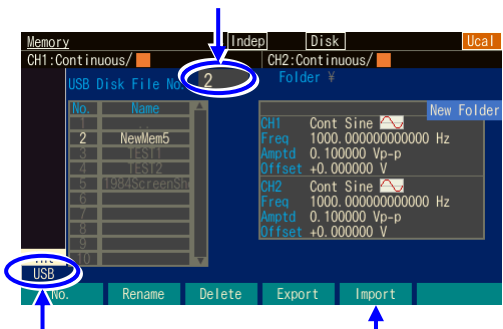

To load from USB flash memory, select [USB] and then press the ENTER key.

Press the [Import] soft key to open the dialog box to select the recall source.

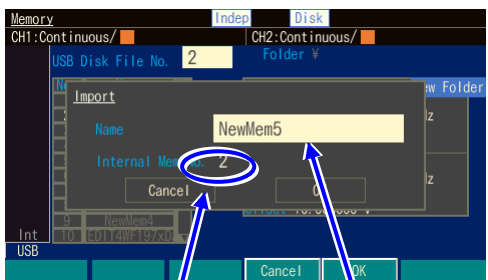

Specify the internal memory number of the recall destination here.

You can also change the setting name.

1. Press the MENU key to open the top menu. Then, select [Memory]. The Memory screen opens.

2. To recall settings saved to USB flash memory, first connect the USB flash memory to the unit, then select the USB tab on the far left of the screen and press the ENTER key. Selecting the folder (item with "¥" at the end of the name) and pressing the Enter soft key moves to the folder. Select a file in the recall source. Press the [Import] soft key to open the dialog box to confirm the recall operation.

3. Specify the internal memory number of the save destination in the [Internal Mem No.] field. To recall the settings, select [OK], and then press the ENTER key. The settings are recalled and the current settings are changed.

## 5.3 To Rename Setting Memory

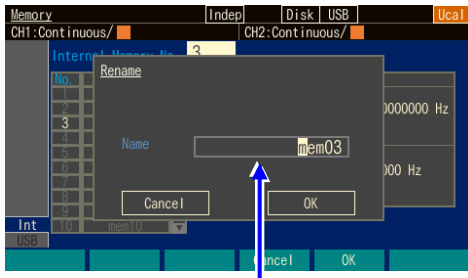

When the [Rename] soft key is pressed, the input field of the setting memory name is opened.

1. As with the save operation, press the [Rename] soft key after setting the setting memory number. The input field of the setting memory name is opened.
2. Select the digit to be changed with the right or left arrow keys, and then use the up or down arrow keys or the modify knob to change the characters. You can enter uppercase and lowercase alphabetic characters, numbers, and symbols. You can directly enter numbers using the numeric keypad. The maximum number of characters for a name is 20.

Press the [Delete] soft key to delete the character at the cursor position and shift the string to the right of the cursor to the left by one character.

Press the [Insert] soft key to insert a space at the cursor position.

Press the [CLR =>] soft key to delete the string on the right of the cursor (excludes the cursor position).

Press the [Clear] soft key to clear all characters.

3. Press the [Apply] soft key or the ENTER key to confirm the changed name and close the input field of the setting memory name.  
Press the CANCEL key to leave the name as it is and close the input field of the setting memory name.

### ✓ Check

You can use the following characters for a setting memory name:

A B C D E F G H I J K L M N O P Q R S T U V W X Y Z

a b c d e f g h i j k l m n o p q r s t u v w x y z

0 1 2 3 4 5 6 7 8 9

! # \$ % & ' ( ) \* + , - . / : ; < = > ? @ [ \ ^ \_ ` { | } ~

Space

The following characters cannot be used when saving to USB flash memory:

\* / : < > ? \ |

## 5.4 To Return Saved Settings to Initial Settings

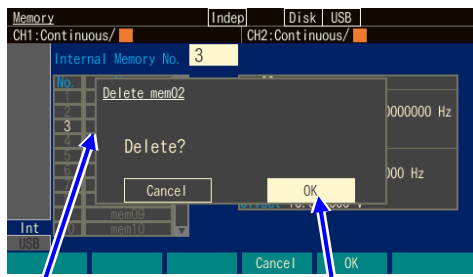

Press the [Clear] soft key to open the dialog box to confirm the initialization operation.

Select [OK] and then press the ENTER key to restore the initial settings.

As with the save operation, press the [Clear] soft key after setting the setting memory number. The dialog box to confirm the initialization operation is opened.

To initialize the settings, select [OK], and then press the ENTER key. The settings saved previously to the setting memory number are overwritten by the initial settings.

A setting files cannot be run from USB flash memory.

## 5.5 USB Flash Memory Operations

This section explains the operations specific to working with USB flash memory.

### 5.5.1 File List

When USB flash memory is the operation target in the operation screen for storing/recalling the settings, arbitrary waveform, or sequence, a list of files in the current folder appears. Any folders directly above the current location are indicated by "..¥" and any folders below the current location are listed. In addition, unrelated files (that are not setting files for the instrument) are not displayed.

Folders above the current location are indicated by "..¥".

Folders below the current location have "/" displayed at the end.

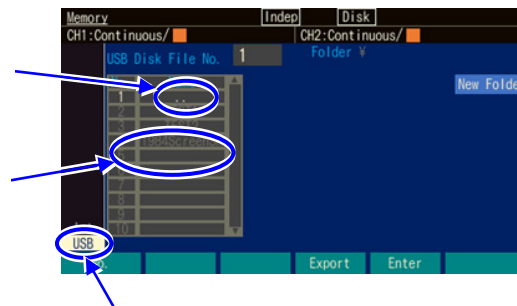

This screen is displayed when the USB tab is selected.

#### Check

If there are too many files and folders in one folder, all of the files and folders will become unable to be displayed and selected. In such a case, delete the folders and files that will not be used.

File and folder names cannot be displayed if they contain double-byte characters such as kanji. Characters that cannot be displayed are converted and displayed as the '?' character.

### 5.5.2 To Change the Current Folder

When working with USB flash memory, the saving or recall of settings applies to the files in the current folder.

**a) To move to the folder directly above**

Select ".." in the file list and press the [Enter] soft key.

**b) To move to a folder directly below**

Select the name of the folder you wish to move to from the file list and press the [Enter] soft key.

### 5.5.3 To Create a Folder

A [NewFolder] button will appear on the Store Settings screen for USB flash memory. Select this button and press the ENTER key to display a dialog box for entering the name of the folder to be created. Enter the name and press [OK] soft key to create the new folder below the current folder and display it in the file list.

### 5.5.4 To Delete a Folder

In the same way as for general files, select the folder that you wish to delete and press the [Delete] soft key to display the confirmation dialog box. Press the [OK] soft key to delete the folder. However, an error will occur if that folder is not empty.

### 5.5.5 File Time Stamps

This instrument does not have a built-in battery. Therefore, the time of the time stamp is off from the actual date and time by the amount of time that the instrument was not energized. The time stamp of a file created is the result of adding the amount of time that the instrument was energized to the date and time that the instrument made the adjustments. The date and time for the time stamp cannot be changed.

MEMO



## **6. Parameter-variable Waveforms**

6.1 Meaning of Each Parameter and Waveform Examples ..... 6-2

## 6.1 Meaning of Each Parameter and Waveform Examples

With respect to complicated waveforms such as those that cannot be created unless they are arbitrary waveforms, any waveform with variables (parameters) that can be changed easily is called a parameter-variable waveform.

The waveform to output can be selected on the parameter-variable waveform selection screen (P.4-59).

With the exception of some names, each of the waveform and parameter names are defined uniquely in this product.

The waveforms are categorized into the following six groups for the sake of convenience.

■ **Steady Sine Group**

Waveform created based on a sine wave. Intended for repeated output.

■ **Transient Sine Group**

Waveform created based on a sine wave. Intended for use as one cycle of the start or end of a continuous sine wave in a sequence oscillation.

■ **Pulse Group**

Pulse shaped waveforms.

■ **Transient Response Group**

Waveform which simulates a system's transient response.

■ **Surge Group**

Waveform which simulates a surge signal.

■ **Others Group**

Waveforms which do not belong to the groups above.

 **Check**

If the frequency or phase is changed, oscillation will be resumed from the set phase. Please note that the phase will become discontinuous.

If a parameter is changed, unexpected output may occur during the waveform.

### 6.1.1 Overview

The following provides an overview, explains the meaning of each parameter, and gives examples for each waveform.

The waveform examples display one cycle of the waveform drawn in the waveform memory. The polarity of the waveform is normal. Since the amplitude range differs depending on the waveform, the amplitude range thought to be typical for the corresponding waveform is set (initial setting value).

The vertical axis  $\pm 1$  corresponds to the waveform memory's full-scale amplitude  $\pm FS$ .

The horizontal axis is the time axis and represents the time for one cycle with a 1. The horizontal axis also represents the phase axis from 0 to 360°. The time for one period is called the "basic cycle" and the inverse is the "fundamental frequency". Each of these is also the respective oscillation cycle and the oscillation frequency of the entire waveform.

#### Check

The AC component of the waveform may disappear depending on the parameter settings.

Press the [Reset] soft key in the center if it is unclear how to restore the settings. This returns each parameter to the default factory setting.

The polarity and amplitude range are not changed.

### 6.1.2 Steady Sine Group

#### a) Unbalanced sine wave (Unbalanced Sine)

##### ■ Overview

Waveform for which the amplitudes of the first half and second half of the sine wave can be changed independently.

##### ■ Application examples

- Simulation of an output waveform where the gain of the plus side differs from the minus side
- Simulation of full-wave rectification and half-wave rectification waveforms



■ Meaning of each parameter

The example shows the case where the amplitude range is  $\pm FS$ .

- First half amplitude (Amptd1)

The amplitude of the first half cycle.

When it is 100%, the amplitude is the same as the original sine wave.

Variable range: -100.00% to 100.00%

- Second half amplitude (Amptd2)

The amplitude of the second half cycle.

When it is 100%, the amplitude is the same as the original sine wave.

Variable range: -100.00% to 100.00%

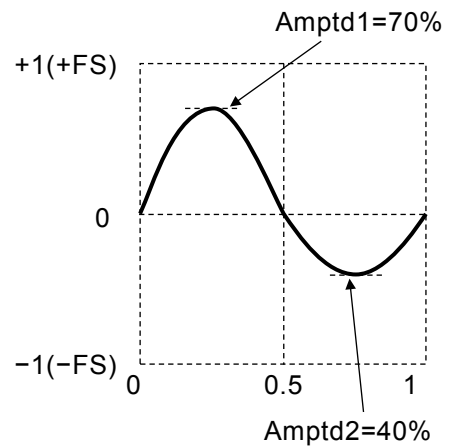

Please note that when changing each of the amplitudes, the upper and lower peak values for the waveform will change.

Also, when the amplitudes of the first and second halves differ, the average value for one cycle will not be zero. Please note that this will generate a DC portion.

■ Waveform examples

The polarity and amplitude ranges are all Normal and  $\pm FS$ .

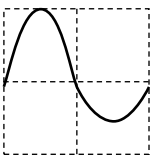
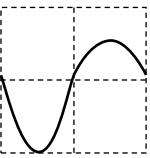
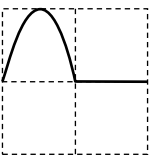
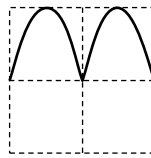
			
Amptd1=100 Amptd2=50	Amptd1=-50 Amptd2=-100	Amptd1=100 Amptd2=0	Amptd1=100 Amptd2=-100

b) Clipped sine wave (Clipped Sine)

■ Overview

Waveform acquired by clipping the top and bottom of the amplitude of a sine wave

■ Application examples

- Simulates a waveform clipped by an input clamp circuit
- Simulates an amp output waveform saturated by the power supply voltage

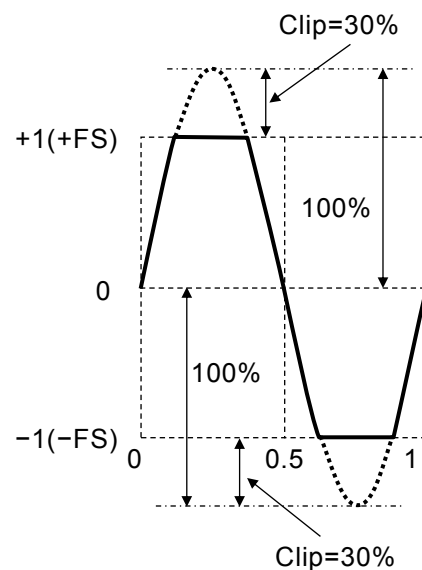

■ Meaning of each parameter

The example shows the case where the amplitude range is  $\pm FS$ .

• Clip ratio (Clip)

The ratio by which the top and bottom of the original sine wave is clipped.

The peak value of the original sine wave is 100%.

The original sine wave corresponds to the 0% value.

Variable range: 0.00% to 99.99%

Peak value is fixed to  $\pm FS$ .

■ Waveform examples

The polarity and amplitude ranges are all Normal and  $\pm FS$ .

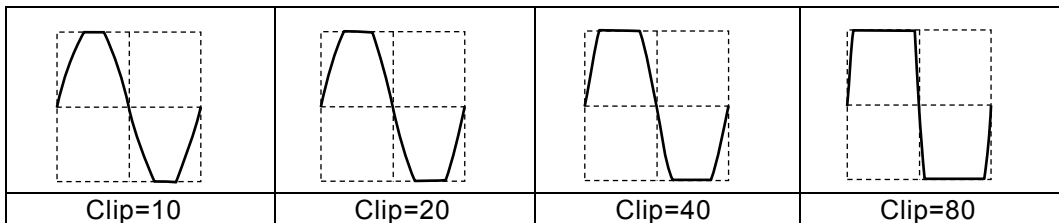

c) CF controlled sine wave (CF Ctrl Sine)

■ Overview

Waveform acquired by extracting only the neighborhood of 90° and 270° of a sine wave and expanding the amplitude.

■ Application examples

- Simulates the current waveform of a condenser input rectifier circuit

■ Meaning of each parameter

The example shows the case where the amplitude range is  $\pm FS$ .

• Crest factor (CF)

The crest factor expresses the ratio of the peak value to the effective value. At a value of 1.41, it is almost equal to the original sine wave.

Variable range: 1.41 to 10.00

Peak value is fixed to  $\pm FS$ .

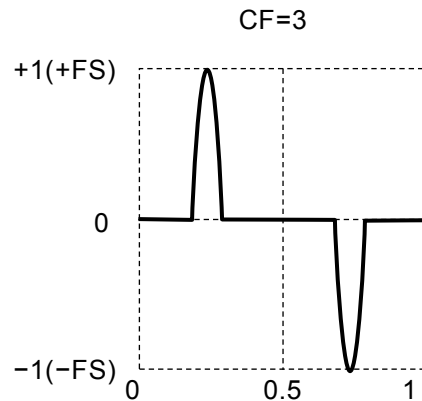

■ Waveform examples

The polarity and amplitude ranges are all Normal and  $\pm FS$ .

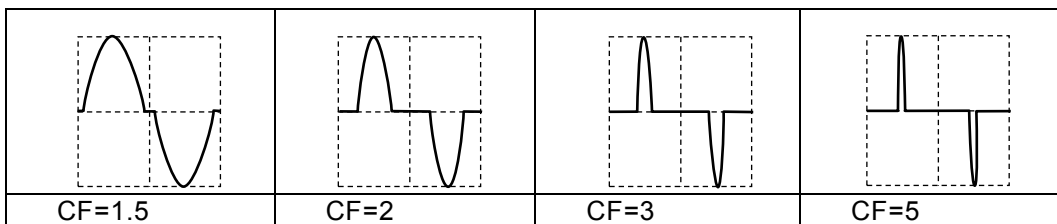

d) Angle controlled sine wave (Angle Ctrl Sine)

■ Overview

Waveform acquired by extracting only the front or back portion of each half cycle of a sine wave.

■ Application examples

- Simulates a thyristor-controlled waveform

■ Meaning of each parameter

The example shows the case where the amplitude range is  $\pm FS$ .

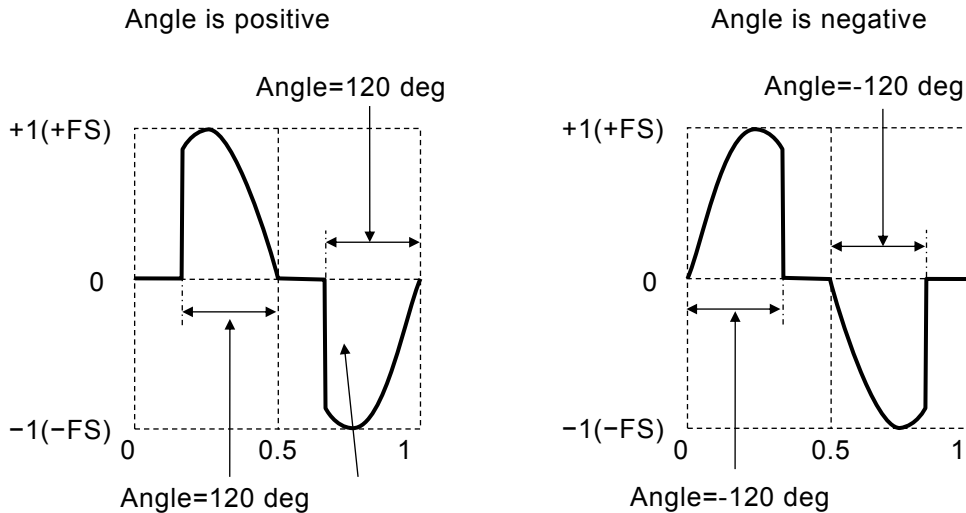

• Conduction angle (Angle)

When the conduction angle is positive, the waveform is a sine wave with the conduction angle portion extracted from the back portion of the half cycle.

When the conduction angle is negative, the waveform is a sine wave with the absolute value portion of the conduction angle extracted from the front portion of the half cycle.

Variable range:  $-180.00^\circ$  to  $180.00^\circ$

The amplitude of the original sine wave is fixed to  $\pm FS$ . Please note that the amplitude may be less than  $\pm FS$  depending on the value of the conduction angle.

■ Waveform examples

The polarity and amplitude ranges are all Normal and  $\pm FS$ .

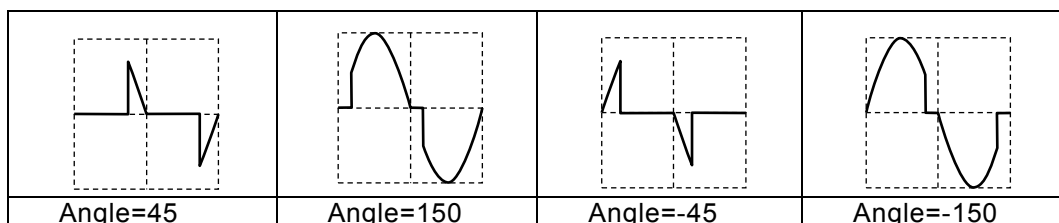

e) Staircase sine wave (Staircase Sine)

■ Overview

This is a staircase shaped sine wave. The horizontal axis and vertical axis are divided at an equal interval.

■ Application examples

- Simulates the pseudo sine wave output waveform of an uninterruptible power supply (UPS), etc.
- Simulates a sine wave converted from analog to digital with a rough voltage and time resolution.

■ Meaning of each parameter

The example shows the case where the amplitude range is  $\pm FS$ .

• X steps ( $N_x$ )

The number of steps. The example on the right is a pseudo sine wave with 12 steps.

Variable range: 2 to 1024, Inf

• Y steps ( $N_y$ )

The number of steps. The example on the right is a pseudo sine wave with 6 steps.

Variable range: 2 to 256, Inf

Peak value is fixed to  $\pm FS$ .

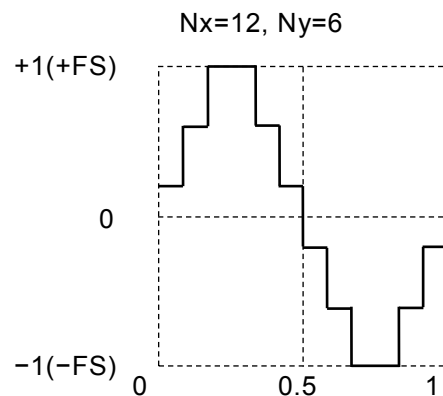

■ Waveform examples

The polarity and amplitude ranges are all Normal and  $\pm FS$ .

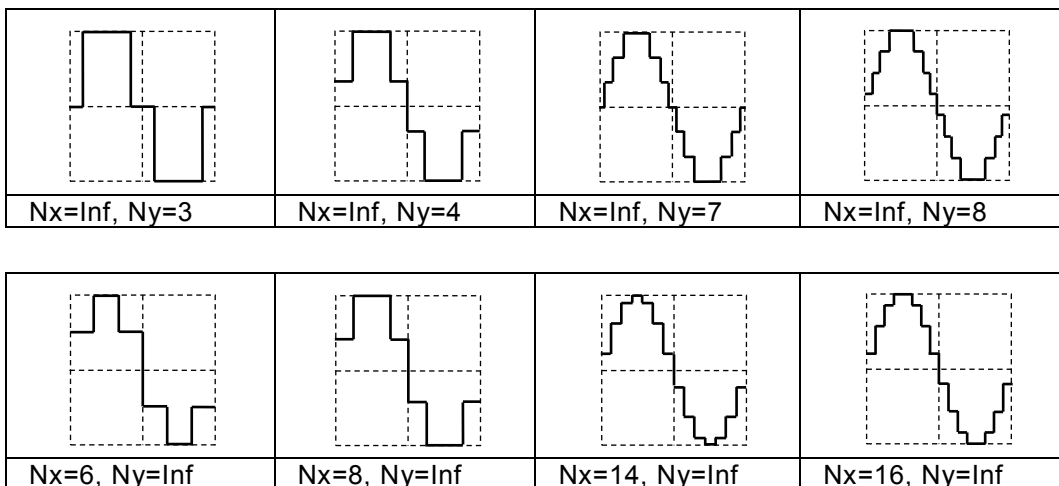

f) Multi-cycle sine wave (Multi-Cycle Sine)

■ Overview

Waveform acquired by continuing the sine wave for multiple cycles.

■ Application examples

- Burst wave substitution

■ Meaning of each parameter

The example shows the case where the amplitude range is  $\pm FS$ .

• Cycles

The number of cycles included in one basic cycle.

Variable range: 0.01 to 50.00

• Start Phase (Phase)

The phase of the start point.

The phase in the frequency of the above cycle multiple of the fundamental frequency.

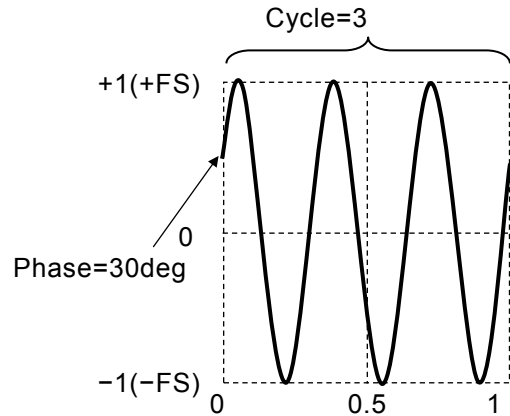

Variable range:  $-360.00^\circ$  to  $360.00^\circ$

Peak value is fixed to  $\pm FS$ .

■ Waveform examples

The polarity and amplitude ranges are all Normal and  $\pm FS$ .

Cycle=3 Phase=0	Cycle=2.5 Phase=0	Cycle=3 Phase=-90	Cycle=2.5 Phase=-90

6.1.3 Transient Sine Group

a) On-phase controlled sine wave (On-Ph Ctrl Sine)

■ Application examples

Sine wave with a slope into the on state.

Application examples

- Simulates the output waveform of an AC power supply with a restricted rising and falling time

■ Meaning of each parameter

The example shows the case where the amplitude range is  $\pm 1(+FS)$  to  $-1(-FS)$ .

- Phase at start completion (OnPhase)

The original sine wave starts from this phase.

Variable range:  $0.00^\circ$  to  $360.00^\circ$

- Starting slope time (SlopeT)

The linear change in time of the amplitude from the zero to the amplitude at the start completion phase.

Variable range:  $0.00\%$  to  $50.00\%$  of basic cycle

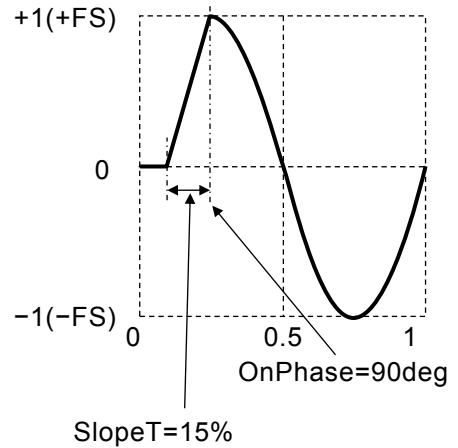

The amplitude of the original sine wave is fixed to  $\pm FS$ .

Please note that the amplitude may be less than  $\pm FS$  depending on the value of the start completion phase.

■ Waveform examples

The polarity and amplitude ranges are all Normal and  $\pm FS$ .

OnPhase=90 SlopeT=10	OnPhase=120 SlopeT=20	OnPhase=150 SlopeT=20	OnPhase=270 SlopeT=10

**b) Off-phase controlled sine wave (Off-Ph Ctrl Sine)**

■ Overview

Sine wave with a slope into the off state.

■ Application examples

- Simulates the output waveform of an AC power supply with a restricted rising and falling time

■ Meaning of each parameter

The example shows the case where the amplitude range is  $\pm FS$ .

• Shut off start phase (OffPhase)

The original sine wave ends at this phase.

Variable range:  $0.00^\circ$  to  $360.00^\circ$

• Shut off slope time (SlopeT)

The linear change in time of the amplitude from the amplitude of the shutdown start phase to the zero.

Variable range:  $0.00\%$  to  $50.00\%$  of basic cycle

The amplitude of the original sine wave is fixed to  $\pm FS$ .

Please note that the amplitude may be less than  $\pm FS$

depending on the value of the shutdown start phase.

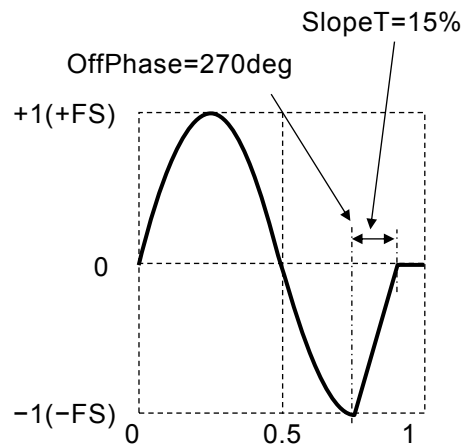

■ Waveform examples

The polarity and amplitude ranges are all Normal and  $\pm FS$ .

OffPhase=90 SlopeT=10	OffPhase=210 SlopeT=20	OffPhase=240 SlopeT=20	OffPhase=270 SlopeT=10



c) Chattering-on sine wave (Chattering-On Sine)

■ Overview

Sine wave with chattering into the on state.

■ Application examples

- Simulates an AC power supply output waveform which follows the chattering pattern of a switch or relay during the start of output.

■ Meaning of each parameter

The example shows the case where the amplitude range is  $\pm FS$ .

• On start phase (OnPhase)

The sine wave starts from this phase.

It is fixed to zero before that.

Variable range:  $0.00^\circ$  to  $360.00^\circ$

• Number of chattering (ChatterN)

The number of times it repeatedly turns on and off.

This is on at first. The repeated on and off portions have the same time duration.

Variable range: 0 to 20

• Time On (Ton)

The amount of time one chatter is turned on.

Variable range: 0.00% to 20.00% of basic cycle

• Time Off (Toff)

The amount of time one chatter is turned off.

Variable range: 0.00% to 20.00% of basic cycle

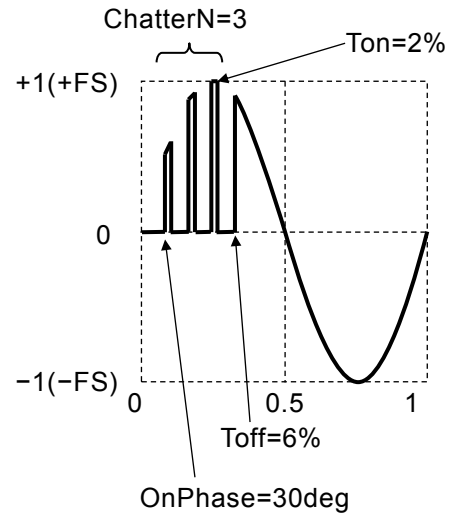

The amplitude of the original sine wave is fixed to  $\pm FS$ . Please note that the amplitude may be less than  $\pm FS$  depending on each parameter setting.

■ Waveform examples

The polarity and amplitude ranges are all Normal and  $\pm FS$

OnPhase=30 ChatterN=0 Ton=2 Toff=6	OnPhase=30 ChatterN=1 Ton=2 Toff=6	OnPhase=30 ChatterN=2 Ton=2 Toff=6	OnPhase=30 ChatterN=3 Ton=2 Toff=6

d) Chattering-off sine wave (Chattering-Off Sine)

■ Overview

Sine wave with chattering into the off state.

■ Application examples

- Simulates an AC power supply output waveform which follows the chattering pattern of a switch or relay during output shut off.

■ Meaning of each parameter

The example shows the case where the amplitude range is  $\pm FS$ .

- Shut off start phase (OffPhase)

The original sine wave begins to follow a chattering pattern from this phase as it shuts off.

Variable range:  $0.00^\circ$  to  $360.00^\circ$

- Number of chattering (ChatterN)

The number of times it repeatedly turns off and on.

This is off at first.

The repeated on and off portions have the same time duration.

Variable range: 0 to 20

- Time On (Ton)

The amount of time one chatter is turned on.

Variable range: 0.00% to 20.00% of basic cycle

- Time Off (Toff)

The amount of time one chatter is turned off.

Variable range: 0.00% to 20.00% of basic cycle

The amplitude of the original sine wave is fixed to  $\pm FS$ .

Please note that the amplitude may be less than  $\pm FS$

depending on each parameter setting.

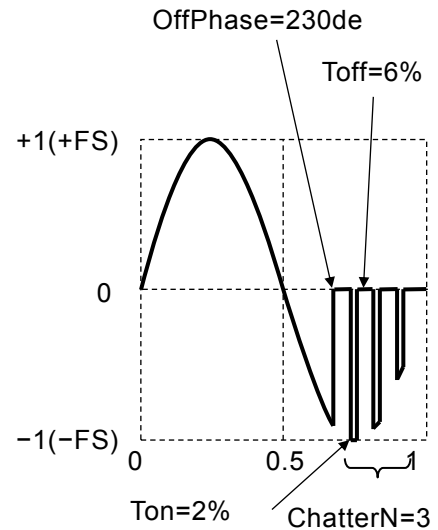

■ Waveform examples

The polarity and amplitude ranges are all Normal and  $\pm FS$ .

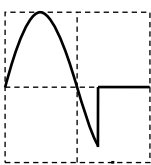
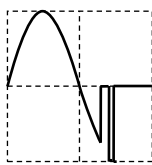
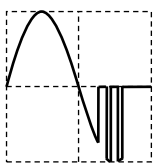
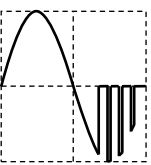
			
OffPhase=230 ChatterN=0 Ton=2 Toff=6	OffPhase=230 ChatterN=1 Ton=2 Toff=6	OffPhase=230 ChatterN=2 Ton=2 Toff=6	OffPhase=230 ChatterN=3 Ton=2 Toff=6

6.1.4 Pulse Group

a) Gaussian pulse

■ Overview

Waveform with a Gaussian distribution.

■ Meaning of each parameter

The example shows the case where the amplitude range is 0/+FS.

- Standard deviation (Sigma)

This is  $\sigma$  of the Gaussian function.

Variable range: 0.01% to 100.00% of basic cycle

Peak value is fixed to +FS at the center of the horizontal axis.

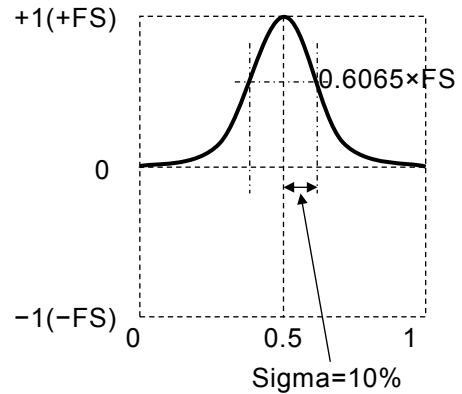

■ Waveform examples

The polarity and amplitude ranges are all Normal and 0/+FS.

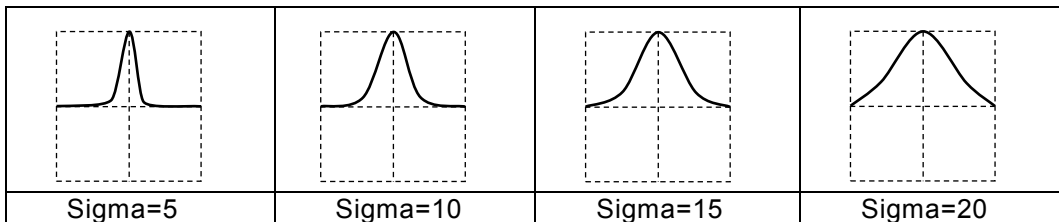

■ Remarks

The half value width is  $2 \cdot \text{Sigma} \cdot \sqrt{2 \cdot \ln(2)} \approx 2.35 \cdot \text{Sigma}$  (%).

The following formula expresses x as the horizontal axis and y as the vertical axis (when the amplitude range is 0/+FS).

$$y = FS \cdot \exp\left(-\frac{1}{2} \left(\frac{100}{\text{Sigma}} (x - 0.5)\right)^2\right)$$

At the start (x=0) and end (x=1), the y value does not decrease all the way down to zero.

Please note that the greater the standard deviation, the higher the start and end will rise above the zero level.

When sigma is 16.47% or lower, the start and end will be 0.01•FS or lower.

**b) Lorentz pulse**

■ Overview

Lorentz waveform.

■ Meaning of each parameter

The example shows the case where the amplitude range is 0/+FS.

• Half width

The half value width of the Lorentz function.

Variable range: 0.01% to 100.00% of basic cycle

Peak value is fixed to +FS at the center of the horizontal axis.

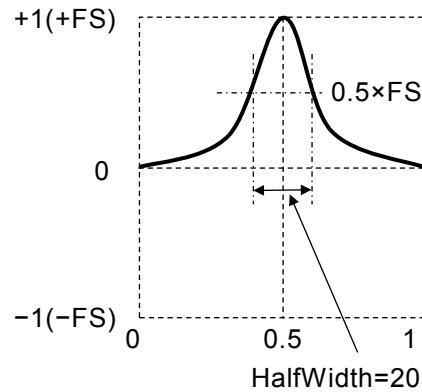

■ Waveform examples

The polarity and amplitude ranges are all Normal and 0/+FS.

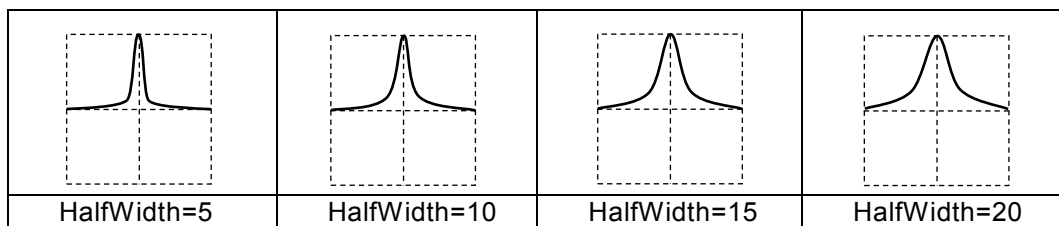

■ Remarks

The following formula expresses x as the horizontal axis and y as the vertical axis (when the amplitude range is 0/+FS).

$$y = FS \frac{1}{1 + \left( \frac{200}{HalfWidth} (x - 0.5) \right)^2}$$

At the start (x=0) and end (x=1), the y value does not decrease all the way down to zero.

Please note that the greater the half value width, the higher the start and end will rise above the zero level. When the half value width is 10.05% or lower, the start will be 0.01•FS or lower.

c) Haversine

■ Overview

$\sin^2$  pulse. This is similar to a waveform of a sine wave from the  $-90^\circ$  to  $270^\circ$  range.

■ Application examples

- Simulates an impact test device waveform

■ Meaning of each parameter

The example shows the case where the amplitude range is  $0/+FS$ .

• Width

The width of one cycle of the  $\sin^2$  pulse.

Other ranges are fixed to the zero level.

Variable range: 0.01% to 100.00% of basic cycle

Peak value is fixed to  $+FS$  at the center of the horizontal axis.

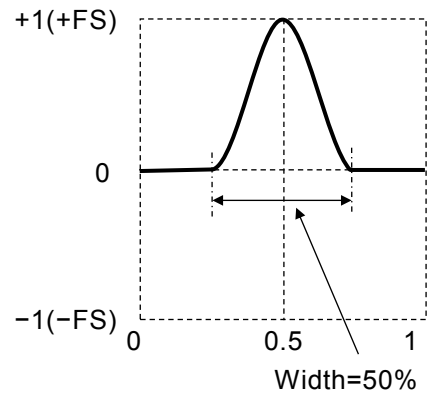

■ Waveform examples

The polarity and amplitude ranges are all Normal and  $0/+FS$ .

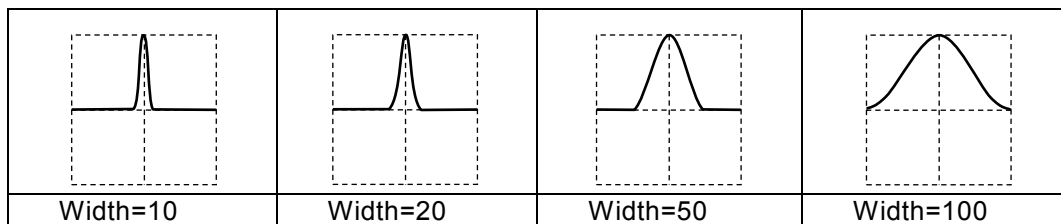

■ Remarks

The half value width is  $Width/2$  (%).

The following formula expresses  $x$  as the horizontal axis and  $y$  as the vertical axis (when the amplitude range is  $0/+FS$ ).

In the range where  $x$  is  $0.5 \pm \frac{Width}{200}$

$$y = \frac{FS}{2} \left( 1 + \cos \left( 2\pi \frac{100}{Width} (x - 0.5) \right) \right)$$

d) Half-sine pulse

■ Overview

Sine wave half cycle pulse. A half cycle waveform of a sine wave from the 0° to 180° range.

■ Meaning of each parameter

The example shows the case where the amplitude range is 0/+FS.

• Width

The width of a sine wave from the 0° to 180° range.

Other ranges are fixed to the zero level.

Variable range: 0.01% to 100.00% of basic cycle

Peak value is fixed to +FS at the center of the horizontal axis.

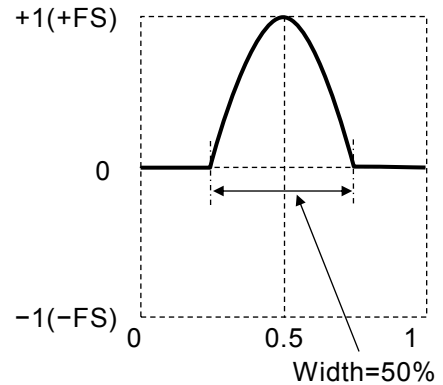

■ Waveform examples

The polarity and amplitude ranges are all Normal and 0/+FS.

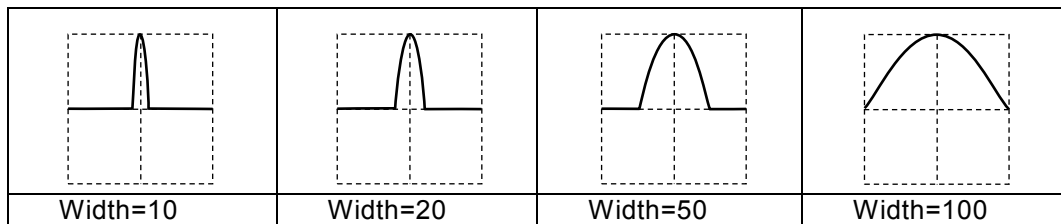

■ Remarks

The half value width is  $2 \cdot \text{Width} / 3$  (%).

The following formula expresses x as the horizontal axis and y as the vertical axis (when the amplitude range is 0/+FS).

In the range where x is  $0.5 \pm \frac{\text{Width}}{200}$

$$y = FS \cdot \cos\left(\pi \frac{100}{\text{Width}} (x - 0.5)\right)$$

e) Trapezoid pulse

■ Overview

Trapezoid waveform pulse.

■ Meaning of each parameter

The example shows the case where the amplitude range is  $0/+FS$ .

- Slope width (RiseFall)

The width of each oblique side.

Variable range: 0.00% to 50.00% of basic cycle

- Upper base width (UpperBase)

The width of the upper base.

Variable range: 0.00% to 100.00% of basic cycle

The peak value is fixed to  $+FS$  at the upper base.

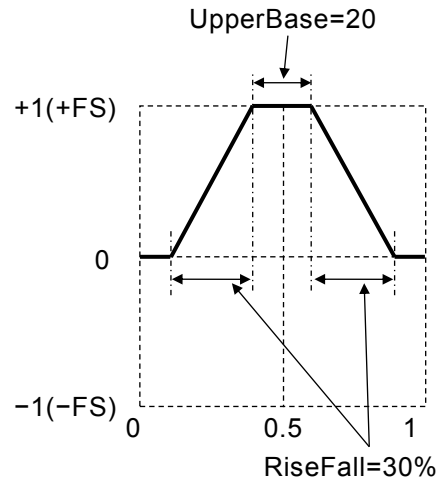

■ Waveform examples

The polarity and amplitude range are all Normal and  $0/+FS$ .

RiseFall=25 UpperBase=50	RiseFall=20 UpperBase=20	RiseFall=0 UpperBase=20	RiseFall=20 UpperBase=0

■ Remarks

Please note that the start ( $x=0$ ) and end ( $x=1$ ) will be greater than zero when the sum of double the slope width and the upper base width exceeds 100%.

f)  $\text{Sin}(x)/x$

■ Overview

$\text{Sin}(x)/x$  waveform. This is called the sinc function.

■ Meaning of each parameter

The example shows the case where the amplitude range is  $\pm\text{FS}$ .

- Number of zero crossings (*ZeroCross*)

The number of zero crossings on one side.

Variable range: 1 to 50

Peak value is fixed to  $+\text{FS}$  at the center of the horizontal axis.

Has a frequency band that is roughly fundamental frequency times number of zero crossings.

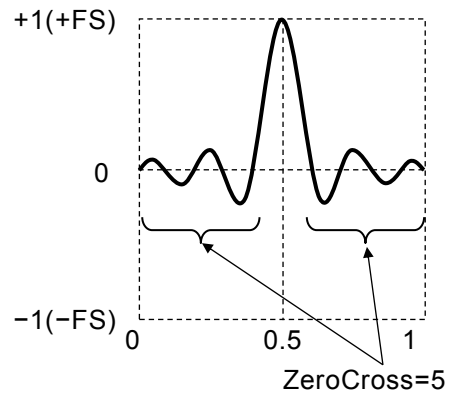

■ Waveform examples

The polarity and amplitude ranges are all Normal and  $\pm\text{FS}$ .

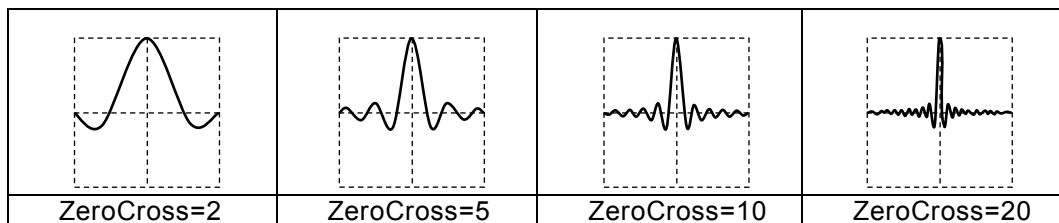

■ Remarks

The following formula expresses  $x$  as the horizontal axis and  $y$  as the vertical axis (when the amplitude range is  $\pm\text{FS}$ ).

$$y = \text{FS} \cdot \frac{\sin(2\pi \cdot \text{ZeroCross} \cdot (x - 0.5))}{2\pi \cdot \text{ZeroCross} \cdot (x - 0.5)}$$



6.1.5 Transient Response Group

a) Exponential rise

■ Overview

First order LPF step response waveform.

■ Application examples

- Simulates a first order lag system's step output waveform

■ Meaning of each parameter

The example shows the case where the amplitude range is 0/+FS.

- Time constant (TC)

Time constant of the exponential function.

Variable range: 0.01% to 100.00% of basic cycle

The amplitude at infinite time is +FS.

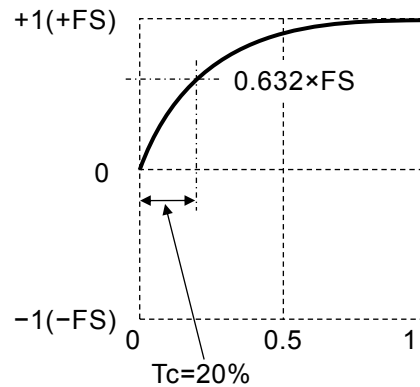

■ Waveform examples

The polarity and amplitude range are all Normal and 0/+FS.

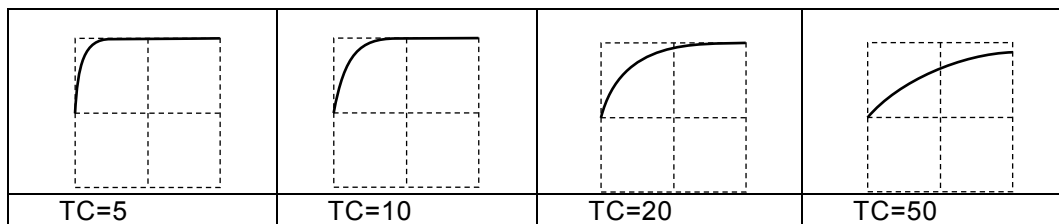

■ Remarks

The following formula expresses x as the horizontal axis and y as the vertical axis (when the amplitude range is 0/+FS).

$$y = FS \cdot \left( 1 - \exp\left(-\frac{100}{TC} x\right) \right)$$

The end (x=1) does not rise up to +FS. Please note that the larger the time constant, the smaller the end value. When the time constant is 21.71% or lower, the end will be 0.99•FS or more.

**b) Exponential fall**

■ Overview

First order HPF step response waveform.

■ Application examples

- Simulates a first order system's step output waveform

■ Meaning of each parameter

The example shows the case where the amplitude range is 0/+FS.

- Time constant (TC)

Time constant of the exponential function.

Variable range: 0.01% to 100.00% of basic cycle

The start begins from +FS.

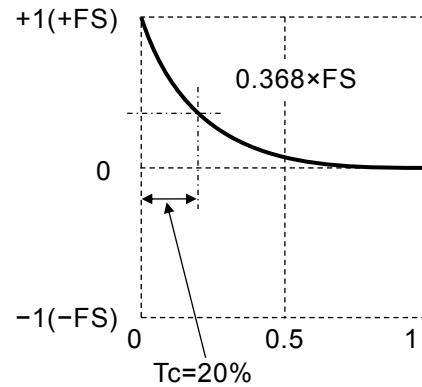

■ Waveform examples

The polarity and amplitude ranges are all Normal and 0/+FS.

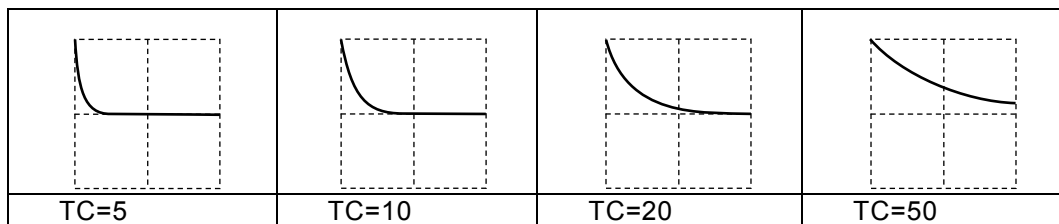

■ Remarks

The following formula expresses x as the horizontal axis and y as the vertical axis (when the amplitude range is 0/+FS).

$$y = FS \cdot \exp\left(-\frac{100}{TC} x\right)$$

The end (x=1) does not decrease all the way down to zero. Please note that the larger the time constant, the larger the end offset. When the time constant is 21.71% or lower, the end will be 0.01•FS or lower.

c) Second order LPF step response (2nd Ord LPF Step)

■ Overview

Second order LPF step response waveform.

■ Application examples

- Simulates the step output waveform of a transmission system accompanied by ringing and overshooting

■ Meaning of each parameter

The example shows the case where the amplitude range is 0/+FS.

- Natural frequency of the LPF (Fn)

The frequency of the oscillation component is lower than Fn.

Variable range: 1.00 to 50.00 times fundamental frequency

- LPF Q (Q)

The oscillation component will disappear when the Q is 0.5.

Variable range: 0.50 to 50.00

The amplitude at infinite time is FS/2. The peak value is less than +FS.

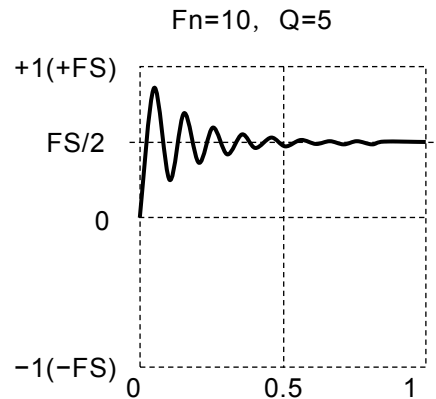

■ Waveform examples

The polarity and amplitude ranges are all Normal and 0/+FS.

Fn=5 Q=0.5	Fn=5 Q=1	Fn=10 Q=5	Fn=15 Q=20

■ Remarks

The oscillation frequency is expressed in the following formula (fundamental frequency standard).

$$Fn \cdot \sqrt{1 - \frac{1}{4 \cdot Q^2}}$$

d) Damped oscillation

■ Overview

Oscillation waveform with an amplitude that dampens exponentially. An oscillation waveform with an amplitude that increases exponentially can also be created.

■ Application examples

Simulates a pulse response waveform with oscillation.

■ Meaning of each parameter

The example shows the case where the amplitude range is  $\pm FS$ .

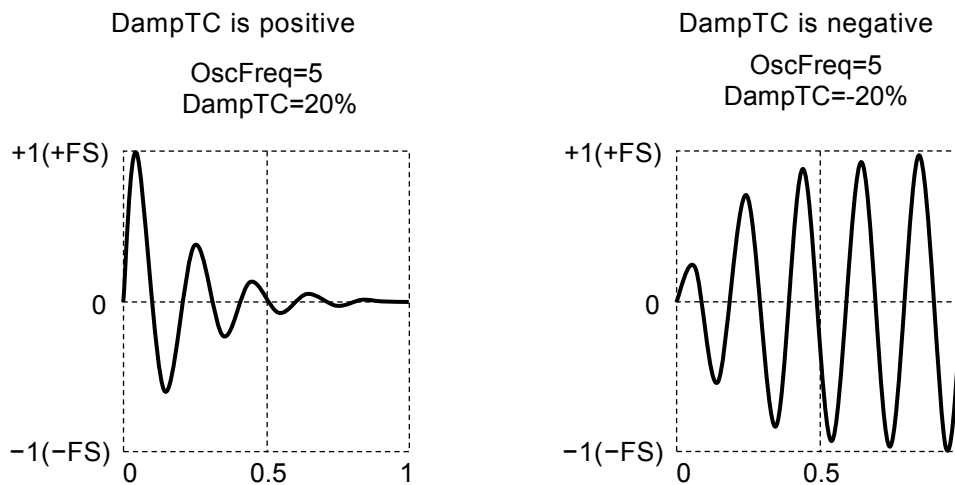

- Oscillation frequency (OscFreq)

Variable range: 0.01 to 50.00 times (fundamental frequency)

- Damped oscillation time constant (DampTC)

The oscillation exponentially dampens with this time constant when positive.

The oscillation exponentially increases with this time constant when negative.

Variable range: -100.00% to 100.00% of basic period

The peak value is fixed to +FS when the damped oscillation time constant is positive.

The oscillation is  $\pm FS$  over an infinite time when the damped oscillation time constant is negative.

■ Waveform examples

The polarity and amplitude ranges are all Normal and  $\pm FS$ .

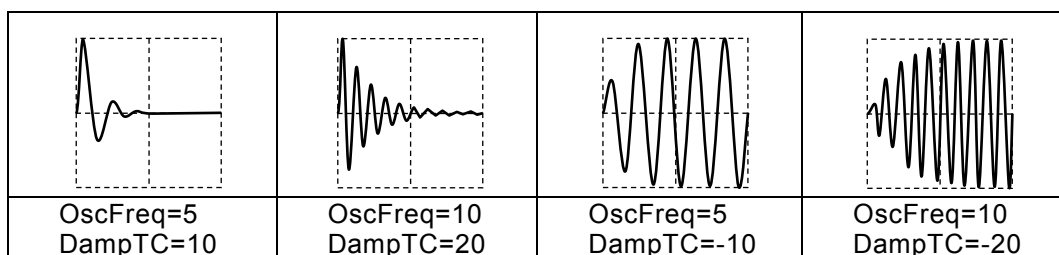

6.1.6 Surge Group

a) Oscillation surge

■ Overview

Simulates a surge waveform with damped oscillation.

The step response waveform of a cascade connection circuit with a first order HPF and a second order LPF.

■ Application examples

- Simulates a surge waveform superimposed on a power supply
- Simulates the rush current waveform of a power supply

■ Meaning of each parameter

The example shows the case where the amplitude range is  $\pm FS$ .

- Oscillation frequency (OscFreq)
 

Variable range: 0.01 to 50.00 times fundamental frequency
- Damped oscillation time constant (DampTC)
 

The amplitude of the oscillation component exponentially attenuates with this time constant.  
Variable range: 0.01% to 100.00% of basic period
- Trailing time constant (TrailTC)
 

Damping time constant of the waveform without the oscillation component (first order HPF time constant).  
Variable range: 0.01% to 100.00% of basic cycle

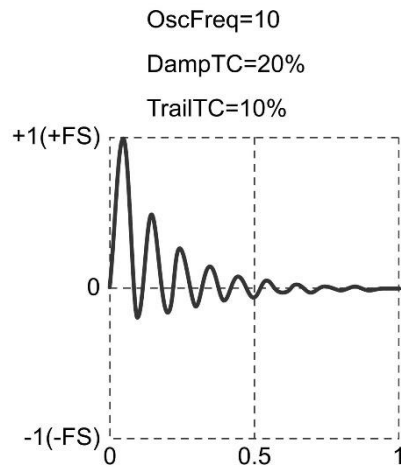

Peak value is fixed to +FS. Please note that the amplitude also oscillates in the negative direction.

■ Waveform examples

The polarity and amplitude ranges are all Normal and  $\pm FS$ .

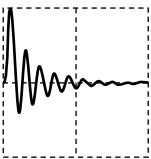
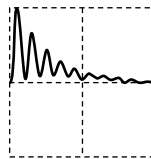
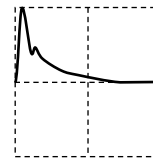
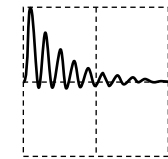
			
OscFreq=10 DampTC=20 TrailTC=5	OscFreq=10 DampTC=20 TrailTC=30	OscFreq=10 DampTC=5 TrailTC=20	OscFreq=10 DampTC=30 TrailTC=20

b) Pulse surge

■ Overview

Simulates a surge waveform. Does not have an oscillation component.

■ Application examples

- Simulates the transient voltage waveform of a car battery

■ Meaning of each parameter

The example shows the case where the amplitude range is 0/+FS.

• Rising time (Tr)

Time for the amplitude to change from 10% to 90% of the peak value.

Variable range: 0.01% to 100.00% of basic period

• Time duration (Td)

Pulse width with an amplitude 10% or greater of the peak value.

Variable range: 0.01% to 100.00% of basic period

Peak value is fixed to +FS.

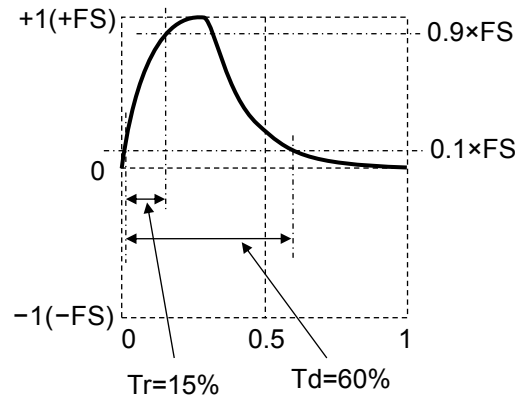

■ Waveform examples

The polarity and amplitude ranges are all Normal and 0/+FS.

Tr=1 Td=20	Tr=20 Td=50	Tr=5 Td=30	Tr=5 Td=80

■ Remarks

The prescribed waveform will not be created unless the condition that approx.  $1.839 < Td / Tr$  is satisfied.

The end does not decrease all the way down to zero. Please note that the greater the time duration, the higher the end will rise above the zero level.

6.1.7 Other group

a) Trapezoid wave with offset

■ Overview

Trapezoid wave with an offset in the amplitude direction.

■ Application examples

- Simulates the various voltages and current waveforms of a switching power supply circuit

■ Meaning of each parameter

The example shows the case where the amplitude range is 0/+FS.

• Leading delay (Delay)

The rising start position of the trapezoid wave.

Variable range: 0.00% to 100.00% of basic period

• Rising slope width (Rise)

The width of the rising portion.

Variable range: 0.00% to 100.00% of basic period

• Upper base width (UpperBase)

The width of the upper base.

Variable range: 0.00% to 100.00% of basic period

• Falling slope width (Fall)

The width of the falling portion.

Variable range: 0.00% to 100.00% of basic period

• Offset

The amplitude direction offset of the entire trapezoid. Variable range: 0.00% to 100.00%

The peak value is fixed to +FS at the upper base.

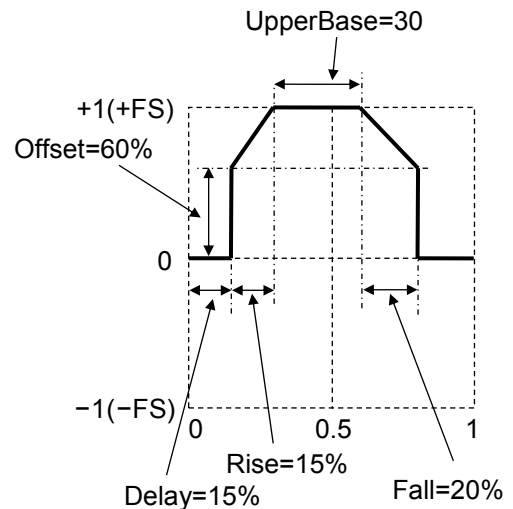

■ Waveform examples

The polarity and amplitude ranges are all Normal and 0/+FS.

Delay=15 Rise=10 UpperBase=20 Fall=30 Offset=0	Delay=15 Rise=40 UpperBase=0 Fall=0 Offset=60	Delay=15 Rise=0 UpperBase=20 Fall=30 Offset=0	Delay=20 Rise=40 UpperBase=0 Fall=0 Offset=0

**b) Half-sine edge pulse**

■ Overview

Pulse wave with variable rising time, falling time, and pulse width duty.

The rising and falling shapes have the same half sine (half cycle of a sine wave) shape as a standard pulse wave. Since a standard pulse wave cannot be used in sequence oscillation, this wave is read into arbitrary waveforms and used instead.

■ Meaning of each parameter

The example shows the case where the amplitude range is 0/+FS.

- Rising time (LE)
 

Time for the amplitude to change from 10% to 90% of the peak value.

Variable range: 0.00% to 100.00% of basic period
- Trailing time (TE)
 

Time for the amplitude to change from 90% to 10% of the peak value.

Variable range: 0.00% to 100.00% of basic period
- Duty (Duty)
 

Pulse width duty with an amplitude 50% or greater of the peak value.

Variable range: 0.00% to 100.00%

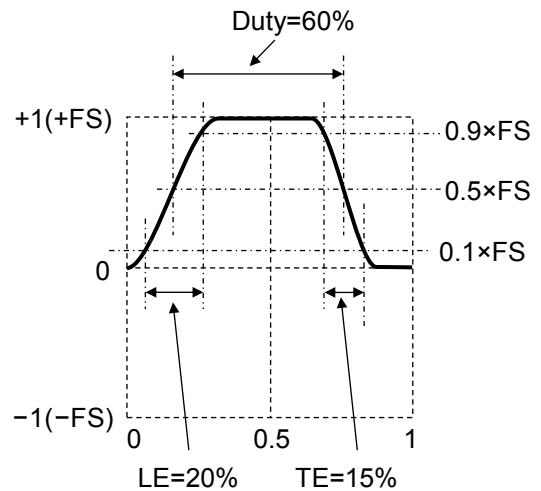

Peak value is fixed to +FS.

■ Waveform examples

The polarity and amplitude ranges are all Normal and 0/+FS.

LE=10 TE=20 Duty=40	LE=30 TE=5 Duty=60	LE=10 TE=10 Duty=20	LE=10 TE=0 Duty=70

■ Remarks

The prescribed waveform will not be created unless the following formula is satisfied.

$$0.85 (LE + TE) \leq \text{Duty} \leq 100 - 0.85 (LE + TE)$$



c) Bottom referenced ramp

■ Overview

Ramp wave with bottom level as reference.

■ Meaning of each parameter

The example shows the case where the amplitude range is 0/+FS.

• Symmetry (Symm)

The ratio of the rising portion.

Variable range: 0.00% to 100.00%

Peak value is fixed to +FS.

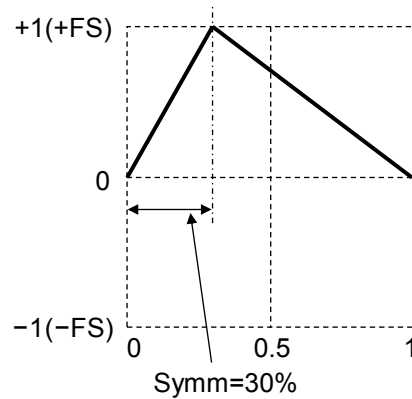

■ Waveform examples

The polarity and amplitude ranges are all Normal and 0/+FS.

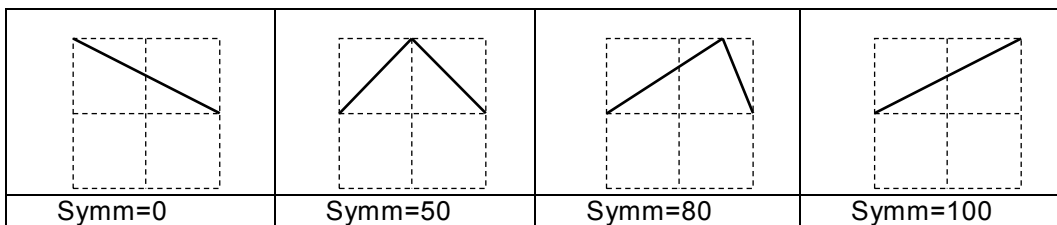

■ Remarks

The zero-phase degree is fixed to the bottom level except when the symmetry is 0%.

In a standard ramp wave, the zero-phase degree is fixed to the amplitude's center zero point.

☞ P.4-55

d) Double pulse

■ Overview

This is a pulse of 2 waves. Rising and falling are both linear.

■ Application examples

- Measure the switching characteristics of MOSFET

■ Meaning of each parameter

The example shows the case where the amplitude range is 0/+FS.

- Rising slope time (LeadingTime)  
This is the leading edge time.  
Variable range: 0.00% to 100.00% of basic period
- Falling slope time (TrailingTime)  
This is the trailing edge time.  
Variable range: 0.00% to 100.00% of basic period
- Lower Base 1 (LowerBase1)  
This is the width of the lower base of the first wave.  
Variable range: 0.00% to 100.00% of basic period
- Upper Base 1 (UpperBase1)  
This is the width of the upper base of the first wave.  
Variable range: 0.00% to 100.00% of basic period
- Lower Base 2 (LowerBase2)  
This is the width of the lower base of the second wave.  
Variable range: 0.00% to 100.00% of basic period
- Upper Base 2 (UpperBase2)  
This is the width of the upper base of the second wave.  
Variable range: 0.00% to 100.00% of basic period  
The peak value is fixed to +FS at the upper base.  
Please note that the end will be greater than zero if  $((LE+TE) \times 2 + \text{other parameter})$  exceeds 100%.

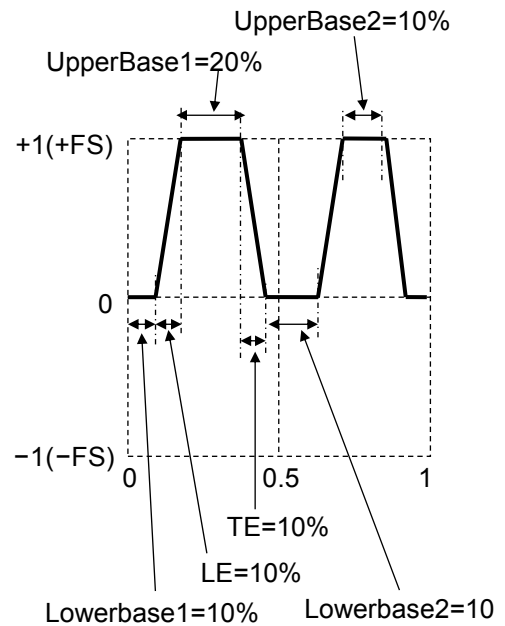

■ Waveform examples

The polarity and amplitude ranges are all Normal and 0/+FS.

LE=0 TE=0 LowerBase1=10 UpperBase1=30 LowerBase2=30 UpperBase2=20	LE=20 TE=10 LowerBase1=10 UpperBase1=30 LowerBase2=10 UpperBase2=10	LE=20 TE=0 LowerBase1=0 UpperBase1=0 LowerBase2=0 UpperBase2=0	LE=0 TE=20 LowerBase1=10 UpperBase1=10 LowerBase2=10 UpperBase2=10

## 7. Creating Arbitrary Waveforms

7.1	Basics .....	7-2
7.2	Display Procedure and Overview of Screen for Creating/Editing Arbitrary Waveforms.....	7-5
7.3	Creating New Arbitrary Waveform .....	7-7
7.4	Example of Creating Simple Arbitrary Waveform .....	7-7
7.5	Outputting Created Arbitrary Waveform .....	7-9
7.6	Saving Created Arbitrary Waveform .....	7-9
7.7	To Retrieve the Saved Arbitrary Waveform .....	7-12
7.8	File Operations .....	7-14
7.9	Identifying Memory Space Required for Saving Arbitrary Waveforms .....	7-18

## 7.1 Basics

There are mainly the following two methods to create arbitrary waveforms:

- Enter waveform data from the panel.
- Use the arbitrary waveform editing software to create arbitrary waveforms on a personal computer.

This section describes the method to create arbitrary waveforms by performing operations on the panel of the main unit.

Before doing so, you need to understand some points about the arbitrary waveforms of this product.

### ■ Two types of data formats

There are the following two types of data formats for the arbitrary waveform data of this product:

#### • Array format

The data sequence corresponding to the address of a waveform memory.

This is the data format for using a waveform acquired with an oscilloscope as an arbitrary waveform.

Waveform data in text format imported by the oscilloscope can be transferred to this product using the arbitrary waveform editing software.

Array format data cannot be created or edited on the panel. Also, it cannot be copied to edit memory.

Waveform length of the array format is 16 to 64Mi words.

To reduce the time to switch waveforms, reduce the number of data points as much as possible.

#### • Control point format

A waveform is created by linearly interpolating between specified points (control points).

A waveform can be created or edited manually from the panel.

The data value for each memory address cannot be specified directly.

The number of control points in the control point format can be 2 to 10 000 points.

For a waveform to be created, its time axis direction is fixed to 0 to 1 per cycle and its amplitude direction is fixed to  $\pm 1$  (equivalent to  $\pm FS$  of waveform memory).

If the number of control points is high and the set frequency is high, thinning out may occur.

### ■ Relationship between the number of data, frequency, and sampling frequency

The period of the waveform is an inverse number of the frequency of the waveform. The sample period is an inverse number of the sample frequency. Setting by the waveform frequency, waveform period, sample frequency, and sample period are possible.

#### • Array format

The maximum sampling frequency is 240 MHz, so the maximum frequency at which all of the data will be generated is  $240 \text{ MHz} \div \text{number of data}$ . A frequency higher than that

cannot be set.

In addition, when the sample rate is 109 Ms/s or higher or less than 15 ms/s, the jitter reduction effect is dampened gradually.

Sampling rate	Up to 109 MHz	Up to 130 MHz	Up to 206 MHz	Up to 220 MHz	Up to 240 MHz
Jitter [ps rms]	<60	<63	94	125	195

- **Control point format**

There is no restriction on the frequency setting, but the characteristics of the waveform will be lost as the set frequency becomes higher. The sampling frequency is set automatically inside the unit.

- **Save location of arbitrary waveforms**

There are the following three save locations for arbitrary waveform data (separate from the memory for 1 Mi long output waveforms). Each memory is shared by two channels in the WF1984.

- **Internal storage memory**

This is non-volatile memory to save arbitrary waveforms.

The non-volatile memory can save up to 4 096 arbitrary waveforms for a total of 4 Gi words.

The arbitrary waveform data can be saved in either array format or control point format.

For the memory capacity required for saving,  P. 7-18

- **Edit memory**

This is volatile memory to create an arbitrary waveform in the control point format. You can change the number of control points between 2 and 10 000 points.

When creating/editing an arbitrary waveform on the panel, you are operating the data in this edit memory. Only one waveform can be handled in the edit memory. It is not possible to copy waveforms in array format to the edit memory.

- **External USB flash memory**

Arbitrary waveform data can be copied back and forth between this memory and the internal storage memory and edit memory. Arbitrary waveforms stored in USB flash memory cannot be directly output or directly edited in the unit. In order to edit or output the waveforms, first copy them to the edit memory or internal memory.

- Selection of arbitrary waveforms to be output

When setting a waveform as an arbitrary waveform in the Oscillator setting screen, you can select a waveform in internal memory or the edit memory.

The selected waveform is written to the output waveform memory with a maximum 64 Mi word length.

If you select an output waveform in the edit memory, the waveform you are creating/editing appears as is in the output. When a waveform is used as a sub-waveform, it will be converted to data with 4 096 points.

## 7.2 Display Procedure and Overview of Screen for Creating/Editing Arbitrary Waveforms

An arbitrary waveform is created or edited in the ARB Edit screen.

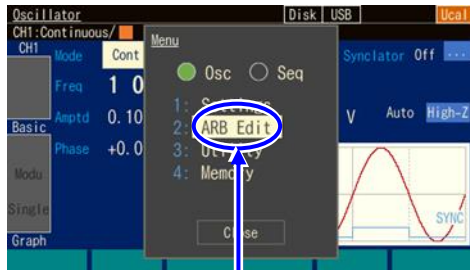

Select [ARB Edit]

1. Press the MENU key to open the top menu. Select [ARB Edit] and then press the ENTER key. The ARB Edit screen opens.

2. The ARB Edit screen has two types of display formats.

They are a list display, which displays values side by side, and a graph display. You can switch between displays using the tabs on the far left of the screen.

[Index] shows the control point numbers, beginning with zero (0). The start point is fixed to  $X = 0.000\ 000$ . Also, the end point is fixed to  $X = 1.000\ 000$ , and the pair of Y values for both the start and end points will be the same value (same point).

If an output waveform is set to the arbitrary waveform in the edit memory, the waveform being created appears as is in the output. If the output waveform is set to another waveform, when you select the [Apply] button and press the ENTER key, the setting of output waveform is changed to the arbitrary waveform in the edit memory, and the waveform being created appears in the output.

### ■ List display

List display shows the waveform being created and a list of control points.

The shape of the waveform is created by setting X and Y values for each control point.

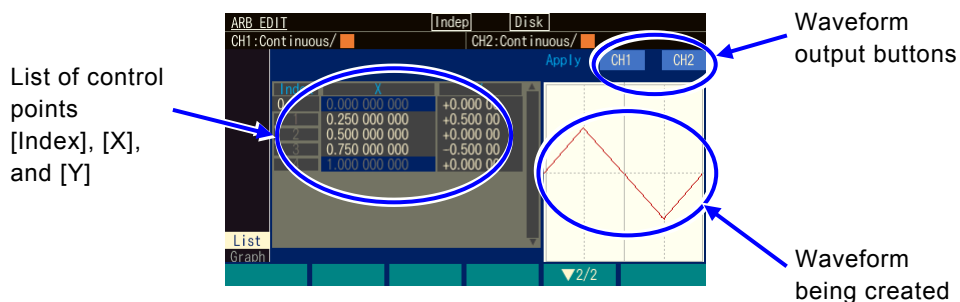

■ Graph display

Graph display shows the waveform being created in an enlarged state. The X and Y values of the one selected control point are displayed.

As with the list display, the shape of the waveform is created by setting the X and Y values for each control point.

You can enlarge the waveform display both horizontally and vertically centered on the selected control point.

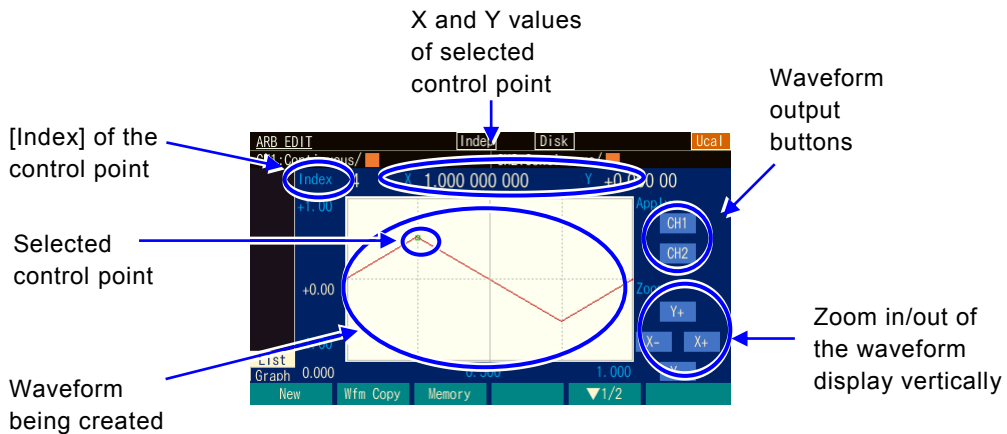

■ Soft keys

First row ([ ▼ 1/2] is displayed to the right side)



[New]: Clears the edit memory and initializes its state.

[Wfm Copy]: Copies a standard waveform in to the edit memory.

[Recall]: Copies the already saved arbitrary waveform in the control point format to the edit memory.

[Store]: Saves the waveform in the edit memory.

Second row ([ ▼ 2/2] is displayed to the right side)



[Index -1]: Decrements the value of [Index] by one.

[Index +1]: Increments the value of [Index] by one.

[Delete]: Deletes the selected control point.

[Insert]: Inserts a new control point between the selected control point and the control point just before the selected point.



## 7.3 Creating New Arbitrary Waveform

There are the following three methods to create new arbitrary waveforms:

- Create a new arbitrary waveform completely from the beginning  
First, press the [New] soft key to clear the edit memory. Then, enter the control points. The next section describes an example of creation.
- Create a new arbitrary waveform based on the standard waveform by making modifications  
First, press the [Wfm Copy] soft key to copy a standard waveform to the edit memory. Then, modify the control points. How to operate control points is the same as the case of creating a new arbitrary waveform completely from the beginning.  
However, the noise and DC of the standard waveform cannot be copied. In addition, square and pulse waves are copied as ideal square waves that keep their duty.
- Create a new waveform based on a saved arbitrary waveform by making modifications  
First, press the [Recall] soft key to copy the saved arbitrary waveform in the control point format into the edit memory. Then, modify the control points. How to operate control points is the same as the case of creating a new arbitrary waveform completely from the beginning.

With WF1984, the current values of the active channel are used for parameters (e.g., offset) of other than the specified waveform.

## 7.4 Example of Creating Simple Arbitrary Waveform

In this section, we will actually create a simple arbitrary waveform. The procedure is explained using list format display.

The arbitrary waveform to be created is a triangular wave as shown below. The number of control points of this waveform is three, but here we will start with two points and then change to three points part way through.

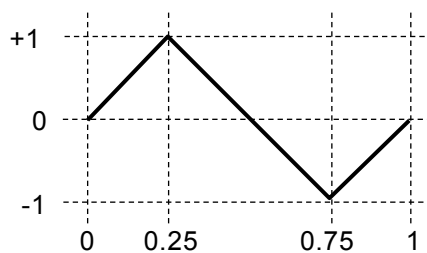

1. Press the [New] soft key and set the number of control points to 2. The settings will be as follows.

Index	X	Y
0	0.000 000	+0.000 000
1	0.500 000	+0.000 000
2	1.000 000	+0.000 000

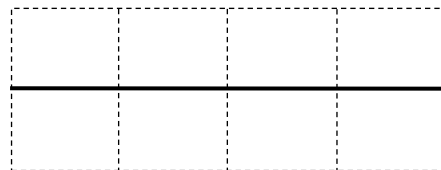

2. Change the settings of Index=1 to X=0.25 and Y=+1.

Index	X	Y
0	0.000 000	+0.000 000
1	0.250 000	+1.000 000
2	1.000 000	+0.000 000

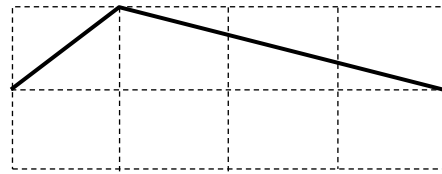

3. Select the Y value field of the end line (Index=2 and X=1) and then press the [Insert] soft key.

The control point of X=0.625000 and Y=+0.49998 is newly created. The values rounded to 16-bit resolution are displayed as the Y values, assuming  $\pm 32767$  to be  $\pm 1$ .

Index	X	Y
0	0.000 000	+0.000 000
1	0.250 000	+1.000 000
2	0.625 000	+0.499 998
3	1.000 000	+0.000 000

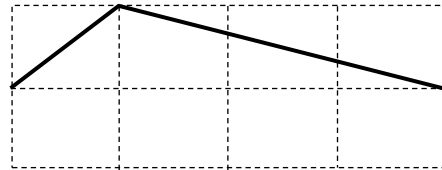

4. Change the settings of Index=2 to X=0.75 and Y=-1. This completes the procedure.

Index	X	Y
0	0.000 000	+0.000 000
1	0.250 000	+1.000 000
2	0.750 000	-1.000 000
3	1.000 000	+0.000 000

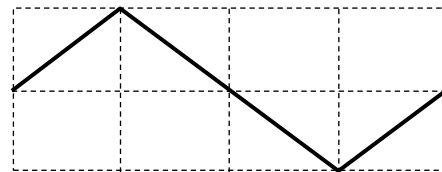

#### ✓ Check

- The X value can be changed within a range between the control point just before the X value and the control point just after the X value.
- The Y value is rounded to 16-bit resolution.
- To change the Y value to the form of a step, set the variation width between adjacent X values to the minimum value of 0.000 001.

## 7.5 Outputting Created Arbitrary Waveform

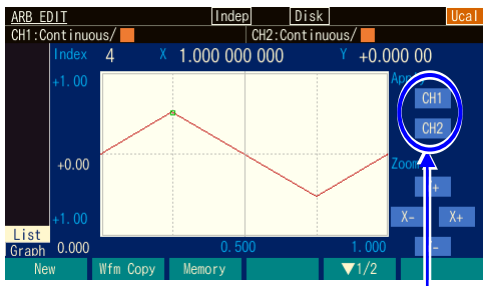

Select the [Apply] field at the top right of the screen and then press the ENTER key to output the waveform being created.

When you press CH1 or CH2, the waveform is output.

## 7.6 Saving Created Arbitrary Waveform



Press the [Memory] soft key to save.

Press the [Memory] soft key to switch to the screen for recalling, saving, and file operations. On this screen, you can select the unit's internal memory or USB flash memory as the save destination.

### 7.6.1 Saving to Internal Memory

Save the contents of the edit memory to the internal memory. You can also delete and rename arbitrary waveform data in the internal memory.

Select the memory number of the save destination here.

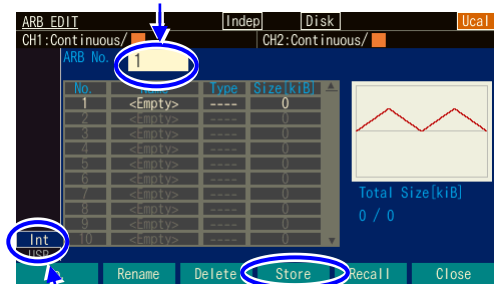

Select [Int] and press the ENTER key.

Press the [Store] soft key

1. When Int at the bottom left of the screen is selected, the data will be saved to the internal memory. If USB is selected, select Int and press the ENTER key.
2. Select an arbitrary memory number between 1 and 4 096 and then press the [Store] soft key to display the dialog box for entering a name.  
Delete an existing waveform memory with the [Delete] soft key, and rename it with the [Rename] soft key.

The dialog box to enter the name of the arbitrary waveform is displayed.

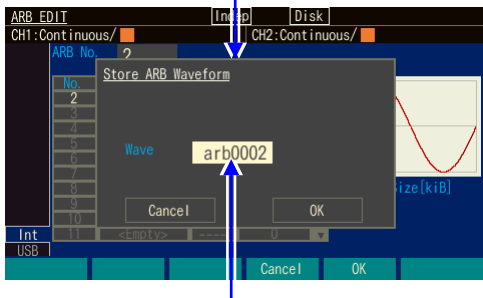

If you enter a name for the arbitrary waveform, select the [OK] soft key, and press the ENTER key, the waveform data is saved.

3. Enter the name of the arbitrary waveform in the [Wave] field and then press the [OK] soft key to save the contents of the edit memory to the internal memory.

### 7.6.2 Saving to USB Flash Memory

Save the contents of the edit memory to USB flash memory.

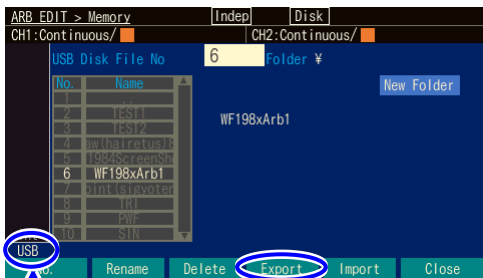

Select [USB] and press the ENTER key.

Press [Export] soft key

1. When USB at the bottom left of the screen is selected, the data will be saved to the internal memory [CO1]. If Int is selected, select [USB] and then press the ENTER key. When a folder is selected, pressing the [Enter] soft key makes that folder (selecting “..¥” moves one folder up) the current folder.

A dialog box for saving is opened.

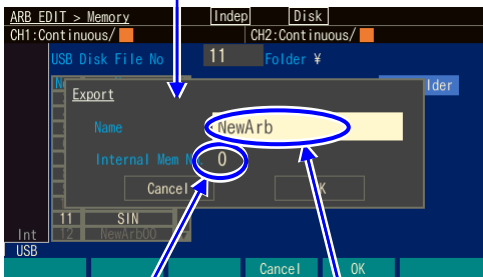

Enter the waveform number of the save source here.

Enter the file name in the file name input field.

2. Press the [Export] soft key to display the dialog box for saving arbitrary waveform data.
3. Enter the waveform number of the save source in the [Internal Mem No.] input field. If you want to save the edit memory, select number 0. A number other than that indicates that the internal memory is set as the save source. In the [Name] field, enter the name of the file to save. Press the [OK] soft key to save.

### a) File time stamps

This instrument does not have a built-in battery. Therefore, the time of the time stamp is off from the actual date and time by the amount of time that the instrument was not energized. The time stamp of a file created is the result of adding the amount of time that the instrument was energized to the date and time that the instrument made the adjustments. The date and time for the time stamp cannot be changed.

## 7.7 To Retrieve the Saved Arbitrary Waveform



Press the [Memory] soft key to retrieve.

Press the [Memory] soft key to switch to the screen for recalling, saving, and file operations. The internal memory or USB flash memory may be selected as the retrieve source on this screen.

### 7.7.1 To Retrieve from Internal Memory

Save the contents of the internal memory to the edit memory.

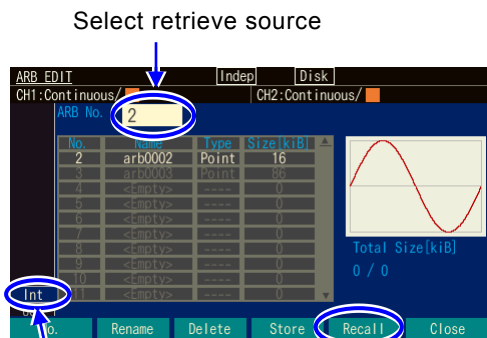

Select [Int] and press the ENTER key.

Press [Recall] soft key

1. When Int at the bottom left of the screen is selected, the data will be saved to the internal memory. When USB is selected, press the ENTER key to select Int.
2. Select an arbitrary memory number between 1 and 4 096 and select the [OK] soft key. The contents of the specified internal memory location are retrieved to the edit memory.  
On this screen, you can also delete an existing waveform memory with the [Delete] soft key, and rename it with the [Rename] soft key.

## 7.7.2 To Retrieve from USB Flash Memory

Save the arbitrary waveform data in USB flash memory to the internal memory. However, waveforms in array format cannot be copied to the edit memory.

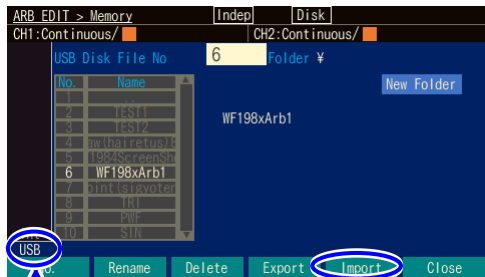

Select [USB] and press the ENTER key.

Press [Import] soft key

1. When USB at the bottom left of the screen is selected, the data will be saved to the internal memory. If Int is selected, select [USB] and then press the ENTER key. Pressing the [Enter] soft key while selecting a folder sets the current folder to the specified folder (or "..¥" for the folder above)

2. Press the [Export] soft key to display the dialog box for saving arbitrary waveform data.

A dialog box for saving is opened.

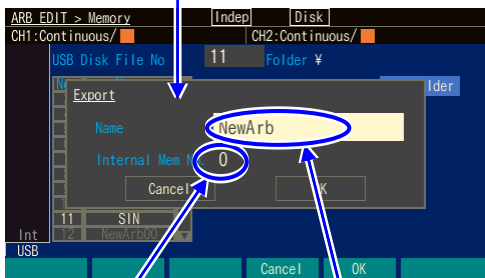

Enter the waveform number of the save source here.

Enter the file name in the file name input field.

3. Enter the waveform number of the save source in the [Internal Mem No.] input field. If you want to save the edit memory, select number 0. A number other than that indicates that internal memory is set as the save source.

In the [Name] field, enter the name of the file to save.

Press the [OK] soft key to recall the data from USB flash memory to internal memory.

The file name in USB flash memory will be the name of the copy destination.

## 7.8 File Operations

Perform the operations of deleting and renaming the arbitrary waveform data in internal memory and also deleting and renaming the arbitrary waveform data and creating, deleting, and renaming folders in USB flash memory on the Memory screen of ARB edit.

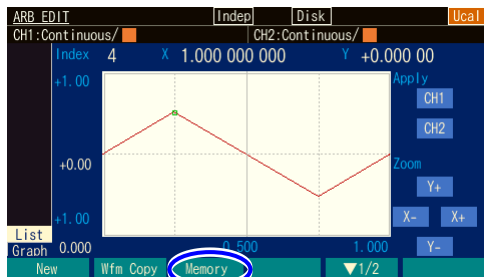

To perform file operations, press the [Memory] soft key.

Press the [Memory] soft key to switch to the screen for recalling, saving, and file operations.

### 7.8.1 To Delete Saved Arbitrary Waveform

To delete arbitrary waveform data in internal memory or delete arbitrary waveform data or a folder in USB flash memory, use the [Delete] soft key.

The arbitrary waveform memory of a number used as a waveform cannot be deleted.

Specify the number of the file you want to delete.

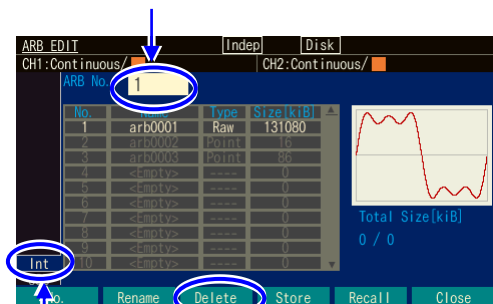

Select the Internal tab

Finally, press the Delete soft key.

1. Specify the target with a number in the file number selection field at the top left of the screen.
2. Press the [Delete] soft key to display a dialog box for deletion.



Specify the number of the file you want to delete.

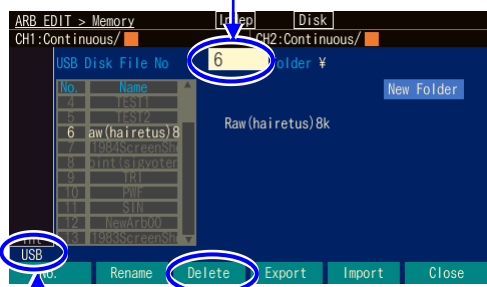

Select the USB tab

Finally, press the Delete soft key.

When the target is a file or folder in USB flash memory, a screen such as the one on the left will be displayed.

Folders have "¥" at the end of the name. When a folder is selected, pressing the [Enter] soft key makes that folder the current folder. ".. ¥" indicates the folder one level up.

The dialog box for deleting a file or folder is displayed.

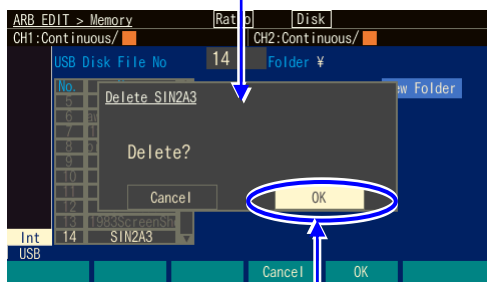

Press the [OK] soft key to delete.

3. Press the [OK] soft key to delete.

### 7.8.2 To Rename

To rename arbitrary waveform data in internal memory or rename arbitrary waveform data or a folder in USB flash memory, use the [Rename] soft key.

Specify the number of the file you want to rename.

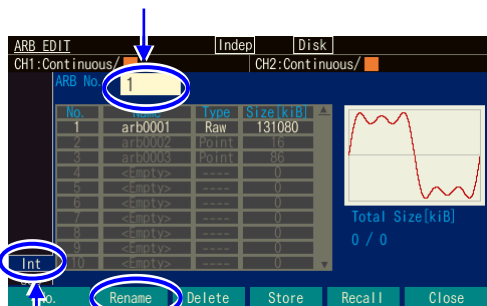

Select the Int tab

Finally, press the [Rename] soft key

1. Specify the target with a number in the file number selection field at the top left of the screen.

2. Press the [Rename] soft key to display a dialog box for renaming.

Select the file/folder by changing here. The name of the selected file or folder is displayed.

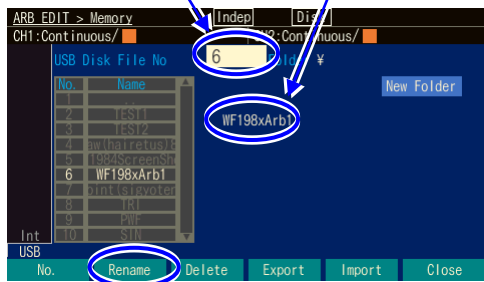

Finally, press the [Rename] soft key.

The dialog box for renaming a file or folder is displayed.

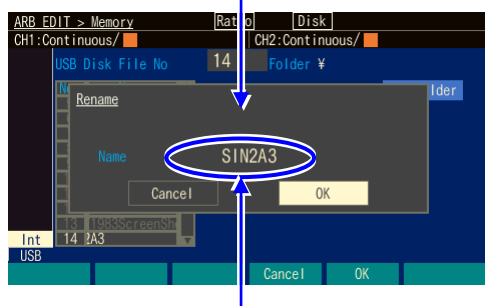

Select the [Name] field and then press the ENTER key to enable renaming.

When the target is a file or folder in USB flash memory, a screen such as the one on the left will be displayed.

Folders have "¥" at the end of the name. When a folder is selected, pressing the [Enter] soft key makes that folder the current folder. ".. ¥" indicates the folder one level up.

3. Select the [Name] field, press the ENTER key, and change the name. Move the cursor with the left and right arrow keys. Change a character with the up and down arrow keys or the modify knob. Once the name has been changed, press the [OK] soft key to confirm it. Press the [Cancel] soft key to discard the change.

### 7.8.3 To Create a Folder in USB Flash Memory

Folders have "¥" at the end of the name. When a folder is selected, pressing the [Enter] soft key makes that folder the current folder. ".. ¥" indicates the folder one level up.

Select the [New Folder] button and then press the ENTER key.

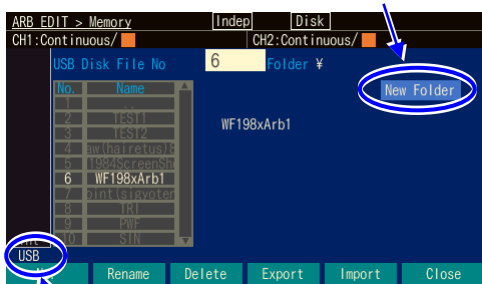

This indicates whether will be saved to the unit's internal memory or USB flash memory. To save to USB flash memory, select [USB] and press the ENTER key.

1. Select the [New Folder] button at the top right of the screen and press the ENTER key to open the dialog box for entering a folder name.

The dialog box for creating a folder is displayed.

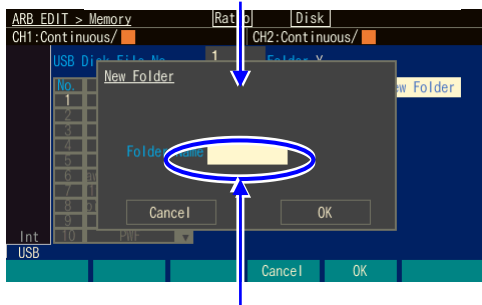

Select the [Folder Name] field, enter a name, and press the [OK] soft key to change the name.

2. Select the [New Folder] button at the top right of the screen and then press the ENTER key. Specify the target with a number in the file number selection field.

## 7.9 Identifying Memory Space Required for Saving Arbitrary Waveforms

A maximum of approximately 4 Gi words can be saved to the unit's internal non-volatile memory. The memory capacity (K-byte) required when saving an arbitrary waveform in the array format and control point format, respectively, is calculated by the following formula.

Array format:  $(2 \times \text{waveform length (word)} + 768) / 1024$  (round up to whole number)

Control point format:  $(8 \times \text{the number of control points} + 768) / 1024$  (round up to whole number)

The memory capacity required when saving an arbitrary waveform in the array format is shown in the following table:

Waveform size	1000W	10KW	100KW	1MW	10MW	64MiW
Memory capacity required for saving	11KiB	28KiB	204KiB	2MiB	20MiB	126MiB

An example of the memory capacity required when saving an arbitrary waveform in the control point format is shown in the following table:

Number of control points	2	10	100	300	1 000	2 000	5 000	10 000
Memory capacity required for saving	9KiB	9KiB	9KiB	11KiB	16KiB	24KiB	48KiB	87KiB

In the selection screen of the arbitrary waveform (common to both recalling and saving), the following items are displayed in addition to the waveform number ([No.]), and waveform name ([Name]).

- Data format [Type]: The waveforms in the array and control point formats are displayed as [RAW] and [Point], respectively. The edit memory of No. 0 is displayed as [Point] because it is in control point format.
- Save memory capacity [Size]: For arbitrary waveforms between No. 1 and 4 096, the memory capacity used for saving is displayed in Ki-bytes. For the edit memory of No. 0, the memory capacity required if it is saved is displayed in Ki-bytes.
- Total save memory capacity [Total Size]: Total memory capacity currently used for saving arbitrary waveforms between No. 1 and 4 096 is displayed in Ki-bytes. The size of edit memory of No. 0 is excluded from the total capacity.

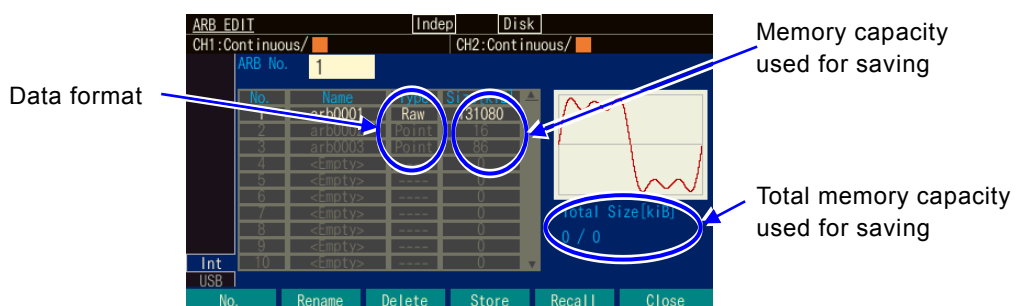

## 8. Convenient Use of 2-channel Equipment (WF1984 Only)

8.1	Outline .....	8-2
8.2	Copying Settings between Channels .....	8-3
8.3	Unifying Settings of 2 Channels .....	8-5
8.4	Synchronizing Phase between Channels.....	8-6
8.5	Keeping Frequencies for Both Channels Set to Same Value (2-Channel Coordination: 2Phase) .....	8-7
8.6	Keeping Frequency Difference Constant (2-Channel Coordination: 2Tone).....	8-9
8.7	Keeping Frequency Ratio Constant (2-Channel Coordination: Ratio) .....	8-11
8.8	Obtaining Differential Output (2-Channel Coordination: Differential) .....	8-13
8.9	Obtaining Double Output Voltage (2-Channel Coordination: Diff2).....	8-14

## 8.1 Outline

You can use 2-channel equipment like the WF1984 as not only two oscillators with each channel independent but also with the settings and operations coordinated between the two channels.

Functions specific to 2-channel equipment are as follows:

- Parameter copy function  
The settings of one channel can be copied to the other channel.  
In addition, the settings of each channel can be swapped. ⓘ P.8-3
- 2-channel equivalence setting function  
Values such as the amplitude and DC offset can be set to the same values for both channels.  
Operations such as turning output on/off can be performed simultaneously for both channels. ⓘ P.8-5
- Phase synchronization function  
The reference phase for each channel can be initialized. This function is used for 2-channel independent operation with the continuous oscillation mode. ⓘ P.8-6
- 2-channel coordination operation: 2-phase function  
The synchronization relationship with the same frequency can be kept. This function performs control to keep the synchronization relationship with the same frequency also during the frequency modulation or frequency sweep. ⓘ P.8-6
- 2-channel coordination operation: function with constant frequency difference  
The frequency can be changed while keeping the difference constant. This function performs control to keep the frequency difference constant also during the frequency modulation or frequency sweep. ⓘ P.8-9
- 2-channel coordination operation: function with constant frequency ratio  
The frequency can be changed with both the frequency ratio and synchronization relationship kept constant. This function performs control to keep the frequency ratio constant also during the frequency modulation or frequency sweep. ⓘ P.8-11
- 2-channel coordination operation: differential output function  
The reverse phase waveform can be output with the same frequency, amplitude, and DC offset. This function performs control to keep the reverse phase waveform also during the frequency modulation or frequency sweep. ⓘ P.8-13
- 2-channel coordination operation: differential 2 function  
The reverse phase waveform can be output with the same frequency and amplitude. In this mode, the polarity of DC offset is also reversed, which is different from the differential output function. Therefore, when the hot sides of CH1 and CH2 are used as the output, including DC, double output voltage can be obtained. ⓘ P.8-14

## 8.2 Copying Settings between Channels

The settings can be copied between channels in the Utility screen.

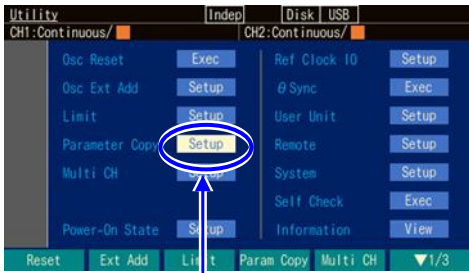

In the Utility screen, select [Parameter Copy] and then press the ENTER key.

The Parameter copy window is opened

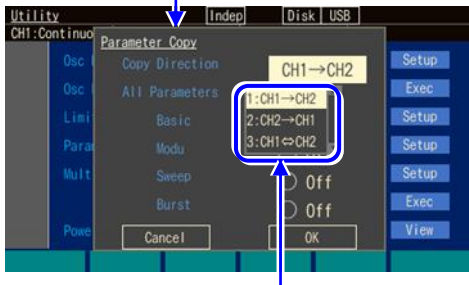

Select a copy direction

1. In the Utility screen, select [Parameter Copy] and then press the ENTER key.

2. After the Parameter copy window opens, select the [Copy Direction] field, and then press the ENTER key.

A list to select the copy direction opens.

You can select a copy direction from the following three types: [CH1 ⇒ CH2] (CH1 to CH2), [CH2 ⇒ CH1] (CH2 to CH1), and [CH1 ⇔ CH2] (swap CH1 and CH2).

Select the desired direction, and then press the ENTER key.

3. Next, select a parameter type to copy.

For the parameter type to copy, set [All Parameters] for all parameters or select from the parameters of individual oscillation modes. There are four parameter types for individual oscillation modes: [Basic] (basic parameters), [Modu] (parameters for the modulation function), [Sweep] (parameters for sweep oscillation), and [Burst] (parameters for burst oscillation).

Selecting the desired parameter type and pressing the ENTER key sets it as the copy target and displays [Copy]. Pressing the ENTER key again excludes it from the copy target and displays [Off].

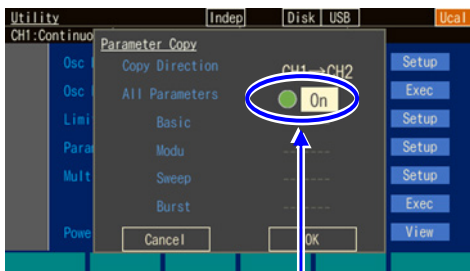

Copy all parameters

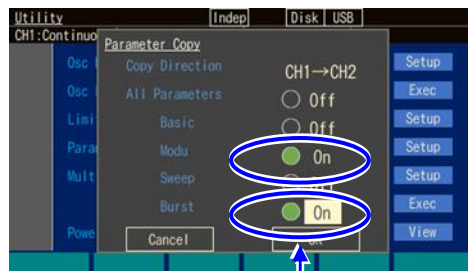

Copy the modulation and burst parameters

## 8.2 Copying Settings between Channels

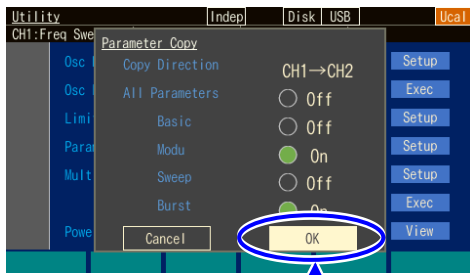

Select [OK] and then press the ENTER key to make a copy.

4. When the above setting is completed, select [OK] at the bottom of the window, and then press the ENTER key. The copy operation is performed.

When you do not want to copy, select [Cancel] at the bottom of the window and press the ENTER key, or press the CANCEL key.

### ■ Remarks

Copying all of [Basic], [Modu], [Sweep], and [Burst] is not equivalent to copying [All Parameters].

The following items are copied only when copying [All Parameters]:

- Output on/off state
- Oscillation mode
- External addition setting
- User-defined units
- Start-up output on/off setting
- With the basic parameter setting (for copying of [Basic], the waveform parameter settings are copied only for the waveform currently used in the copy source)
- Amplitude/DC offset setting or high level/low level setting
- Setting range limit value

For copying other than [All Parameters], any setting value exceeding the setting range limit value of the copy destination is not copied.



## 8.3 Unifying Settings of 2 Channels

To unify the settings of 2 channels, set the 2-channel equivalence setting function (CH LINK) to On in the Utility screen. This function is enabled until the 2-channel equivalence setting function is reset to off.

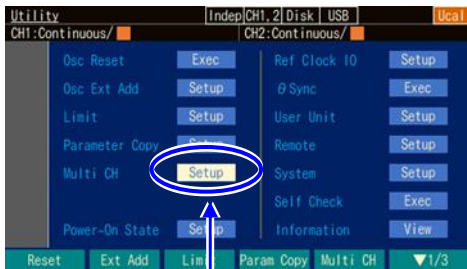

Select Multi CH and then press the ENTER key.

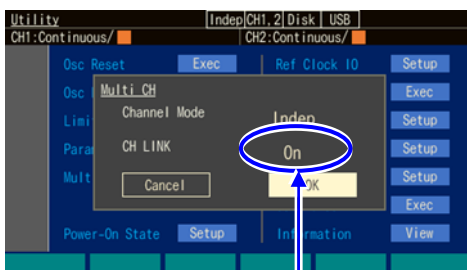

Set [CH LINK] to On and then press [OK].

1. In the Utility screen, select [Multi CH] and press the ENTER key.

2. Set the 2-channel equivalence setting function (CH LINK) to On in the Utility screen. Next, set items to which you want to set the same settings. When you set the settings for one channel, the same settings are set for the same items of the other channel.

### ■ Remarks

The 2-channel equivalence setting function (CH LINK) is valid for the following setting items.

- Frequency
- Phase
- Amplitude
- DC Offset
- Oscillation mode
- Waveform
- Output on/off
- Trigger burst
- Start / Operation of sweep

In addition to the Utility screen, you can switch between on and off by holding down the [CH SEL] key for 1 or more seconds.

## 8.4 Synchronizing Phase between Channels

Even if you set the frequency and phase to the same values using the 2-channel equivalence setting function, the phase relationship between the output waveforms from the 2 channels is changed accordingly. To synchronize the phases, the phase synchronous operation is required.

This synchronous operation is used for 2-channel independent operation (the channel mode setting is set to [Indep]).

If you want to always keep the same frequency or frequency ratio and need a phase synchronization state, use the 2-channel coordination function. [P.8-6, P.8-11](#)

For synchronization of multiple units, [P. 9-2](#)

### ■ Performing synchronization



In the Utility screen, select [ØSync] and then press the ENTER key to execute the phase synchronization

First, set the channel mode to [Indep] and set the frequency setting for both channels to the same value.

The synchronous operation is performed in the Utility screen.

Select [ØSync] in the Utility screen, and then press the ENTER key. Alternatively, press and hold the TRIG key.

This runs the phase synchronization.

At this time, the phase will be discontinuous temporarily because both channels stop the oscillation once.

### ■ Phase relationship after synchronous operation

The oscillation phase for each channel is initialized by the synchronous operation. The phase difference of the output waveform appears as the difference of the phase setting for each channel. Even if synchronous operation is performed, the synchronization relationship will be lost if the frequency is changed later. Perform synchronous operation again.

### ■ Operational restrictions

There are the restrictions shown in the following table for synchronous operation. The synchronous operation is used for 2-channel independent operation. Even if the synchronous operation is invalid, performing synchronous operation causes both channels to stop the oscillation once.

Item	Restriction
Waveform	Invalid for noise and DC.
Modulation	Invalid for FM and FSK.
Sweep Oscillation Mode	Invalid for frequency sweep. Invalid for gated single sweep.
Burst Oscillation Mode	Invalid .

The delay time varies depending on the output range. Therefore, when the range is different between the channels, the apparent phase difference becomes larger.

## 8.5 Keeping Frequencies for Both Channels Set to Same Value (2-Channel Coordination: 2Phase)

If the channel mode is [2Phase], you can change the frequency with the frequencies for both channels kept to the same value while the synchronization relationship is kept. In coordination with the change of the frequency of channel 1, the frequency of channel 2 is automatically changed. Channel 2 coordinates with channel 1 also during the frequency modulation or frequency sweep. This function is disabled for the burst oscillation and gated single sweep.

### ■ Selecting 2-channel coordination

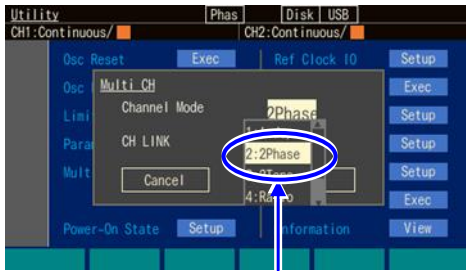

Set [Channel Mode] to [2Phase]

In the Utility screen, set [Channel Mode] to [2Phase] ([Indep] is normally set).

This sets the channel mode to 2-phase oscillation.

The frequencies for both channels will be the same, and phase synchronization will run automatically. Even if the frequency is changed, the synchronization relationship is kept.

This function performs control to keep the synchronization relationship with the same frequency also during the frequency modulation or frequency sweep.

For 2-phase oscillation, settings related to the frequency can be set only for channel 1.

### ■ Changing phase difference between channels

You can set a phase for each channel in the Oscillator setting screen. The phase between channels appears as the difference for each phase setting.

Normally, set the phase of the phase reference channel (for example, channel 1) to 0 degree and change only the phase setting of channel 2. At this time, the phase setting of channel 2 is a phase of channel 2 based on the channel 1. As shown in the figure below, if the phase setting of channel 2 is positive, channel 2 precedes channel 1, and if it is negative, channel 2 lags behind channel 1.

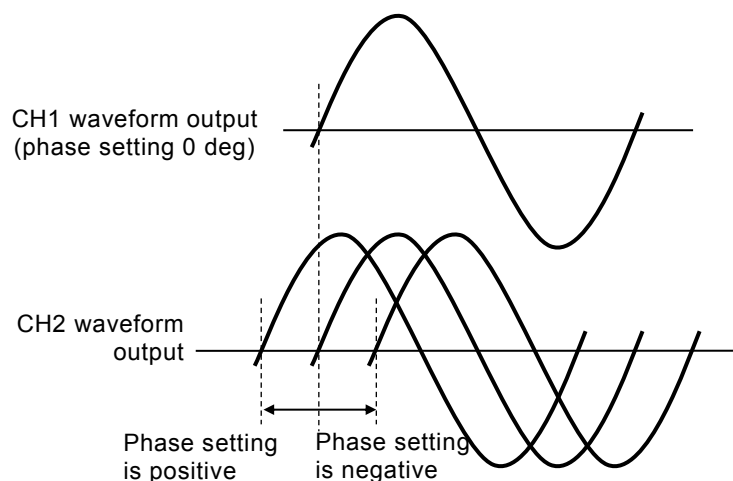

## 8.5 Keeping Frequencies for Both Channels Set to Same Value (2-Channel Coordination: 2Phase)

### ■ Operational restrictions

There are the restrictions shown in the following table to keep the synchronization relationship with the same frequency:

Item		Restriction
Waveform		Disabled for noise and DC.
Modulated oscillation mode	FM	Both CHs are FM. Peak deviation is common. Modulation source is internal only. Internal modulation waveform and internal modulation frequency are common.
	FSK	Both CHs are FSK. Hop frequency is common. Internal modulation frequency is common.
	PM	Both CHs are PM. Modulation setting is independent for each CH.
	PSK	Both CHs are PSK. Modulation setting is independent for each CH.
	AM	Both CHs are AM. Modulation setting is independent for each CH.
	DC offset modulation	Both CHs are DC offset modulation. Modulation setting is independent for each CH.
	PWM	Both CHs are PWM. Modulation setting is independent for each CH.
Sweep oscillation mode	Frequency sweep	Both CHs are frequency sweep. Sweep function, sweep range, sweep time, and sweep mode are common. Gated single sweep is not used. Single sweep trigger source and sweep internal trigger oscillator are common. External trigger source is enabled only for CH1 side.
	Phase sweep	Both CHs are phase sweep. Sweep setting is independent for each CH.
	Amplitude sweep	Both CHs are amplitude sweep. Sweep setting is independent for each CH.
	DC offset sweep	Both CHs are offset sweep. Sweep setting is independent for each CH.
	Duty sweep	Both CHs are duty sweep. Sweep setting is independent for each CH.
Burst Oscillation Mode		Cannot be used.

Both channels have the same type of modulation or sweep during the modulation or sweep. If another channel does not need the modulation (other than FM and FSK) or sweep (other than the frequency sweep), set the modulation width or sweep width of the channel to zero (0).

## 8.6 Keeping Frequency Difference Constant (2-Channel Coordination: 2Tone)

If the channel mode is constant frequency difference [2Tone], you can change the frequency with the frequency difference between both channels kept constant. In coordination with the change of the frequency of channel 1, the frequency of channel 2 is automatically changed. Channel 2 coordinates with channel 1 also during the frequency modulation or frequency sweep. This function is disabled for the burst oscillation and gated single sweep.

### ■ Selecting 2-channel coordination



Set [Channel Mode] to [2Tone]

In the Utility screen, set [Channel Mode] to constant frequency difference [2Tone] ([Indep] (independent) is normally set).

This sets the channel mode to constant frequency difference oscillation.

The frequency difference between both channels is kept constant.

This function performs control to keep the frequency difference constant also during the frequency modulation or frequency sweep.

For the oscillation with the constant frequency difference, you cannot set the frequency of channel 2 directly.

### ■ To set the frequency difference



Set [ $\Delta$ Freq] of CH2

1. On page 1 of the Oscillator screen, set the frequency difference in [ $\Delta$ Freq] of channel 2. The frequency of channel 2 results from adding this frequency difference to the frequency of channel 1. Select [...] of the [ $\Delta$ Freq] field and then press the ENTER key to display a dialog box for setting the frequency difference.

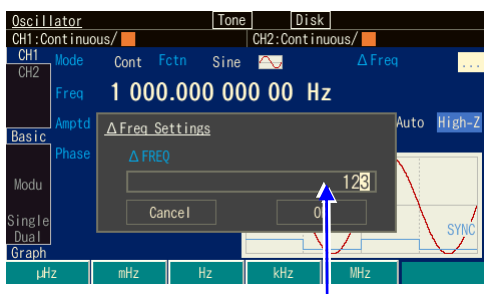

Open the [ $\Delta$ Freq] input field and set the frequency difference.

2. When the dialog box is displayed, select the [ $\Delta$ Freq] input field and then press the ENTER key to open the input field.

■ Operational restrictions

There are the restrictions shown in the following table to keep the frequency difference:

Item		Restriction
Waveform		Disabled for noise and DC
Modulated oscillation mode	FM	Both CHs are FM. Peak deviation is common. Modulation source is internal only. Internal modulation waveform and internal modulation frequency are common.
	FSK	Both CHs are FSK. Hop frequency follows the frequency difference. Internal modulation frequency is common.
	PM	Both CHs are PM. Modulation setting is independent for each CH.
	PSK	Both CHs are PSK. Modulation setting is independent for each CH.
	AM	Both CHs are AM. Modulation setting is independent for each CH.
	DC offset modulation	Both CHs are DC offset modulation. Modulation setting is independent for each CH.
	PWM	Both CHs are PWM. Modulation setting is independent for each CH.
Sweep oscillation mode	Frequency sweep	Both CHs are frequency sweep. Sweep range follows the frequency difference. Sweep function, sweep time, and sweep mode are common. Gated single sweep is not used. Single sweep trigger source and sweep internal trigger oscillator are common. External trigger source is enabled only for CH1 side.
	Phase sweep	Both CHs are phase sweep. Sweep setting is independent for each CH.
	Amplitude sweep	Both CHs are amplitude sweep. Sweep setting is independent for each CH.
	DC offset sweep	Both CHs are offset sweep. Sweep setting is independent for each CH.
	Duty sweep	Both CHs are duty sweep. Sweep setting is independent for each CH.
Burst Oscillation Mode		Cannot be used.

Both channels have the same type of modulation or sweep during the modulation or sweep. If another channel does not need the modulation (other than FM and FSK) or sweep (other than the frequency sweep), set the modulation width or sweep width of the channel to zero (0).

The frequency difference of the hop frequency in FSK is restricted to the setting resolution of the hop frequency.

If you select the logarithmic sweep as the frequency sweep, channel 1 performs the logarithmic sweep, but channel 2 does not perform the logarithmic sweep because channel 2 follows with the constant frequency difference.

## 8.7 Keeping Frequency Ratio Constant (2-Channel Coordination: Ratio)

If the channel mode is constant frequency ratio [Ratio], you can change the frequency with the frequency ratio between both channels kept constant. In coordination with the change of the frequency of channel 1, the frequency of channel 2 is automatically changed.

Channel 2 coordinates with channel 1 also during the frequency modulation or frequency sweep. This function is disabled for the burst oscillation and gated single sweep.

### ■ Selecting 2-channel coordination

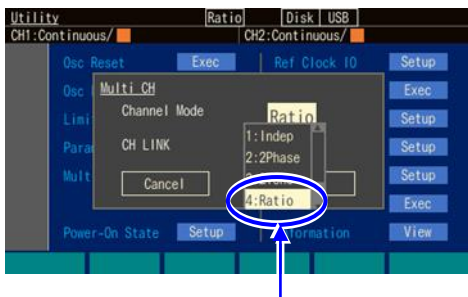

Set [Channel Mode] to [Ratio]

In the Utility screen, set [Channel Mode] to constant frequency ratio [Ratio] ([Indep] (independent) is normally set).

This sets the channel mode to constant frequency ratio oscillation.

The frequency ratio between both channels is kept constant.

This function performs control to keep the frequency ratio constant also during the frequency modulation or frequency sweep.

For the oscillation with the constant frequency ratio, you cannot set the frequency of channel 2 directly.

### ■ To set the frequency ratio

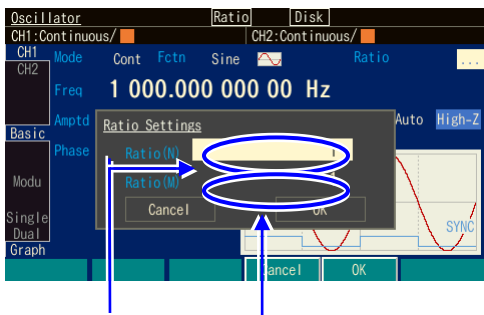

Set [Ratio(N)] and [Ratio(M)] of CH2

In the Oscillator screen, set the frequency ratio in [Ratio(N)] and [Ratio(M)] of channel 2.

Frequency of channel 2: Frequency of channel 1 will be N:M.

If you change the frequency ratio, the phase will be discontinuous temporarily because both channels stop the oscillation once.

■ Operational restrictions

There are restrictions shown in the following table to keep the frequency ratio:

Item		Restriction
Waveform		Disabled for noise and DC
Modulated oscillation mode	FM	Both CHs are FM. Peak deviation follows the frequency ratio. Modulation source is internal only. Internal modulation waveform and internal modulation frequency are common.
	FSK	Both CHs are FSK. Hop frequency follows the frequency ratio. Internal modulation frequency is common.
	PM	Both CHs are PM. Modulation setting is independent for each CH.
	PSK	Both CHs are PSK. Modulation setting is independent for each CH.
	AM	Both CHs are AM. Modulation setting is independent for each CH.
	DC offset modulation	Both CHs are DC offset modulation. Modulation setting is independent for each CH.
	PWM	Both CHs are PWM. Modulation setting is independent for each CH.
Sweep oscillation mode	Frequency sweep	Both CHs are frequency sweep. Sweep range follows the frequency ratio. Sweep function, sweep time, and sweep mode are common. Gated single sweep is not used. Single sweep trigger source and sweep internal trigger oscillator are common. External trigger source is enabled only for CH1 side.
	Phase sweep	Both CHs are phase sweep. Sweep setting is independent for each CH.
	Amplitude sweep	Both CHs are amplitude sweep. Sweep setting is independent for each CH.
	DC offset sweep	Both CHs are offset sweep. Sweep setting is independent for each CH.
	Duty sweep	Both CHs are duty sweep. Sweep setting is independent for each CH.
Burst Oscillation Mode		Cannot be used.

Both channels have the same type of modulation or sweep during the modulation or sweep. If another channel does not need the modulation (other than FM and FSK) or sweep (other than the frequency sweep), set the modulation width or sweep width of the channel to zero (0).

The peak deviation in FM and the frequency ratio of the hop frequency in FSK are restricted to individual frequency setting resolution.

The peak deviation in FM and the frequency ratio of the hop frequency in FSK are restricted to the frequency setting range or setting range limit value, respectively.



## 8.8 Obtaining Differential Output (2-Channel Coordination: Differential)

If the channel mode is [Diff], you can change the setting with the differential output of both channels kept. In this 2-channels coordination mode, the DC offset setting is the same for channel 1 and channel 2. In coordination with the change of the setting of channel 1, the setting of channel 2 is automatically changed. Coordination is performed also during modulations or sweeps. When the hot sides of CH1 and CH2 are used as the output, the output impedance will be 100  $\Omega$ .

### ■ Selecting 2-channel coordination

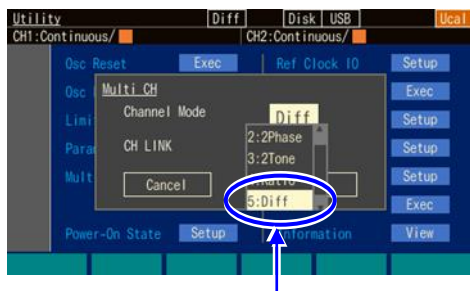

Set [Channel Mode] to [Diff]

In the Utility screen, set [Channel Mode] to [Diff] ([Indep] is normally set).

This sets the channel mode to differential output oscillation (DC is same polarity).

The frequency, phase, amplitude, and DC offset settings of both channels are the same and the reverse phase waveform is output. Even if settings are changed, the differential output relationship is kept.

This function performs control to keep the differential output relationship also during modulations or sweeps.

For the differential output oscillation, the setting can be set only for channel 1 (behaves as the oscillator for one-channel).

### ■ Operational restrictions

There are the restrictions shown in the following table to keep the differential output:

Item	Restriction
Modulation	Modulation source can be set to internal for FM, PM, AM, AM(SC), OFSM, and PWM. Modulation source can be set to internal or external for FSK or PSK.
Sweep Oscillation Mode	Gated single sweep is not used. External trigger source is valid only for CH1.
Burst Oscillation Mode	Cannot be used.
External addition	Cannot be used.

## 8.9 Obtaining Double Output Voltage (2-Channel Coordination: Diff2)

With respect to the AC signal component, this is the same as [Diff] (differential) in the previous section.

The DC offset setting is reversed polarity with channel 1 and channel 2.

When the hot sides of CH1 and CH2 are used as the output, including DC, it is possible to obtain double the amount of output voltage (however, the output impedance is 100  $\Omega$ ).

### ■ Selecting 2-channel coordination

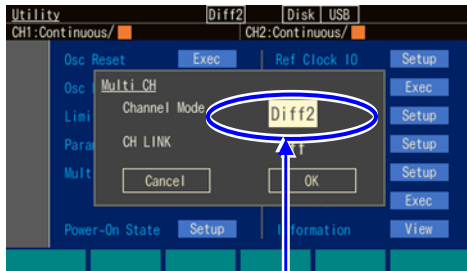

Set [Channel Mode] to [Diff2]

In the Utility screen, set [Channel Mode] to [Diff2] ([Indep] is normally set).

This sets the channel mode to differential output oscillation (DC is also reversed polarity).

The frequency, phase, and amplitude settings of both channels are the same and the reverse phase waveform is output. DC offset is also of reversed polarity. Even if settings are changed, the differential output relationship is kept.

This function performs control to keep the differential output relationship also during modulations or sweeps.

For the differential output oscillation, the setting can be set only for the channel 1 (behaves as the oscillator for one-channel).

### ■ Operational restrictions

The restrictions are the same as when the channel mode is [Diff].

## 9. Synchronizing Multiple Units

9.1	Connection Procedure.....	9-2
9.2	Performing Synchronization .....	9-4

Synchronizing multiple units of WF1983 and WF1984 allows you to configure up to 12-phase oscillators (when 6 units of WF1984). You can change the phase and amplitude for each phase independently.

Set the same frequency for all units and channels.

### 9.1 Connection Procedure

Here, the WF1983 or WF1984 that will be the synchronization reference is called the master unit. The other WF1983 and WF1984 are called slave units.

#### ■ Connectors to use

Use the external 10 MHz frequency reference input (10MHz REF IN) and frequency reference output (REF OUT) on the rear panel.

#### ■ Cables to use for connection

Cable type: Characteristic impedance 50  $\Omega$  series coaxial cable with BNC connector (RG-58A/U etc.).

Restriction to cable length: 1m or less between units, total cable length is 3m or less

#### ■ Connection method

There are two connection methods (connection method 1 and connection method 2).

If there are many units, using connection method 1 can reduce the time difference between slave units. However, in addition to the coaxial cable, a T-type divider and 50  $\Omega$  terminating resistor are required.

Connecting with connection method 2 is easy because connection using only a coaxial cable is possible. However, the time difference between the slave units is larger than that of connection method 1. The maximum number of units that can be connected is fewer than that of connection method 1.

Any of the built-in crystal oscillator or external 10 MHz clock can be used as the frequency reference for the master unit. If you use the external 10 MHz as the reference, the frequency of the slave unit will also be the same accuracy as the external reference.

#### · Connection method 1

Connect the reference output for the master unit to the reference inputs of the slave units in parallel using T-type dividers.

Use the 50  $\Omega$  terminating resistor for the reference input for the terminal slave unit.

The time difference between the slave units varies depending on the connection cable length (approximately 5ns/m).

A maximum of 6 units can be connected, including the master and slave units.

## 9.1 Connection Procedure

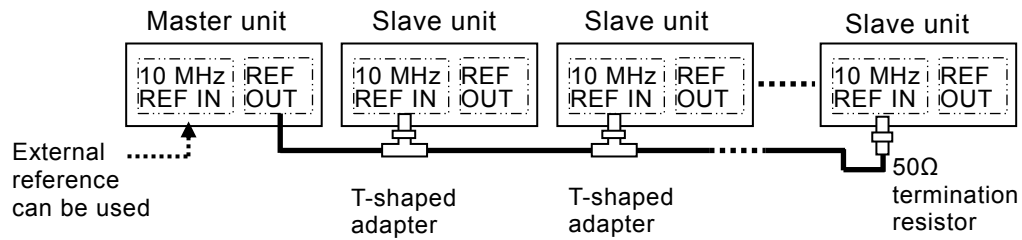

- Connection method 2

Connect the reference output for the master unit or slave unit to the reference input for the next slave unit.

The time difference between slave units varies depending on the delay within units (approximately 5ns) and connection cable length (approximately 5ns/m).

A maximum of 4 units can be connected, including master and slave units.

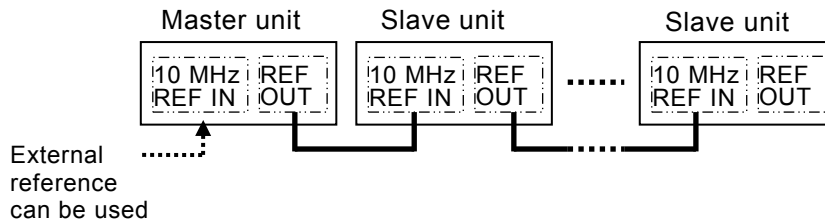

## 9.2 Performing Synchronization

### ■ Before synchronization

After connecting the master unit and slave units is finished, configure the settings as follows:

#### Master unit

- Select 2-channel independent operation or 2-phase operation (in the Utility screen, set the channel mode setting to [Indep] or [2Phase] (WF1984 only)).
- Enable the frequency reference output (in the Utility screen, set 10MHz Ref Out to [Enable]).
- Set the frequency for each channel to the frequency used for synchronous operation of multiple units.
- If you set the frequency reference for the master unit to external, enable the external frequency reference (in the Utility screen, set the external reference to [Enable]). [P.10-4](#)

#### Slave units

- Select 2-channel independent operation or 2-phase operation (in the Utility screen, set the channel mode setting to [Indep] or [2Phase] (WF1984 only)).
- Enable the external frequency reference (in the Utility screen, set the external reference to [Enable]). [P.10-4](#)
- Set the frequency for each channel to the frequency used for synchronous operation of multiple units (common to all units and channels).
- For connection method 2, enable the frequency reference output (in the Utility screen, set 10MHz Ref Out to [Enable]).

Set [Channel Mode] to [Indep] or [2Phase] (WF1984 only)

Set 10MHz Ref Out to [Enable]

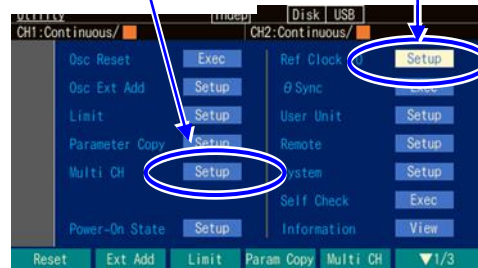

Set [Channel Mode] to [Indep] or [2Phase] (WF1984 only)

Set [Ext Reference] to [Enable]

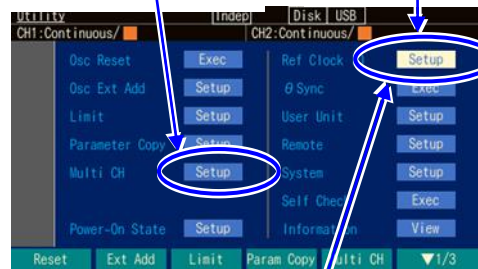

For connection method 2, set 10MHz Ref Out to [Enable]

## 9.2 Performing Synchronization

Check that all slave units operate based on the external frequency reference. If the [Ref] icon is lit without flashing on the status display area at the top of the screen, they operate based on the external frequency reference.

If they operate based on the external frequency reference, the [Ref] icon is lit without flashing

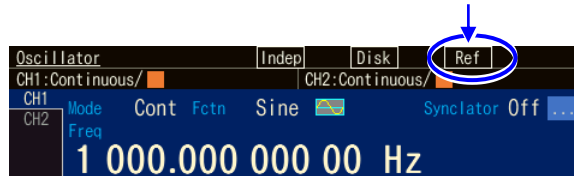

### ■ Performing synchronization

Synchronous operation is performed in the master unit. The following two methods are available to perform synchronous operation:

- Performing synchronous operation from a button in the Utility screen

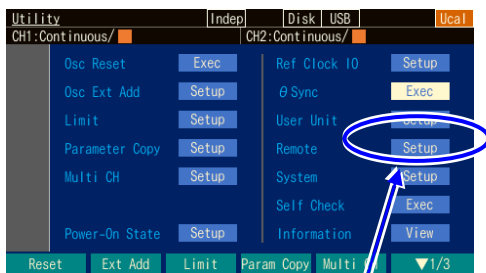

In the Utility screen, select [ØSync] and then press the ENTER key to execute the phase synchronization

The synchronous operation is performed in the Utility screen.

Select [ØSync] in the Utility screen, and then press the ENTER key. Alternatively, press and hold the TRIG key.

This runs the phase synchronization.

At this time, the phase will be discontinuous temporarily because all channels stop the oscillation once.

- Performing synchronous operation by pressing and holding down the TRIG key

Press and hold the TRIG key on the front panel for at least 1 second.

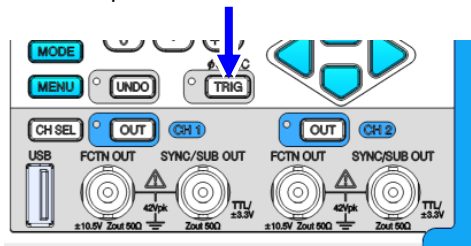

When the phase synchronization is run, a message is displayed on each unit.

### ■ Phase relationship after synchronous operation

The oscillation phase for each channel is initialized by the synchronous operation. The phase difference of the output waveform appears as the difference of the phase setting for each channel.

Even if synchronous operation is performed, the synchronization relationship will be lost if the frequency is changed later. Even if the synchronization relationship is lost, no message is displayed. Perform synchronous operation again.

The synchronization relationship is lost when the connection cable between the master unit and a slave unit or between slave units is disconnected. If you change the setting for the channel mode or external frequency reference, the synchronization relationship is lost.

### ■ Operational restrictions

There are the restrictions shown in the following table for synchronous operation. Even if the synchronous operation is invalid, performing the synchronous operation causes all channels to stop the oscillation once.

Item	Restriction
Waveform	Invalid for noise and DC
Modulation	Invalid for FM and FSK.
Sweep Oscillation Mode	Invalid for frequency sweep. Invalid for gated single sweep. The synchronization operation may not be performed correctly during sweep. Perform it during hold.
Burst Oscillation Mode	Invalid
Synclator Function	Invalid during synclator operation.



## **10. Using External Frequency Reference**

10.1	Purpose of Using External Frequency Reference .....	10-2
10.2	Connection and Usage Procedure of External Frequency Reference .....	10-2

## 10.1 Purpose of Using External Frequency Reference

This product uses a built-in crystal oscillator as the frequency reference, but you can also use an external 10 MHz clock as the frequency reference.

Generally, an external frequency reference is used for the following purposes:

- To use a frequency reference with a higher accuracy than that of the frequency reference built into this product to improve the accuracy and stability of the frequency.
- To use a frequency reference that is common to other units when wish the frequency accuracy to be common.
- To synchronize with other WF1983 or WF1984. For this synchronous operation of multiple units,

☞ P.9-2

## 10.2 Connection and Usage Procedure of External Frequency Reference

- To connect an external 10 MHz signal

Connect the external 10 MHz signal to the external 10 MHz frequency reference input (10 MHz REF IN) BNC terminal on the rear panel.

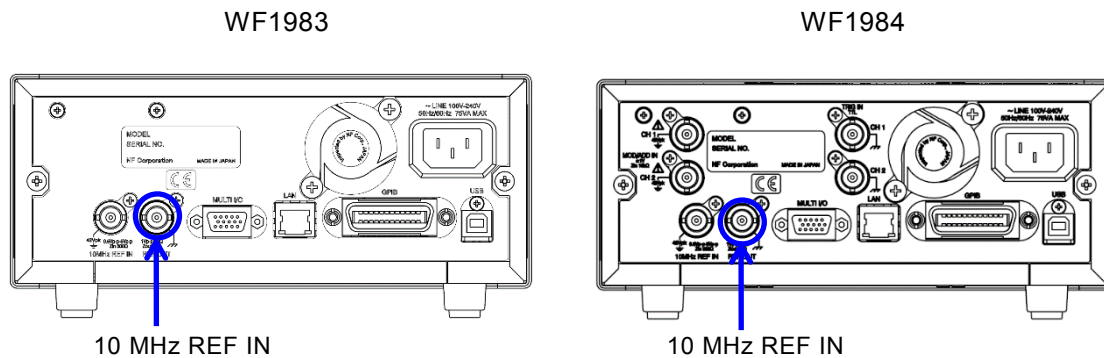

Input characteristics are as follows:

Input voltage	0.5 Vp-p to 5 Vp-p
Maximum allowable input	10 Vp-p
Input impedance	300 Ω, unbalanced, AC coupled
Input frequency	10 MHz (±0.5% (±50 kHz))
Input waveform	Sine or square wave (50±5% duty)
Signal GND	Insulated from the enclosure and each channel waveform output (maximum 42 Vpk)

If reflection is a problem, use the terminating resistor since the input impedance is not 50 Ω.

The signal ground of the external 10 MHz frequency reference input is insulated from the enclosure. Therefore, noise caused by ground-loop does not affect the connection with a frequency standard.

Nor does noise caused by ground-loop affect the connection even when synchronously connecting multiple units of WF1983 and WF1984.

## 10.2 Connection and Usage Procedure of External Frequency Reference

---

Note that, in all cases, the floating voltage should be limited to 42 Vpk (DC + AC peak) or lower to prevent electric shocks.

For cautions on the floating ground connection, see "3.3 Cautions on Floating Ground Connection".

---

### **WARNING**

To prevent electric shocks, do not apply a voltage exceeding 42 Vpk (DC + AC peak) between the ground of the BNC connectors insulated from the enclosure and the enclosure.

Also, do not apply a voltage exceeding 42 Vpk (DC + AC peak) between the grounds of the BNC connector groups insulated from the enclosure. "BNC connector groups" used here, indicates multiple BNC connectors that are connected to a common ground.

If such a high voltage is applied, the internal voltage limiting elements will try to reduce the voltage, but a voltage that is too high may cause the product to burnout.

---

---

### **CAUTION**

If a difference in potential exists between the ground of a BNC connector insulated from the enclosure and the enclosure, do not short-circuit the hot side of that BNC connector and the enclosure. This may damage the product.

---

---

### **CAUTION**

If a difference in potential exists between the grounds of BNC connectors, do not short circuit these BNC connector grounds. This may damage the product.

---

### ■ Enabling external frequency reference

You can enable/disable the external frequency reference in the Utility screen.

In the Utility screen, select [Ref Clock IO] and then press the ENTER key to display a dialog box. Select the 10 MHz Ref In setting in the dialog box, press the ENTER key to open the selection list, and switch from [Disable] to [Enable] to enable the external frequency reference.

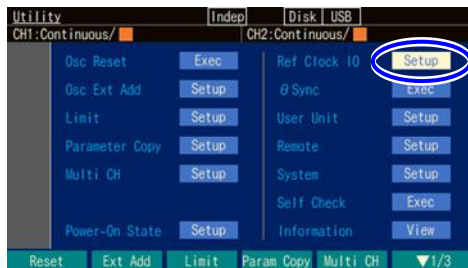

In the Utility screen, select [Ref Clock IO] and then press the ENTER key

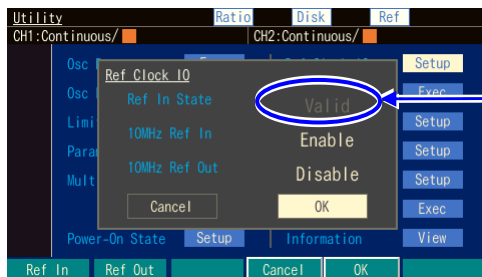

If the available frequency reference is entered, [Valid] is displayed in the [10MHz Ref In] field. Otherwise, [Invalid] is displayed.

If the 10MHz Ref In setting of [Ref Clock IO] is [Enable] and the status of [10MHz Ref In] is [Valid], then this product operates using the signal input to the external 10 MHz frequency reference terminal as the frequency reference.

However, if the external frequency reference signal is interrupted during processing, the frequency reference is automatically switched to the built-in frequency reference. After that, if the external frequency reference signal is restored, this product will resume operation using it as the frequency reference.

What is used as the frequency reference is always displayed on the status display area at the top of the screen.

If the current frequency reference is external, the [Ref] icon is displayed.  
If the status of reference input is [Invalid], the icon flashes.



# 11. Using Sequence Oscillation

11.1	Sequence Oscillation .....	11-2
11.2	Sequence Oscillation Example .....	11-2
11.3	Basics .....	11-4
11.4	In-Step Processing Flow .....	11-12
11.5	Setting and Operation Procedure .....	11-13
11.6	Saving Created Sequence .....	11-18
11.7	Using the Saved Sequence .....	11-20
11.8	File Operations .....	11-22
11.9	Outline of Screen .....	11-25
11.10	Individual Descriptions of Step Control Parameters .....	11-26

## 11.1 Sequence Oscillation

Sequence oscillation is the operation to output while automatically changing the amplitude, frequency, and other parameters according to a predetermined procedure.

For example, sequence oscillation can be used to output a triangle wave of 2 kHz and 2 Vp-p immediately after a sine wave of 1 kHz and 1 Vp-p has been output. In addition, repeating a specified number of times and branching according to the inputs of external signals are also possible.

For details, see P.11-4.

## 11.2 Sequence Oscillation Example

As a simple example of sequence oscillation, this section describes how to build a sequence to change DC voltage in three stages as shown in the following figure. The setting details are shown in Table 11-1.

The operation is described in step transition order on the next page.

(First, restore the initial setting in the Utility screen.)

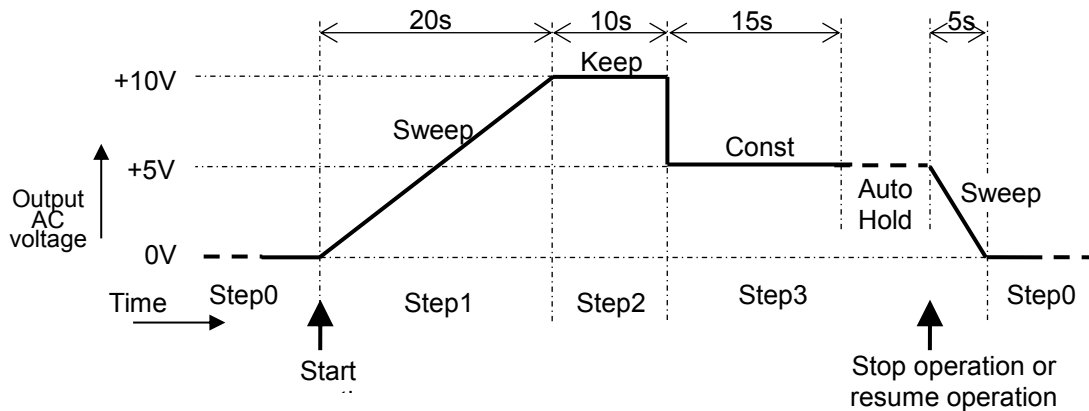

Table 11-1 Sequence setting details

Step number Step	Step control parameters AutoHold, JumpTo, Count, etc.		Intra-step channel parameters Fctn, Freq, Amptd, etc.
0	Time:5s	StopPhs:Off value StepCode: Any	Fctn:DC Offset:0V Action:Sweep
1	Time:20s	AutoHold:Off StopPhs:Off StateB:Off EventB:Off value JumpTo:Off StepTerm:Continue StepCode: Any	Fctn:DC Offset:+10V Action:Sweep
2	Time:10s	AutoHold:Off StopPhs:Off StateB:Off EventB:Off value JumpTo:Off StepTerm:Continue StepCode: Any	Fctn:DC Offset: ---- Action:Keep
3	Time:15s	AutoHold:On StopPhs:Off StateB:Off EventB:Off value JumpTo:Off StepTerm:End StepCode: Any	Fctn:DC Offset:+5V Action:Const

### Step 0

These are the special output settings for transitioning before the sequence begins and when the sequence ends.

In this example, the system waits for the sequence to start in the state of 0 V DC.

[Time] and [Action] of Step 0 are enabled only when the sequence ends, and have no meaning here. They will be explained later.

### Step 1

When the sequence starts, the sequence goes to Step 1.

Since [Time] is set to 20 seconds, [Offset] is set to +10 V, and [Action] of [Offset] is set to [Sweep], the output voltage rises linearly from 0 V to +10 V over 20 seconds.

Once the output voltage has reached +10 V after 20 seconds, since [StepTerm] is set to [Continue], the sequence moves on to the next step, Step 2.

### Step 2

Since [Time] is set to 10 seconds and [Action] of [Offset] is set to [Keep], the last value of the previous step, Step 1, which is +10 V, is held for 10 seconds.

After the lapse of 10 seconds, since [StepTerm] is set to [Continue], the sequence moves on to the next step, Step 3.

### Step 3

Since [Time] is set to 15 seconds, [Offset] is set to +5 V, and [Action] of [Offset] is set to [Const], a constant value, which is +5 V, is held for 15 seconds. When the sequence moves on from Step 2 to Step 3, the output voltage abruptly changes from +10 V to +5 V.

After the lapse of 15 seconds, since [AutoHold] is set to [On], the sequence goes into standby in that state.

After that, when the stop operation is performed, the sequence moves to Step 0.

Since [StepTerm] is set to [End], the sequence moves to Step 0 even if the resume operation is performed.

Note that if [StepTerm] is set to [Continue], the sequence moves to Step 4 when the resume operation is performed.

### Step 0

Since [Time] is set to 20 seconds, [Offset] is set to 0 V, and [Action] of [Offset] is set to [Sweep], the output voltage rises linearly from +5 V to 0 V over 20 seconds.

Once the output voltage has reached 0 V after 5 seconds, the sequence goes into standby in that state.

When the start operation is performed at this point, the same sequence is repeated.

## 11.3 Basics

This section describes the necessary information you should know when using the sequence oscillation.

### a) Difference between sequence oscillation and normal oscillation

During sequence oscillation, the unit operates on individual waveform, frequency, and amplitude settings, which are independent from normal oscillation (continuous, modulated, sweep, and burst). Even if you switch between sequence oscillation and oscillator, the setting values of each of them will be retained.

### b) Step control parameters and intra-step channel parameters

Sequence oscillation has the following two main types of parameters.

- Step control parameters

Sequence oscillation consists of multiple steps linked to each other. The step flow is controlled by the step control parameters. These parameters determine the step duration time and the next step. For convenience, the step synchronization code output setting is also included in the step control parameters.

For details, see “11.11 Individual Description of Step Control Parameters.”

- Intra-step channel parameters

This parameter determines the output status within each step. Along with basic parameters, such as waveform, frequency, and amplitude, it determines how these parameters change within each step.

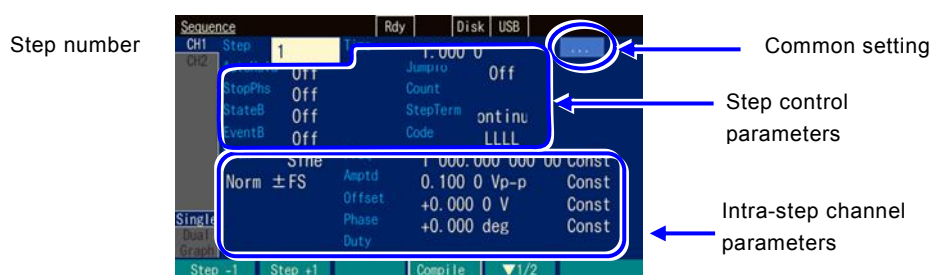

### c) Intra-step parameter change pattern

The intra-step channel parameters, except for waveform, can be changed within steps. There are the following three ways of doing this. These are called action settings. In the case of waveform parameters, there is no action setting. Instead, the setting is always done in that step.

- Constant [Const]

The value is fixed to that setting specified in the step.

- Keep [Keep]

The value immediately before the move to that step is maintained. This means, the value changes according to the status of the previous step.

When the action setting is set to [Keep], you will not be able to set the parameter value.

In step #0, [Keep] cannot be selected.



- Sweep [Sweep]

The value changes linearly over the step time from the value immediately before to the value set in that step. This means that the set value is reached when the step time of that step has elapsed. The starting value changes according to the status of the previous step.

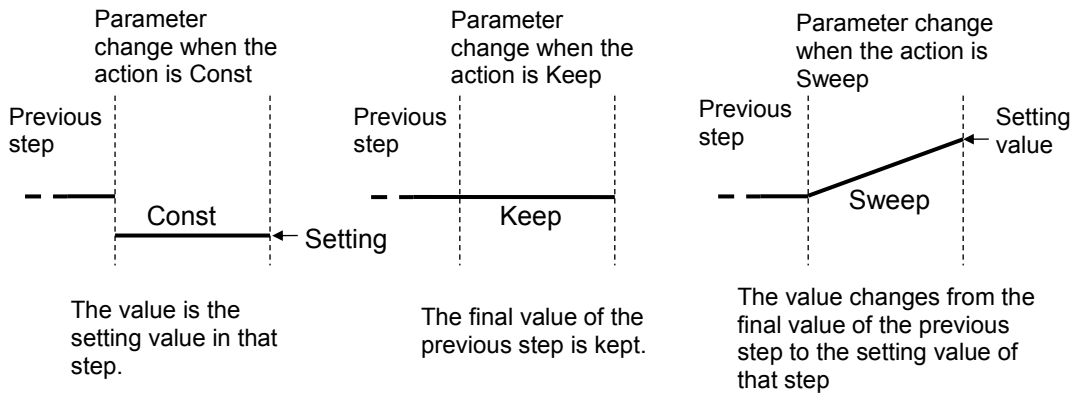

**d) Phase during sequence oscillation**

With sequence oscillation, the reference phase is generated inside the unit and then the reference phase with the value set in [Phase] added to it is output. The reference phase changes continuously even if the frequency / amplitude / offset / phase changes. With the exception of an arbitrary waveform, DC, or noise, it changes continuously even if the waveform changes. The reference phase resumes from 0° immediately after the arbitrary waveform, DC, or noise has been output.

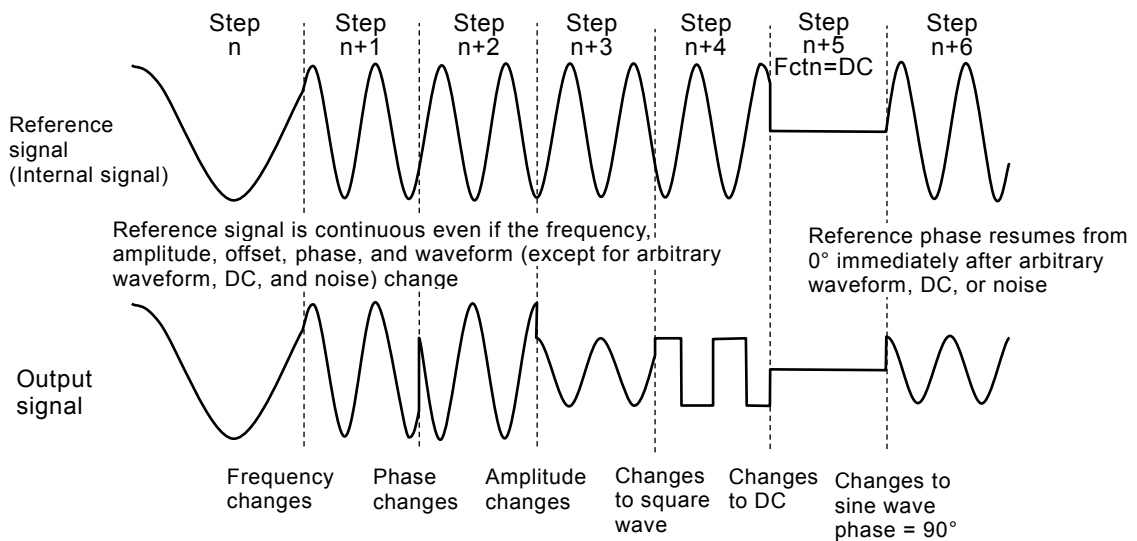

e) Phase at step end [StopPhs]

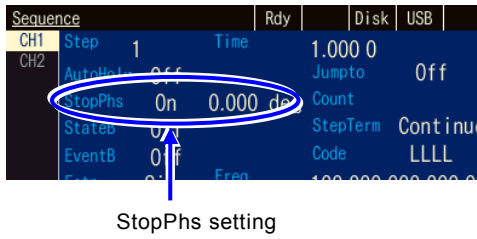

Normally, when the prescribed step time has elapsed, the sequence moves on to the next step regardless of the reference phase. However, if you wish to set the sequence to move on to the next step after the completion of one cycle of waveform, it is possible to specify the end phase (stop phase).

However, with WF1984, operation is with respect to the phase of channel 1. The stop phase cannot be set for channel 2. In addition, when the waveform is a square wave, noise, or DC, it is not possible to specify the stop phase. With an arbitrary waveform, it can only be with the phase set in [Phase] regardless of the setting of [StopPhs].

When the stop phase is specified, after the lapse of the prescribed step time, the sequence moves on to the next step when the specified reference phase has been reached, with the output setting maintained as is (sweep is not performed during this interval). As a result, the actual step time is longer than the specified step time. The sequence moves on to the next step with a continuous phase regardless of the stop phase setting.

The following figure shows examples in which the stop phase is specified and in which it is not specified when the phase between steps is changed quickly. These are examples when the phase setting value and stop phase setting value are both set to 0° in the previous step and 90° in the next step, and the stop phase is set to 45°. In both cases, the reference phase is continuous at the transition of the steps. When StopPhs is On, the sequence proceeds to the next step when the reference phase is equal to the set value.

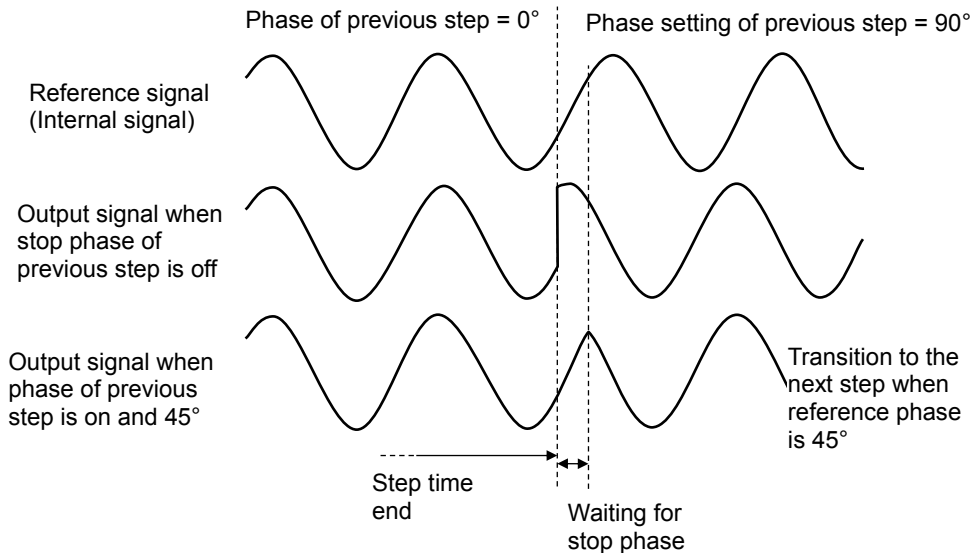

Similarly, the following figure shows examples in which the stop phase is specified and in which it is not specified when the amplitude is changed quickly. These are examples when the phase setting value and stop phase setting value are both  $0^\circ$ . In both cases, the phase is continuous at the transition of the steps.

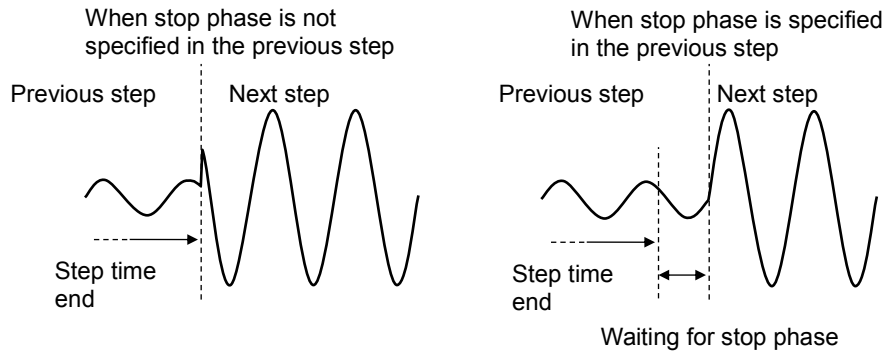

**Check**

- The stop phase setting cannot be set for a square wave, noise, and DC.
- With arbitrary waveforms and parameter-variable waveforms, the oscillation start phase is fixed.
- The sequence changes to the next step after approximately 350 ns (equivalent to  $0.126^\circ$  at 1 kHz) has elapsed from the specified stop phase.

**f) Phase at step start**

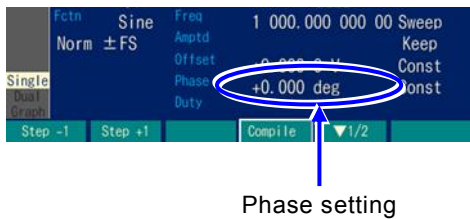

If the waveform of the previous step was an arbitrary waveform, DC, or noise, oscillation in the next step starts from reference phase  $0^\circ$ .

Phase  $0^\circ$  here is the phase value based on the reference phase as in the case of the phase at step end (stop phase). The start phase that appears in the actual output is the phase setting value of that step. If the phase is set to  $0^\circ$ , oscillation starts from  $0^\circ$ .

The following figures show examples of when the phase is set to  $0^\circ$  and when the phase is set to  $90^\circ$ , where the step after DC is sine wave.

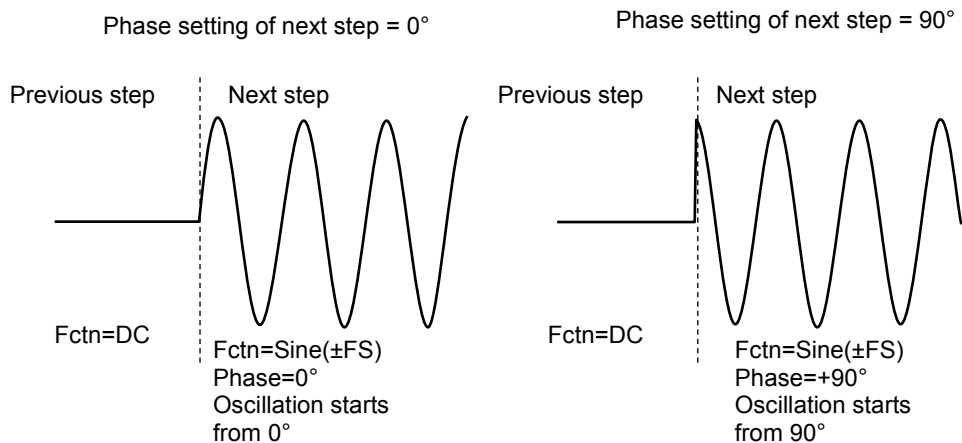

### ✓ Check

When you wish to specify the start phase, set the previous step to DC.

#### g) Frequency during DC or noise waveform output

If the action of frequency is set to Sweep in the next step of DC or noise, the sweep begins from 1kHz in the next step.

#### h) Two types of branches

The control flow can be changed by the panel operation or by the external signals. This is called branching. For example, branching can be used to set the sequence to move to a different step in response to a status change of the equipment under test.

There are two types of branches as follows:

- State branch [StateB]

The operation branches to the specified step according to a signal from a multi-I/O connector (pin 14). [P.11-10](#)

However, the signal from the multi-I/O connector is checked only after the step time of that step has elapsed (excluding the time that held). [P.11-12](#)

- Event branch [EventB]

The operation branches immediately to the specified step according to the soft key operation or the signal from a multi-I/O connector (pin 11). Even if the stop phase has been set, it is ignored.

However, when a jump is made to step number 0, time is required because the parameters of the step are recalculated. If multiple event branches will be input, a signal without chattering should be input because time is required for internal processing code transfer. This function can be used for processing such as save processing when an abnormality is detected.

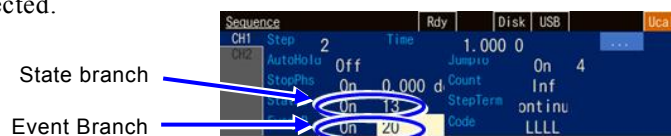

#### i) Step 0 before the start and at the end

The step in a standby state before the start of sequence is called Step 0. Step 0 is also the state at the end of the sequence. When the mode changes from the normal oscillation mode (Oscillator) to sequence oscillation, the status changes to the Step 0 output status.

Since this is a special step, the items that can be set to the step control parameters and their meanings are different from those of other steps.

Only the following three items can be set for the step control parameters.

- Step time: At the start of the sequence, the sequence changes to the next step (normally Step 1) without waiting for this time. The step time is enabled when parameters are swept at the sequence end. When sweep is set in the intra-step channel parameter setting of Step 0,

sweeping is performed for the duration of this time. <sup>ESP</sup> P.11-4

- Stop phase: At the start of the sequence, the sequence waits for the reference phase specified here and then moves to the next step (normally Step 1). This setting is disabled for a square wave, arbitrary waveform, noise, and DC.
- Step synchronization code output: This is the step synchronization code output of Step 0.

The action setting of intra-step channel parameters consists of [Const] (constant) and [Sweep] (sweep) only. It does not include [Keep] (keep). This means, the same output setting is always applied to the start and the end.

**j) Limitation of available waveform**

The waveforms that can be used for sequence oscillation are limited to sine wave, square wave (both standard and extended duty variable range), noise, DC, and arbitrary waveform.

When you wish to use a ramp wave or parameter-variable waveform, copy the desired waveform to the arbitrary waveform and save it as an arbitrary waveform in advance in the ARB Edit screen. During sequence oscillation, it is not possible to specify the symmetry of ramp wave or the parameters of the parameter-variable waveform.

When you wish to use a pulse waveform, save the half sine edge pulse of the parameter-variable waveform as an arbitrary waveform.

**k) Waveform size**

With sequence oscillation, all of the waveforms to be used are saved to the 64 MiW waveform memory in advance. Therefore, when many types of waveforms are used, the memory size allocated to one waveform becomes smaller.

However, the waveform memory is not used for DC, sine wave, and square wave (regardless of whether the duty variable range is standard or extended). In addition, the required memory size does not change when the same waveform is used repeatedly.

Beware of the following points:

- When the memory size that can be allocated becomes smaller, an arbitrary waveform in control point format with many abrupt changes may lose its characteristics.
- When a large arbitrary waveform in array format is used, the memory size that can be allocated to other waveforms becomes smaller.

The following table shows the memory size that can be allocated to each waveform.

Waveform	Size	Size adjustment
DC	0W	Fixed
Square wave	0W	Fixed
Sine wave	0W	Fixed
Noise	65728W	Fixed
Arbitrary waveform (control point format)	Automatically converted to 16 KiW to 1 MiW	Variable
Arbitrary waveform (array format)	Extended to multiple of 32 W	Fixed

When a parameter-variable waveform, square waveform, pulse waveform, or ramp waveform is copied to an arbitrary waveform, it becomes an arbitrary waveform in control point format.

Noise is always used in a memory size of 65 728W. The size is fixed. However, this does not mean that the same pattern is repeated during output.

For an arbitrary waveform in array format, the waveform size transferred from the USB flash memory or external control is extended to a multiple of 32 W.

For an arbitrary waveform in control point format, the size is allocated within the range of 16 KiW to 1 MiW according to the frequency for each step. The waveforms of steps with the same waveform length are used commonly. If 16 KiW cannot be secured, an insufficient memory error occurs.

The arbitrary waveforms in the control point format are not simply thinned but expanded to the memory in such a way that the characteristics of the waveforms are maintained as much as possible.

#### l) Channel coordination (WF1984 only)

The step control parameters are common to both channels. The sequence makes the same step transition for both channels. However, since the stop phase can be controlled only by the channel 1 side, the stop phase of channel 2 does not necessarily match the desired value.

On the other hand, the intra-step channel parameters can be set independently for each channel.

#### m) Common settings for sequence

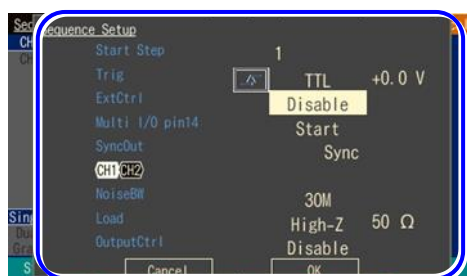

Select [Setup] and then press the ENTER key to open the window for common settings.

The following items are common settings within one sequence.

- Start step [Start Step]  
The number of the next step, to which the sequence moves to after Step 0, can be specified. Usually, this is set to 1.
- External trigger polarity [Trig]  
When using the external trigger input (BNC terminal) as the sequence start trigger, its polarity and threshold can be specified. When it is not used, set this item to Off. With WF1984, only the trigger input terminal on the channel 1 side is enabled.
- External control [ExtCtrl]  
Enable this item to control the start, stop, hold/resume, and branch of the sequence by using the signal from the multi-I/O connector (set to [Enable]). When the multi-I/O connector is not used, disable this setting (set to [Disable]). ☞ P.11-16
- Allocation of pin 14 of multi-I/O connector [Multi I/O pin14]  
Pin 14 of the multi-I/O connector can be allocated either to the sequence start (set to [Start]) or to the state branch (set to [StateBranch]). ☞ P.11-16
- Synchronization output [SyncOut]  
This selects whether to output the waveform synchronization signal (set to [Sync]) or LSB (set to [StepCode (LSB)]) of the step synchronization code to the synchronization/sub-

output terminal. For the step synchronization code, see P.11-27.

If LSB of the appropriate step synchronization code is set to H and output, it can be used as the trigger source to enable a simplified check of the sequence to be executed with an oscilloscope. For multi-I/O connector, see P.3-13.

When a noise waveform is selected for a step in the sequence, set its noise bandwidth.

- Noise bandwidth [NoiseBW]
- Load resistance [Load]

Set the load resistance value in the sequence mode.

- Output control [OutputCtrl]

Set waveform output (FCNT OUT) in the sequence mode to on/off.

When this setting is [Enable], on/off of waveform output (FCNT OUT) changes under the following conditions. This is the current setting when editing.

- When transitioned to the "executing state," waveform output (FCNT OUT) turns on.
- When transitioned to the "execution wait state," waveform output (FCNT OUT) turns off.

Output control by normal [OUT] key operation is always enabled regardless of this setting.

### n) Other limitations

- The amplitude range is automatically determined according to the maximum output level of the overall sequence. During sequence execution, range switching does not occur.
- The external addition function is forcibly set to off.
- For the amplitude and DC offset load impedance conditions, the values set on the oscillator screen are used.
- With WF1984, only one of the channels cannot be set to perform sequence oscillation.
- The stop phase of an arbitrary waveform can be only 0°.
- The phase of a parameter-variable waveform and arbitrary waveform cannot be changed.

## 11.4 In-Step Processing Flow

The following figure shows the flow of processing within one step.

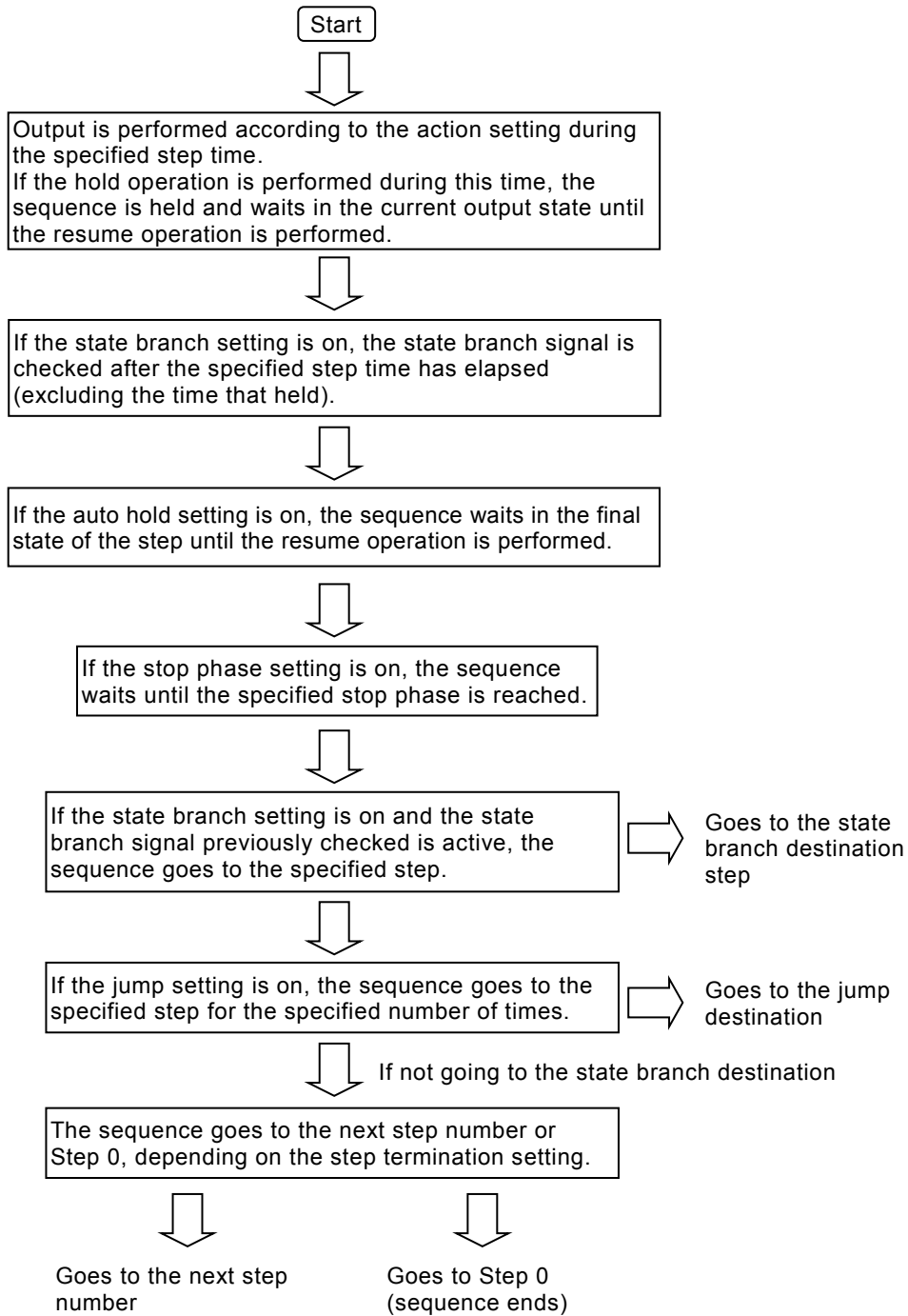

The following transitions occur as a result of event branching or termination operation, regardless of the flow in the step.

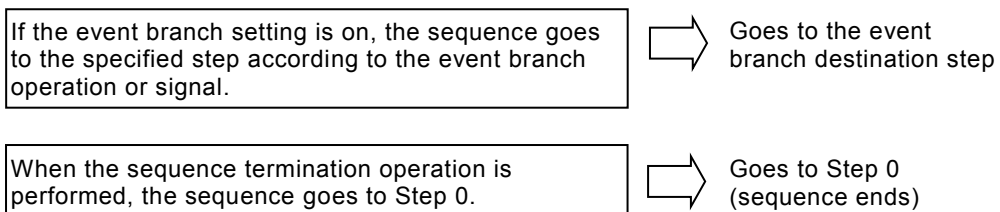



## 11.5 Setting and Operation Procedure

Create and edit a sequence in sequence oscillation.

### a) To switch to sequence oscillation

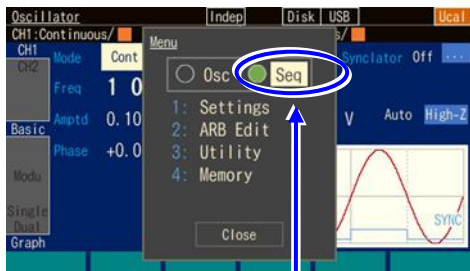

In the top menu, select [Seq] and then press the ENTER key

1. Press the MENU key to open the top menu window. Then, select [Seq] and press the ENTER key.
2. The dialog box to confirm the move to sequence oscillation is displayed. Select [OK] and then press the ENTER key. This will move to sequence oscillation. The sequence creating/editing window is displayed with the output setting for Step 0.

### b) To create/edit a sequence

To create a new sequence, configure the settings step by step.

The copy soft key and paste soft key allow you to reuse existing settings. The parameters that can be copied and pasted are step control parameters and intra-step channel parameters.

During editing, the waveform of the selected step is output to the waveform output.

In the sequence creating/editing screen, [Edit] is displayed at the top right corner of the screen.

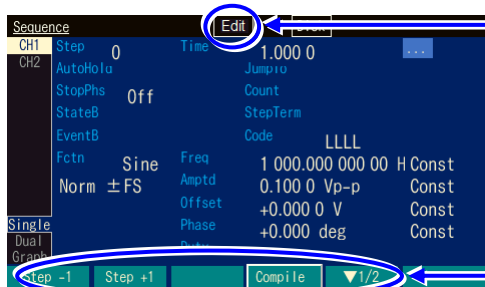

In the creating/editing screen, Edit is displayed.

The soft keys are made up of two rows.

The soft key items in the sequence creating/editing screen are as follows:

#### Soft keys in [Edit] state

First row (Single and Dual screens)



This indicates the first row

Go to the previous or next step number with [Step +1] or [Step -1].

Make the sequence executable with [Compile].

First row (Graph screen)



Go to the previous or next step number with [Step +1] or [Step -1].

Adjust the vertical-axis scale of graph display so that the scale does not become saturated with [AutoScale].

Make the sequence executable with [Compile].

Second row (Single and Dual screens)



Step parameters (both step control parameters and intra-step channel parameters) corresponding to the step number currently displayed can be copied and pasted, or the step itself can be cut and inserted. Even when a step is cut and inserted, the step numbers referenced in each step (jump destination and branch destination) are not changed.

Intra-step channel parameters of the currently displayed step number can be deleted, copied, and pasted with [Cut], [Copy], and [Paste]. With WF1984, these soft keys function on the active channel.

**c) To prepare for sequence execution**

Just recalling or creating/editing a sequence does not make the sequence executable.

When the [Compile] (compilation) soft key is pressed in the [Edit] state, the settings are checked to determine whether they are appropriate, the waveform data is allocated, and the optimum output range settings are configured to make the sequence executable (Ready).

If any setting that is inappropriate for execution is found as a result of compilation, an error message is displayed.

When compilation ends successfully and the sequence becomes executable, [Rdy] is displayed at the top right corner of the screen.

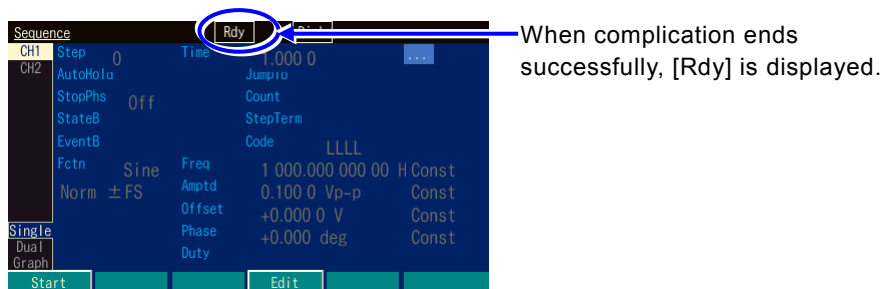

The soft key items in this state are as follows:

**Soft keys in [Rdy] state**



Start sequence execution with [Start].

Return to the creating/editing sequence screen with [Edit].

The created or edited sequence will be cleared when the power is turned off, so save the sequence if it is needed. Press the [Store] soft key in the [Edit] state to open the save settings window. The sequence can be saved either before or after the [Compile] operation (only in the [Edit] state).

**d) To execute the sequence**

Press the [Start] soft key in the [Rdy] screen to start sequence execution.

When the sequence begins, [Run] is displayed at the top right corner of the screen.

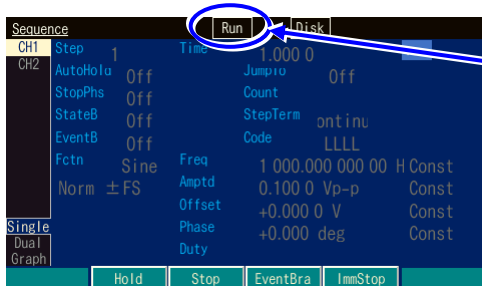

When the sequence begins, [Run] is displayed.

The soft key items in this state are as follows:

**Soft keys in [Run] state**



**e) To pause sequence execution**

Press the [Hold] soft key in the [Run] state to pause the sequence. The sequence goes into standby while keeping the output condition as is. To resume the sequence, press the [Resume] soft key in the [Hold] state.

In the hold state, [Hold] is displayed at the top right corner of the screen.

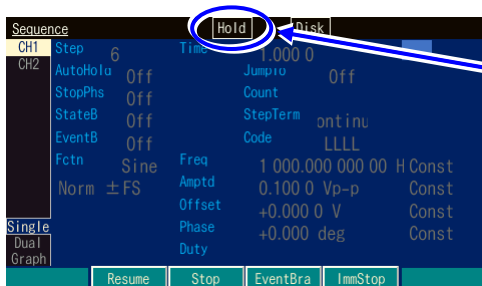

In the hold state, [Hold] is displayed.

The soft key items in this state are as follows:

**Soft keys in [Hold] state**



**f) To execute an event branch**

Press the [EventBra] soft key in the [Run] or [Hold] state to execute an event branch. If the event branch is set to on in the step which is being executed at that moment, the sequence moves to the specified step.

**g) To terminate the sequence**

Press the [Stop] soft key in the [Run] or [Hold] state to terminate the sequence. The sequence moves to Step 0.

[Rdy] is displayed at the top right corner of the screen. The sequence can be restarted at any time.

**h) To forcibly terminate the sequence without waiting for the stop phase or sweep**

Press the [ImmedStop] soft key in the [Run] or [Hold] state to immediately terminate the sequence without waiting for the stop phase or sweep execution. The setting switches to Step 0.

**i) To edit the sequence again**

Press the [Stop] soft key in the [Run] or [Hold] state to terminate the sequence. When it has terminated, press the [Edit] soft key in the [Rdy] state to enable creating and editing the sequence again.

To execute the sequence, press the [Compile] soft key in the [Edit] state again.

**j) To return to normal oscillation mode (Oscillator)**

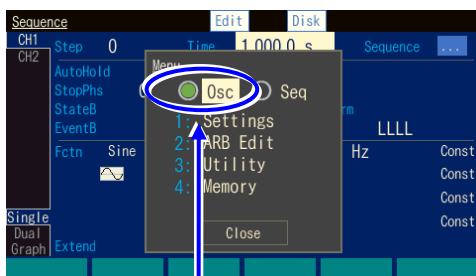

In the top menu, select [Osc] and then press the ENTER key

1. Pressing the MENU key displays the top menu window. Then select [Osc] and press the ENTER key.

2. The dialog box to confirm the move to the sequence oscillation is displayed. Select [OK] and press the ENTER key.

This will move to the sequence oscillation. The sequence creating/editing window is displayed with the output setting for Step 0.

**k) To control starting, stopping, and pausing of the sequence by using an external logic signal**

When the external control [ExtCtrl] in the common settings is set to [Enable], the sequence operation can be performed by TTL level logic input to the multi-I/O connector on the rear panel. P.11-10

It is recommended that this be set to [Disable] when not using an external control signal in

order to avoid malfunctions caused by exogenous noise.

For the multi-I/O connectors and their pin allocation, [☞ P.3-13](#)

During external trigger input (BNC terminal), only the sequence start operation can be performed. [☞ P.11-10](#)

The following operations can be performed.

■ **Starting a sequences**

Falling input in the [Rdy] state starts a sequence. This is disabled in the [Run] or [Hold] state.

■ **Stopping a sequences**

Falling input in the [Run] or [Hold] state ends the sequence and switches to Step 0.

■ **Holding/resuming sequences**

Falling input in the [Run] state pauses the sequence. Rising input during a pause or in the [Hold] state resumes the sequence from where it was paused.

■ **Event branch of the sequence**

When a step with an event branch on is being executed in the [Run] or [Hold] state, an event branch will be generated by falling input. The sequence changes to the specified event branch destination step.

■ **State branch of the sequence**

When a step with a state branch on is being executed in the [Run] or [Hold] state, a state branch will be generated by a low-level input. The sequence changes to the specified state branch destination step. For the timing to check the low-level input, [☞ P.11-12](#).

It is not possible to control both the sequence start and the state branch via the multi-I/O connector ([☞ P.11-10](#)). When using the multi-I/O connector for the state branch, use the external trigger input (BNC terminal) for the sequence start operation.

## 11.6 Saving Created Sequence

### 11.6.1 Saving to Internal Memory

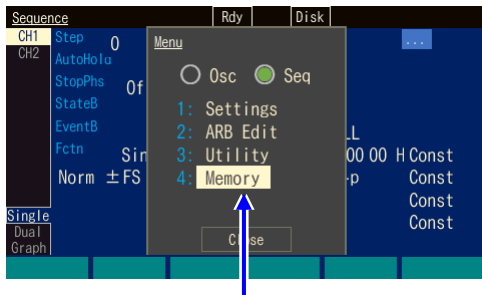

In the top menu,  
Select [Memory]

1. When the MENU key is pressed, the top menu opens. Then, select [Memory]. This opens the Memory screen.

Enter the sequence memory number of the save destination here.

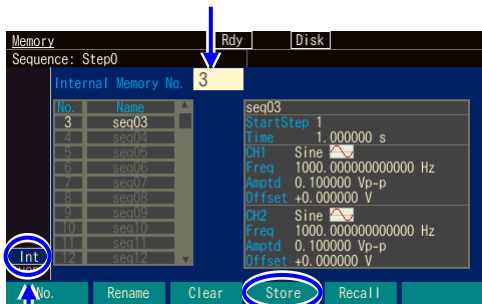

Select [Int] and  
press the  
ENTER key to  
save to internal  
memory.

Press the  
[Store] soft key

2. To save to the unit's internal memory, select the Int tab at the bottom left of the screen, and then press the ENTER key.

Select the [Internal Memory No.] field at the top left of the screen, and then press the ENTER key to open the input field of the sequence memory number of the save destination.

Use the up/down arrow keys or the modify knob to increment or decrement the memory number. The specified memory number and its setting name are highlighted on the left side of the screen.

An overview of the sequence saved to the specified memory number is displayed on the right side of the screen.

Select the memory number of the save destination, and then press the ENTER key to close the input field for the memory number.

The dialog box to  
confirm the save  
operation is opened.

You can change  
the name here.

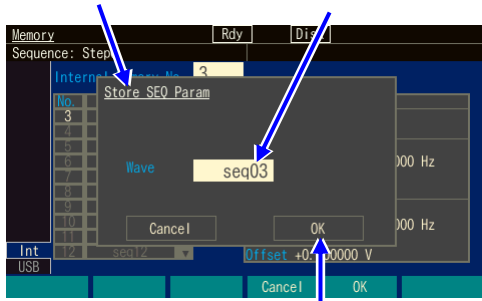

Select [OK] and then  
press the ENTER key  
to save.

3. Press the [Store] soft key to open the dialog box to confirm the save operation.

If you wish to save, select [OK], and then press the ENTER key. Saving is performed and the data previously saved to that sequence memory number is overwritten.

11.6.2 Saves to USB Flash Memory

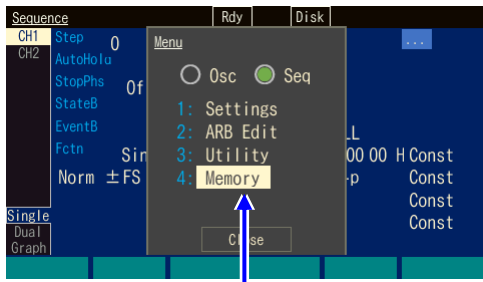

In the top menu, Select [Memory]

1. When the MENU key is pressed, the top menu opens. Then, select [Memory]. This opens the Memory screen.

Select the USB tab  
Press this button to create a folder.

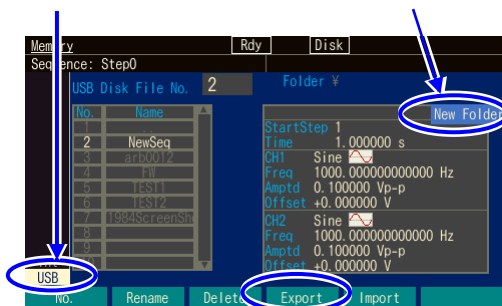

Press [Export] soft key.

2. Select the USB tab at the bottom left of the screen and then press the ENTER key to set the save destination to USB flash memory.

Folders have "¥" at the end of the name. When a folder is selected, pressing the [Enter] soft key moves to the specified folder (selecting ".¥" moves one folder up).

To create a new folder, select the [NewFolder] button and then press the ENTER key. The dialog box for entering a folder name is displayed. Enter the name and then press the [OK] soft key.

A dialog box for saving is displayed.

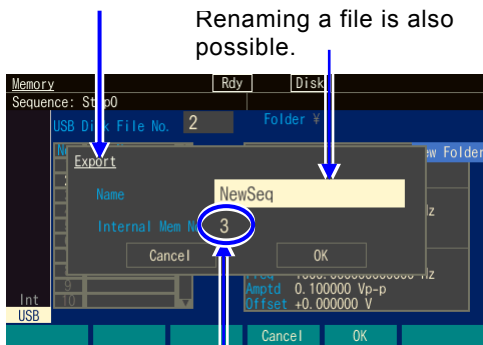

Select the sequence data in the save source.

3. Press the [Export] soft key to display the dialog box for saving. Specify a file name in the [Name] field and specify the sequence data of the copy source in the [Internal Mem Num] field. Press the ENTER key to save to USB flash memory.

## 11.7 Using the Saved Sequence

### 11.7.1 To Retrieve from Internal Memory

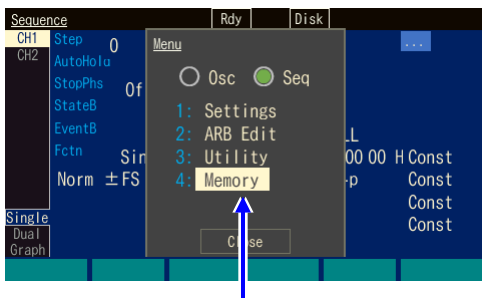

In the top menu, select [Memory]

1. When the MENU key is pressed, the top menu opens. Then, select [Memory]. This opens the Memory screen.

Enter the sequence memory number of the recall source here.

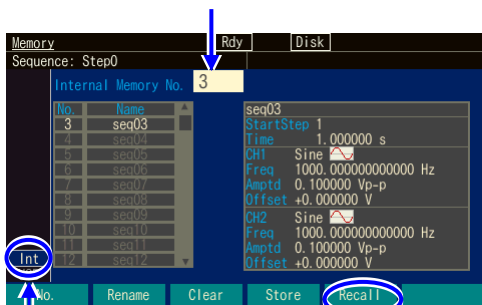

Select [Int] and press the ENTER key to save to built-in memory.

Press the [Recall] soft key to recall the sequence data.

2. When loading from the unit's internal memory, select the Int tab at the bottom left of the screen and then press the ENTER key.

Select the [Internal Memory No.] field at the top left of the screen, and then press the ENTER key to open the input field for the sequence memory number of the recall source.

Use the up/down arrow keys or the modify knob to increment or decrement the memory number.

The specified memory number and its setting name are highlighted on the left side of the screen.

An overview of the settings saved in the specified setting memory number is displayed on the right side of the screen.

Select the memory number of the recall source and then press the ENTER key to close the input field for the memory number.

3. Press the [Recall] soft key to recall the contents of the selected sequence memory number.



11.7.2 To Retrieve from USB Flash Memory

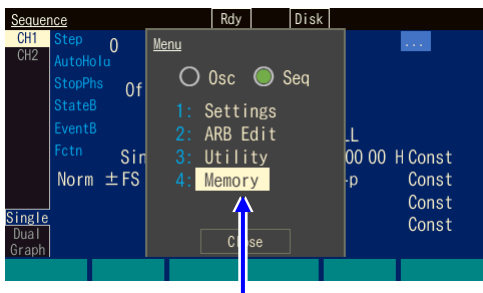

In the top menu, select [Memory]

1. When the MENU key is pressed, the top menu opens. Then, select [Memory]. This opens the Memory screen.

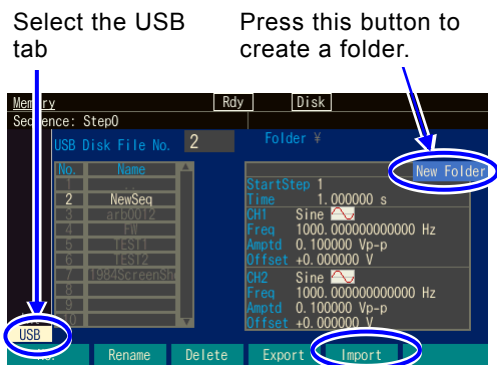

Press [Import] soft key.

2. Select the USB tab at the bottom left of the screen and then press the ENTER key to set the save destination to USB flash memory. Folders have "¥" at the end of the name. When a folder is selected, pressing the [Enter] soft key moves to the specified folder (selecting "..¥" moves one folder up). To create a new folder, select the [NewFolder] button and then press the ENTER key. The dialog box for entering a folder name is displayed. Enter the name and then press the [OK] soft key.

A sequence can be renamed.

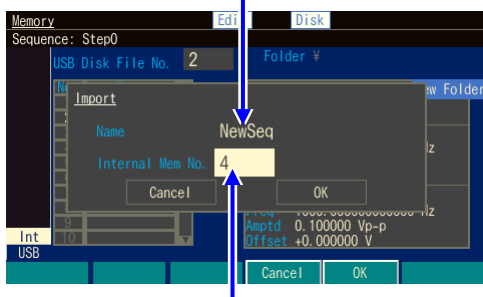

Specify the internal memory number of the save destination.

3. Press the [Import] soft key to display the dialog box for recalling. Specify a sequence name in the [Name] field and specify the sequence number of the copy destination in the [Internal Mem Num] field. Press the [ENTER] key to recall from USB flash memory.

## 11.8 File Operations

Perform the operations of deleting and renaming the sequence data in internal memory and also deleting and renaming the sequence data and creating, deleting, and renaming folders in USB flash memory on the Memory screen.

### 11.8.1 To Delete Saved Sequence Data

Specify the sequence number to be deleted.

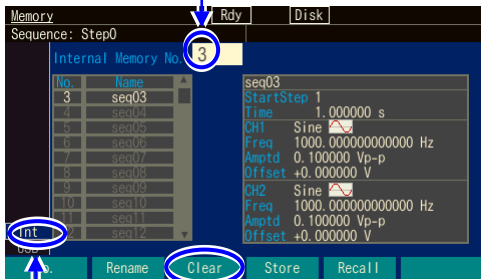

Delete sequence

This indicates that internal memory will be deleted.

1. Specify the target with a number in the file number selection field at the top left of the screen.

Specify the number of the file you want to delete.

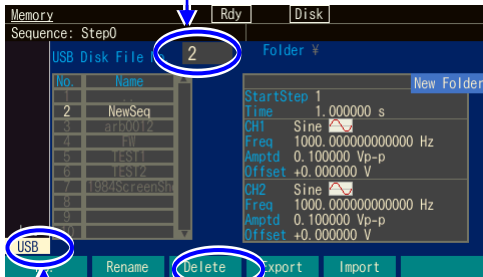

Select the USB tab

Finally press the Delete soft key.

When the target is a file or folder in USB flash memory, a screen such as the one on the left will be displayed.

Folders have "¥" at the end of the name. When a folder is selected, pressing the [Enter] soft key makes that folder the current folder. ".. ¥" indicates the folder one level up.

The dialog box for deleting a file or folder is displayed.

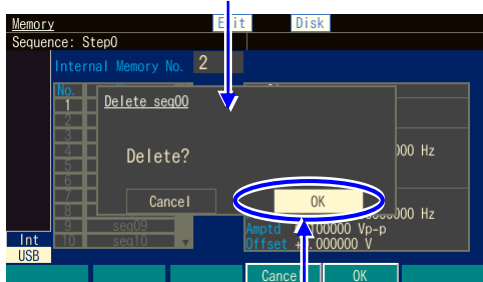

Press the [OK] soft key to delete.

2. Press the [OK] soft key to delete.

### 11.8.2 To Rename

To rename arbitrary waveform data in internal memory or rename arbitrary waveform data or a folder in USB flash memory, use the [Rename] soft key.

Specify the number of the target you want to rename.

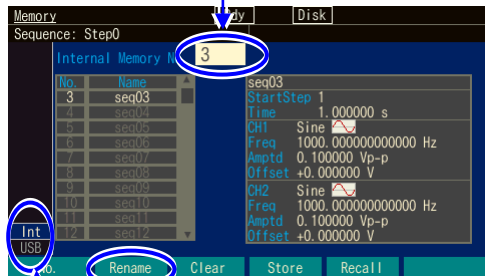

Select the Int tab  
Finally press the [Rename] soft key.

1. Specify the target with a number in the file number selection field at the top left of the screen
2. Press the [Rename] soft key to display a dialog box for renaming.

Select the files and folders by changing here.

The name of the selected file or folder is displayed.

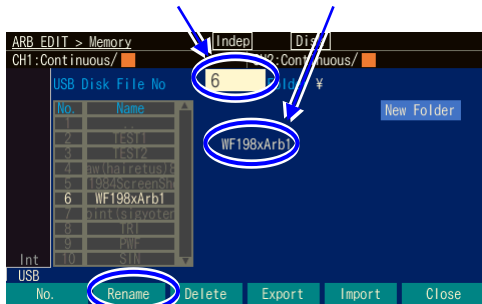

Finally, press the [Rename] soft key.

When the target is a file or folder in USB flash memory, a screen such as the one on the left will be displayed.

Folders have "¥" at the end of the name.

When a folder is selected, pressing the [Enter] soft key makes that folder the current folder.

".. ¥" indicates the folder one level up.

3. Select the [Name] field, press the ENTER key, and change the name. Move the cursor with the left and right arrow keys. Change a character with the up and down arrow keys or the modify knob.

Once the name has been changed, press the [OK] soft key to confirm it. Press the [Cancel] soft key to discard the change.

### 11.8.3 To Create a Folder in USB Flash Memory

Folders have "¥" at the end of the name. When a folder is selected, pressing the [Enter] soft key makes that folder the current folder. ".. ¥" indicates the folder one level up.

Select the [New Folder] button and then press the ENTER key.

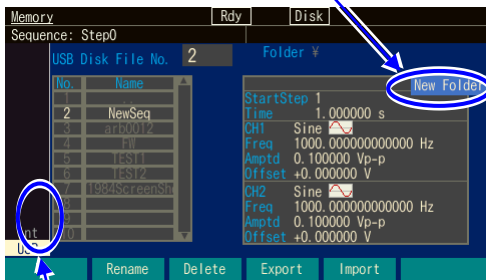

1. Select the [New Folder] button at the top right of the screen and press the ENTER key to open the dialog box for entering a folder name.

This indicates whether will be saved to the unit's internal memory or USB flash memory. To save to USB flash memory, select [USB] and press the ENTER key.

The dialog box for creating a folder is displayed.

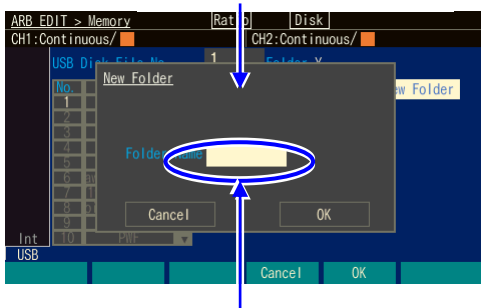

2. Select the [New Folder] button at the top right of the screen and then press the ENTER key. Specify the target with a number in the file number selection field.

Select the [Folder Name] field, enter a name, and press the [OK] soft key to change the name.

## 11.9 Outline of Screen

- Text display [Single]

The step control parameters of one step and the intra-step channel parameters of one channel are displayed simultaneously.

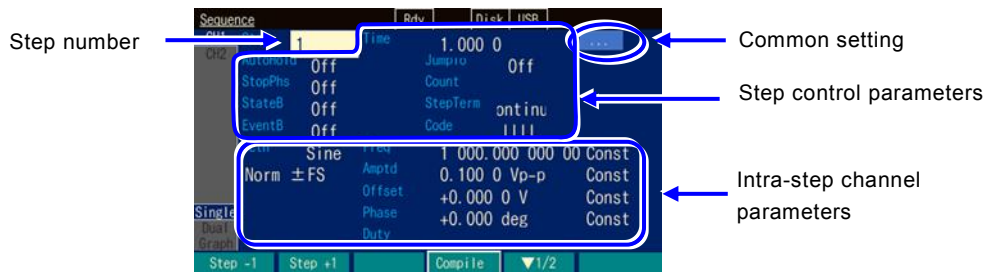

- 2-channel simultaneous display [Dual] (WF1984 only)

The intra-step channel parameters of one step are displayed for two channels simultaneously. For the step control parameters, only the step time is displayed.

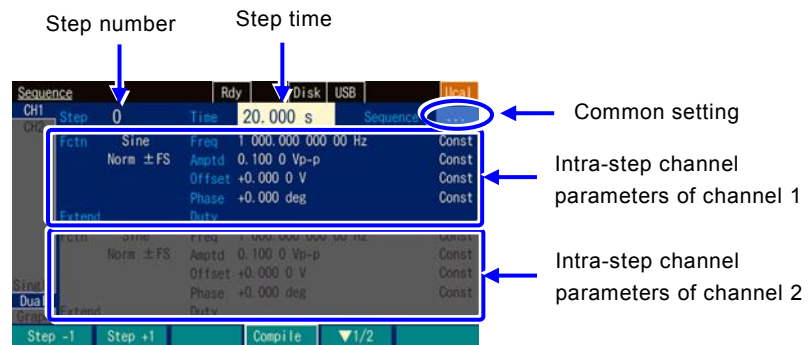

■ Graph display [Graph]

Graph display shows the trends along the step progress for four intra-step channel parameters. However, the trend shown is only for the case where the step progresses according to the step number from Step 0. The status of the case where the sequence does not progress according to the step number due to a jump or branch is not displayed.

Which parameter is to be displayed in which trace can be set in the trace setting.

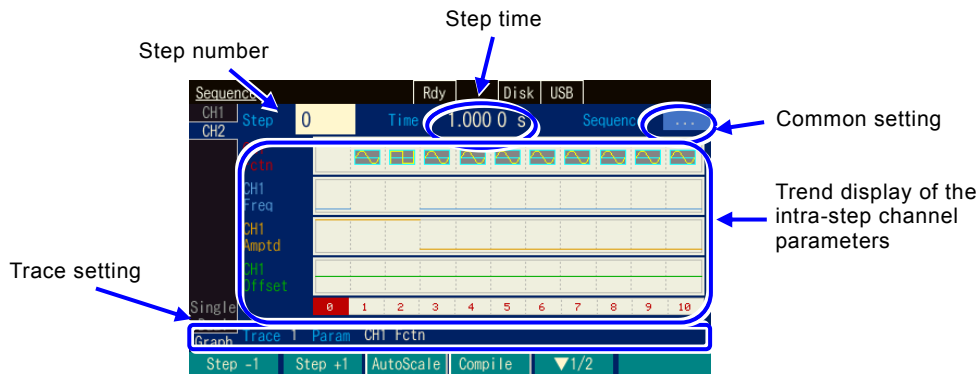

[PRM] and [SCL] displayed in the trace settings indicate the display item and the height of the trace frame, respectively. [OFS] indicates the bottom value of the trace frame for frequency, amplitude, and duty, and the center value of the trace frame for offset and phase.

With the [TRC Setup] soft key in the second row, the settings of four traces and the graph colors can be changed collectively.

The [AutoScale] soft key in the second row adjusts the vertical-axis scale of the graph displayed, including the unused steps, so that the scale does not become saturated.

## 11.10 Individual Descriptions of Step Control Parameters

### Step time [Time]

This parameter sets the step duration.

### Auto hold [AutoHold]

Normally, set this to off.

Set this parameter to on when you wish the sequence to go into standby without moving on to the next step after the lapse of the specified step time. This is useful when you want to move through the sequence while checking the status of the equipment under test step by step.

When the resume operation or resume signal is received, the processing resumes.

In step #0, [AutoHold] cannot be selected.

### Stop phase [StopPhs]

When this parameter is set to on, the reference phase at the end of that step can be specified.

After the lapse of the specified step time, that step ends when the specified reference phase has been reached.

### Jump destination [JumpTo]

When this parameter is set to on, the next step which the sequence moves to after the end of the current step can be specified.

By specifying the jump count [Count], you can configure a loop which repeats the same step.

In step #0, [JumpTo] cannot be selected.

### Jump count [Count]

When this is set to on, you can specify the number of jumps to the step specified with [JumpTo] (jump destination). When this is set to [Inf], the jump is repeated for an infinite number of times.

Note that the number of times that the same step is repeated is [jump count + 1].

In step #0, [Count] cannot be selected.

### State branch [StateB]

When this is set to on, the state branch signal of multi-I/O connector (pin 14) is checked and if the signal is active, the sequence moves to the specified step. However, the state branch signal can be checked only after the lapse of the specified step time of that step (excluding the time that held).

☞P.11-8, P.11-12

In step #0, [StateB] cannot be selected.

### Event branch [EventB]

When this is set to on, the soft keys or event branch signal of multi-I/O connector (pin 11) is checked and if the signal is active, the sequence moves to the specified step.

☞P.11-8, P.11-12

In step #0, [EventB] cannot be selected.

### Step termination [StepTerm]

This parameter specifies whether to jump to the next number step ([Continue]) or to go to Step 0 and end the sequence ([End]) upon termination of the step.

In step #0, [StepTerm] cannot be selected.

### Step synchronization code output [StepCode]

This parameter sets the 4-bit logic signal that is output to the multi-I/O connector during that step. The left-most bit is D3 (MSB), and the right-most bit is D0 (LSB).

For multi-I/O connector, ☞P.3-13.

D0 (LSB) can be output to the synchronization/sub-output terminal. ☞ P.11-10

MEMO



## 12. Using User-defined Units

12.1	About User-defined Units .....	12-2
12.2	Display and Setting in User-defined Units.....	12-2
12.3	Defining User-defined Units.....	12-2

## 12.1 About User-defined Units

You can set, for example, the frequency in units of rpm (number of rotations per minute) instead of Hz. You can also set a value converted to the mechanical deviation quantity or a value converted to the output voltage after the power amplifier output instead of voltage.

Defining these mutual conversion formulas enables you to use them like the usual units. In this product, these units are called "user-defined units."

The user-defined units can be used for the following six parameters:

Frequency, period, amplitude, DC offset, phase, and duty

## 12.2 Display and Setting in User-defined Units

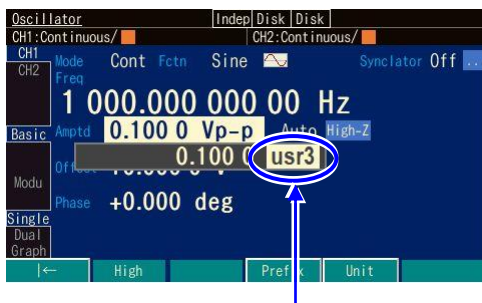

When an input field for each parameter opens, you can change the unit by placing the cursor over the unit at the right end and using the up/down arrow key or the modify knob. The unit name displayed here can be set arbitrarily. Even if you change the unit, just the display unit is changed without changing the actual output value.

Select the user-defined unit

## 12.3 Defining User-defined Units

### ■ Setting screen

The setting is done on the Utility screen.

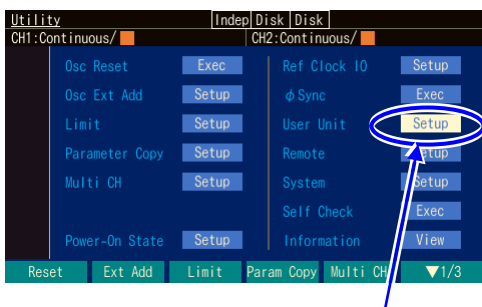

1. In the Utility screen, select the [User Unit] field and press the ENTER key.

In the Utility screen, select the [User Unit] field and press the ENTER key.

## 12.3 Defining User-defined Units

- The user-defined unit setting window opens. Select the respective item and then press the ENTER key and configure the setting. Alternatively, you can open the input field by pressing the corresponding soft key.

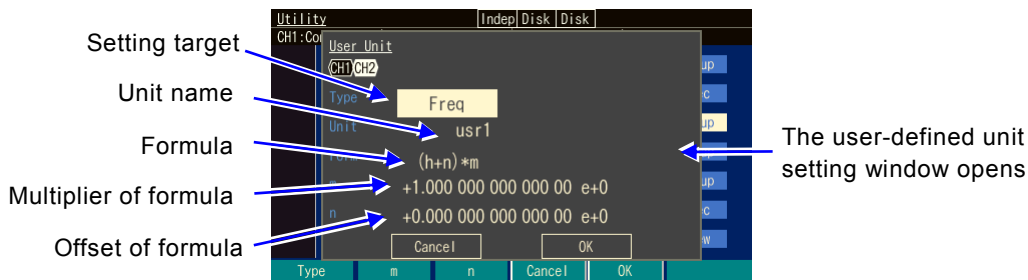

The following items can be set in this window:

Setting target [Type]

Select from frequency, period, amplitude, DC offset, phase, and duty.

Unit name [Unit]

Sets the unit name with up to 4 characters. Enter a character one by one at the cursor position using the up/down arrow key, the modify knob, or the numeric keypad.

Formula [Form]

Select either  $[(h+n)*m]$  or  $[(\log(h)+n)*m]$  as the unit conversion formula. Here,  $h$  is an original value of the setting target. The value converted by this formula is displayed on the screen when the user-defined unit is actually used.

The unit of  $h$  is defined as shown in the following table depending on the setting target:

Setting target	Unit of h
Frequency	Hz
Period	s
Amplitude	If amplitude range is $\pm FS$ , then $V_{p-p}$ If amplitude range is $0/+FS$ and $-FS/0$ , then $V_{pk}$ A value under the designated load impedance condition in each case
DC Offset	V A value under the designated load impedance condition
Phase	deg
Duty	%

## 12.3 Defining User-defined Units

The log is a common logarithm whose base is 10. You need to be careful when using a log formula for a value that can be negative such as the DC offset and phase. If the value before changing to the user-defined unit is zero (0), "-Inf" is displayed when changing to the user-defined unit using the log. Similarly, if the value before changing to the user-defined unit is negative, "Over" is displayed when changing to the user-defined unit using the log.

Multiplier and offset of formula: [m] and [n]

Select the multiplier m and offset n in the selected formula.

After setting each parameter, select [OK] at the bottom of the window and press the ENTER key.

### Check

When you use a user-defined unit, the setting resolution may be rough depending on the setting of the multiplier or offset.

#### ■ To set the frequency in rpm

To display and set, for example, the frequency 1 Hz as 60 rpm, set the following and then press the [OK] key.



Type: Freq  
Unit: rpm  
Form: (h+n)\*m  
m: 60  
n: 0

Next, in the Oscillator screen, open the input field for the frequency, and then change the unit from Hz to rpm.

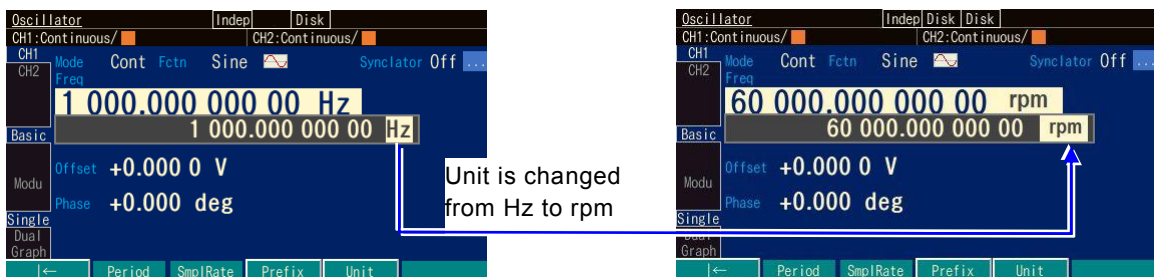

Setting and displaying the frequency as an rpm value is now possible.

## 13. Other Utility Settings

13.1	Selecting Remote Interface [Remote] .....	13-2
13.2	Display and Operation Sound Settings [System] .....	13-3
13.3	Self-Diagnosis [Self Check] .....	13-3
13.4	Product Information Display [Information] .....	13-4

## 13.1 Selecting Remote Interface [Remote]

Select the external control interface from USB, GPIB and LAN.

### ■ GPIB setting screen

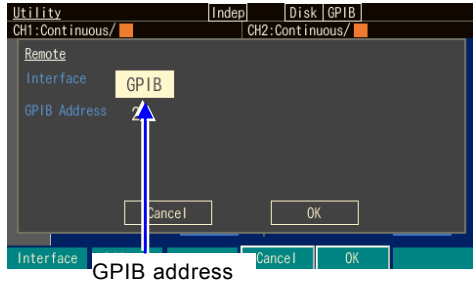

If GPIB was selected, set a GPIB address in the range of 0 to 30.

### ■ USBTMC setting screen

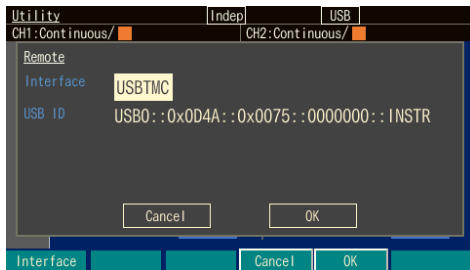

When you select USBTMC, the USB ID is displayed. There is no specific setting with USB.

### ■ LAN setting screen

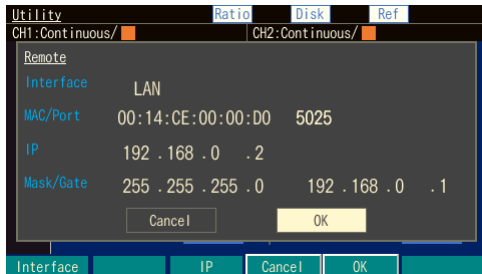

When you select LAN, the MAC address and port address are displayed. Set IP address and subnet mask. The default gateway can also be set if necessary.

## 13.2 Display and Operation Sound Settings [System]

### ■ Operation Sound Setting

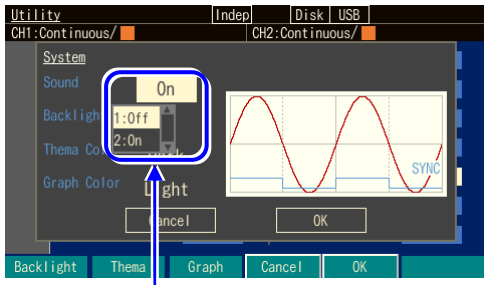

Select the [SOUND] field and then press the ENTER key.

The operation sound can be set in the System screen.

Select the [OK] field and press the ENTER key to open the operation sound selection list.

### ■ Display Setting

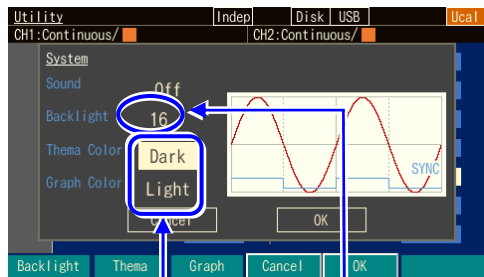

Theme color

Brightness of backlight

Set the brightness of backlight.

You can switch the theme color between displaying bright color characters on a dark background and dark color characters are displayed on a bright background as a color tone.

## 13.3 Self-Diagnosis [Self Check]

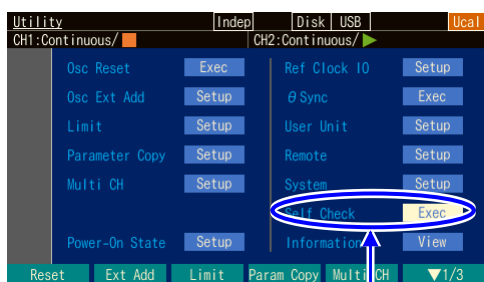

Self-Diagnosis

Self-diagnosis checks the internal status. Perform this after setting initialization.

When the check is finished, the results are displayed. Select [OK] and then press the ENTER key to shut down the unit.

Before executing this, disconnect all cables except the power cable from the product to reduce the effect of noise.

In rare cases, an error may occur due to the effect of noise. If you encounter an error repeatedly, please contact NF Corporation or one of our representatives.

### 13.4 Product Information Display [Information]

The model name, firmware version, and other information about this product are displayed. There are no items to be set.

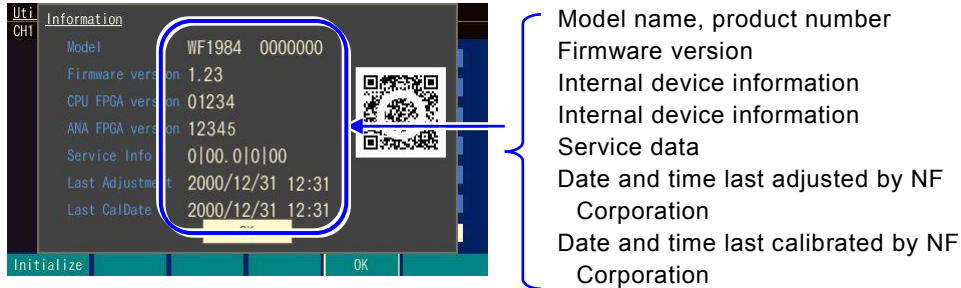

■ Service data details

The service data has five areas separated by "|" that contain the following information, respectively.

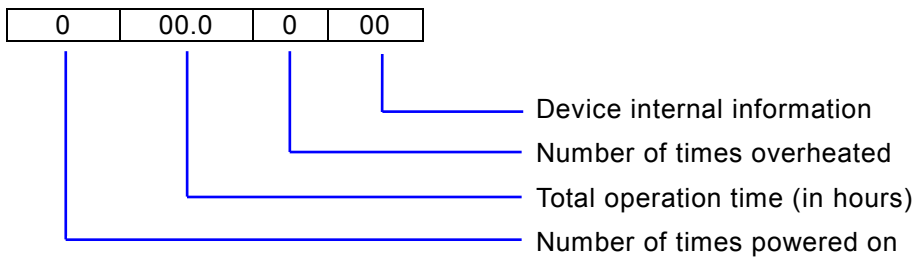

■ Details of 2D barcode

The information in the 2D barcode consists of our company name, model name, manufacturing number, device information, firmware version, and date last calibrated by NF Corporation



# 14. Troubleshooting

14.1	Error Messages at Power-on.....	14-2
14.2	Error Messages while Running.....	14-3
14.3	Conflict Messages for Modulation .....	14-8
14.4	Conflict Messages for Sweep .....	14-9
14.5	Conflict Message for Burst .....	14-10
14.6	Sequence Compiler Message .....	14-11
14.7	When Suspect a Failure .....	14-12

### 14.1 Error Messages at Power-on

At power-on, self-diagnosis is performed and an error message is displayed if there is any problem. If you encounter any failure, please contact NF Corporation or one of our representatives. If a message is displayed to notify you that the instrument shut down due to overheating, check if there is anything wrong with the installation environment (whether the product is in an environment with an ambient temperature that will cause overheating).

#### Hardware initialization failed

This is an internal error. This is a failure of this instrument.

#### OSC-Block error

This is an internal error. This is a failure of this instrument.

#### RAM error

This is an internal memory error. This is a failure of this instrument.

#### ROM error

This is an internal memory error. This is a failure of this instrument.

#### Last shutdown caused by overheat

The last power-off was caused by internal overheating.

Check the operating environment and status of this instrument.

#### Output not turned on due to overload

The setting for output at power-on is on, but output did not turn on because an overloading of waveform output or synchronization/sub-output was detected.

Check the connection of the output terminal because it may be connected to an external voltage source. Remove the overload state before turning output on.

#### Output overload detected; Output turned off

Output turned on once according to the setting for output at power-on, but it was turned off because overloading of the waveform output or synchronization/sub-output was detected.

Check the connection of the output terminal because it may be connected to an external voltage source. Remove the overload state before turning output on.

## 14.2 Error Messages while Running

Error messages are displayed while the product is running mainly when a setting exceeds the allowable output range. For example, when a square wave is output and you try to set the frequency to 100MHz, an error is displayed and the frequency is set to the maximum frequency for a square wave.

Error messages are also displayed for internal overheating and output overload.

This section describes the errors displayed in the dialog box in ascending order of the error numbers.

### 12005: Internal overheat detected

The inside of the instrument is overheated.

The ambient temperature may be too high or the instrument may be faulty. It is recommended to turn the instrument off.

### 14006: Internal temperature too high; Auto-shutdown will occur

The instrument is automatically turned off because internal overheating reached the limit.

The ambient temperature may be too high or the instrument may be faulty.

### 22017: Function changed to Sine by changing Channel Mode

The waveform of the corresponding channel was switched to a sine wave because a 2-channel coordination mode was selected when the waveform is noise or DC.

### 22018: Mode changed to Continuous by changing Channel Mode

The mode was switched to continuous oscillation mode because a 2-channel coordination mode was selected in the burst mode.

The burst mode cannot be used in a 2-channel coordination mode.

### 22019: Modulation Source changed to Internal due to Channel Mode

The modulation source was changed to internal due to circumstances of the 2-channel coordination mode.

When a 2-channel coordination mode is selected, the modulation source is first set to internal regardless of the modulation type.

When the channel mode is 2-phase, constant frequency difference, or constant frequency ratio, the modulation source of FM and FSK is limited to internal. There is no limitation on the modulation source of other types, so try configuring the settings again. When the channel mode is differential, the modulation source is limited to internal regardless of the modulation type.

### 22020: External addition turned off by changing Channel Mode

External addition turned off because differential was selected for the channel mode when using external addition.

External addition cannot be used in the differential mode.

### 22021: SwpMode changed to Single by changing Channel Mode

The sweep oscillation mode was changed to single sweep because 2-phase, constant frequency

difference, constant frequency ratio, or differential was selected for the channel mode when the sweep oscillation mode was gated.

In a 2-channel coordination mode, gated single sweep cannot be used.

### 22022: Synclator turned off by changing Channel Mode

Synclator was turned off because the channel mode was changed.

### 22024: Mode changed to Continuous by changing Function

The mode was switched to continuous oscillation mode because a waveform that is not compatible with the current oscillation conditions was selected in the modulation, sweep, or burst mode.

For example, when the waveform is changed from pulse wave to sine wave during PWM, the mode is switched to continuous oscillation because PWM is not available for sine wave.

### 22026: Start-locked occurred due to setting conflict

The prescribed oscillation cannot be started because an operation setting is inappropriate in the modulation, sweep, or burst mode.

If you press the soft key [?] on the far left, a message about the inappropriate item will appear.

### 22027: SubOut selection changed to Sync by changing modulation source

Reference phase synchronization [Sync] was assigned for synchronization/sub-output because the modulation source was changed from internal to external.

Modulation synchronization [ModSync] and modulation waveform [ModFctn] can be selected for synchronization/sub-output when the modulation source is internal.

### 22030: Edge time changed due to Width

The edge times (LE and TE) were shortened because the specified pulse width time cannot be achieved with the current edge times.

The pulse width time takes precedence over the edge times.

### 22031: Edge time changed due to Duty

The edge times (LE and TE) were shortened because the specified pulse width duty cannot be achieved with the current edge times.

The pulse width duty takes precedence over the edge times.

### 22032: Edge time and/or Width changed due to Frequency

The edge times (LE and TE) and pulse width time were changed because the specified frequency cannot be achieved with the current edge times and pulse width time.

The Frequency takes precedence over the edge times and pulse width time.

### 22033: Edge time and/or Duty changed due to Frequency

The edge times (LE and TE) and pulse width duty were changed because the specified frequency

cannot be achieved with the current edge times and pulse width duty.

The frequency takes precedence over the edge times and pulse width duty.

### 22035: Selected ARB is missing; Edit Memory ARB assigned

The specified arbitrary wave does not exist so an arbitrary wave in the edit memory was assigned instead of it.

This error occurs when an arbitrary wave used in the past is deleted while not being used. An arbitrary wave is identified only with the number.

### 22036: Too narrow or too wide Duty specified; Amplitude may decrease or pulse may be lost

The amplitude may have decreased or the pulse may have been lost because the duty was set very low or high.

This event occurs when the pulse width of a square wave with an extended duty variable range is narrower than 8.4 ns on the low or high side.

### 22037, 22038: Frequency reduced due to Function

The frequency was changed to a lower value to match the waveform.

The upper limit of frequency depends on the waveform.

### 22039: Duty changed due to Extend-Off

The duty was changed to a value limited by frequency because the duty variable range of the square wave was changed to standard.

When the duty variable range is standard, it changes based on the frequency.

### 22040: Duty changed due to Frequency

The duty was changed to a value limited by frequency because the duty variable range of the square wave is standard.

When the duty variable range is standard, it changes based on the frequency.

### 22041: High level changed due to Low level

The change to the low level also changes the high level based on the possible output range.

### 22042: Low level changed due to High level

The change to the high level also changes the low level based on the possible output range.

### 22043: Not acceptable due to another CH limitation

The specified setting cannot be set due to another channel restriction in the 2-channel equivalence settings.

### 22044: Frequency and/or DeltaFreq changed due to Function

The frequency and the frequency difference were changed to match the upper limit frequency of the waveform when the channel mode was constant frequency difference.

### 22045: Frequency of CH1 changed due to DeltaFreq

The frequency of CH1 was changed to maintain the frequency difference when the channel mode was constant frequency difference.

The frequency difference takes precedence over the frequency of CH1.

### 22047: Frequency changed due to Function

The frequency was changed to match the upper limit frequency of the waveform when the channel mode was constant frequency ratio.

### 22048: Frequency of CH1 changed due to Ratio

The frequency of CH1 was changed to maintain the frequency ratio when the channel mode was constant frequency ratio.

The frequency ratio takes precedence over the frequency of CH1.

### 22050: Synclator turned off due to ModuType:FSK/PSK/FM

The synclator was turned off because the modulation type was changed to FSK/PSK/FM.

### 22166, 22168: ModuSrc of CH2 changed to Int/Ext due to CH1 or CH2 setting

The modulation source of CH2 was changed to internal or external due to a setting change of CH1 or CH2 because the modulation source of CH2 was set to CH1 external for FSK or PSK.

The CH2 modulation source can be set to CH1 external only if CH1 and CH2 are the same modulation type and external is selected as the modulation source of CH1.

### 22167: TrigSrc of CH2 changed to Int due to CH1 or CH2 setting

The trigger source of CH2 was changed to internal due to a setting change of CH1 or CH2 because the trigger source of CH2 was set to CH1 external for sweep or burst.

The trigger source of CH2 can be set to CH1 external only when external is selected as the trigger source of CH1 under the following conditions.

- CH1 and CH2 have the same sweep type. CH1 and CH2 are in the same sweep mode (except for continuous sweep).
- CH1 and CH2 are in the same burst mode (except for auto burst).

### 23067: Data out of range; Data discarded

The input value was discarded because you attempted to enter a value outside of setting range.

### 23145: MOD/ADD IN connector used by external addition now

The MOD/ADD IN connector is currently used for external addition. It cannot be used for external modulation at the same time.

### 23146: MOD/ADD IN connector used by external modulation now

The MOD/ADD IN connector is currently used for external modulation. It cannot be used for

external addition at the same time.

### 23172 to 23175: Output overload detected; Output turned off

The output was turned off because an overload was detected in waveform output or synchronization/sub-output.

Check the connection because the output terminal may be connected to an external voltage source.

Remove the overload state before turning output on.

### 32004: Not able to delete this ARB; This ARB is in current use

An arbitrary wave that is currently being output or used cannot be deleted.

In the modulation mode, an arbitrary waveform that is used as an internal modulation wave cannot be deleted.

### 35005: File-system error

This is an internal error. This is a failure of this instrument.

### 60002: ARB waveform under editing not stored; Shutdown?

The arbitration waveform being edited has not been stored yet.

It will be cleared when the power turns off. Store it as needed.

### 60015: Self Check failed; Auto-shutdown will occur

The self check failed. Turn the power on/off.

The instrument may have a failure.

### 61056: Data beyond lower limit; Value clipped to lower limit

The value was set to the lower limit because you attempted to set a value below the lower limit.

### 61057: Data beyond upper limit; Value clipped to upper limit

The value was set to the upper limit because you attempted to set a value above the upper limit.

### 61058: Zero data not allowed

Zero cannot be set for this parameter.

### 61059: Invalid operation

This operation is invalid. You are attempting to insert a control point where it cannot be inserted while editing arbitration wave.

### 61060: Invalid operation

This operation is invalid. You are attempting to delete a control point that cannot be deleted while editing an arbitrary wave.

### 14.3 Conflict Messages for Modulation

These messages are displayed when the [?] soft key is pressed when the specified modulation cannot be executed due to an inappropriate setting (conflict state). They explain about the inappropriate setting.

#### HopFreq beyond upper limit for current Function

The hop frequency is beyond the allowable range of the current waveform to output in FSK.  
Decrease the hop frequency.

#### MOD/ADD IN connector used by external addition now

The MOD/ADD IN connector cannot be used for external modulation because it is currently being used for external addition.  
Turn the external addition function off.

#### Modulated peak or bottom value out of range

[Carrier value + deviation] or [carrier value - deviation] is beyond the allowable range to output in FM, PM, OFSM, PWM.  
Change the carrier value or decrease the deviation.

#### Modulated peak or bottom phase out of range

[Carrier value + deviation] is beyond the allowable range to output in PSK.  
Change the carrier value or decrease the deviation.

#### Modulation Type not compatible with current Function

The modulation type is not compatible with the current waveform. For example, PWM is specified for a sine wave.  
Change the modulation type.



### 14.4 Conflict Messages for Sweep

These messages are displayed when the [?] soft key is pressed when the specified sweep cannot be executed due to an inappropriate setting (conflict state). They explain about the inappropriate setting.

#### Frequency beyond upper limit for Gated sweep

The frequency is beyond the upper frequency of gated sweep.

Lower the frequency.

#### Gated sweep not available for DC

Gated sweep is not available for DC waveform.

Change the sweep mode to continuous or single.

#### Start value out of range

The start value is beyond the allowable range to output.

Change the value so that it falls within the range.

#### Stop value out of range

The stop value is beyond the allowable range to output.

Change the value so that it falls within the range.

#### Sweep Type not compatible with current Function

The sweep type is not compatible with the current waveform. For example, duty sweep is specified for a sine wave.

Change the sweep type.

## 14.5 Conflict Message for Burst

These messages are displayed when the [?] soft key is pressed when the specified burst cannot be executed due to an inappropriate setting (conflict state). They explain about the inappropriate setting.

### BrstMode not compatible with current Function

The burst oscillation mode is not compatible with the current waveform. For example, trigger burst is specified for noise.

Change the burst oscillation mode.

### Frequency beyond upper limit for current Function

The frequency is beyond the upper frequency of the current waveform.

Decrease the frequency.

## 14.6 Sequence Compiler Message

These messages are displayed when a setting with which execution is not possible was found as a result of sequence compilation.

Amptd-Offset conflict CH:N Step:M

Amptd(Step K) - Offset(Step L)

The amplitude and offset do not satisfy mutual restriction in step M of channel N. The amplitude is set in step K and the offset is set in step L.

Decrease the amplitude or offset.

Fctn-Freq conflict

CH:N Step:L-M

The frequency exceeds the upper limit for the waveform between step L and step M of channel N.

Decrease the frequency.

Fctn-Freq-Duty conflict

CH:N Step:M

Freq(Step K) - Duty(Step L)

The frequency and duty of the square wave do not satisfy mutual restriction in step M of channel N. The frequency is set in step K and the duty is set in step L.

Decrease the frequency or bring the duty close to 50%.

Selected ARB is missing

CH:N Step:M

The arbitrary wave specified in step M of channel N does not exist.

Specify another arbitrary wave.

Selected ARB loading failed

CH:N Step:M

The arbitrary wave could not be read in step M of channel N.

This is an internal error. This is a failure of this instrument.

Too complex to check

The sequence was too complex to be checked.

Simplify the sequence structure.

Too many or too large Functions used

The number of waveforms used exceeds 4 096 or the total exceeds 64 MiW.

Reduce the number of waveforms. Or reduce the number of data points of the arbitrary wave in array format.  P.11-9

## 14.7 When Suspect a Failure

When an abnormality is suspected, perform the corresponding action below. If this fails to resolve the problem, please contact NF Corporation or one of its representatives.

Problem	Possible cause	Action	Reference page
The power does not turn on	A power supply out of the rated range is being used.	Use a power supply within the rated range.	"2.3 Grounding and power supply connection" P. 2-4
	A malfunction is occurring due to external noise, etc.	Install the instrument in a location with suitable conditions.	"2.2 Installation" P.2-2
Panel operation is not possible	In the remote state	Change to the local state.	—
	Keys and/or modify knob are deteriorated.	Contact NF Corporation and request repair.	—
Setting is not possible.	The setting range limit values are set to low values.	Change the setting range limit values or perform initialization.	"4.4.18 To Set the Setting Range Limit Values" P.4-57
Output level is abnormal	The ambient temperature/humidity range is out of the guaranteed operating range.	Use in the environment within the specified range.	"2.2 Installation" P.2-2
Output level is abnormal	Warm up is insufficient.	Allow to warm up for more than 30 minutes after the power turns on.	—
Setting by remote control is not possible	DC offset has been added.	Set the DC offset to 0 V.	"4.4.9 To Set DC Offset" P. 4-38
	A user-defined unit is being used.	Select the standard unit.	"4.4.8 To Set Amplitude" P.4-37
	The load impedance function is being used.	Change the setting to Hi-Z.	"4.4.13 To Set Load Impedance" P.4-44
	A different interface is set.	Match the setting to the interface being used.	"13.1 Selecting Remote Interface" P. 13-2
Setting by remote control is not possible	The GPIB address, USB ID, or LAN parameter is different from that in the program.	Match the GPIB address, USB ID, or LAN parameter to that in the program.	"13.1 Selecting Remote Interface" P. 13-2
Self-diagnosis identified an error	The GPIB address is the same as that of another device.	Set the GPIB address again so that it is not the same as that of another device.	"13.5 Self-Diagnosis" P.13-3
	A malfunction occurred due to external noise.	Remove all cables other than the power cable from the device and perform the self-diagnosis again.	
Does not become same as described in Instruction manual	Initialization has not been performed.	The explanations presume that initialization has been performed. Perform initialization.	"4.3.8 To Restore Initial Settings" P.4-26
Does not become same as described in Instruction manual	The channel to be operated is the opposite channel.	Check whether the channel is CH1 or CH2.	"4.3.6 CH1 / CH2 Switching Key and Active Channel (WF1984 Only)" P.4-22

## 15. Maintenance

15.1	Introduction .....	15-2
15.2	Routine Maintenance.....	15-2
15.3	Storage When Not Used for a Long Period of Time .....	15-3
15.4	Repacking and transportation.....	15-3
15.5	Operation Inspections.....	15-5
15.6	Performance Tests.....	15-6

## 15.1 Introduction

This chapter describes the following.

- Routine maintenance
- Precautions and storage method when not used for a long period of time.
- Precautions for repacking and transportation when transported.
- Performance tests necessary when, for example, performing preventive maintenance and verifying performance during operation inspection and after repair.

This instruction manual describes the operation inspection and the performance testing methods that can be easily performed.

For more accurate inspections, adjustments, calibrations, or repairs, contact NF Corporation or one of our representatives.

---

### **WARNING**

This product contains high-voltage components. Do not remove its cover. Inspection of the inside of the instrument must not be performed by anyone except trained service technicians with extensive experience in hazard prevention.

---

## 15.2 Routine Maintenance

Install and use this unit in a location that satisfies the installation conditions. Details on installation conditions  P.2-3

The front panel of this unit is made of plastic. Take care not to damage it with a sharp or hot object. When the panel/housing surface needs cleaning, wipe it with a soft cloth. To remove persistent contamination, wipe it with a soft cloth soaked with neutral detergent and wrung out. Never use any organic solvents like thinner or benzene or chemical cleaning cloths as they may cause the surface finish to deteriorate or peel off.

When the surface of the LCD becomes dirty, wipe it with absorbent cotton or a soft cloth. Avoid using detergents, organic solvents, etc., as they may cause deterioration or tarnishing.

### 15.3 Storage When Not Used for a Long Period of Time

- Disconnect the power cord from the outlet and the unit.
- Store the unit in a location free from falling objects and dust, such as a shelf or rack.  
If dust may be present, cover the unit with a cloth or polyethylene cover.
- The environmental conditions for storage are  $-10^{\circ}\text{C}$  to  $+50^{\circ}\text{C}$  and 5% to 95% RH. However, avoid a location where the temperature fluctuates significantly or where the unit will be exposed to direct sunlight, and store the unit in an environment as close to room temperature as possible.

### 15.4 Repacking and transportation

When repacking the unit to transport or send it for repairs, pay attention to the following points.

- Store away the tilt legs located on the unit lower base.
- Wrap the unit in a polyethylene bag or sheet.
- Prepare a carton box that can sufficiently withstand the weight of the unit and is of a large enough size to accommodate it.
- Fill the carton box with cushioning material so that the top, bottom, and four sides of the main unit can be protected.
- When making a request for transportation, inform the transport operator that the product is a precision instrument.

For how to check the product firmware version, see the section 13.6.  P. 13-4

■ Equipment

The following measuring instruments are required to perform the operation inspections and performance tests.

	Requirement	Sample Model	Intended Purpose
Digital multi-meter	AC voltage (TrueRMS) Accuracy: $\pm 0.1\%$ (1 kHz to 100 kHz) DC voltage Accuracy: $\pm 0.1\%$	Keysight 3458A	Measurement of AC voltage of 100 kHz or lower, and DC voltage.
Power meter and power sensor	100 kHz to 30 MHz 5 $\mu$ W to 250 mW (-23 dBm to +24 dBm) Accuracy: 0.02 dB Resolution: 0.01 dB	NRP6A and NRP-ZKU/03	Measurement of AC voltage of 100 kHz or greater
Universal counter	Accuracy: 0.1 ppm	Keysight 53220A Opt 010 (highly-stabilized TB)	Measurement of frequency, duty, time difference between channels
Oscilloscope	300 MHz or greater 2 GS/s, 50 $\Omega$ input	Tektronix MDO3032	Measurement of leading edge and trailing edge times
Audio analyzer	0.01 % or lower, THD measurement	Panasonic VP-7722A	Harmonic distortion measurement
Spectrum analyzer	10 kHz to 1 GHz Resolution: 100 Hz	Keysight N9322C	Measurement of non-harmonic spurious
BNC cable	Characteristics impedance: 50 $\Omega$ Length: 1 m, 30 cm		—
BNC(f)-banana adapter	—	—	
BNC(f)-N(m) adapter	Characteristics impedance: 50 $\Omega$		To connect a BNC cable to a spectrum analyzer
BNC(f)-N(f) banana adapter	Characteristics impedance: 50 $\Omega$	—	To connect a BNC cable to a power sensor



## 15.5 Operation Inspections

### ■ Checks before operation inspections

Check the following before the operation inspections.

- The power supply voltage is within the rated range.
- The ambient temperature is within the range of 0 to +40°C.
- The ambient relative humidity is within the range of 5 to 85%RH (furthermore, the absolute humidity is within the range of 1 to 25 g/m<sup>3</sup>).
- Non-condensing.

### ■ Function check

#### • Checks at power-on

Check that no error message appears at power-on.

If an error message appears,  P. 14-2.

If an error message is displayed at the power-on, turn the power off, wait for at least 5 seconds, and turn the power-on again.

#### • Self-diagnosis

Run [Self Check] on the Utility screen.

 P.13-3

#### • Checks of important functions

To avoid miss-setting, perform initialization first (run [Reset] in the Utility screen).

Then, connect the FCTN OUT to the oscilloscope using characteristic impedance 50Ω series coaxial cable and observe the output.

Change the following settings several times and check that the instrument works properly.

For items that set numeric values like the frequency, more reliable checks can be performed by operating both the numeric keypad and modify knobs.

- Waveform (shortcut key: FCTN key FCTN)
- Frequency (shortcut key: FREQ key FREQ)
- Amplitude (shortcut key: AMPTD key AMPTD)
- DC offset (shortcut key: OFFSET key OFFSET)
- Output on/off key (OUT)

#### • Check of GPIB, USB and LAN

Make some of the setting changes described in the “Checks of important functions” section from GPIB, USB, and LAN. Verify that the output changes are the same.

In this case, [GPIB], [USB] or [LAN] will be displayed in the status display area at the top of the screen.

Check also that pressing the [Local] soft key while [GPIB], [USB] or [LAN] is displayed in the status display area clears the previous status display and returns to the local state (except when local lockout).

## 15.6 Performance Tests

### ■ Performance tests

The performance tests are carried out as a part of the preventive maintenance to prevent product performance from deteriorating.

Carry out the performance tests in the event of the need to perform an acceptance inspection, periodic inspection, or performance checks after repair.

If the results of the performance tests indicate that the product does not meet the specifications, repair is required. Contact NF Corporation or one of our representatives.

### ■ Checks before performance tests

Check the following before the performance tests.

- The power supply voltage is within the rated range.
- The ambient temperature is within the range of +20 to +30 °C.
- The ambient relative humidity is within the range of 20 to 70%RH.
- Non-condensing.
- The product was allowed to warm up for at least 30 minutes.

### ■ Preparations before performance tests

- As the signal cable, use a coaxial cable with a characteristic impedance of 50  $\Omega$ , thickness of RG-58A/U or more, and length of 1 m or less, and BNC connectors on both ends.
- For the items that 50  $\Omega$  termination is specified, set the input impedance to 50  $\Omega$  for the measuring instrument to be connected.
- For a measuring instrument that cannot be set to 50  $\Omega$  input, install a 50  $\Omega$  terminator (feed through terminator) at the input of the instrument.
- Measure a signal up to approx. 24 dBm (when the amplitude setting is 20 Vp-p/open). Use a coaxial attenuator separately if needed so as not to exceed the allowable input of the instrument. Note that a power meter (power sensor) and spectrum analyzer in particular are damaged easily.
- The setting information for each test item includes descriptions on items requiring additional changes after performing setting initialization (performing [Reset] in the Utility screen) and turning the output on.

### 15.6.1 Frequency Accuracy Test

Connection: FCTN OUT → Universal counter input (50  $\Omega$  termination)

Use a coaxial cable.

Setting: Set the frequency to 1 MHz and the amplitude to 10 Vp-p/open after setting initialization.

Measurement: Set the universal counter to the frequency measurement mode and measure the frequency.

## 15.6 Performance Tests

Judgment: Normal if the value falls within the following range.  
 However, the instrument may vary  $\pm 1$  ppm annually due to deterioration with age. For example, if one year has passed since the instrument was shipped, the extent of deterioration may be within  $\pm 2$  ppm (999.998 kHz to 1.000 002 MHz).

Rating range
0.999 999 MHz to 1.000 001 MHz

### 15.6.2 Sine Wave Amplitude Accuracy Test

Connection: FCTN OUT  $\rightarrow$  Digital multi-meter (AC voltage TrueRMS measurement)  
 Use a coaxial cable.  
 Setting: The following table shows the amplitude after setting initialization. (Frequency is set to 1 kHz).  
 Measurement: Measure the output voltage for each waveform as the effective value.  
 Judgment: Normal if the values fall within the ranges in the following table.

Amplitude settings (load open value)	Rating range
20Vp-p (7.071Vrms)	7.000Vrms $\sim$ 7.142Vrms
5Vp-p (1.768Vrms)	1.749Vrms $\sim$ 1.786Vrms
3Vp-p (1.061Vrms)	1.049Vrms $\sim$ 1.072Vrms
1Vp-p (353.6mVrms)	349.3mVrms $\sim$ 357.8mVrms
0.3Vp-p (106.1mVrms)	104.3mVrms $\sim$ 107.8mVrms
0.1Vp-p (35.36mVrms)	34.29mVrms $\sim$ 36.42mVrms
0.02Vp-p (7.071mVrms)	6.293mVrms $\sim$ 7.849mVrms

### 15.6.3 DC Offset Accuracy Test

■ DC only

Connection: FCTN OUT  $\rightarrow$  Digital multi-meter (DC voltage measurement)  
 Setting: Set the waveform to DC after setting initialization. The following table shows the DC offset settings.  
 Measurement: Measure the output voltage as DC.  
 Judgment: Normal if the values fall within the ranges in the following table.

DC offset settings (load open value)	Rating range
$\pm 10$ V	$\pm 9.895$ V $\sim$ $\pm 10.105$ V
$\pm 3$ V	$\pm 2.965$ V $\sim$ $\pm 3.035$ V
$\pm 1$ V	$\pm 0.9850$ V $\sim$ $\pm 1.0150$ V
$\pm 0.3$ V	$\pm 0.292$ V $\sim$ $\pm 0.308$ V
$\pm 0$ V	-5.000mV $\sim$ +5.000mV

■ AC+DC

- Connection: FCTN OUT → Digital multi-meter (DC voltage measurement)  
 Setting: Set the oscillation mode to BURST, burst mode to GATE, trigger to external (oscillation of sine wave is stopped at 0 degree) after setting initialization. The following table shows the amplitude. DC offset setting is left at 0 V.  
 Measurement: Measure the output voltage as DC.  
 Judgment: Normal if the values fall within the ranges in the following table.

振幅設定 (負荷開放値)	定格範囲
6.4Vp-p	-37.00mV ~ +37.00mV
3.5Vp-p	-22.50mV ~ +22.50mV
0.7Vp-p	-8.50mV ~ +8.50mV

15.6.4 Sine Wave Amplitude/Frequency Characteristics Test

■ 100kHz or lower

- Connection: FCTN OUT → Digital multi-meter (AC voltage TrueRMS measurement, and 50Ω termination)  
 Use a coaxial cable.  
 Setting: The following table shows the amplitude and frequency after setting initialization.  
 Measurement: Measure the output voltage for each frequency as the effective value.  
 Judgment: For each amplitude setting, normal if the measurement error for each frequency based on the measurement values at 1kHz falls within the range in the following table. (The right-most column of the table is used in the next section.)

Amplitude setting (Value at 50 Ω load)	Measured value at 1 kHz	Error at 50 kHz	Error at 100 kHz	Error of each amplitude at 100 kHz is as follows.
10 Vp-p	Reference value	±0.1 dB	±0.1 dB	X1(dB)
2.5 Vp-p	Reference value	±0.1 dB	±0.1 dB	X2(dB)
2.0 Vp-p	Reference value	±0.1 dB	±0.1 dB	X3(dB)
0.5 Vp-p	Reference value	±0.1 dB	±0.1 dB	X4(dB)
0.15 Vp-p	Reference value	±0.1 dB	±0.1 dB	X5(dB)
0.05 Vp-p	Reference value	±0.1 dB	±0.1 dB	X6(dB)

■ More than 100kHz

- Connection: FCTN OUT → Power meter (Power sensor)  
 Use a coaxial cable. Measure a signal up to approx. 24 dBm. Use a coaxial attenuator separately so as not to exceed the allowable input of the power sensor.  
 Setting: The following table shows the amplitude and frequency after setting initialization.  
 Measurement: Measure the output voltage or the power at each frequency.  
 Judgment: For each amplitude setting, normal if the measurement error for each frequency based on the measurement values at 100 kHz falls within the range in the following table.  
 Add the error Xn (n=1-to 6), previously measured at 100 kHz by the digital multi-meter, to the judgment range.  
 For example, when X1 is -0.05dB, the judgment range at 10Vp-p and 5MHz is -0.1dB to +0.2 dB.

## 15.6 Performance Tests

Amplitude setting (Value at 50 Ω load)	Measured value at 100 kHz	Error at 5 MHz	Error at 20 MHz	Error at 30 MHz	Error at 60 MHz
10 Vp-p	Reference value	-X1±0.15 dB	-X1±0.2 dB	-X1±0.5 dB	-X1±0.7 dB
2.5 Vp-p	Reference value	-X2±0.15 dB	-X2±0.2 dB	-X2±0.5 dB	-X2±0.7 dB
2.0 Vp-p	Reference value	-X3±0.15 dB	-X3±0.2 dB	-X3±0.5 dB	-X3±0.7 dB
0.5 Vp-p	Reference value	-X4±0.15 dB	-X4±0.2 dB	-X4±0.5 dB	-X4±0.7 dB
0.15 Vp-p	Reference value	-X5±0.15 dB	-X5±0.2 dB	-X5±0.5 dB	-X5±0.7 dB
0.05 Vp-p	Reference value	-X6±0.15 dB	-X6±0.2 dB	-X6±0.5 dB	-X6±0.7 dB

### 15.6.5 Sine Wave Total Harmonic Distortion Test

Connection: FCTN OUT → Audio analyzer (50Ω termination)

Use a coaxial cable. If the audio analyzer does not have a 50 Ω terminator, install a 50 Ω terminator (feed through terminator) at the input of the instrument.

Setting: Set frequency to 20 kHz after setting initialization. The following table shows the amplitude.

Measurement: Measure the harmonic distortion up to the 7th order THD<sub>7</sub>(%). (Not THD+N)  
When THD<sub>7</sub> cannot be measured directly, measure the harmonic distortion from the 2nd order to the 7th order (HD<sub>2</sub> to HD<sub>7</sub>) (%) and obtain THD<sub>7</sub> (%) through calculation.

$$THD_7 = \sqrt{HD_2^2 + HD_3^2 + HD_4^2 + HD_5^2 + HD_6^2 + HD_7^2}$$

Judgment: Normal if the value falls within the range in following table.

Amplitude setting (Value at 50 Ω load)	Total harmonic distortion (THD <sub>7</sub> )
2 Vp-p	0.03% or lower

**15.6.6 Sine Wave Harmonic Spurious Test**

- Connection: FCTN OUT → Spectrum analyzer  
 Use a coaxial cable. Measure a signal up to approx. 24 dBm. Use a coaxial attenuator separately so as not to exceed the allowable input of the spectrum analyzer.
- Setting: The following table shows the amplitude and frequency after setting initialization.
- Measurement: Measure the harmonic spurious up to the 5th order and obtain the total value of harmonic spurious through calculation.  
 Make the attenuator of the spectrum analyzer high until the relative level of the fundamental wave stabilizes. In addition, average the measurement values because they vary due to noise.  
 Using X2 to X5 (dBc) as the relative values of the harmonic spurious up to the 5th order based on the fundamental wave, the total harmonic spurious can be obtained with the following formula.

$$\text{Harmonic spurious} = \sqrt{10^{\frac{X2}{10}} + 10^{\frac{X3}{10}} + 10^{\frac{X4}{10}} + 10^{\frac{X5}{10}}}$$

Judgment: Normal if the values fall within the ranges in the following table.

Total value of the maximum harmonic spurious level up to the 5th order				
Amplitude setting (Value at 50 Ω load)	Frequency setting 1 MHz	Frequency setting 5 MHz	Frequency setting 30 MHz	Frequency setting 60 MHz
2 Vp-p	-65 dBc or less	-60 dBc or less	-46 dBc or less	-40 dBc or less

**15.6.7 Sine Wave Non-harmonic Spurious Test**

- Connection: FCTN OUT → Spectrum analyzer  
 Use a coaxial cable. Measure a signal up to approx. 24 dBm. Use a coaxial attenuator separately so as not to exceed the allowable input of the spectrum analyzer.
- Setting: The following table shows the amplitude and frequency after setting initialization.
- Measurement: Measure the non-harmonic spurious maximum value. Average the measurement values because they vary due to noise.
- Judgment: Normal if the value falls within the range in the following table.

Maximum non-harmonic spurious level			
Amplitude setting (Value at 50 Ω load)	Frequency setting 8 MHz	Frequency setting 30 MHz	Frequency setting 60 MHz
2 Vp-p	-70 dBc or less	-65 dBc or less	-65 dBc or less

**15.6.8 Square Wave Duty Accuracy Test**

- Connection: FCTN OUT → Universal counter (50 Ω termination)  
 Use a coaxial cable.
- Setting: Set the waveform to square wave and the amplitude to 20 V<sub>p-p</sub>/open after setting initialization. The following table shows the duty variable range setting, frequency setting, and duty setting.
- Measurement: Set the universal counter to duty measurement mode. Set the trigger level of the universal counter to 0 V. Average the measured values because they vary due to jitter (especially when extended duty variable range).
- Judgment: Normal if the values fall within the ranges following tables.

■ Standard duty variable range

Frequency	Duty		
300 kHz	When 1% is set 0.9% to 1.1%	When 50% is set 49.9% to 50.1%	When 99% is set 98.9% to 99.1%
3 MHz	When 5% is set 4% to 6%	When 50% is set 49% to 51%	When 95% is set 94% to 96%
10 MHz	When 40% is set 37% to 43%	When 50% is set 47% to 53%	When 60% is set 57% to 63%

■ Extended duty variable range

Frequency	Duty		
300 kHz	When 1% is set 0.9% to 1.1%	When 50% is set 49.9% to 50.1%	When 99% is set 98.9% to 99.1%
3 MHz	When 5% is set 4% to 6%	When 50% is set 49% to 51%	When 95% is set 94% to 96%
10 MHz	When 40% is set 37% to 43%	When 50% is set 47% to 53%	When 60% is set 57% to 63%

**15.6.9 Square Wave Leading/Trailing Time Test**

- Connection: FCTN OUT → Oscilloscope (50 Ω termination)  
 Use a coaxial cable.
- Setting: Set the waveform to square wave, the frequency to 5 MHz, and the amplitude to 4 V<sub>p-p</sub>/open after setting initialization. The following table shows the duty variable range.
- Measurement: Observe the waveform and measure the leading and trailing time.
- Judgment: Normal if the value falls within the range in the following table.

Duty variable range	Leading edge and trailing edge time
Standard	8.2 ns or less
Extended	8.2 ns or less

**15.6.10 Time Difference Between Channels for 2-Phase (WF1984 Only)**

- Connection: CH1 FCTN OUT → Universal counter input 1 (50 Ω termination)  
 CH2 FCTN OUT → Universal counter input 2 (50 Ω termination)  
 Use coaxial cables of the same length and type.
- Setting: Set the channel mode to 2PHASE, amplitude to 20 V<sub>p-p</sub>/open, phase of CH2 to 180 deg, and frequency to 10 MHz after setting initialization. The following table shows the waveform.  
 Perform the measurement by setting the phase difference to 180 deg. This is because the normal counter cannot measure a negative time difference. With this setting, a fixed offset time can be provided.
- Measurement: Measure the interval between CH1 and CH2 by setting the universal counter to the time interval mode of input 1 → input 2. Set the trigger level of the universal counter to 0 V and the trigger polarity to rising for CH1 and CH2.  
 Average the measurement values because they vary.
- Judgment: Normal if the values fall within the ranges in the following table.

Waveform	Rating range
Sine wave	50ns ±20ns
Square wave (standard duty variable range)	50ns ±20ns
Square wave (extended duty variable range)	50ns ±20ns



## 16. List of Initial Settings

16.1	Settings Related to Oscillator .....	16-2
16.2	Settings Related to Sequence Oscillation .....	16-3
16.3	Other Factory Default Settings .....	16-4

The settings can be initialized in the Utility screen. The settings of “16.1 Settings Related to Oscillator” are initialized with [Osc Rset], and the settings of “16.2 Settings Related to Sequence Oscillation” are initialized with [Seq Reset]. These items are also stored in the setting memory (except for the output on/off setting).

The operation mode, arbitrary waveform memory, setting memory, user-defined unit setting, output setting at power-on, panel operation setting, and remote setting are not initialized. The user-defined unit settings are not initialized, but they are stored in the setting memory.

## 16.1 Settings Related to Oscillator

### ■ Waveform output settings

Oscillation mode	Continuous oscillation
Waveform	Sine wave
Polarity and amplitude range	Normal, $\pm$ FS
Frequency	1 kHz
Amplitude	0.1 Vp-p
DC Offset	0 V
Range	Auto
Load impedance	Open
Phase	0°
Output	Off
Noise bandwidth	30 MHz

### ■ Waveforms

Square wave duty	Standard range, 50%
Pulse wave duty	50%
Pulse wave leading/trailing time	1 $\mu$ s
Lamp wave symmetry	50%

### ■ Sub output settings

Synchronization/sub output	Reference phase synchronization
Sub-waveform	Sine wave
Sub-waveform frequency	1 kHz
Sub-waveform phase	0°
Band when sub-waveform is noise	Full
Sub-waveform amplitude	0.1 Vp-p
Sub-waveform DC offset	0 V

### ■ Modulation

Modulation type	FM
FM peak deviation	100 Hz
FSK hop frequency	1.1 kHz
PM peak deviation	90°
PSK deviation	90°
AM modulation depth	50%
DC offset modulation peak deviation	0.1 V
PWM peak deviation	10%
Modulation source	Internal, sine wave, 100 Hz
FSK/PSK external modulation input polarity	Positive
Synchronization/sub-output	Internal modulation synchronization

### ■ Sweep

Sweep type	Frequency
Frequency sweep range	1 kHz to 10 kHz
Phase sweep range	-90° to 90°
Amplitude sweep range	0.1 Vp-p to 0.2 Vp-p

## 16 List of Initial Settings

DC offset sweep range	-0.1 V to 0.1 V
Duty sweep range	40% to 60%
Sweep time	100 ms
Sweep mode	Continuous
Trigger source	Internal, 1sec
External trigger input polarity	Negative
Sweep function	One way, linear
Each marker value	5 kHz, 0°, 0.15 Vp-p, 0 V, 50%
Stop level	Off, 0%
External control input	Disabled
Oscillation stop unit when gated single	Cycle
Synchronization/sub-output	Sweep synchronization, marker on
■ Burst	
Burst mode	Trigger burst
Mark wave number	1.0
Space wave number	1.0
Trigger source	Internal, 10 ms
External trigger input polarity	Negative
Trigger delay	0s
Stop level	Off, 0%
Oscillation stop unit when gate	Cycle
Synchronization/sub-output	Burst synchronization
■ Synclator	
Synclator	Off
Trigger source	Ext (WF1983),
CH1: Ext1, CH2: Ext2 (WF1948)	
External trigger input polarity	Positive
External trigger threshold	TTL
Dividing number m, multiplication number N	1, 1
■ 2 Channel Coordination (WF1984 only)	
Channel mode	Independent
Frequency difference	0 Hz
Frequency ratio	1:1
Same value setting	Off
■ Setting range limits	
Frequency upper limit	60 MHz
Frequency lower limit	0.01 μHz
High level	+10.5 V
Low level	-10.5 V
Phase upper limit	+1800 deg
Phase lower limit	-1800 deg
Duty upper limit	99.99%
Duty lower limit	0.01%
■ Others	
Use of user-defined unit	Cancel
External 10 MHz frequency reference input	Invalid
External 10MHz frequency reference output	Off
External addition	Off

### 16.2 Settings Related to Sequence Oscillation

- Step control parameters

Start step	1
Trigger polarity	Off
Noise bandwidth	30 MHz
External control input	Disabled
External control start/state branch	Start
Synchronization/sub-output	Step synchronization
Step time	1 s
Auto hold	Off
Jump destination	Off
Jump count	Infinite
Stop phase	Off
State branch	Off
Event branch	Off
Control at step terminate	Moving to the next step
Step code	LLLL
Intra-step operation	Constant

■ Intra-step channel parameters

Channel parameters	Equal to initial values of oscillator
--------------------	---------------------------------------

### 16.3 Other Factory Default Settings

The following settings are factory default settings for items not changed when setting initialization is performed.

■ Definition of user-defined unit

Operation mode	Oscillator
----------------	------------

■ Definition of user-defined unit

Unit name	usr1 to usr6
Formula	(h+n)*m
m	1
n	0

■ Output setting at power-on, panel operation settings

Output at power-on	Off
Display	Dark color
Modify direction	Downward by turning CW
Operation sound	On

■ Remote settings

Interfaces	USBTMC
GPIB address	2
IP address / Subnet mask	192.168.0.2/255.255.255.0

# 17. Specifications

17.1	Oscillation Mode .....	17-2
17.2	Waveform .....	17-2
17.3	Frequency and Phase .....	17-3
17.4	Output Characteristics .....	17-3
17.5	Main Signal Characteristics .....	17-5
17.6	Modulation Function .....	17-10
17.7	Sweep oscillation mode .....	17-11
17.8	Burst oscillation mode .....	17-13
17.9	Synclator Function .....	17-14
17.10	Triggers .....	17-14
17.11	Sequences .....	17-15
17.12	Other I/Os .....	17-15
17.13	2 Channel Coordination Operation (WF1984 Only) .....	17-17
17.14	Synchronization of Multiple Units .....	17-18
17.15	User-defined Units .....	17-18
17.16	Setting Value Upper and Lower Limit Function .....	17-18
17.17	Other Functions .....	17-19
17.18	External Storage .....	17-19
17.19	Remote Interfaces .....	17-19
17.20	Options .....	17-19
17.21	General Characteristics .....	17-19

Unless otherwise specified, the conditions are as follows: waveform output (FCTN OUT) is the target, oscillation is continuous, load is 50  $\Omega$ , amplitude setting is 10 Vp-p/50  $\Omega$ , DC offset setting is 0V, auto range for output voltage, amplitude range of waveform is  $\pm$ FS, external addition is off, and AC voltage is effective value measurement.

Numeric values marked as \*1 are guaranteed values. The other numeric values are not guaranteed values but nominal values or typical values (marked as typ.).

## 17.1 Oscillation Mode

Oscillation mode	Continuous, burst, sweep, sequence
Modulation function	In each of the continuous, burst, and sweep oscillation modes, modulations are possible simultaneously. However, in the sweep oscillation mode, modulations with the same parameters as the sweep type are not allowed. In other than auto burst mode, external FSK and PSK are not allowed.

## 17.2 Waveform

### 17.2.1 Standard Waveform

Types	Sine wave, square wave, pulse wave, ramp, parameter-variable wave, noise (gauss distribution), DC
Polarity	Normal, inverted (switchable) Except for DC
Amplitude range	-FS/0, $\pm$ FS, 0/+FS (switchable) Except for DC.

### 17.2.2 Arbitrary Waveform

Waveform length	16 words to 64 Mi words or 2 to 10 000 control points (linear interpolation is performed between control points)
Total amount of waveforms that can be saved	Approx. 4 Gi words (common for all channels) Saving of maximum of 4 096 waveforms (average waveform length 900 Ki word) Saving of 56 waveforms in full waveform length (64 Mi word)
Saved to non-volatile memory	Saving to USB flash memory is possible.
Resolution of waveform data amplitude	16 bit
Sampling rate	0 to 240 MS/s
Resolution	16 digits or 100 nS/s
Polarity	Normal, inverted (switchable)
Amplitude range	-FS/0, $\pm$ FS, 0/+FS (switchable)
Output bandwidth	40 MHz (-3 dB) when 240 MS/s

## 17.3 Frequency and Phase

### Frequency setting range

Limited to the smaller of the ranges determined by the waveforms that are output.

When the synclator function is enabled, the available frequency range of oscillation is limited to 30 Hz to 5 MHz.

Oscillation Mode Waveform	Continuous, modulated, sweep (continuous and single)	Sweep (gated single), Burst	Sequences
Sine wave	0 to 60 MHz	0 to 20 MHz	0 to 20 MHz
Square wave	0 to 30 MHz	0 to 20 MHz	0 to 20 MHz
Pulse Wave	0 to 30 MHz	0 to 20 MHz	Not available
Ramp Wave	0 to 10 MHz		0 to 10 MHz
Parameter-Variable Waveform	0 to 5 MHz		0 to 5 MHz * <sup>2</sup>
Noise	Equivalent bandwidth Select from 100 kHz/300 kHz/1 MHz/3 MHz/10 MHz/30 MHz/FULL * <sup>3</sup>		
DC	Frequency setting is invalid		
Arbitrary Waveform	0 to 15MHz (limited by the number of samples and sampling rate)		

\*<sup>2</sup>: This is used by converting into an arbitrary waveform.

\*<sup>3</sup>: FULL is approx. 70MHz.

Frequency setting resolution  
Frequency setting with period

0.01  $\mu$ Hz (< 50 MHz), 0.1  $\mu$ Hz ( $\geq$  50 MHz )  
Setting with frequency that is inverse number of set period  
Less than 0.01  $\mu$ Hz is rounded off

Frequency accuracy at shipment \*<sup>1</sup>  
Frequency aging rate \*<sup>1</sup>  
Setting range of phase

$\pm$ (1 ppm of setting + 4 pHz)  
 $\pm$ 1 ppm/year  
-1 800.000° to +1 800.000° (resolution 0.001°)

## 17.4 Output Characteristics

### 17.4.1 Amplitude

Setting range

0 Vp-p to 21 Vp-p/open, 0 Vp-p to 10.5 Vp-p/50  $\Omega$   
A peak value combining waveform amplitude and DC offset is limited to  $\pm$ 10.5 V/open or less.

Setting resolution

0.1 mVp-p (2.999 9 Vp-p or less)/open

Accuracy\*<sup>1</sup>

1 mVp-p (3.000 Vp-p or more)/open  
 $\pm$  (1% of amplitude setting [Vp-p] + 2 mVp-p)/open  
Conditions: Continuous oscillation, 1 kHz sine wave, amplitude setting 20 mVp-p to 20 Vp-p/open, DC offset setting 0 V, auto range, external addition off, and effective value measurement

Setting unit

Vp-p, Vpk, Vrms, dBV, dBm  
Vp-p is applied to the standard waveforms and arbitrary waveform with amplitude range of  $\pm$ FS.  
Vpk is applied to the standard waveforms and arbitrary waveforms with amplitude range of -FS/0 or 0/+FS.  
Vrms, dBV, and dBm are applied to sine wave and noise only.  
0 dBV will be 1 Vrms.

Range

Regarding dBm, voltage that is 1 mW at the specified load impedance (excluding High-Z) will be 0 dBm.  
Auto, hold (switchable)  
Maximum output voltage range: 20 Vp-p, 4 Vp-p, 0.8 Vp-p  
Amplitude attenuator range: 0 dB, -10 dB, -20 dB, -30 dB

Resolution of waveform amplitude

Approx. 16 bit  
Conditions: Amplitude setting 8 mVp-p/open or more, DC offset setting 0 V, auto range, external addition off, and standard waveform with amplitude range of  $\pm$ FS.

## 17.4.2 DC Offset

Setting range	$\pm 10.5$ V/open, $\pm 5.25$ V/50 $\Omega$ A peak value combining waveform amplitude and DC offset is limited to $\pm 10.5$ V/open or less.
Setting resolution	0.1 mV ( $-2.9999$ V to $2.9999$ V)/open 1 mV ( $-3.000$ V or less and $3.000$ V or more)/open
Accuracy*1	$\pm (  1\% \text{ of DC offset setting [V]}   + 5 \text{ mV} + 0.5\% \text{ of amplitude setting [Vp-p]})/\text{open}$ Conditions: when sine wave output of 10 MHz or less, load open, auto range, external addition off, and 20 °C to 30 °C. When 1 mV/°C typ and 2 Vp-p will be exceeded with an amplitude setting of 2 Vp-p outside of the temperature range of 20 °C to 30 °C, add 2 mV/°C typ.
Range	0 dB, -14 dB

## 17.4.3 Load Impedance Setting

Function	Set and display the amplitude and DC offset at the output terminal voltage under the specified load condition.
Setting range	1 $\Omega$ to 10 k $\Omega$ (resolution 4 digits or 0.1 $\Omega$ ), 50 $\Omega$ , High-Z (load open)

## 17.4.4 Waveform Output

Output on/off control	On, off (switchable) Output terminal is in an open condition when off
Output impedance	50 $\Omega$ , unbalanced
Short-circuit protection	Protection against short circuit with signal GND
Output connector	Front panel, BNC receptacle

## 17.4.5 Synchronization/Sub-output (SYNC/SUB OUT)

Output signals	Reference phase synchronization, burst synchronization, sweep synchronization, sequence step synchronization, sub-waveform, internal modulation synchronization, and off (switchable)
Reference phase synchronization	Square wave with duty 50% rising at zero degree of reference phase (DDS oscillation phase) of the waveform output.
Sub-waveform	Analog waveform output independent from the main-output Frequency, phase, amplitude, and offset are also adjustable.
Available waveform	Sine wave, square wave (duty 50%), triangle wave (symmetry 50%), rising ramp, falling ramp wave, noise, arbitrary wave, parameter-variable waveform
Setting frequency range	0 to 5 MHz (resolution 0.01 $\mu$ Hz)
Internal modulation waveform	Modulation waveform at the time of internal modulation oscillation Amplitude and offset are also adjustable independent from the modulation depth.
Output voltage	Each type of synchronized signal: TTL level (low level 0.4 V or less, high level 2.7 V/open or more) Sub-waveform/Internal modulation waveform: -3.3 V to +3.3 V/open
Phase setting range	$-180.000^\circ$ to $+180.000^\circ$ (resolution 0.001 $^\circ$ ) When sub-waveform and internal modulation waveform are selected. Phase represents the phase of waveform output with respect to reference phase synchronization.
Output impedance	50 $\Omega$ , unbalanced



Load impedance 50 Ω or more  
 Output connector Front panel, BNC receptacle

## 17.5 Main Signal Characteristics

### 17.5.1 Sine wave

#### Amplitude frequency characteristics\*1

100 kHz or less ±0.1 dB	
100 kHz to 5 MHz	±0.15 dB
5 MHz to 20 MHz	±0.3 dB
20 MHz to 30 MHz	±0.5 dB
30 MHz to 60 MHz	±0.7 dB

Conditions: Continuous oscillation, 50 Ω load, DC offset setting 0 V, amplitude setting 50 mVp-p to 10 Vp-p/50 Ω, auto range, external addition off, effective value measurement, frequency 1kHz reference

Total harmonic distortion  
 10 Hz to 20 kHz

0.03% or less typ

Conditions: Continuous oscillation, 50 Ω load, DC offset setting 0 V, amplitude setting 2 Vp-p/50 Ω, auto range, external addition off, synchronization/sub-output off, sum up to 7th harmonic, noise is not included.

#### Harmonic spurious

1 MHz or less	-65 dBc or less typ
10 MHz or less	-60 dBc or less typ
10 MHz to 60 MHz	-60 dBc + 20 dB/dec or less typ

Conditions: Continuous oscillation, 50 Ω load, amplitude setting 2 Vp-p/50Ω, DC offset setting 0V, auto range, external addition off, synchronization/sub-output off

#### Non-harmonic spurious

10 MHz or less	-70 dBc or less typ
10 MHz to 60 MHz	-65 dBc or less typ

Conditions: Continuous oscillation, 50 Ω load, DC offset setting 0V, amplitude setting 2 Vp-p/50 Ω, synchronization/sub-output off

### 17.5.2 Square wave

#### Duty

Variable range switching

Conditions:

Standard, extended (switchable)

Duty can be changed within the range where jitter is low and a pulse does not disappear. The setting range of the duty narrows as the frequency rises. Duty setting range with 30 MHz

Approx. 36% to 64%

Extended range:

There is jitter of 1.3ns rms or less typ., and the duty can be always changed at the maximum range. When the pulse width is narrower than 4.2ns, pulses may disappear. When the frequency is not 1/(integer) of 240 MHz, it becomes equal to the specified duty on average.

#### Setting range

Standard range

0.000 0% to 99.999 9% (resolution 0.000 1%)

Upper limit (%):  $100 - \text{Frequency (Hz)} \times 115 / 96\,000\,000$

Lower limit (%):  $\text{Frequency (Hz)} \times 115 / 96\,000\,000$

Extended range

0.000 0% to 100.000 0% (resolution 0.000 1%)

Duty accuracy*1	±0.1% of period (duty setting is 1% to 99%)
Up to 100 kHz	±1% of period (duty setting is 5% to 95%)
100 kHz to 1 MHz	±3% of period (duty setting is 40% to 60%)
1 MHz to 3 MHz	8.0ns or less typ, but when continuous oscillation mode
Leading/trailing edge time	2% or less typ.
Overshoot	Duty variable range standard 40 ps rms or less typ. (100 Hz or more)
Jitter	Duty variable range extended 1.3 ns rms or less typ.

### 17.5.3 Pulse Wave

Available edge waveform Transition part of the pulse is selectable from cosine, linear, parameter-variable waveform, and arbitrary waveform. For details, refer to the table below.

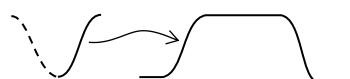
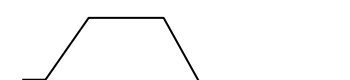
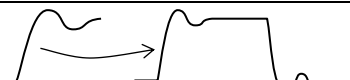
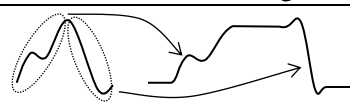
Edge waveform	Description	Output waveform
Cosine	Rising: 180° to 360° of cosine waveform Falling: Waveform with rising inverted	
Linear	Rising and falling are both linear	
Parameter-Variable Waveform	Rising: Selected parameter-variable waveform Falling: Waveform with rising inverted	
Arbitrary Waveform	Rising: First half of selected arbitrary waveform Falling: Second half of selected arbitrary waveform	

Pulse width*4	0.000 1% to 99.999 9% (resolution 0.000 1%)
Duty setting range	20 ns to 99.999 9 Ms (resolution 0.000 1% or less of period or 0.01 ns)
Period setting range	
Leading edge time, trailing edge time*4	7.70 ns to 59.03 Ms (resolution 4 digits or 0.01 ns)
Setting range	Independent setting of leading and trailing edge times
Minimum setting value	0.000 1% of period or 7.70 ns, whichever is larger
Limitations on pulse width time, leading edge time, and trailing edge time*4	The pulse width time, leading edge time, trailing edge time, and period are mutually limited according to the following expression. The duty is calculated by pulse width time ÷ period.
	$\text{Pulse width time} \geq (\text{leading edge time} + \text{trailing edge time}) \times 0.85$
	$\text{Pulse width time} \leq \text{period} - (\text{leading edge time} + \text{trailing edge time}) \times 0.85$
Overshoot *4	2% or less typ.
Jitter *4	40 ps rms or less typ. (100 Hz or more)
	1.3 ns rms or less typ. (less than 100 Hz)
	Condition: Leading edge time setting 7.7 ns

\*4: When the edge waveform is cosine

### 17.5.4 Ramp Wave

Setting range of symmetry 0.00% to 100.00% (resolution 0.01%)

## 17.5.5 Parameter-variable Waveform

### a) Steady sine group

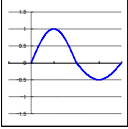
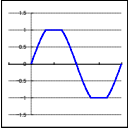
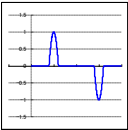
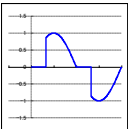
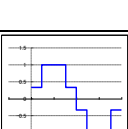
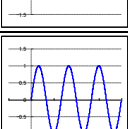
Waveform name	Waveform example	Overview and variable parameters
Unbalance sine		Waveform for which the amplitudes of the first half cycle and second half cycle of a sine wave can be changed independently
		First half amplitude (-100.00% to 100.00%) Second half amplitude (-100.00% to 100.00%)
Clipped sine wave		Waveform acquired by clipping the top and bottom of the amplitude of a sine wave
		Clip ratio (0.00% to 99.99%)
CF controlled sine wave		Waveform acquired by extracting only the neighborhood of 90° and 270° of a sine wave and expanding the amplitude
		Crest factor (1.41 to 10.00)
Angle controlled sine wave		Waveform acquired by extracting only the front or back portion of each half cycle of a sine wave
		Conduction angle (-180.00° to 180.00°) Remark: A back conduction angle if the conduction angle is positive, and a front conduction angle if it is negative.
Staircase sine wave		Staircase shaped sine wave
		Number of horizontal axis steps (2 to 256 or infinite) Number of vertical axis steps (2 to 1024 or infinite)
Multiple-cycle sine wave		Waveform acquired by continuing the sine wave for multiple cycles
		No. of cycles (0.01 to 50.00) Start phase (-360.00° to 360.00°)

### b) Transient sine group

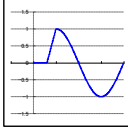
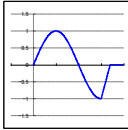
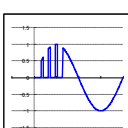
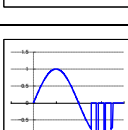
Waveform name	Waveform example	Overview and variable parameters
On-phase controlled sine wave		Sine wave with a slope into the on state
		On completion phase (0.00° to 360.00°) On slope time (0.00% to 50.00 % of basic period)
Off-phase controlled sine wave		Sine wave with a slope into the off state
		Off start phase (0.00° to 360.00°) Off slope time (0.00% to 50.00 % of basic period)
Chattering-on sine wave		Sine wave with chattering into the on state
		On start phase (0.00° to 360.00°) Number of chattering (0 to 20) On time (0.00% to 20.00% of basic period) Off time (0.00% to 20.00% of basic period)
Chattering-off sine wave		Sine wave with chattering into the off state
		Off start phase (0.00° to 360.00°) Number of chattering (0 to 20) On time (0.00% to 20.00% of basic period) Off time (0.00% to 20.00% of basic period)

**c) Pulse group**

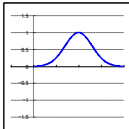
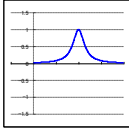
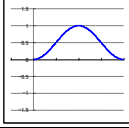
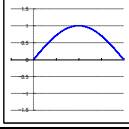
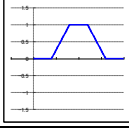
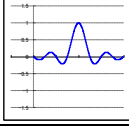
Waveform name	Waveform example	Overview and variable parameters
Gaussian pulse		Waveform with a Gaussian distribution
		Standard deviation (0.01% to 100.00% of basic period)
Lorentz pulse		Lorentz waveform
		Half value width (0.01% to 100.00% of basic period)
Haversine		$\text{Sin}^2$ pulse
		Width (0.01% to 100.00% of basic period)
Half-sine pulse		Sine wave half cycle pulse
		Width (0.01% to 100.00% of basic period)
Trapezoid pulse		Trapezoid waveform pulse
		Slope width (0.00% to 50.00% of basic period) Upper base width (0.00% to 100.00% of basic period)
Sin(x)/x		Sin(x)/x waveform
		Number of zero crossings (1 to 50)

**d) Transient response group**

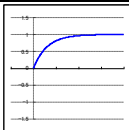
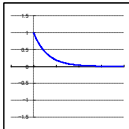
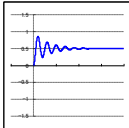
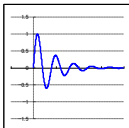
Waveform name	Waveform example	Overview and variable parameters
Exponential rise		First order LPF step response waveform
		Time constant (0.01% to 100.00% of basic period)
Exponential fall		First order HPF step response waveform
		Time constant (0.01% to 100.00% of basic period)
Second order LPF step response		Second order LPF step response waveform
		Natural frequency of LPF (1.00 to 50.00 times fundamental frequency) LPF Q (0.50 to 50.00)
Damped oscillation		Oscillation waveform with an amplitude that dampens exponentially
		Oscillation frequency (0.01 to 50.00 times fundamental frequency) Damped oscillation time constant (-100.00% to 100.00% of basic cycle) Remark: If the damped oscillation time constant is negative, an oscillation waveform with an amplitude that increases exponentially.

**e) Surge group**

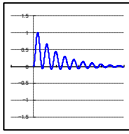
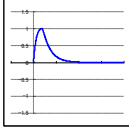
Waveform name	Waveform example	Overview and variable parameters
Oscillation surge		Surge waveform with damped oscillation
		Oscillation frequency (0.01 to 50.00 times fundamental frequency) Damped oscillation time constant (0.01% to 100.00% of basic cycle) Trailing edge time constant (0.01% to 100.00% of basic period)
Pulse surge		Pulse surge waveform
		Leading edge time (0.01% to 100.00% of basic period) Time duration (0.01% to 100.00% of basic cycle) The leading edge time is the time that the amplitude rises from the 10% to the 90%, and time duration is the pulse width with an amplitude of 10% or greater.

**f) Other group**

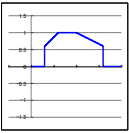
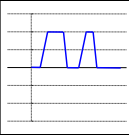
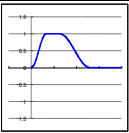
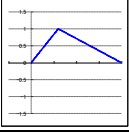
Waveform name	Waveform example	Overview and variable parameters
Trapezoid wave with offset		Trapezoid wave with offset in the amplitude direction
		Leading edge delay (0.00% to 100.00% of basic period) Rising slope width (0.00% to 100.00% of basic period) Upper base width (0.00% to 100.00% of basic period) Falling slope width (0.00% to 100.00% of basic period) Offset (0.00% to 100.00%)
Double pulse		Double wave pulse for which rising and falling of the pulse are the same
		Leading edge time (0.00% to 100.00% of basic period) Trailing edge time (0.00% to 100.00% of basic period) Lower base time 1 (0.00% to 100.00% of basic period) Upper base time 1 (0.00% to 100.00% of basic period) Lower base time 2 (0.00% to 100.00% of basic period) Upper base time 2 (0.00% to 100.00% of basic period)
Half-sine edge pulse		Pulse whose rise and fall are half-sine waveform
		Leading edge time (0.00% to 100.00% of basic period) Trailing edge time (0.00% to 100.00% of basic period) Duty (0.00% to 100.00%)
Bottom referenced ramp		Ramp waveform with bottom level as reference
		Symmetry (0.00% to 100.00%)

## 17.6 Modulation Function

### 17.6.1 General

Modulation type	FM, FSK, PM, PSK, AM, DC offset modulation and PWM PM and PSK are not possible for parameter-variable waveform and arbitrary waveform
Modulation operation	Start and stop
Modulation source	Internal, external (switchable) External modulation of FSK and PSK uses an external trigger input terminal.
Internal modulation waveform	
Except for FSK, PSK	Sine wave, square wave (duty 50%), triangle wave (symmetry 50%), rising ramp wave, falling ramp wave, noise, arbitrary waveform
FSK, PSK	Square wave (duty 50%)
Noise equivalent bandwidth	Select from 100 kHz/300 kHz/1 MHz/3 MHz/10 MHz/30 MHz/FULL
Internal modulation frequency	0 to 5 Mhz (Resolution 0.01 $\mu$ Hz)
Internal modulation synchronization output	
Output waveform	A square wave with duty 50% rising at the zero phase of the internal modulation waveform When internal modulation waveform is noise, the level is fixed to low.
Output connector	Shared with synchronization/sub-out connector (SYNC/SUB OUT)
Internal modulation waveform output	
Output voltage	-3.3 V to +3.3 V/open
Output connector	Shared with synchronization/sub-out connector
External modulation input (except for FSK and PSK)	
Input voltage range	$\pm 1$ V full scale
Maximum allowable input	$\pm 2$ V
Input impedance	10 k $\Omega$ , unbalanced
Input frequency	DC to 50 kHz (-3 dB)
Input connector	Front panel (WF1983) / rear panel (WF1984), BNC receptacle Shared with external addition input. Simultaneous use with the addition operation is not possible. Shared with channel 1 and channel 2 (WF1984)
External modulation input (FSK and PSK)	
Polarity	Positive, negative (switchable)
Input frequency	DC to 5 MHz
Input connector	Use external trigger input terminal. Input voltage and input impedance depend on external trigger input specification.
Simultaneous use with burst and sweep	Some modulation is possible in the burst and sweep oscillation modes. For details, refer to “17.7 Sweep Oscillation Mode” and “17.8 Burst Oscillation Mode.”

### 17.6.2 Modulation Conditions

#### ■ FM

Carrier waveform	Arbitrary waveforms and standard waveforms except for noise, pulse wave, and DC
Peak deviation setting range	0.00 $\mu$ Hz to less than 30 MHz (resolution 8 digits or 0.01 $\mu$ Hz) Carrier frequency $\pm$ peak deviation is limited within the allowable range of frequency for each carrier waveform.

#### ■ FSK

Carrier waveform	Arbitrary waveforms and standard waveforms, except for noise, pulse wave, and DC
Hop frequency setting range	Within the allowable range of frequency for each carrier waveform (resolution 8 digits or 0.01 $\mu$ Hz).

<b>■ PM</b>	
Carrier waveform	Arbitrary waveforms and standard waveforms except for parameter-variable waveforms, noise, and DC
Peak deviation setting range	0.000° to 180.000° (resolution 0.001°)
<b>■ PSK</b>	
Carrier waveform	Arbitrary waveforms and standard waveforms except for parameter-variable waveforms, noise, and DC
Setting range of deviation	-1 800.000° to +1 800.000° (resolution 0.001°)
Remark	Amplitude frequency characteristic of sine wave during PSK is limited to 25 MHz -3 dB.
<b>■ AM (non DSB-SC)</b>	
Carrier waveform	Arbitrary waveforms and standard waveforms except for DC
Modulation depth setting range	0.00% to 100.00% (resolution 0.01%)
Remark	When the modulation depth is 0%, amplitude becomes equal to 1/2 of setting.
<b>■ AM (DSB-SC) (double side band - suppressed carrier)</b>	
Carrier waveform	Arbitrary waveforms and standard waveforms except for DC
Modulation depth setting range	0.00% to 100.00% (resolution 0.01%)
Remark	When the modulation depth is 100%, maximum amplitude becomes equal to setting. The component of the carrier frequency is zero during DSB-SC.
<b>■ DC offset modulation</b>	
Carrier waveform	Arbitrary waveforms and standard waveforms
Peak deviation setting range	0 V~10.5 V/open Carrier DC offset ± peak deviation is limited within the allowed setting range of DC offset for each carrier waveform.
Peak deviation setting resolution	less than 3 V 5 digits or 0.1 mV 3 V or more 4 digits or 1 mV
<b>■ PWM</b>	
Carrier waveform	Square wave and pulse wave
Peak deviation setting range	
Square wave	0.000 0% to 50.000 0% (Resolution 0.000 1%)
Pulse Wave	0.000 0% to 49.999 9% (resolution 0.000 1%)
	Carrier duty ± peak deviation is limited within the allowable range of duty for each carrier waveform.

## 17.7 Sweep oscillation mode

### 17.7.1 General

Sweep type	Waveforms except arbitrary waveforms and parameter-variable waveforms Frequency, phase, amplitude, DC offset, and duty
Sweep function	Arbitrary waveforms, parameter-variable waveforms Frequency, amplitude, and DC offset One way (ramp waveform), shuttle (triangular waveform) (switchable) Linear, logarithmic (switchable) Common regardless of sweep type. However, logarithmic can use only frequency sweep.
Sweep range setting	Specify start value and stop value, or center value and span value However, the center value is also a simple average of the start value and stop value during frequency logarithmic sweep.
Sweep time setting range	0.1 ms to 10 000 s (resolution 5 digits or 10 μs) Common regardless of sweep type
Limitations of modulation function	Modulation except sweep type is available

Sweep mode	Continuous, single, gated single (switchable) Common regardless of sweep type. For gated single, it oscillates only while sweep is running. However, when the waveform is DC, gated single is not available.
Operation	Start, stop, hold, resume, start value output and stop value output.
Trigger source (used for single sweep and gated single sweep)	Internal, external (switchable) Common regardless of sweep type. Trigger delay setting is disabled. Manual trigger available.
Internal trigger oscillator for sweep (used for single sweep and gated single sweep)	
Period setting range	0.1 $\mu$ s to 10 000 s (resolution 7 digits or 2.5 ns)
Stop level setting (used for gated single sweep)	
Function	Specifies the signal level when gated single-sweep is stopped.
Setting range	-100.00% to +100.00% (amplitude full-scale reference and resolution 0.01%) or off When stop level is set to off, stops by set oscillation start/stop phase. Common regardless of sweep type.
Oscillation stop unit when gated single	Cycle, Half Cycle (switchable)
Sweep synchronization/marker output	
Marker off at one-way	Low level is used from sweep start value to half of sweep time. Otherwise, high level
Marker off at shuffle	Low level is used from sweep starting value to sweep stop value. Otherwise, high level
Marker on	Low level is used from sweep start value to marker value. High level, otherwise
Output connector	Shared with synchronization/sub-out connector
Sweep external control input	
Input connector	Use 3-bit of multi-I/O connector
Control items	Start, stop, hold/resume With WF1984, this is shared by two channels, and enable and disable can be set separately for each channel.
Sweep external trigger input (used for single sweep and gated single sweep)	
Polarity	Positive, negative, disable (switchable)
Input connector	Use external trigger input terminal Input voltage and input impedance depend on external trigger input specification

## 17.7.2 Sweep Conditions

### ■ Frequency Sweep

Waveform	Arbitrary waveforms and standard waveforms except for noise, pulse wave, and DC
Setting range of start and stop frequency	0 to 60 MHz Resolution: 0.01 $\mu$ Hz (<50 MHz), 0.1 $\mu$ Hz (50 MHz $\leq$ ) Limited within the allowable setting range of frequency for each waveform.

### ■ Phase Sweep

Waveform	Standard waveforms except for parameter-variable waveforms, noise, and DC
Setting range of start and stop phase	-1 800.000° to 1 800.000° (resolution 0.001°)

### ■ Amplitude Sweep

Waveform	Arbitrary waveforms and standard waveforms except for DC
Setting range of start and stop amplitude	0 Vp-p to 21 Vp-p/open Limited within the allowable setting range of amplitude for each waveform.
Setting resolution of start and stop amplitude	less than 3 mVp-p    5 digits or 0.1 mVp-p 3 Vp-p or more        4 digits or 1 mVp-p



## ■ DC Offset Sweep

Waveform	Arbitrary waveforms and standard waveforms
Setting range of start and stop DC offset	-10.5 V to +10.5 V/open Limited within the allowable setting range of DC offset for each waveform.
Setting resolution of start and stop DC offset	less than $\pm 3$ V                      5 digits or 0.1 mV $\pm 3$ V or more 4 digits or 1 mV

## ■ Duty Sweep

Waveform	Square wave and pulse wave
Setting range of start and stop duty	
Square wave	0.000 0% to 100.000 0% (Resolution 0.000 1%)
Pulse wave	0.000 1% to 99.999 9% (resolution 0.000 1%)
	Limited within the allowable setting range of duty for each waveform.

## 17.8 Burst oscillation mode

Burst mode	
Auto burst	Repeats oscillation for the number of mark waves and oscillation stop for the number of space waves. Trigger is disabled.
Trigger burst	Oscillates the number of mark waves in synchronization with a trigger.
Gate	Oscillates integer multiples in cycles or half-cycles, in synchronization with the gate signal However, when the waveform is noise, it turns oscillation on/off by gate signal.
Triggered gate	Gate oscillation, that toggles the gate on and off for each trigger.
Target waveform	
Auto, trigger burst	Arbitrary waveforms and standard waveforms except for noise and DC
Gate, triggered burst	Arbitrary waveforms and standard waveforms except for DC
Mark wave number setting range	0.5 to 999 999.5 cycles, in 0.5-cycle units or $\infty$ However, in 1-cycle units with parameter-variable waveforms and arbitrary waveforms.
Space wave number setting range	0.5 to 999 999.5 cycles, in 0.5-cycle units However, in 1-cycle units with parameter-variable waveforms and arbitrary waveforms.
Oscillation stop unit at gate	1-cycle units, 0.5-cycle units (switchable)  However, in 1-cycle units with parameter-variable waveforms and arbitrary waveforms.
Setting range of start/stop oscillation phase	$-1\ 800.000^\circ$ to $+1\ 800.000^\circ$ (resolution 0.001 $^\circ$ ) Remark: The same setting value as the phase setting in Section 3.3
Stop level setting range	
Function	Specifies the signal level when oscillation is stopped.
Setting range	-100.00% to +100.00% (amplitude full-scale reference and resolution 0.01%) or off When stop level is set to off, stops by set oscillation start/stop phases.
Trigger source (used for other than auto burst)	Internal, external (switchable) Manual trigger available.
Internal trigger oscillator for burst (used except for auto burst)	
Period setting range	0.1 $\mu$ s to 10 000 s (resolution 7 digits or 2.5 ns)
Burst external trigger input (used except for auto burst)	
Polarity	Positive, negative, disable (switchable)
Input connector	Use external trigger input terminal. Input voltage and input

Trigger delay setting range	impedance depend on external trigger input specification 0.00 $\mu$ s to 1 000 s (resolution 8 digits or 100 ps) Latent delay approx. 0.48 $\mu$ s Enabled only for trigger burst (disabled for gate and triggered gate) and enabled for internal, external, and manual triggers.
Trigger jitter	300 ps rms or less typ. (setting frequency 100 Hz or more)
Burst synchronization output	
Polarity	Low level during oscillation. High level, otherwise
Output connector	Shared with synchronization/sub-out connector
Limitations of modulation function	No limitations in auto burst mode. FSK/PSK are available only in auto burst mode.

## 17.9 Synclator Function

Synclator function	Function to make the frequencies of the signal input from the synchronization source and the signal output to the main output automatically become the same or multiplication ratio $n \div$ frequency division ratio $m$ . The frequency of the input signal is displayed on the screen. Modulation except frequency and auto burst are also possible.
Input frequency range	30 Hz $\times m$ to 5 MHz $\div n$ ( $m$ : frequency division ratio, $n$ : multiplication ratio)
Output frequency range	30 Hz to 5 MHz
Setting ranges of frequency division ratio $m$ and multiplication ratio $n$	1 to 64 (for each of $m$ and $n$ )
Input connector	External trigger input terminal Trigger delay setting is disabled.
Phase difference	Others depend on external trigger input specification The phase between the input external signal and the signal that is output to the waveform output can be set freely in the phase setting (however, due to internal processing, it will not become the same phase even with the 0° setting, and if the frequency is high, the phase shift will become large).
Limitations	<ul style="list-style-type: none"> <li>• Not available when sweep, frequency modulation, and burst except auto and when the waveform is noise, DC, and pulse.</li> <li>• Not available together with the sequence function (section 17.11)</li> <li>• Not available when channel coordination operation (section 3.13) is constant frequency difference and constant frequency ratio</li> </ul>

## 17.10 Triggers

External trigger input	
Usage	For single sweep, gated single sweep, trigger burst, gate, trigger gate, sequence, and synclator function
Input voltage	TTL level (low level 0.8 V or lower, high level 2.6 V or higher) or variable (threshold variable range $-5.0$ V to $+5.0$ V, and resolution 0.1 V)
Maximum allowable input	$-7$ V to $+7$ V
Polarity	Positive, negative, or off (switchable) (Off is not available for synclator.) Each setting is independent for FSK/PSK, sweep, sequence, and synclator.
Minimum pulse width	50ns
Input impedance	10 k $\Omega$ , unbalanced (pull up to approx. $+3$ V when TTL level, and pull down to GND when synclator function)
Input connector	Front panel (WF1983) / rear panel (WF1984), BNC receptacle
Manual trigger	Panel key operation
Usage	For single sweep, gated single sweep, trigger burst, gate, and trigger gate (Not available for synclator)

Internal trigger oscillator	Common for sweep and burst See the internal trigger oscillation in each section. (Not available for synclator)
-----------------------------	--

## 17.11 Sequences

Number of sequences saved	99 sets (saved to non-volatile memory) Saving to USB flash memory is possible.
Maximum number of steps	1023 steps at a maximum per sequence (the steps before start are excluded)
Interoperability between channels	Sequence mode is applied both channels in the sequence mode. Step control is shared
Step control parameters	Step time, hold operation, jump destination, jump count, step end phase, branch operation, step termination control, step synchronization code output
Intra-step channel channel parameter	Waveform, frequency, phase, amplitude, DC offset and square wave duty
Intra-step operation	Constant, keep, linear interpolation (excluding waveform switching)
Sweep time setting range	0.1 ms to 1 000 s (resolution 5 digits or 0.01 ms)
Jump count setting range	1 to 9 999 or infinite
Step end phase setting range	0.000° to 360.000°(CH1 reference phase. resolution 0.001°) or disabled Sine wave and triangle wave (symmetry 50%) can be set, fixed phase setting for arbitrary waveform
Branch operation	
State branch	Check the state branch input via the multi-I/O connector at step end. Branches to the specified step when the branch is detected.
Event branch	Immediately branches to the specified step by event branch operation or input.
Control at step end	Stop or move to the next step
Step synchronization code output	4-bit code specified for each step is output to the multi-I/O connector In addition, LSB can be output to the synchronization/sub output connector (SYNCOUT/SUB OUT).
Available waveforms	Sine wave, square wave, noise, and arbitrary waveform Ramp waves and variable parameter waveforms can be used by saving them as arbitrary waveforms
Maximum number of waveforms	1023 (each channel)
Phase at step start	Next step of DC or noise (except DC or noise) starts oscillation from each channel reference phase 0°
Sequence operation	Start, stop (immediate, in steps), hold/resume, and event branch
Sequence external control	
Input connector	Use 4-bit of multi-I/O connector
Control items	Start or state branch, stop, hold/resume, event branch
Sequence external trigger input (start trigger)	
Polarity	Positive, negative or off (switchable)
Input connector	Use external trigger input terminal of CH1 side Input voltage and input impedance depend on external trigger input specification
External addition	Combined use is possible
Limitations	Use with synclator function is not available

## 17.12 Other I/Os

External 10 MHz frequency reference input	
Frequency reference selection	External reference enable, disable (switchable)
Input voltage	0.5 Vp-p to 5 Vp-p
Maximum allowable input	10 Vp-p
Input impedance	300 Ω, unbalanced, AC coupled
Input frequency	10 MHz (±0.5% (±50 kHz))
Input waveform	Sine or square wave (50±5% duty)

Input connector	Rear panel, BNC receptacle
Frequency reference output	
Function	For synchronization of multiple units
Output voltage	1 V <sub>p-p</sub> /50 Ω square wave
Output impedance	50 Ω, AC coupled
Output frequency	10 MHz (synchronization signal is also output)
Output connector	Rear panel, BNC receptacle
External addition input	
Addition gain	x0.4, x2, x10, or off (switchable) The maximum output range is fixed to 0.8 V <sub>p-p</sub> for x0.4, 4 V <sub>p-p</sub> for x2, and 20 V <sub>p-p</sub> for x10. Input voltage -1 V to +1 V
Maximum allowable input	±2 V
Input frequency	DC to 10 MHz (-3 dB)
Input impedance	10 kΩ, unbalanced
Input connector	Front panel (WF1983) / rear panel (WF1984), BNC receptacle Shared with external modulation input, and not available when external modulation.
Multi-I/O	
Usage	For sweep control, sequence control, each 4-bit general-purpose IO port (access is possible only from an external interface)
Input voltage	TTL level (low level 0.8 V or lower, high level 2.6 V or higher. 10 kΩ, pull up to +5 V)
Maximum allowable input	-0.5 V to +5.5 V
Output voltage	TTL level (low level 0.4 V or lower, high level 2.7 V or higher/open)
Connector	Rear panel, Mini-Dsub 15-pin multi connector

### 17.12.1 BNC Connector Placement

The placement locations differ for BNC connectors depending on the model. Also refer to the outline drawing.

BNC connector placement

Name	Placement location
FCTN OUT	Front panel
SUB/SYNC OUT	Front panel
TRIG IN	WF1983: Front panel WF1984: Rear Panel
MOD/ADD IN	WF1983: Front panel WF1984: Rear Panel
10MHz REF IN	Rear Panel
REF OUT	Rear Panel

## 17.13 2 Channel Coordination Operation (WF1984 Only)

Channel mode

Channel mode	Operation:
Independent	Independent setting
2 phases	Oscillation in the same frequency. Limited to be the same for the oscillation mode, modulation type, and sweep type. Noise and DC cannot be selected. External FM and external FSK are not allowed. Burst and gated single sweep are not allowed.
Constant frequency difference	Oscillation with the frequency difference constant. Limited to be the same for the oscillation mode, modulation type, and sweep type. Noise and DC are not allowed. External FM and external FSK are not allowed. Burst and gated single sweep are not allowed.
Constant frequency ratio	Oscillation with the frequency ratio constant. Limited to be the same for the oscillation mode, modulation type, and sweep type. Noise and DC are not allowed. External FM and external FSK are not allowed. Burst and gated single sweep are not allowed.
Differential output	Oscillation with the same frequency and amplitude reverse phase waveform. DC offset changes to the same polarity. Limited to be the same for the oscillation mode, modulation type, and sweep type. Noise and DC are not allowed. External modulation is not allowed. External addition is not allowed. Burst and gated single sweep are not allowed.
Differential output 2	Same as differential output but DC is reversed polarity. When the hot sides of CH1 and CH2 are used as the output, including DC, it is possible to obtain the double amount of output voltage (however, the output impedance is 100 Ω).

Equivalence setting and equivalence operation Yes

Frequency difference setting range 0.00 μHz to less than 60 MHz  
Resolution: 0.01 μHz (<50 MHz), 0.1 μHz (50 MHz≤)  
CH2 frequency - CH1 frequency

Frequency ratio N:M setting range 1 to 9 999 999 (for both N and M)  
N:M = CH2 frequency:CH1 frequency

Phase synchronization operation Auto executed when the channel mode is changed

Time difference between channels for 2-phase\*1±20 ns or less (±10 ns or less typ.)  
Conditions: continuous oscillation, same waveform (sine wave or square wave), load 50 Ω, DC offset setting 0 V, amplitude setting 10 Vp-p/50 Ω

## 17.14 Synchronization of Multiple Units

Connection

Connect the frequency reference output of the master unit to the frequency reference input of the slave unit  
Connect the frequency reference output of the slave unit to the frequency reference input of the other slave unit

Connection method 1

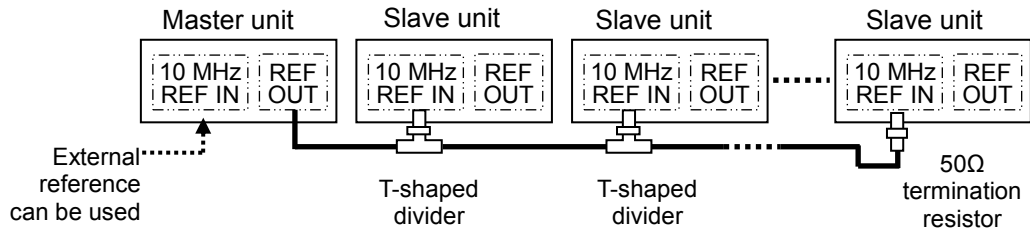

Connection method 2

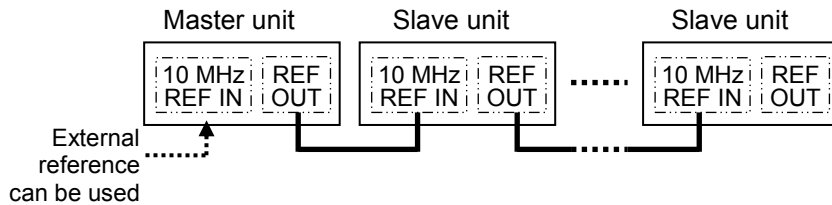

Connection cables

Cable type

Characteristic impedance 50  $\Omega$  series coaxial cable with BNC connector (RG-58A/U etc.)

Limitation on cable length

1 m or less between units, total cable length of 3 m or less

Maximum number of units for connection

Connection method 1: 6 units including master unit  
Connection method 2: 4 units including master unit

Phase synchronization operation

Manual operation

Time difference between waveform output units

Delay of each channel of Nth slave unit with respect to each channel of master unit ( $1 \leq N$ )

Connection method 1:  $25 \text{ ns} + (N-1) \times 6 \text{ ns} \pm 25 \text{ ns}$  or less typ.

Connection method 2:  $25 \text{ ns} + (N-1) \times 25 \text{ ns} \pm 25 \text{ ns}$  or less typ.

Conditions: Same frequency, same phase, same waveform (sine wave or square wave), and length of connection cable between frequency reference output and external frequency reference input = 1 m (RG-58A/U)

## 17.15 User-defined Units

Function

Set and display settings in any unit based on a specified conversion expression

Setting items

Frequency (Hz), cycle (sec), amplitude ( $V_{p-p}$ ,  $V_{pk}$ ), DC offset (V), phase (deg) and duty (%)

Conversion expression

$[(\text{setting target value})+n] \times m$  or  $[\log_{10}(\text{setting target value})+n] \times m$

Unit string

Specify a conversion expression and values of n and m.  
Maximum 4 characters

## 17.16 Setting Value Upper and Lower Limit Function

Function

Limit the upper and lower limits of setting values. However, this is not applied to external addition.

Setting target

Frequency, negative and positive values of output voltage (amplitude setting  $[V_{p-p}] \div 2 + \text{DC offset setting [V]}$ ), phase,

Setting range and resolution  
duty  
In accordance with the setting range of each target

## 17.17 Other Functions

Setting saving memory  
10 sets (saved to non-volatile memory)  
Saving to USB flash memory is possible.

## 17.18 External Storage

Media  
USB flash memory  
Connector  
Front panel, USB-A connector, USB 2.0 Hi-speed  
File format  
FAT  
Stored data  
Setting conditions, arbitrary waveform data, sequence data, and screen images  
Screen image save function  
File format  
Microsoft Windows bitmap file (extension: .BMP, image size: 640x272)  
File size  
Approx. 256 KiB  
File name  
screenshotX.bmp (X: Number, which is automatically incremented)  
File save location  
Root folder

## 17.19 Remote Interfaces

- GPIB  
Standard  
IEEE-488.1, IEEE-488.2  
Connector  
Rear panel, GPIB connector  
Interface function  
SH1, AH1, T6, L4, SR1, RL1, PP0, DC1, DT1, and C0
- USB  
Standard  
USB 1.1 Full Speed  
Connector  
Rear panel, USB-B connector  
Device class TMC (Test and Measurement Class)
- LAN  
Standard  
10/100Base-T  
Connector  
Rear panel, RJ-45 connector  
Protocol  
TCP/IP (socket communication)

## 17.20 Options

PA-001-1318 Multi-I/O Cable  
Cable with connector on one end, for connection to multi-I/O connector on rear panel. 2 m length. Cut off at one end.  
PA-001-3838 Rack Mount Kit (EIA, for 1 unit)  
PA-001-3839 Rack Mount Kit (EIA, for 2 units)  
PA-001-3840 Rack Mount Kit (JIS, for 1 unit)  
PA-001-3841 Rack Mount Kit (JIS, for 2 units)

## 17.21 General Characteristics

Display  
4.3 inch TFT color LCD  
I/O ground  
Signal grounds for waveform output (FCTN OUT), synchronization/sub-output (SYNC/SUB OUT), external modulation/addition input (MOD/ADD IN) are insulated from the enclosure.  
These signal grounds are shared within the same channel.  
The signal ground for the external 10MHz frequency reference input (10MHz REF IN) is insulated from the enclosure.  
Each of the signal grounds of CH1, CH2, and 10 MHz reference input are independent.  
The maximum withstand voltage is 42 Vpk (DC+AC peak) between insulated signal grounds and enclosures.  
Other signal grounds are connected to enclosures.

Power supply  
 Power voltage range 100V to 240V AC  
 Power frequency range 50 Hz/60 Hz  $\pm 2$  Hz  
 Power consumption WF1983: 50 VA or less  
 WF1984: 75 VA or less  
 Overvoltage category II

Ambient temperature/humidity range conditions

Guaranteed operation range 0°C to +40°C, 5%RH to 85%RH  
 (Where absolute humidity is 1 g/m<sup>3</sup> to 25 g/m<sup>3</sup>, non-condensing)  
 The temperature range is limited for some specifications  
 Altitude: 2 000 m or lower

Storage requirements: -10°C to +50°C, 5%RH to 95%RH (Where absolute humidity is 1 g/m<sup>3</sup> to 29 g/m<sup>3</sup>, non-condensing)

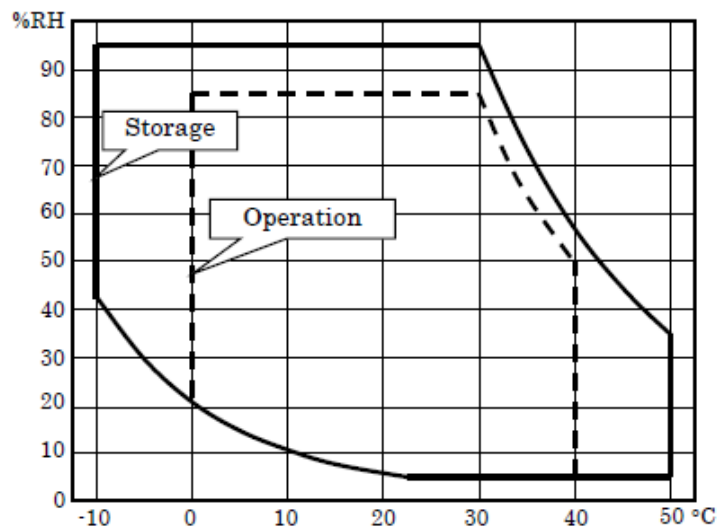

Pollution degree 2  
 Installation location Indoor use  
 Warm-up time 30 minutes or more  
 Outline dimension 215 (W) x 88 (H) x 306 (D) mm (excluding protrusions)  
 Weight Approx. 1.8 kg (main body excluding accessories)  
 Safety, EMC, and RoHS  
 Safety EN 61010-1  
 EMC EN 61326-1 (Group 1, Class A)  
 Applicable to only models with the CE marking on the rear panel.  
 RoHS Directive 2011/65/EU



■ Outline dimensional drawing (WF1983)

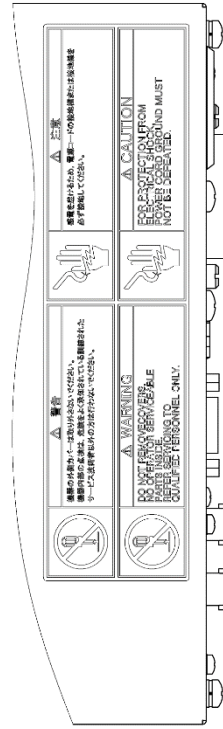
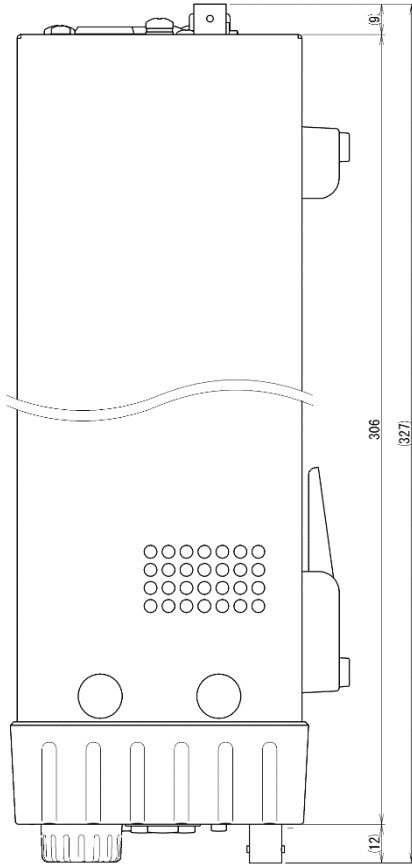

Arrow view A

- Surface treatment : Plastic sheet Ultra light gray (Munsell 6PB9.2/0.1)
- Front panel : Plastic sheet Light gray (Munsell 6PB7.6/1.2)
- Rear panel : Painting Light gray (Munsell 6PB7.6/1.2)
- Cover

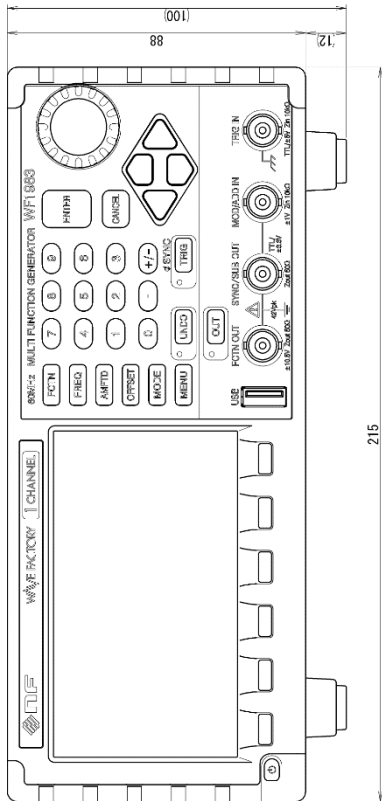

Arrow view A

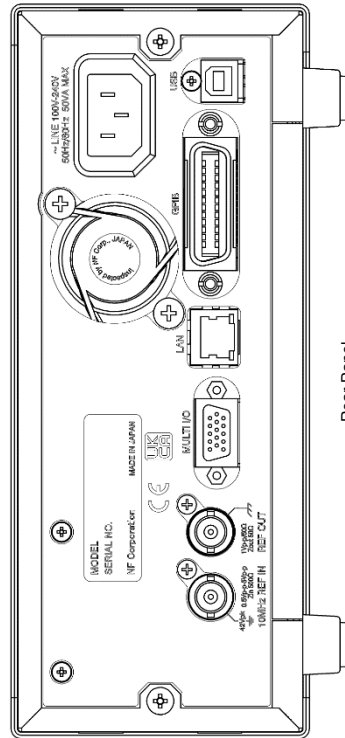

Rear Panel

■ Outline dimensional drawing (WF1984)

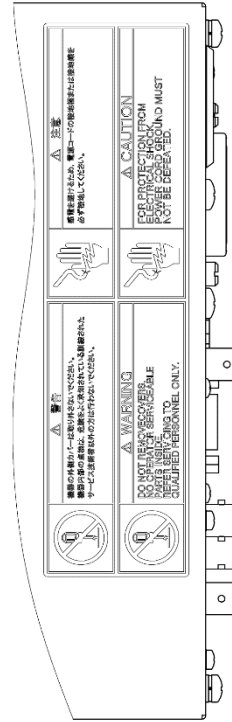
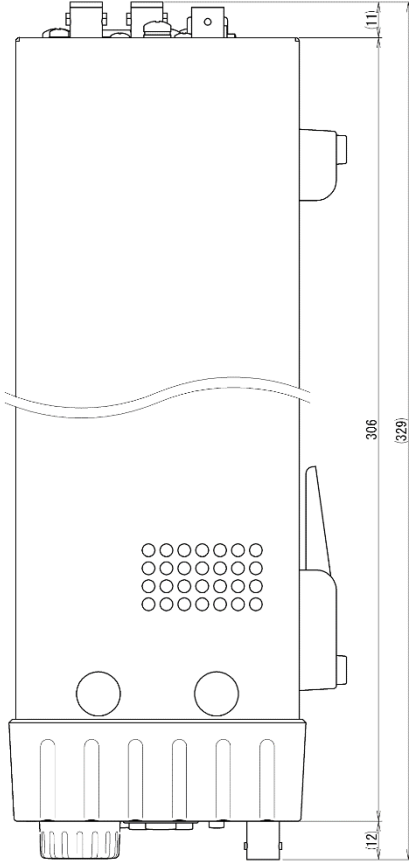

ATOW view A

- Surface treatment : Plastic sheet Ultra light gray (Munsell 6PB9.2/0.1)
- Front panel : Plastic sheet Light gray (Munsell 6PB7.6/1.2)
- Cover : Painting Light gray (Munsell 6PB7.6/1.2)

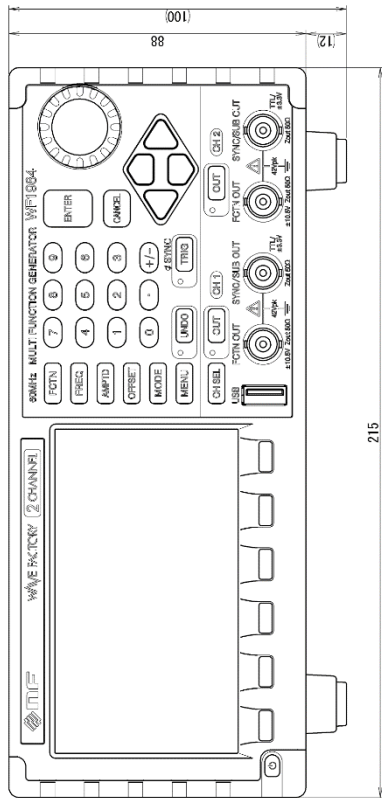

A

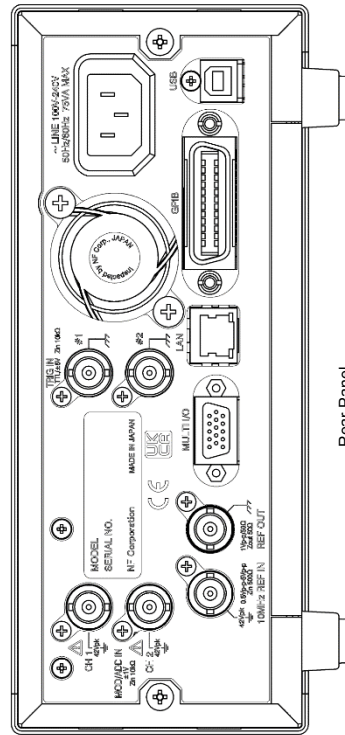

Rear Panel

■ Rack mount dimensional drawing (EIA, for 1 unit)

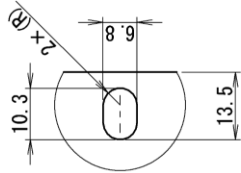
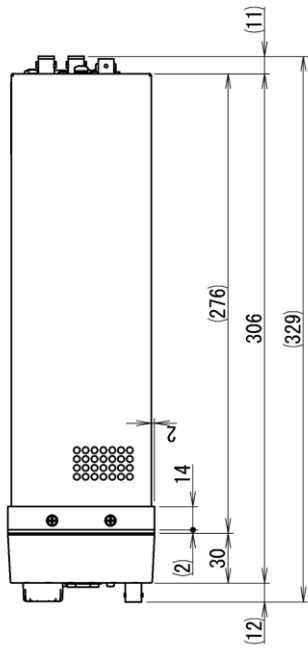

Part A details (1:1)

Surface treatment  
Ultra light gray (Munsell 6PB9,2/0.1)

The product outline drawings show a typical example of a product compatible with this rack mount kit.

Caution

When mounting the unit in the rack, do not hold it only with the rack-mount adapters.

Be sure to hold the main unit with brackets or shelves on the rack side.

When storing the unit on a shelf, take care that it does not interfere with the connecting brackets.

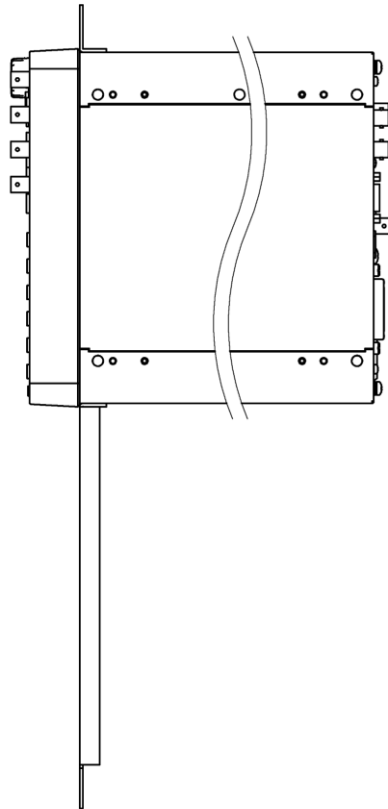
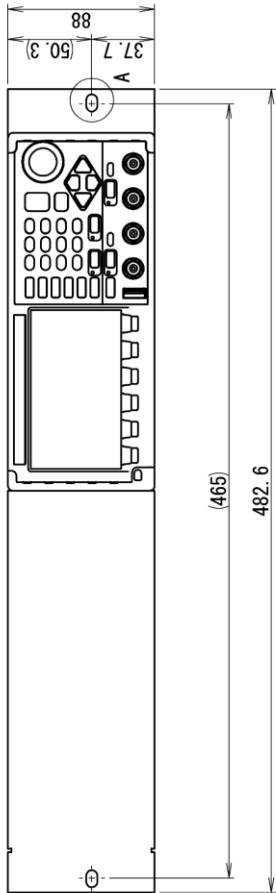

■ Rack mount dimensional drawing (EIA, for 2 units)

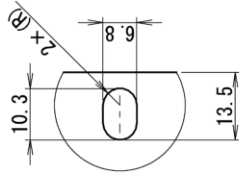
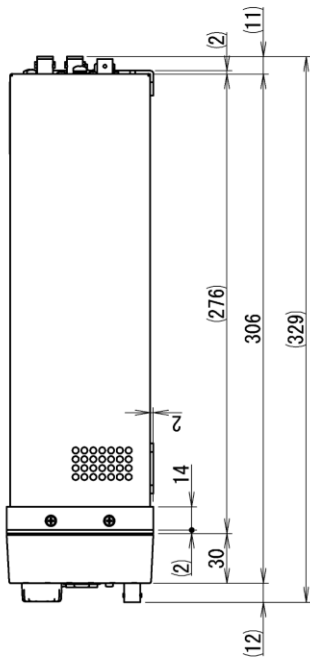

Part A details (1:1)

- Rack mount surface treatment
- Ultra light gray (Munsell 6PB9.2/0.1)
- Connecting bracket surface treatment
- Light gray (Munsell 6PB7.6/1.2)

The product outline drawings show a typical example of a product compatible with this rack mount kit.

**Caution**

When mounting the unit in the rack, do not hold it only with the rack-mount adapters. Be sure to hold the main unit with brackets or shelves on the rack side. When storing the unit on a shelf, take care that it does not interfere with the connecting brackets.

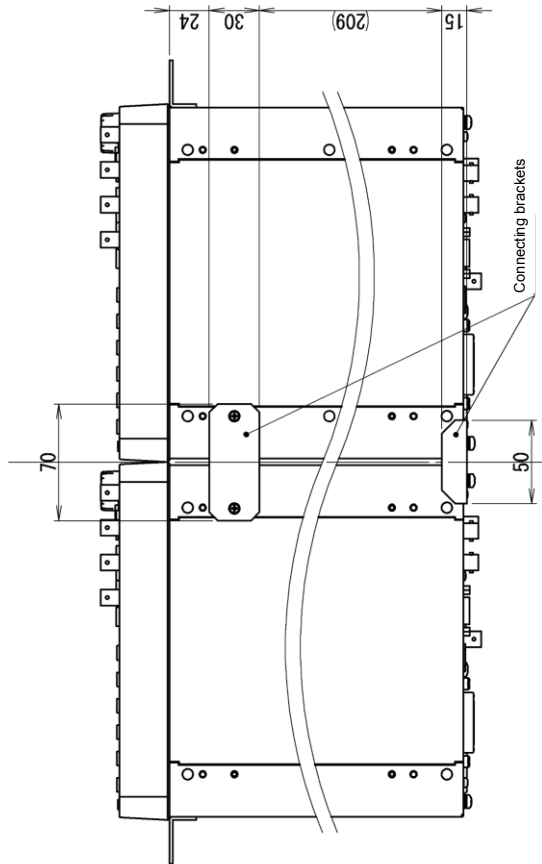
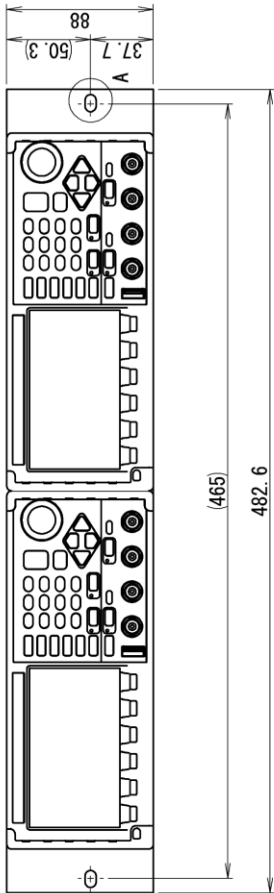

■ Rack mount dimensional drawing (JIS, for 1 unit)

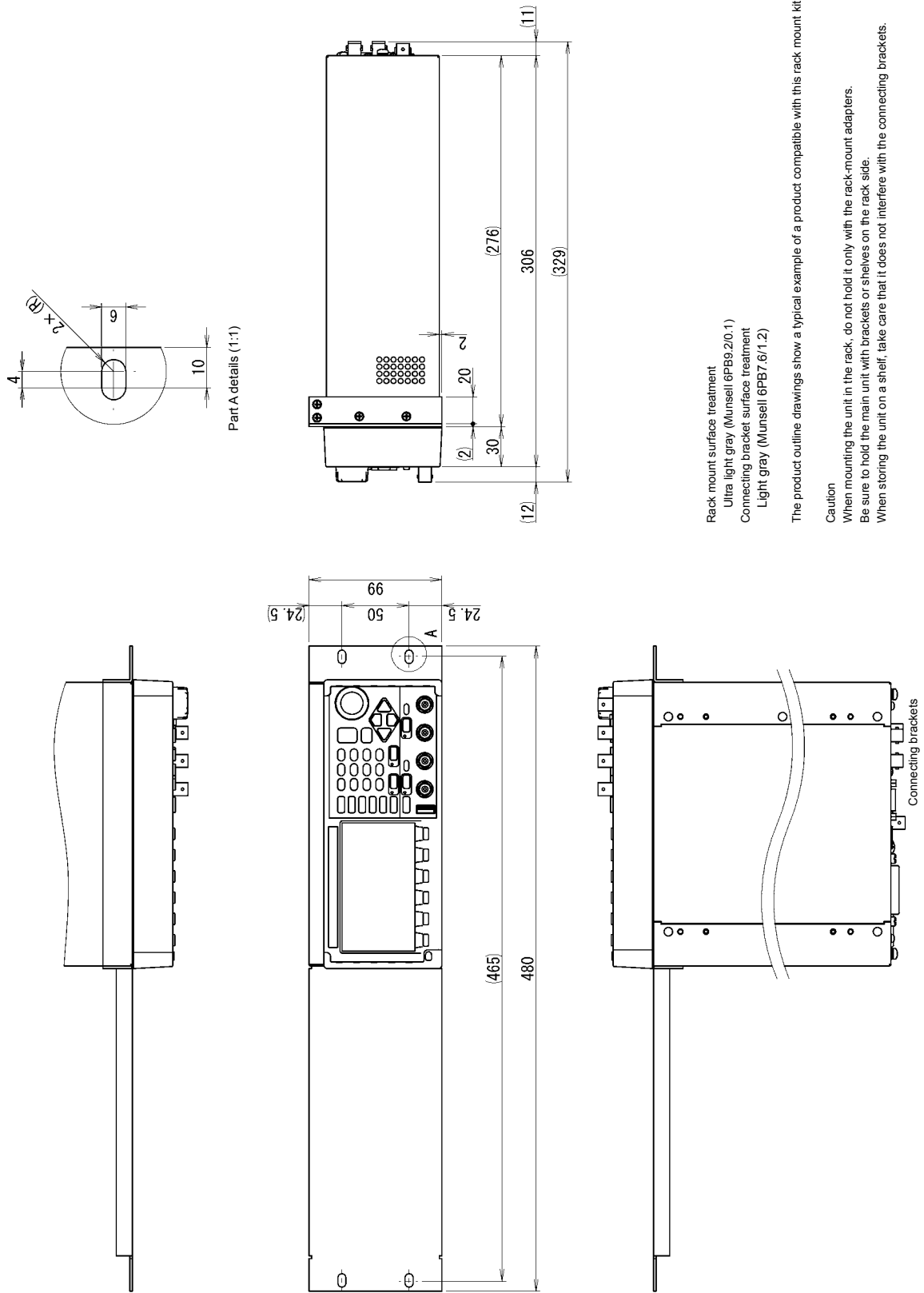

■ Rack mount dimensional drawing (JIS, for 2 unit)

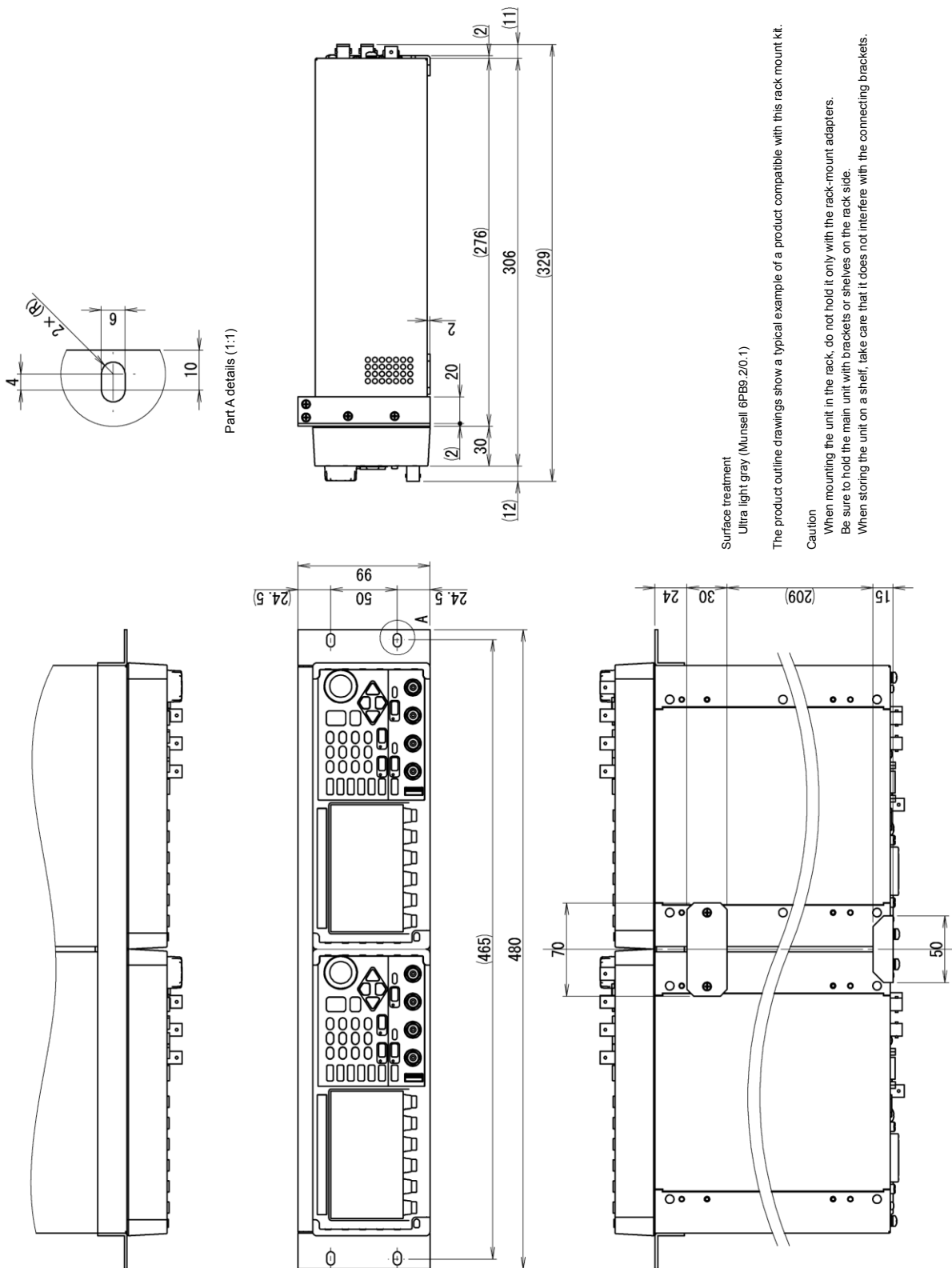

# WARRANTY

NF CORPORATION certifies that this product was thoroughly tested and inspected and found to meet its published specifications when it was shipped from our factory.

All NF products are warranted against defects in materials and workmanship for a period of three years from the date of shipment. During the warranty period, NF will repair the defective product without any charge for the parts and labor, or either repair or replace products which prove to be defective. For repair service under warranty, the product must be returned to either NF or an agent designated by NF. Purchaser shall prepay all shipping cost, duties, and taxes for the product to NF from another country, and NF shall pay shipping charge to return the product to purchaser.

This warranty shall not apply to any defect, failure or damage caused by improper use, improper or inadequate maintenance and care or modified by purchaser or personnel other than NF corporation.

**NF Corporation**

## REPAIR

When a failure occurred and the product was found to be defective or you have any uncertainty, please get in touch with NF Corporation or one of our representatives.

In such a case, let us know the model name (or product name), serial number (SERIAL No. given on the nameplate), and symptom and operating conditions as detail as possible.

Though we will make efforts to reduce the repair period, when five or more years have passed since you purchased the product, it may take time due to, for instance, the out of stock of repair parts.

Also, if the production of repair parts is discontinued, the product is extremely damaged, or the product is modified, we may decline the repair.

If there are any misplaced or missing pages, we will replace the manual. Contact the sales representative.

---

## NOTES

---

- Reproduction of the contents of this manual is forbidden by applicable laws.
- The contents of this manual may be revised without notice.
- Information provided in this manual is intended to be accurate and reliable.

However, we assume no responsibility for any damage regarding the contents of this manual.

- We assume no responsibility for influences resulting from the operations in this manual.

---

## WF1983/WF1984 Instruction Manual (Operation)

### **NF Corporation**

6-3-20 Tsunashima Higashi, Kohoku-ku, Yokohama 223-8508, JAPAN

Phone: +81-45-545-8128 Fax: +81-45-545-8187

<https://www.nfcorp.co.jp/>

© Copyright 2023 **NF Corporation**



