

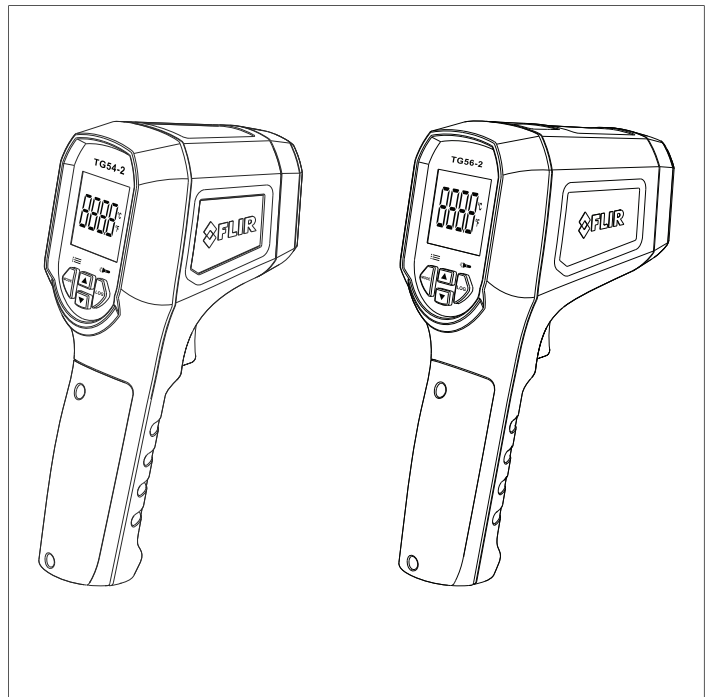

USER MANUAL

Spot IR Thermometer

Models TG54-2 and TG56-2





USER MANUAL

Spot IR Thermometer

Table of contents

1	Advisories	1
	1.1 Copyright.....	1
	1.2 Quality Assurance	1
	1.3 Documentation	1
	1.4 Disposal of Electronic Waste.....	1
2	Introduction	2
	2.1 Product Overview	2
	2.2 Product Features.....	2
3	Safety	3
4	Quick Start	4
5	Product Description	6
	5.1 Meter Description	6
	5.2 Control Buttons	7
	5.3 Display Icons	8
6	Powering the Meter	9
7	Measurements	10
	7.1 SCAN Mode.....	10
	7.2 HOLD Mode.....	10
	7.3 Auto-Scan Lock Mode	11
	7.4 MAX, MIN, AVG, and DIF Readings	11
	7.5 Distance to Spot (D:S) Ratio	12
	7.6 Emissivity Settings.....	12
	7.7 Thermocouple (Type K) Contact Measurements	14
	7.7.1 Using a Thermocouple to Find Optimal Emissivity Settings	15
8	High and Low Alarms	16
9	Programming Menu	17
	9.1 Programming Menu Overview	17
	9.2 Accessing the Programming Menu	17
	9.3 Setting High and Low Alarms	17
	9.4 Setting the Emissivity	18
	9.5 Setting the Temperature Units	18
	9.6 Setting the Auto-Scan Lock mode	19
	9.7 Setting the Laser Pointer ON-OFF.....	20
	9.8 Setting the Date and Time	20
	9.9 Setting the Auto Interval (Data Logger).....	21

Table of contents

9.10	Setting Auto Power OFF (APO).....	23
9.11	Viewing the Calibration (CAL) Date.....	23
9.12	Programming Menu at a Glance.....	24
10	Data Logger.....	26
10.1	Manual Datalogger	26
10.2	Automatic Data Logger (Auto Interval).....	26
10.3	Recalling and Deleting Logged Readings.....	28
11	Maintenance.....	29
11.1	Battery Replacement and Storage.....	29
11.2	Cleaning.....	29
12	Specifications.....	30
12.1	General Specifications.....	30
12.2	IR Thermometer Specifications.....	31
12.3	Laser Specifications.....	31
12.4	Thermocouple Specifications (TG56-2).....	31
13	Customer Support.....	32
14	Limited 3-Year Warranty.....	33

1 Advisories

1.1 Copyright

©2023 FLIR Systems, Inc. All rights reserved worldwide.

No parts of the software including source code may be reproduced, transmitted, transcribed or translated into any language or computer language in any form or by any means, electronic, magnetic, optical, manual or otherwise, without the prior written permission of FLIR.

The documentation must not, in whole or part, be copied, photocopied, reproduced, translated or transmitted to any electronic medium or machine-readable form without prior consent, in writing, from FLIR Systems, Inc. Names and marks appearing on the products herein are either registered trademarks or trademarks of FLIR Systems, Inc. and/or its subsidiaries. All other trademarks, trade names or company names referenced herein are used for identification only and are the property of their respective owners.

1.2 Quality Assurance

The Quality Management System under which these products are developed and manufactured has been certified in accordance with the ISO 9001 standard. FLIR Systems, Inc. is committed to a policy of continuous development; therefore, we reserve the right to make changes and improvements on any of the products without prior notice.

1.3 Documentation

To access the latest manuals and notifications, go to the Download tab at: <https://support.flir.com>. It only takes a few minutes to register online. In the download area you will also find the latest releases of manuals for our other products, as well as manuals for our historical and obsolete products.

1.4 Disposal of Electronic Waste



As with most electronic products, this equipment must be disposed of in an environmentally friendly way, and in accordance with existing regulations for electronic waste. Please contact your FLIR representative for more details.

2 Introduction

2.1 Product Overview

The FLIR TG Series IR Spot Thermometers quickly and safely capture non-contact surface temperature measurements. The high distance-to-spot ratio makes it possible to measure relatively small targets from a distance, in areas difficult or unsafe to reach.

The TG56–2 includes a Type K thermocouple input for contact temperature measurements. Comparing contact measurements with non-contact measurements allows for precise emissivity settings.

The vivid color display makes it easy to view readings, function icons, and menus. The bright worklight and laser pointer allow for precise targeting and working in dimly lit areas.

The TG Series can log up to 99 readings manually and 99 readings automatically. The high/low alarm triggers when temperature measurements exceed programmed limits.

Please visit our support site to check for the latest version of this manual and for customer support.









Support site: <https://flir.support.com>

2.2 Product Features

- IR sensor offers high accuracy non-contact surface temperature measurements
- Portable, rugged, and compact design
- Sharp, color graphical display
- Distance to spot ratio of 20:1 (TG54–2) and 30:1 (TG56–2)
- Type K thermocouple input (TG56–2)
- Manual and automatic data logging
- Maximum, Minimum, Average, and Differential memories
- Laser pointer for easy targeting
- Bright LED worklights
- High and low alarms with 5 alarm limit presets
- Programmable emissivity with 5 presets
- Tripod mount

3 Safety

Please read and understand all safety information before use.

	CAUTION				
Use caution when the Class 2 Laser pointer is on. Do not point the beam toward anyone's eye or allow the beam to strike the eye from a reflective surface.					
<table border="1"><tr><td></td><td>LASER 2</td><td></td><td>$\lambda=630\text{nm}-670\text{nm}, <1\text{mW}$ IEC 60825-1:2014 EN 50689:2021 MADE IN CHINA</td></tr></table> <p>Consumer laser product Complies with 21 CFR 1040.10 and 1040.11 except for conformance with IEC 60825-1 Ed. 3., as described in Laser Notice No. 56, dated May 8, 2019.</p>			LASER 2		$\lambda=630\text{nm}-670\text{nm}, <1\text{mW}$ IEC 60825-1:2014 EN 50689:2021 MADE IN CHINA
	LASER 2		$\lambda=630\text{nm}-670\text{nm}, <1\text{mW}$ IEC 60825-1:2014 EN 50689:2021 MADE IN CHINA		
	WARNING				
For the TG56-2, do not use the Type K thermocouple to measure surface temperatures that exceed 500°F (260°C); damage to the thermocouple and meter will result.					

4 Quick Start

1. Point the camera at a surface to test.
2. Pull and hold the trigger to scan surfaces. **SCAN** will flash on the display and the reading, shown at center, will track temperature changes in real time.

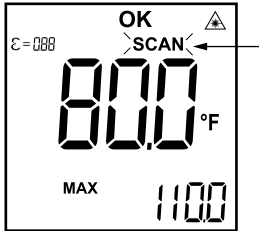

Figure 4.1 SCAN mode display.

3. The reading on the display, when you release the trigger, will be held for 5 or 15 seconds (as set in the programming menu, see Section 9) and the meter will then switch off. **HOLD** will show on the display while the reading is held.

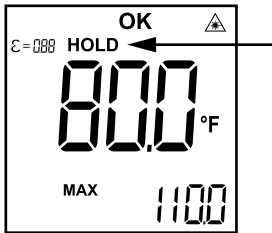

Figure 4.2 HOLD mode display.

4. If the measurement does not exceed an alarm limit, the display will show **OK**, otherwise **HI** or **LO** will flash on the display, indicating that a high or low alarm has been triggered (Section 8).
5. Actions that can be performed in the SCAN and HOLD modes are listed in Table 4.1, below.

Table 4.1 Actions that can be performed from the SCAN and HOLD modes.

ACTION	SCAN MODE	HOLD MODE
Short press LOG to store the current reading (Section 10).	YES	YES
Short press MODE to step through the MAX, MIN, AVG, DIF readings (Section 7.4). When a thermocouple is connected, the MAX, MIN, AVG, and DIF readings are not available.	YES	YES
Long press LOG to switch the worklights on or off.	YES	YES
Long press MODE to access the programming menu (Section 9).	NO	YES
Short press an arrow button to view manually logged readings. Use the arrows to then scroll through logged readings. To view readings stored using the Auto Interval mode, refer to Section 10.	NO	YES

5 Product Description

5.1 Meter Description

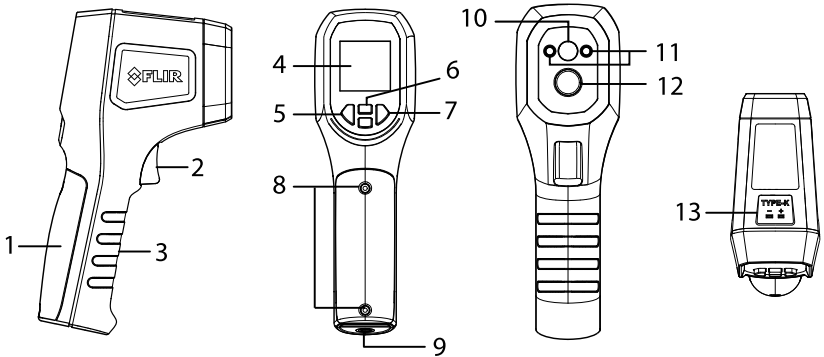

Figure 5.1 Meter Description

1. Battery compartment
2. Measurement trigger
3. Handle grip
4. Display
5. MODE / Menu button
6. Up/Down arrow buttons
7. LOG / Worklight button
8. Battery compartment screws
9. Tripod mount
10. Laser pointer lens
11. LED worklights
12. IR sensor lens
13. Thermocouple input (TG56-2)

5.2 Control Buttons



Figure 5.2 Control Buttons

The control buttons are only active when the display is switched on. Pull and release the trigger to switch on the display.

Table 5.1, below, lists the buttons in the left column, the action for each button in the centre column, and the mode where the action is possible in the right-most column.

Table 5.1 Control button actions.









BUTTON	ACTION	MODE
	Short press to step through the MAX, MIN, AVG, DIF memories (Section 7.4).	SCAN and HOLD
	Long press to open the programming menu (Section 9). When in the programming menu, short press to step through the menu options.	HOLD
	Press an arrow button to access the data log recall mode. In the recall mode, use the arrows to scroll through logged readings. There are 99 memory locations (Section 10).	HOLD
	In the programming menu, use the arrows to change settings (Section 9).	MENU

Table 5.1 Control button actions. (continued)

 	Short press to save the displayed reading; the display will flash twice to confirm.	SCAN and HOLD
	From the programming menu (Section 9), short press to scroll through the five presets (P1...P5). Each preset has a unique high and low alarm set point and emissivity setting.	MENU
	Short press to move from field to field within a programming menu.	MENU
	When in the data log mode, press to switch from manual to automatic logging mode (<i>Auto Interval</i> will show on the lower left corner). See Section 10 for data logging specifics.	LOG

5.3 Display Icons

	Auto-Scan Lock (hands-free scan)	LOG 888	Data log reading number
	Worklights	2088-88-88	Date (YYYY : MM : DD)
HI OK LO	High/Low Alarms (OK = no alarm)	88:88 AM	Time (HH : MM)
	Laser pointer	MAX	Maximum reading shown on secondary display
$\epsilon = 888$	Emissivity setting	MIN	Minimum reading shown on secondary display
HOLD	Reading is held	AVG	Average reading shown on secondary display
SCAN	Flashes when readings are taken	DIF	Differential reading shown on secondary display
	Flashing low battery icon	Auto Interval	Automatic data logging
8888 °C 8888 °F	Primary display digits	88:88	Secondary display digits
	Icon appears when thermocouple is connected (TG56-2)		

6 Powering the Meter

The meter is powered by one 9 V battery. The battery compartment is located in the meter handle, secured by two screws (see Section 5, *Product Description*).

To replace the battery, refer to Section 11. To switch the meter on, pull and release the trigger. If the display does not switch on, or if the low battery icon is flashing, replace the battery.

7 Measurements

7.1 SCAN Mode

To perform a scan, pull and hold the trigger and target several surfaces in succession using the laser pointer. Notice that the reading (centre of display) responds immediately to the temperature variations. **SCAN** will flash on the display while scanning. See image below.

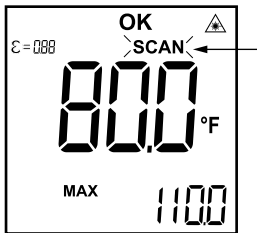

Figure 7.1 SCAN mode display.

For the best accuracy, determine the size of the targeted spot, based on your distance from the target. Refer to Section 7.5, below, for instructions regarding the distance to spot ratio (D:S).

For hands-free scanning (Auto-Scan Lock), see Section 7.3, below.

7.2 HOLD Mode

When you release the trigger, **HOLD** will appear and the last reading will remain on the display for the selected APO time (5 or 15 seconds), as selected in the programming menu (Section 9). See image below.

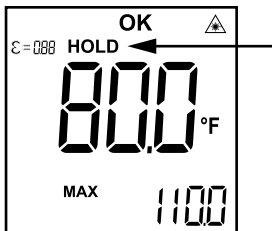

Figure 7.2 HOLD mode display.

7.3 Auto-Scan Lock Mode

The auto-scan lock allows for hands-free scanning over a programmable time period.

Enable the auto-scan lock, and set its timer, in the programming menu (Section 9). You can set the timer from 1 minute to 4 hours and 59 minutes.

After enabling the auto-scan lock and setting its timer, hands-free scanning will begin the next time you pull and release the trigger.

The meter will remain in the Scan mode for the length of time you've specified, after which it will automatically switch to the HOLD mode and power down.

The Lock icon will appear on the upper left corner of the display as shown in Figure 7.3, below, while scanning.

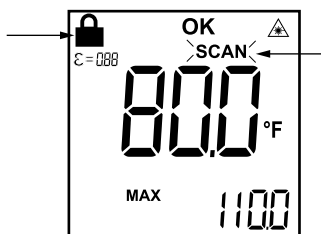

Figure 7.3 Auto Scan Lock screen showing the LOCK symbol and the flashing SCAN icon.

To end an auto-scan session before the lock timer elapses, pull and release the trigger.

NOTE

It is possible to set the auto-scan lock timer to 00:00. Doing so allows the meter to continue testing indefinitely, until the batteries drain.

7.4 MAX, MIN, AVG, and DIF Readings

Each time the trigger is pulled and held (SCAN mode), the Maximum (MAX), Minimum (MIN), Average (AVG), and Differential (DIF) readings are tracked.

Short press the MODE button to select one of the four modes to monitor while scanning. The selected reading is shown on the smaller, secondary display digits, on the lower right of the display. This reading updates in real time as you scan.

In the HOLD mode you can scroll these reading memories for the previous scanning session by pressing MODE. Each memory is cleared when the trigger is pulled. Each mode is described below.

- **MIN/MAX readings.** The lowest and highest measurements.
- **AVG reading.** The average reading (the meter averages 20 readings).
- **DIF reading.** The MAX minus the MIN temperature.

When a thermocouple is connected, the MAX, MIN, AVG, and DIF readings are not available.

7.5 Distance to Spot (D:S) Ratio

The TG series offers 20:1 (TG54–2) and 30:1 (TG56–2) D:S ratios. The D:S ratio allows you to calculate the size of the measurement spot based on the distance from the spot. Refer to the diagrams below.

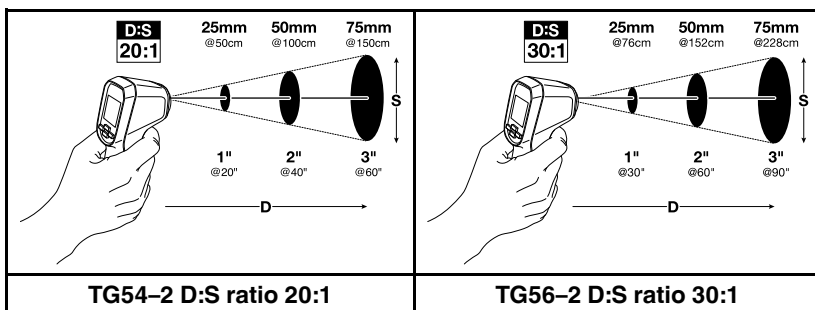

Figure 7.4 Distance (D) to Spot (S) Ratio.

7.6 Emissivity Settings

The amount of IR energy emitted by an object is proportional to the object's temperature and its ability to emit energy. This ability is known as emissivity.

Emissivity is adjustable in 0.01 steps from 0.01 to 1.00; the default value is 0.95. Set the emissivity in the programming menu (Section 9). Up to 5 preset emissivity values can be set, allowing you to easily switch between commonly used settings.

Set the emissivity based on the material and finish of the object you are measuring. A flat black surface has an emissivity of 0.95. Preparing a surface with flat black paint or tape simplifies the emissivity setting process. Shiny and

reflective surfaces have a much lower emissivity. See Table 7.1, for a list of common materials and their approximate emissivity values.

For the TG56–2, you can optimize emissivity settings using a thermocouple (Section 7.7).

Table 7.1 Approximate Emissivity values for common materials (for reference only).

Material	Emissivity	Material	Emissivity
Asphalt	0.90 to 0.98	Cloth (black)	0.98
Concrete	0.94	Skin (human)	0.98
Cement	0.96	Leather	0.75 to 0.80
Sand	0.90	Charcoal (powder)	0.96
Soil	0.92 to 0.96	Lacquer	0.80 to 0.95
Water	0.92 to 0.96	Lacquer (matt)	0.97
Ice	0.96 to 0.98	Rubber (black)	0.94
Snow	0.83	Plastic	0.85 to 0.95
Glass	0.90 to 0.95	Timber	0.90
Ceramic	0.90 to 0.94	Paper	0.70 to 0.94
Marble	0.94	Chromium Oxides	0.81
Plaster	0.80 to 0.90	Copper Oxides	0.78
Mortar	0.89 to 0.91	Iron Oxides	0.78 to 0.82
Brick	0.93 to 0.96	Textiles	0.90

7.7 Thermocouple (Type K) Contact Measurements



WARNING

The supplied thermocouple must not be used to measure temperature above 500°F (260°C). If higher temperatures are to be measured, a thermocouple that is specified for the desired range must be used. Attempting to measure temperature higher than 500°F (260°C) with the supplied thermocouple will damage the probe and the meter.

The TG56–2 includes a thermocouple input socket, located at the top of the meter. The TG56–2 is configured to accept a Type K thermocouple.

To ensure proper polarity, the meter's sub-miniature input socket is keyed so that the thermocouple plug can only be inserted in one orientation. Ensure that the thermocouple connector is correctly oriented before applying pressure to insert it.

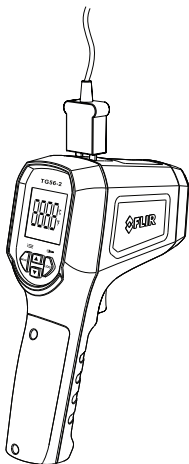



Figure 7.5 TG56–2 with thermocouple connected.

When a thermocouple is connected, the meter displays a thermocouple symbol .

Hold the measurement tip of the thermocouple to the surface under test and read the measurement at the bottom right of the meter's display, in small digits. The IR temperature is shown at the centre of the display in large digits. See example screen below.

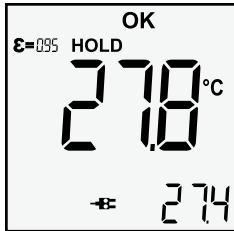

Figure 7.6 Thermocouple reading display.

When a thermocouple is connected, the MAX, MIN, AVG, and DIF readings are not available.

7.7.1 Using a Thermocouple to Find Optimal Emissivity Settings

The thermocouple is useful in finding the correct emissivity for a surface. As described below, the emissivity setting is correct if contact and non-contact temperature measurements, of the same spot, yield the same reading.

1. Perform a contact measurement (thermocouple) of a surface and note the reading.
2. Perform an IR non-contact measurement of the same surface and note the reading.
3. Adjust the emissivity and recheck the IR non-contact measurement.
4. Repeat steps 1, 2, and 3 until both measurements give the same temperature reading.
5. The emissivity will then be correctly set for the surface under test.

8 High and Low Alarms

The TG series features a high and low temperature alarm with five high/low set point presets, as explained below.

1. Press and release the trigger to enter the HOLD mode.
2. Long press the MODE button to access the programming menu (Section 9) and view the high alarm set point screen. **HI** will be shown on the display.
3. Use the LOG button to select a preset (P1...P5).
4. Use the arrow buttons to set the high alarm set point.
5. Press the MODE button to step to the low alarm limit screen. **LO** will be shown on the display. Use the arrow buttons to adjust the low alarm set point.
6. Pull and release the trigger to exit the programming menu.

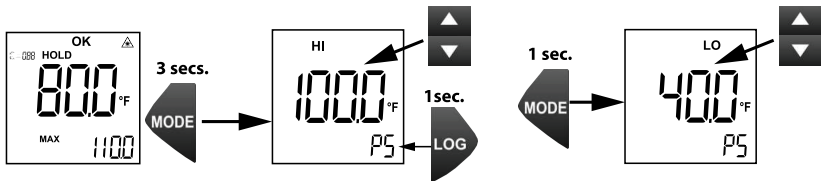

Figure 8.1 Setting the high and low alarm set points.

When a temperature measurement exceeds the high or low limit, the **HI** or **LO** icon flashes on the display, in the SCAN or HOLD modes. When measurements are within safe limits (not exceeding an alarm set point), the display shows **OK**.

You can set 5 pairs of high/low alarm set points, one pair for each preset (P1... P5). Step 3, in the procedure above, is where you select a preset.

9 Programming Menu

9.1 Programming Menu Overview

The program menu allows you to perform the following actions.

- Set high and low alarm set points
- Set emissivity
- Change temperature units
- Enable/disable the auto-scan lock and set its timer
- Enable/disable the laser pointer
- Select 12 or 24 hour clock, and set the date/time
- Configure the automatic data logger (Auto Interval)
- Set APO to 5 or 15 seconds
- View last calibration date

9.2 Accessing the Programming Menu

1. Pull and release the trigger to access the HOLD mode.
2. Long press the MODE button until the menu opens, the selected preset number will appear on the lower right (Px).
3. Short press the LOG button to select one of the five presets (P1...P5).
Each preset has a unique high/low alarm set point and emissivity setting.

9.3 Setting High and Low Alarms

The first parameter shown in the menu is the high (HI) alarm set point as shown in Figure 9.1, below. Use the arrow buttons to select a high alarm set point. Press the LOG button to select a preset (P1...P5); you can program 5 sets of high/low set points. Press the MODE button to move to the low alarm (LO) set point parameter. Use the arrow buttons to select the low alarm set point.

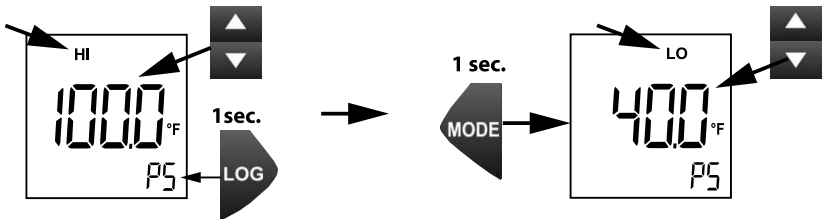

Figure 9.1 Setting the high and low alarm set points in the programming menu.

To save the settings and return to the normal operation mode, press and release the trigger. Otherwise press the MODE button to move to the Emissivity parameter.

9.4 Setting the Emissivity

If you are continuing from the previous menu, use the arrow buttons to set the emissivity value between 0.01 to 1.00 and use the LOG button to select a pre-set location (see Figure 9.2).

To access this setting with the meter off, pull and release the trigger to enter the HOLD mode, long press the MODE button to enter the program menu, and then press the MODE button **twice**. Now use the arrows to set the emissivity. See Section 7.6 for additional Emissivity information.

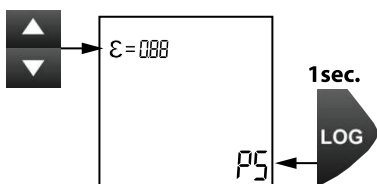

Figure 9.2 Setting the emissivity value and selecting a preset.

To save the setting and return to the normal operation mode, press and release the trigger. Otherwise press the MODE button to move to the temperature units parameter.

9.5 Setting the Temperature Units

If you are continuing from the previous menu, use the arrow buttons to select °C or °F.

To access this setting with the meter off, pull and release the trigger to enter the HOLD mode, long press the MODE button to enter the program menu, and then press the MODE button **three** times. Now use the arrows to select the unit of measure.

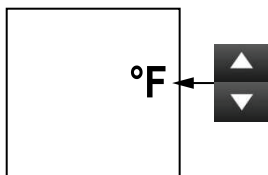

Figure 9.3 Setting the temperature units.

To save the setting and return to the normal operation mode, press and release the trigger. Otherwise press the MODE button to move to the Lock parameter.

9.6 Setting the Auto-Scan Lock mode

When the auto-scan lock mode (hands-free scanning) is active, you can pull and release the trigger and scan for a programmable time period without having to hold the trigger.

If you are continuing from the previous menu, use the arrow buttons to set the lock ON or OFF and then set the timer from 1 minute to 4 hours and 59 minutes. Use the LOG button to switch between the hours and minutes fields, and use the arrow buttons to set the timer. When the digits are flashing, they are ready to be changed.

When no digits are flashing, pull and release the trigger to start hands-free scanning. If you prefer to start the scanning at a later time, short press the MODE button to continue through the programming menu. At a later time you can pull and release the trigger to start hands-free scanning.

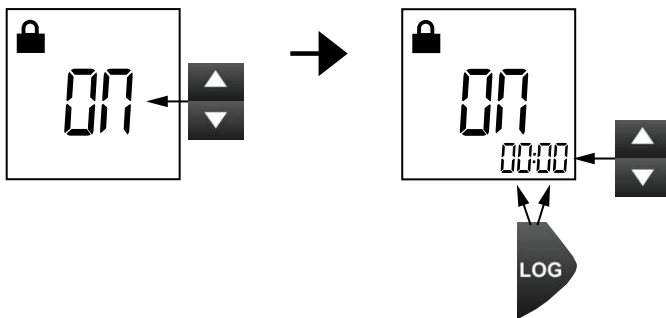

Figure 9.4 Setting Auto-Scan ON and setting the timer.

To access this setting with the meter off, pull and release the trigger to enter the HOLD mode, long press the MODE button to enter the program menu, and then press the MODE button **four** times.

9.7 Setting the Laser Pointer ON-OFF

If you are continuing from the previous menu, use the arrow buttons to set the Laser ON or OFF. If you select ON, the laser will switch on each time you pull the trigger. If you set it to OFF, the laser will be disabled.

To access this setting with the meter off, pull and release the trigger to enter the HOLD mode, long press the MODE button to enter the program menu, and then press the MODE button **five** times. Now use the arrows to set the laser ON or OFF.

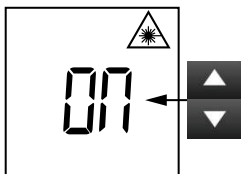

Figure 9.5 Enabling and disabling the laser pointer.

To save the setting and return to the normal operation mode, pull and release the trigger. Otherwise press the MODE button to move to the Date/Time parameter.

9.8 Setting the Date and Time

If you are continuing from the previous menu, use the arrow buttons to first select the 12 or 24 hour clock mode and then to set the calendar clock. Use the LOG button to move from field to field.

To access this setting with the meter off, pull and release the trigger to enter the HOLD mode, long press the MODE button to enter the program menu, and then press the MODE button **six** times. Now use the arrows to set the 12/24 clock mode, date, and time. Use the LOG button to move from field to field.

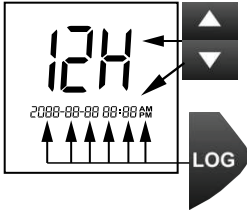

Figure 9.6 Select the 12/24 clock mode first, and then set the calendar clock (from left to right: year, month, date, hours, minutes, AM/PM).

To save the setting and return to the normal operation mode, press and release the trigger. Otherwise press the MODE button to move to the Auto Interval (data logger) parameter.

9.9 Setting the Auto Interval (Data Logger)

Important note: Before you begin configuring the data logger, set the meter’s time and date as explained in Section 9.8, otherwise the data logger will not operate as expected.



If you’re continuing from the previous menu, follow the steps in Table 9.1, below.

To access this setting with the meter off, pull and release the trigger to enter the HOLD mode, long press the MODE button to enter the program menu, and then press the MODE button **seven** times. Follow the steps in Table 9.1, below:

Table 9.1 Setting up the Auto Interval (automatic data logger) function.

	<p>Use the arrow buttons to set the mode ON (or OFF).</p>
	<p>Press the LOG button to move to the next screen.</p>

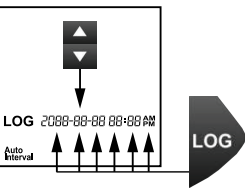
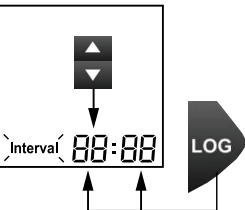
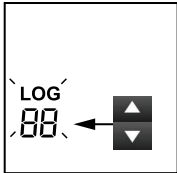
Table 9.1 Setting up the Auto Interval (automatic data logger) function. (continued)

	<p>Use the arrow buttons to set the exact date and time that automatic data logging will begin. Use the LOG button to step from field to field and then to the next step. Digits flash when they are ready to be edited.</p>
	<p>Use the arrow buttons to set the sampling rate (interval of time between readings) from 1 minute to 96 hours and 59 minutes (00:01 to 96:59). Use the LOG button to step from hours to minutes and then to the next step.</p>
	<p>Use the arrow buttons to select the number of readings to log (99 maximum).</p>
	<p>Press LOG to complete the setup.</p>

Press the MODE button to move to the next parameter (APO) or pull and release the trigger to exit the programming mode.

After configuring the Auto Interval (automatic data logger) function, as described above, the meter will perform the following actions automatically:

- The meter will start logging at the time and date that you have designated.
- Readings will be taken at the interval (rate) that you have specified.
- Data logging will stop when the number of readings that you have selected has been reached.

See Section 10 for details on recalling/deleting readings, and switching between manual and automatic memory banks.

9.10 Setting Auto Power OFF (APO)

If you are continuing from the previous menu, use the arrow buttons to set the APO to 5 or 15 seconds. This is the amount of time that the meter will HOLD a reading after the trigger is released, before switching off.

To access this setting with the meter off, pull and release the trigger to enter the HOLD mode, long press the MODE button to enter the program menu, and then press the MODE button **eight** times. Now use the arrows to set 5 or 15 seconds.

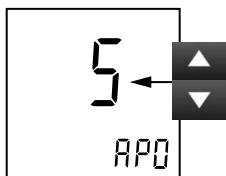

Figure 9.7 Setting the Auto Power OFF (APO) time.

To save the setting and return to the normal operation mode, pull and release the trigger. Otherwise press the MODE button to move to the calibration date parameter.

9.11 Viewing the Calibration (CAL) Date

If you are continuing from the previous menu, simply view the date of the most recent calibration and then press MODE to return to the normal operation mode.

To access this setting with the meter off, pull and release the trigger to enter the HOLD mode, long press the MODE button to enter the program menu, and then press the MODE button **nine** times. View the date of the most recent calibration and then press MODE to exit the programming menu.

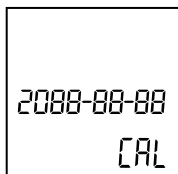

Figure 9.8 View the date of the latest calibration.

9.12 Programming Menu at a Glance

After reading the in-depth programming menu information above, use Table 9.2, below, as a shortcut to quickly program the meter.

The Setting column lists the desired actions, the Instruction column lists the steps required, and the Quick Navigation column lists the number of MODE button presses it requires to move quickly from the first menu screen to the desired setting.

Table 9.2 Programming menu at a glance.

SETTING	INSTRUCTIONS	QUICK NAVIGATION
High Alarm Set Point	<p>Long press MODE (from the HOLD mode) to access this screen.</p> <p>Use the arrows to change the set point.</p> <p>Press LOG to choose a preset.</p> <p>Press MODE to step to the next parameter.</p>	First screen in menu.
Low Alarm Set Point	<p>Use the arrows to change the set point.</p> <p>Press MODE to step to the next parameter.</p>	Press MODE once from first screen.
Emissivity	<p>Use the arrows to set the emissivity.</p> <p>Press LOG to choose a preset.</p> <p>Press MODE to step to the next parameter.</p>	Press MODE 2 times from first screen.
Temperature Units	<p>Use the arrow buttons to change the units.</p> <p>Press MODE to step to the next parameter.</p>	Press MODE 3 times from first screen.
Auto-Scan Lock	<p>Use the arrows to set the Auto-Scan Lock ON or OFF.</p> <p>Use the LOG button to select the timer's Minutes and Hours fields and use the arrows to change the time.</p> <p>Press MODE to step to the next parameter.</p>	Press MODE 4 times from first screen.
Laser Pointer	<p>Use the arrows to enable or disable the laser.</p> <p>Press MODE to step to the next parameter.</p>	Press MODE 5 times from first screen.

Table 9.2 Programming menu at a glance. (continued)

Calendar Clock	Use the arrows to select 12 or 24 clock mode. Use the LOG button to step through the year, month, day, hours, minutes and AM/PM fields and use the arrow buttons to change a setting. Press MODE to step to the next parameter.	Press MODE 6 times from first screen.
Auto Interval	Use the arrows to set the Auto-Interval (automatic data logger) ON or OFF. Use the LOG button to move from field to field. Use the arrows to change a value. Refer to Section 9.9 for complete information. Press MODE to step to the next parameter.	Press MODE 7 times from first screen.
Auto Power OFF (APO)	Use the arrows to set the auto power off timer to 5 or 15 seconds. Press MODE to step to the next parameter.	Press MODE 8 times from first screen.
Calibration date	View the date of the last calibration. Press MODE to exit the menu.	Press MODE 9 times from first screen.

10 Data Logger

The TG Series allows you to log readings manually or automatically. There are two memory banks, one for the manual logger and one for the automatic logger; each bank has 99 locations. After logging readings, you can recall and delete them per the instructions below. Each logged reading is stored with its date/time stamp, alarm status, and emissivity setting.

10.1 Manual Datalogger

To store a reading manually, short press the LOG button from either the SCAN or the HOLD mode. The display will **flash twice**, confirming that the reading has been stored. Up to 99 readings can be stored, after which the oldest readings will be overwritten.

To recall or delete logged readings, see Section 10.3 below.

To switch to the automatic data logging memory (Auto Interval) from the manual mode, short press the LOG button. You can then scroll through the readings that were logged in the automatic mode (Auto Interval). See the next section for Auto Interval details.

10.2 Automatic Data Logger (Auto Interval)





The TG Series allows you to automatically record a selectable number of readings (up to 99) at a programmable time interval (from 1 minute up to 96 hours and 56 minutes).

Important note: Before you begin setting up the automatic data logger, you must set the meter's time and date in the programming menu (Section 9), otherwise the data logger will not operate as expected.

Follow the steps below for configuring and running the automatic data logger.

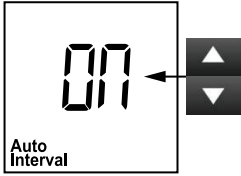
1. Pull and release the trigger to enter the HOLD mode.
2. Long press the MODE button to access the programming menu.
3. Short press the MODE button **seven** times to step to the Auto Interval menu.
4. Continue with the steps in Table 10.1. below.

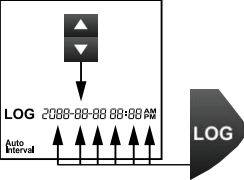
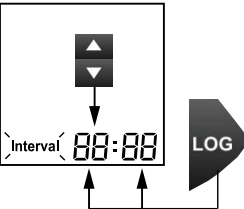
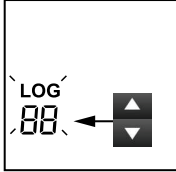
Table 10.1 Setting up the Auto Interval (automatic data logger) function.

	<p>Use the arrow buttons to set the mode ON (or OFF).</p>
	<p>Press the LOG button to move to the next screen.</p>
	<p>Use the arrow buttons to set the exact date and time that automatic data logging will begin. Use the LOG button to step from field to field and then to the next step. Digits flash when they are ready to be edited.</p>
	<p>Use the arrow buttons to set the sampling rate (interval of time between readings) from 1 minute to 96 hours and 59 minutes (00:01 to 96:59). Use the LOG button to step from hours to minutes and then to the next step.</p>
	<p>Use the arrow buttons to select the number of readings to log (99 maximum).</p>
	<p>Press LOG to complete the setup.</p>

After configuring the automatic data logger, the meter performs the following actions automatically:

- The meter starts logging at the time and date that you have designated.

- Readings are taken at the interval (rate) that you have specified.
- Data logging stops when the number of readings that you have selected has been reached.

10.3 Recalling and Deleting Logged Readings

To recall logged readings, short press either arrow button from the HOLD mode. The first memory bank you will see is the manual data log memory, as shown at left in Table 10.2, below. Use the arrow buttons to step through logged readings, long press to scroll quickly.

To switch to the automatic data logger memory bank (from the manual memory), short press the LOG button. The automatic data log memory screen is shown, below on right, in Table 10.2.

Table 10.2 Recalling logged readings.

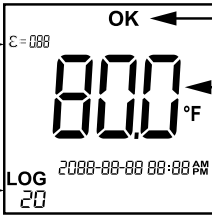
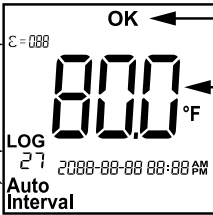
 <p>Diagram of the Manual data log recall screen. It shows a digital display with '800' and '°F'. Above the display is 'OK' with an arrow pointing left (5). To the left is 'ε=000' with an arrow pointing right (4). Below the display is 'LOG 20' with an arrow pointing right (3). To the right of the display is '2000-00-00 00:00 AM' with an arrow pointing left (2). The number '1' points to the rightmost digit of the display.</p>	 <p>Diagram of the Auto logging (Auto Interval) recall screen. It shows a digital display with '800' and '°F'. Above the display is 'OK' with an arrow pointing left (5). To the left is 'ε=000' with an arrow pointing right (4). Below the display is 'LOG 27' with an arrow pointing right (3). Below 'LOG 27' is 'Auto Interval'. To the right of the display is '2000-00-00 00:00 AM' with an arrow pointing left (2). The number '1' points to the rightmost digit of the display.</p>
<p>Manual data log recall screen</p>	<p>Auto logging (Auto Interval) recall screen</p>

1. Logged reading.
2. Time and date stamp of reading.
3. Memory location (in automatic memory mode, the text **Auto Interval** is also shown).
4. Emissivity setting at the time the reading was logged.
5. The **OK** icon indicates that there were no alarms active when the reading was logged. If there was a high or low alarm condition the display would show the **HI** or **LO** icon.

To delete a reading, long press the LOG button until the display flashes. When a reading is deleted, the reading digits switch to four dashes.

11 Maintenance

11.1 Battery Replacement and Storage

If the meter will not switch on, or if the low battery icon flashes on the display, replace the battery per the steps below.

1. Remove the two Phillips screws that secure the battery compartment (see Section 5, *Product Description*).
2. Remove the battery compartment cover.
3. Replace the 9 V battery observing correct polarity.
4. Dispose of the old battery responsibly, in accordance with all applicable regulations.
5. Reattach the compartment cover and secure it with the two screws.

If the meter is to be stored for more than 30 days, remove the battery and re-install it the next time the meter is used.

11.2 Cleaning

Wipe the meter housing with a soft, damp cloth and mild detergent when necessary. Do not use solvents or abrasives to clean the meter.

When cleaning the display and the lenses, use a very soft, lint free, lens cloth and a high quality lens cleaner. Use a lint free swab to clean the recessed lens. Use extra caution when cleaning the display and lenses, as scratching and other damage can result if wiped too vigorously with a rough or hard material.

12 Specifications

12.1 General Specifications

Display type	Color EBTN (Enhanced Black Twisted Nematic) LCD
Display size	1.1 x 1.1 in. (28.8 x 28.8 mm)
Battery power	9 V battery (included). When low battery icon flashes on the display, replace the battery.
Battery life	> 8 hours continuous temperature measurements
Automatic Power Off (APO)	5 or 15 seconds (selectable)
Alarms	High and Low Alarms with programmable set points
Data log memory	99 reading sets each for manual and automatic (Auto Interval) modes
Displayed error messages	'ERR' appears when the device requires service. 'OL' appears when a reading is over range. '-OL' appears when a reading is under range.
Operating conditions	32 to 122°F (0 to 50°C); 90% RH non-condensing (max.)
Storage conditions	-4 to 140°F (-20 to 60°C); 90% RH non-condensing (max.)
Safety / Certifications	CE61326 EN60825 PROP65 UKCA FDA CDRH / 60825 IP65 ingress rating (TG54-2 only) Drop-proof: 9.8 ft. (TG54-2); 3.3 ft. (TG56-2)
Supplied equipment	Meter, 9 V battery, Quick Start guide, storage pouch, and thermocouple (TG56-2 only)
Dimensions	TG54-2: 7.5 x 3.7 x 2.5 in. (192 x 94 x 64 mm) TG56-2: 7.5 x 4.9 x 2.5 in. (192 x 125 x 64 mm)
Weight	TG54-2: 10.3 oz. (292 g) TG56-2: 10.9 oz. (310 g)

12.2 IR Thermometer Specifications

Range	TG54-2: -22 to 1562°F (-30 to 850°C) TG56-2: -22 to 2372°F (-30 to 1300°C)
Out-of-range indication	OL (over range) and —OL (under range)
Resolution	0.1° maximum
Accuracy	-22 to 14°F (-30 to -10°C): ±7.2°F (±4.0°C) 14 to 32°F (-10 to 0°C): ±4.5°F (±2.5°C) 32° to 212°F (0° to 100°C): ±1.8°F (±1.0°C) > 212°F (100°C): ±1%
Accuracy specifications apply for ambient temperature conditions (21 to -25°C [69.8 to 75.2°F]) and with an emissivity setting of 0.95.	
Spectral Response	8 to 14 microns
Temperature Coefficient	±0.1°
Distance to Spot (D:S) ratio	20:1 for TG54-2; 30:1 for TG56-2
Response time	TG54-2: 250 ms TG56-2: ≤ 250 ms
Emissivity setting	0.01 to 1.00 with 5 presets

12.3 Laser Specifications

Laser type	Single point Class 2 laser
Wavelength	650 nm (±20 nm)
Power	<1mW

12.4 Thermocouple Specifications (TG56-2)

Type	Type K
Meter display range for thermocouple measurements	-22° to 1202°F (-30 to 650°C)
Supplied thermocouple range	-22 to 500°F (-30 to 260°C) Do not attempt to measure temperature > 500°F (260°C) with the supplied thermocouple.
Resolution	0.1°
Accuracy	Probe: ±3.0°F (±1.5°C) Meter: ±1.8°F (±1°C) or 1% (whichever is greater)

13 Customer Support

Customer Support Telephone List	https://support.flir.com/contact
Repair, Calibration, and Technical Support	https://support.flir.com

14 Limited 3–Year Warranty

This product is protected by FLIR's Limited 3–Year Warranty. Visit www.flir.com/testwarranty to read the Warranty.



Website

<http://www.flir.com>

Customer support

<http://support.flir.com>

Copyright

© 2023, FLIR Systems, Inc. All rights reserved worldwide.

Disclaimer

Specifications subject to change without further notice. Models and accessories subject to regional market considerations. License procedures may apply. Products described herein may be subject to US Export Regulations. Please refer to exportquestions@flir.com with any questions.

Publ. No.: NAS100131
Release: AC
Commit: 92852
Head: 92852
Language: en-US
Modified: 2023-07-14
Formatted: 2023-07-14

