

Raynger® Series 3i Plus

Handheld Infrared Thermometer



Operating Instructions



Raytek®
Fluke Process Instruments

Rev. B3 Aug 2018
4762049

Contacts

Fluke Process Instruments

Fluke Process Instruments North America

Everett, WA USA

Tel: +1 800 227 8074 (USA and Canada, only)

+1 425 446 6300

solutions@flukeprocessinstruments.com

Fluke Process Instruments Europe

Berlin, Germany

Tel: +49 30 478 0080

info@flukeprocessinstruments.de

Fluke Process Instruments China

Beijing, China

Tel: +86 10 6438 4691

info@flukeprocessinstruments.cn

Worldwide Service

Fluke Process Instruments offers services, including repair and calibration. For more information, contact your local office.

www.flukeprocessinstruments.com



WARRANTY

The manufacturer warrants this instrument to be free from defects in material and workmanship under normal use and service for the period of two years from date of purchase. This warranty extends only to the original purchaser. This warranty shall not apply to fuses, batteries, or any product that has been subject to misuse, neglect, accident, or abnormal conditions of operation.

In the event of failure of a product covered by this warranty, the manufacturer will repair the instrument when it is returned by the purchaser, freight prepaid, to an authorized Service Facility within the applicable warranty period, provided manufacturer's examination discloses to its satisfaction that the product was defective. The manufacturer may, at its option, replace the product in lieu of repair. With regard to any covered product returned within the applicable warranty period, repairs or replacement will be made without charge and with return freight paid by the manufacturer, unless the failure was caused by misuse, neglect, accident, or abnormal conditions of operation or storage, in which case repairs will be billed at a reasonable cost. In such a case, an estimate will be submitted before work is started, if requested.

THE FOREGOING WARRANTY IS IN LIEU OF ALL OTHER WARRANTIES, EXPRESSED OR IMPLIED, INCLUDING BUT NOT LIMITED TO ANY IMPLIED WARRANTY OF MERCHANTABILITY, FITNESS, OR ADEQUACY FOR ANY PARTICULAR PURPOSE OR USE. THE MANUFACTURER SHALL NOT BE LIABLE FOR ANY SPECIAL, INCIDENTAL OR CONSEQUENTIAL DAMAGES, WHETHER IN CONTRACT, TORT, OR OTHERWISE.

SOFTWARE WARRANTY

The manufacturer does not warrant that the software described herein will function properly in every hardware and software environment. This software may not work in combination with modified or emulated versions of Windows operating environments, memory-resident software, or on computers with inadequate memory. The manufacturer warrants that the program disk is free from defects in material and workmanship, assuming normal use, for a period of one year. Except for this warranty, the manufacturer makes no warranty or representation, either expressed or implied, with respect to this software or documentation, including its quality, performance, merchantability, or fitness for a particular purpose. As a result, this software and documentation are licensed "as is," and the licensee (i.e., the User) assumes the entire risk as to its quality and performance. The liability of the manufacturer under this warranty shall be limited to the amount paid by the User. In no event shall the manufacturer be liable for any costs including but not limited to those incurred as a result of lost profits or revenue, loss of use of the computer software, loss of data, the cost of substitute software, claims by third parties, or for other similar costs. The manufacturer's software and documentation are copyrighted with all rights reserved. It is illegal to make copies for another person.

Specifications subject to change without notice.

Content

CONTENT	4
1 SAFETY INSTRUCTIONS	6
2 PRODUCT DESCRIPTION	11
2.1 FEATURES	12
3 TECHNICAL DATA	13
3.1 MEASUREMENT SPECIFICATIONS	13
3.2 OPTICAL CHARTS.....	14
3.3 GENERAL SPECIFICATIONS.....	14
3.4 ELECTRICAL SPECIFICATIONS	15
3.5 SCOPE OF DELIVERY	16
4 BASICS	17
4.1 MEASUREMENT OF INFRARED TEMPERATURE	17
4.2 EMISSIVITY OF TARGET OBJECT.....	17
5 OPERATION	18
5.1 QUICK START.....	18
5.2 OVERVIEW	18
5.3 DISTANCE AND SPOT SIZE	19
5.4 HIGH TEMPERATURE NOSE	20
5.5 POWER SUPPLY.....	20
5.6 DISPLAY	20
5.7 SIGHTING.....	21
5.7.1 <i>Dual Laser</i>	21
5.7.2 <i>Red Dot Scope</i>	21
5.8 TEMPERATURE RECORDS	21
5.9 SAVE BUTTON.....	22
5.10 MENU	22
5.10.1 <i>Overview</i>	22
5.10.2 <i>EMS - Emissivity</i>	24
5.10.3 <i>Light</i>	24
5.10.4 <i>Profile</i>	24
5.10.5 <i>Trend</i>	26
5.10.6 <i>MnMx – Minimum, Maximum</i>	27
5.10.7 <i>Avg – Average</i>	27
5.10.8 <i>Lock – Trigger Button</i>	27
5.10.9 <i>Laser</i>	28
5.10.10 <i>Setup</i>	28
5.10.10.1 <i>Time/Date</i>	28
5.10.10.2 <i>Alarm</i>	29
5.10.10.3 <i>Transmissivity</i>	29
5.10.10.4 <i>Background Temperature</i>	29
5.10.10.5 <i>Bluetooth</i>	29
5.10.10.6 <i>Language</i>	29
5.10.10.7 <i>To Default</i>	30
5.10.11 <i>Log</i>	30

5.10.12 °C and °F	31
5.10.13 Scope	31
5.11 DATA DOWNLOAD	31
6 ACCESSORIES	32
7 WINDOWS SOFTWARE	33
7.1 INTRODUCTION	33
7.2 SYSTEM REQUIREMENTS	34
7.3 SOFTWARE INSTALLATION	34
7.4 COMMUNICATION	35
7.5 REAL-TIME DATA	37
7.5.1 Display	37
7.5.2 Settings	37
7.5.3 Replay	39
7.6 RECORDED DATA	40
7.6.1 Basic Data	40
7.6.2 Trend Data	41
7.6.3 Profile Data	41
7.6.3.1 Local	42
7.6.3.2 Device	43
8 MOBILE APP	46
8.1 REAL TIME VIEW	46
8.2 BASIC TEST DATA	47
8.2.1 Data Review	48
8.2.2 Data Review by Time	49
8.3 PROFILE TEST DATA	51
9 MAINTENANCE	54
9.1 TROUBLESHOOTING	54
9.2 LENS CLEANING	55
9.3 HOUSING CLEANING	55
9.4 LASER FAULT	55
9.5 BATTERY EXCHANGE	56
10 APPENDIX	57
10.1 DETERMINATION OF EMISSIVITY	57
10.2 TYPICAL EMISSIVITY VALUES	57
10.3 COMPLIANCE STANDARDS	60

Safety Instructions

1 Safety Instructions

This document contains important information, which should be kept at all times with the instrument during its operational life. Other users of this instrument should be given these instructions. Eventual updates to this information must be added to the original document. The instrument can only be operated by trained personnel in accordance with these instructions and local safety regulations.

Acceptable Operation

This instrument is intended only for the measurement of temperature. The instrument operates reliably in demanding conditions, such as in high environmental temperatures, as long as the documented technical specifications for all instrument components are adhered to. Compliance with the operating instructions is necessary to ensure the expected results.

Unacceptable Operation











The instrument should not be used for medical diagnosis.

Replacement Parts and Accessories



Use only original parts and accessories approved by the manufacturer. The use of other products can compromise the operation safety and functionality of the instrument.

Safety Instructions

Safety Symbols

	Risk of danger. Important information. See manual.
	Hazardous voltage. Risk of electrical shock.
	Warning Laser.
	Helpful information regarding the optimal use of the instrument.
°C	Celsius
°F	Fahrenheit
	Lithium-Ion Battery
	This product complies with the WEEE Directive (2002/96/EC) marking requirements. The affixed label indicates that user must not discard this electrical/electronic product in domestic household waste. Product Category: With reference to the equipment types in the WEEE Directive Annex I, this product is classed as Category 9 "Monitoring and Control Instrumentation." Do not dispose of this product as unsorted municipal waste. Go to Fluke's website for recycling information.
RoHS	Restriction of the Use of Certain Hazardous Substances in Electrical and Electronic Equipment
	Conforms to European Union directive.
	Conforms to China Metrology Certification CMC mark with Implement standard Q/SXAV 16
	Conforms to Canadian Standards Association Certification.
	Electromagnetic Compatibility Applies to use in Korea only. Class A Equipment (Industrial Broadcasting & Communication Equipment) This product meets requirements for industrial (Class A) electromagnetic wave equipment and the seller or user should take notice of it. This equipment is intended for use in business environments and is not to be used in homes.

Safety Instructions

	<p>Class A digital device: This equipment has been tested and found to comply with the limits for a Class A digital device, pursuant to Part 15 of the FCC Rules. These limits are designed to provide reasonable protection against harmful interference when the equipment is operated in a commercial environment. This equipment generates, uses, and can radiate radio frequency energy, and if it is not installed and used in accordance with the instruction manual, it may cause harmful interference to radio communications. Operation of this equipment in a residential area is likely to cause harmful interference, in which case the user will be required to correct the interference at their own expense.</p>
	<p>Conforms to the Appliance Efficiency Regulation (California Code of Regulations, Title 20, Sections 1601 through 1608) for small battery charging systems</p>

See figure below for the safety markings.

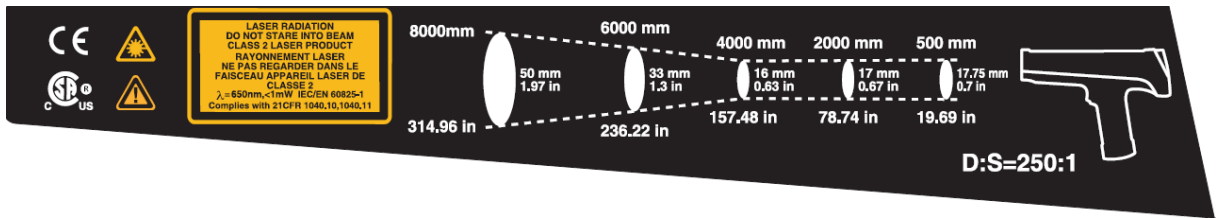

For Japanese versions:

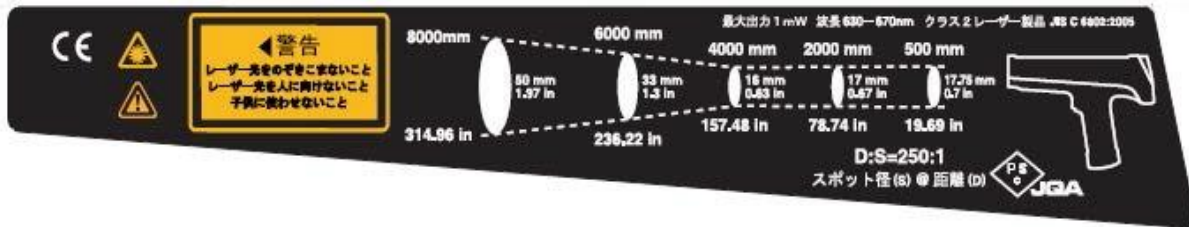

Model	Temperature	Optics	Spectral	Sighting	Bluetooth
RAYR3IPLUSNBT1MLJP	700 to 3000°C (1292 to 5432°F)	250:1	1 μm	Dual laser	No
RAYR3IPLUSNBT1MSCLJP	700 to 3000°C (1292 to 5432°F)	250:1	1 μm	Dual laser + scope	No
RAYR3IPLUSNBT2MLJP	400 to 2000°C (752 to 3632°F)	250:1	1.6 μm	Dual laser	No
RAYR3IPLUSNBT2MSCLJP	400 to 2000°C (752 to 3632°F)	250:1	1.6 μm	Dual laser + scope	No



Warnings

A warning identifies conditions and procedures that are dangerous to the user.

To prevent possible electrical shock, fire, or personal injury follow these guidelines:

- Read all safety information before you use the product.
- Use the product only as specified, or the protection supplied by the product can be compromised.
- Do not use the product around explosive gas, vapor, or in damp or wet environments.
- Do not use the product if it operates incorrectly.
- See emissivity information for actual temperatures. Reflective objects result in lower than actual temperature measurements. These objects pose a burn hazard.
- Do not look directly into the laser with optical tools (for example, binoculars, telescopes, microscopes). Optical tools can focus the laser and be dangerous to the eye.
- Do not look into the laser. Do not point laser directly at persons or animals, or indirectly off reflective surfaces.
- Use the product only as specified, or hazardous laser radiation exposure can occur.
- Do not use laser viewing glasses as laser protection glasses. Laser viewing glasses are used only for better visibility of the laser in bright light.
- Do not open the product. The laser beam is dangerous to eyes. Have the product repaired only through an approved technical site.
- Have an approved technician repair the product.

Cautions

A caution identifies conditions and procedures that can cause damage to the instrument or the equipment under test.

For safe operation and maintenance of the product:

- Remove the batteries if the product is not used for an extended period of time, or if stored in temperatures above 50°C (122°F). If the batteries are not removed, battery leakage can damage the product.
- Recharge the batteries when the low battery indicator appears to prevent incorrect measurements.
- Have the product repaired before use if the batteries leak.
- Do not short the battery terminals.
- Do not keep cells or batteries in a container where the terminals can be shorted.
- Do not put battery cells and battery packs near heat or fire. Do not put in sunlight.

To avoid damage to the product or the equipment under test, protect them from:

- EMF (electro-magnetic fields) from arc welders, induction heaters, etc.
- Static electricity

Safety Instructions



Battery Warning

The battery is a safety device. Do not attempt to disassemble or alter the battery. Always observe the following precautions:

- Do not short-circuit the battery by directly connecting the negative terminals with positive terminal.
- Do not heat the battery or discard it in a fire.
- Do not expose the battery to temperatures over 50°C (122°F). Keep the battery away from fire and other heat sources.
- Do not charge the battery near a heat source, such as, a fire or heater.
- Do not leave the battery in direct sunlight.
- Do not pierce the battery with a sharp object, hit or step on it.
- Do not use a damaged battery.
- Do not apply solder to a battery.
- Do not connect the battery to an electrical power outlet.

To prevent the battery bursting, igniting, or fumes from the battery causing equipment damage, always observe the following precautions:

- Do not immerse the battery in water or allow it to get wet.
- Do not place the battery in a microwave oven or pressurized container.
- If the battery leaks or emits an odor, remove it from all possible flammable sources.
- If the battery emits an odor or heat, is deformed or discolored, or in a way appears abnormal during use, recharging or storage, immediately remove and stop using it.



Instrument

- If the unit is exposed to significant changes in ambient temperature (hot to cold or cold to hot), allow 30 minutes for temperature stabilization before taking measurements.
- Do not operate the unit near large electrical or magnetic fields such as arc welders and induction heaters. These fields can cause measurement errors.
- For the short wavelength units (e.g., 1.0 μm and 1.6 μm) — avoid taking temperature measurements in bright sunlight. High levels of ambient light may produce apparently valid high-temperature readings when no target is in the thermometer's field-of-view.

2 Product Description

The Raynger 3i Plus Series of instruments are portable infrared temperature measurement devices. Each model is rugged and easy to use for making fast, noncontact, nondestructive temperature measurements. They can measure product temperatures during manufacturing or storage without contaminating or marring the product.



Figure 1: Raynger 3i Plus Series

The Raynger 3i Plus Series thermometer is an upgraded version of Ranger 3i Series. It provides high performance with better accuracy, increased optical resolution, a larger memory and other highlighted functions. It is the best solution for monitoring process temperature and initial breakdown for the steel, cement, heat treatment, and petrochemical industries.

Refer to the following table for a list of standard models along with their temperature ranges, optical resolutions, spectral ranges, and sighting systems.

Model	Temperature	Optics	Spectral	Sighting	Wireless
RAYR3IPLUS1ML	700 to 3000°C (1292 to 5432°F)	250:1	1 μm	Dual laser	Bluetooth® 4.0
RAYR3IPLUS1MSCL	700 to 3000°C (1292 to 5432°F)	250:1	1 μm	Dual laser + scope	Bluetooth® 4.0
RAYR3IPLUSNBT1ML	700 to 3000°C (1292 to 5432°F)	250:1	1 μm	Dual laser	-
RAYR3IPLUSNBT1MSCL	700 to 3000°C (1292 to 5432°F)	250:1	1 μm	Dual laser + scope	-
RAYR3IPLUS2ML	400 to 2000°C (752 to 3632°F)	250:1	1.6 μm	Dual laser	Bluetooth® 4.0
RAYR3IPLUS2MSCL	400 to 2000°C (752 to 3632°F)	250:1	1.6 μm	Dual laser + scope	Bluetooth® 4.0
RAYR3IPLUSNBT2ML	400 to 2000°C (752 to 3632°F)	250:1	1.6 μm	Dual laser	-
RAYR3IPLUSNBT2MSCL	400 to 2000°C (752 to 3632°F)	250:1	1.6 μm	Dual laser + scope	-

Table 1: Available Models

Product Description

2.1 Features

The Raynger 3i Plus Series has the following features:

- Dual laser sighting
- Current temperature plus MAX, MIN, DIF, AVG temperatures
- Audible/visual alarms for target temperature, ambient temperature, and low battery
- Adjustable emissivity and predefined emissivity table
- Background temperature compensation
- Transmissivity compensation
- User selectable °C or °F
- Profile definition to convenient measurement
- Curve to display trend with selectable time span
- Tripod mount
- Auto off
- 12- or 24-hour real time clock
- Last reading hold (20 seconds)
- English and Chinese user interface
- Data storage: up to 4,900 units with location, date, and time stamp
- Trigger lock
- USB 2.0 computer interface
- Lithium-ion battery, charged with or without unit
- Red dot scope sighting (scope model)
- Special material for 120°C (248°F) high temperature
- Warning system to prevent high temperature damage
- Bluetooth® wireless technology¹ for communication with a mobile device
- Documenting personal computer (PC) software

¹ Bluetooth® is a registered trademark owned by Bluetooth SIG, Inc.

3 Technical Data

3.1 Measurement Specifications

Temperature Range

1M	700 to 3000°C (1292 to 5432°F)
2M	400 to 2000°C (752 to 3632°F)

Spectral Response

1M	1.0 μm
2M	1.6 μm

Optical Resolution D:S¹

All models	250:1 16 mm spot @ 4000 mm distance (0.63 in @ 157 in)
------------	---

System Accuracy²

1M	\pm (0.5% of reading + 1°C) for \leq 2700°C \pm (0.5% of reading + 2°F) for \leq 4892°F \pm 2% of reading for $>$ 2700°C (4892°F)
2M	\pm (0.5% of reading + 1°C) \pm (0.5% of reading + 2°F)

Repeatability³

\pm (0.3% of reading + 1°C)
\pm (0.3% of reading + 2°F)

Temperature Resolution

Display	\pm 0.1°C (0.1°F)
---------	---------------------

Exposure Time

40 ms (95%)

Display Refresh Time

200 ms

Emissivity

0.01 to 1.00

Signal Processing

Max / Min / Avg / Diff

¹ at 90% energy in minimum and distance 4000 mm (157 in.)

² Calibration geometry at ambient temperature 23°C \pm 2°C (73°F \pm 4°F), emissivity = 1.0

³ Calibration geometry at ambient temperature 23°C \pm 2°C (73°F \pm 4°F), emissivity = 1.0

Technical Data

3.2 Optical Charts

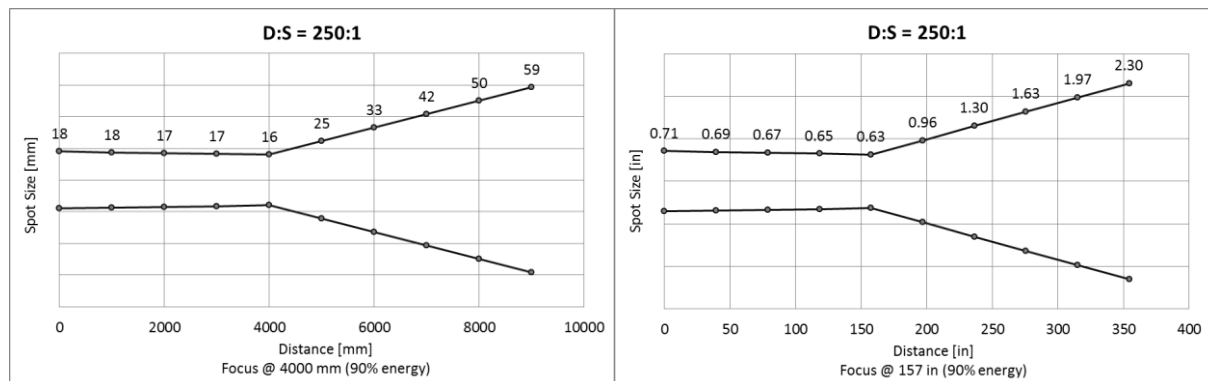

Figure 2: Spot Size Charts

3.3 General Specifications

Operating Temperature	0 to 50°C (32 to 122°F)
Storage Temperature	-20 to 60°C (-4°F to 140°F) without battery
Operating Humidity	10 to 90% RH, not condensing at 30°C (86°F)
Environmental Rating	IP40 (NEMA 1)
Drop Performance	1 m (3.3 ft)
Operating Altitude	≤ 2 000 m (6,500 ft.)
Storage Altitude	≤ 12 000 m (40,000 ft.)
Size	
Standard	218 x 172 x 74 mm (8.6 x 6.8 x 2.9 in.)
with scope	218 x 222 x 74 mm (8.6 x 8.7 x 2.9 in.)
Weight	
Standard	700 g (25 oz)
with scope	950 g (34 oz)
Display	Illuminated backlight display (On/Off, white color, orange color) display Hold (20 s)
Laser	Dual laser (EN60825 Class 2, FDA Class II)

3.4 Electrical Specifications

Power Supply	Battery or USB
Battery	Lithium-ion, single cell, 3.6 V, 2500 mAh
Battery Life¹	24 h
USB	Version 2.0, Mini USB (type B)
Bluetooth	Version 4.0 (for Bluetooth models only) using Fluke 521-4006 module specified as following:

Item	Specifications
Frequency	2402 MHz in 2 MHz steps
Data Rate and Modulation	1Mbps, GFSK
Number of Channels	40:37 data / 3 advertising (0,12,39)
Receive Sensitivity (w/ chip antenna)	-95 / -89 dBm
Output Power	-23 to 4 dBm
Link Budget	Up to 99 dB
RX/TX Turnaround	150 μ s



Figure 3: Bluetooth Specification

¹ Laser: off, Bluetooth: off

Technical Data

3.5 Scope of Delivery

The scope of delivery includes the following:

- Raynger 3i Plus
- Carrying case
- CD with software for real-time graphic temperature display and data download, and operator's manual (PDF format)
- Lithium-ion battery 2.5 Ah
- Mini USB port adapter (100 – 240 VAC 50/60 Hz)
- Mini USB to DC jack converter for charging battery separately
- 1.5 m (4.9 ft.) computer cable with USB to Mini USB
- Operator's manual (printed format)

4 Basics

4.1 Measurement of Infrared Temperature

All objects emit an amount of infrared radiation according to their surface temperature. The intensity of the infrared radiation changes according to the temperature of the object. Depending on the material and surface properties, the emitted radiation lies in a wavelength spectrum of approximately 1 to 20 μm . The intensity of the infrared radiation ("heat radiation") is dependent on the material. For many substances this material-dependent constant is known. It is referred to as "emissivity value" (see section 10.2 [Typical Emissivity Values](#), page 57).

Infrared thermometers are optical-electronic sensors. These sensors are able to detect "radiation of heat." Infrared thermometers are made up of a lens, a spectral filter, a sensor, and an electronic signal-processing unit. The task of the spectral filter is to select the wavelength spectrum of interest. The sensor converts the infrared radiation into an electrical signal. The signal processing electronics analyzes the electrical signal and converts it into a temperature measurement. As the intensity of the emitted infrared radiation is dependent on the material, the required emissivity can be selected on the sensor.

The biggest advantage of the infrared thermometer is its ability to measure temperature without touching an object. Consequently, surface temperatures of moving or hard to reach objects can easily be measured.

4.2 Emissivity of Target Object

Determine the emissivity of the target object as described in section 10.1 [Determination of Emissivity](#), page 57. If emissivity is low, measured results could be falsified by interfering infrared radiation from background objects (e.g., heating systems, flames, fireclay bricks, etc., close beside or behind the target object). This type of problem can occur when measuring reflecting surfaces and very thin materials such as plastic films and glass.

This measuring error can be reduced to a minimum if particular care is taken during installation, and the sensing head is shielded from these reflecting radiation sources.

Operation

5 Operation

5.1 Quick Start

To use the instrument right away, complete the following steps:

1. Point the instrument at the object the user wants to measure (as perpendicular as possible to the object) and pull the trigger. The current temperature (in °C or °F), emissivity value, and maximum and minimum measured temperature are displayed.
2. Change the emissivity value to correspond to the targeted material by pressing the <F1> key twice to show the target material table. Press the ▲ and ▼ buttons to select the target material.



For complete definitions of the instrument's modes and functions, and for full explanation of operation, refer to the later sections.

5.2 Overview

Portable infrared thermometers measure surface temperatures without touching the surface. They collect the infrared energy radiated by a target and compute its surface temperature. They also compute the running average, and maximum/minimum/differential temperatures and present them on a digital display in either degrees Celsius or Fahrenheit. The instrument is battery-powered or can be powered by a computer's USB interface. Internal memory circuits store temperature data for later recall, and a data-logging feature allows users to store and multiple temperature, emissivity, and alarm readings (valuable for comparative analysis).

The following figure shows the features of the portable infrared thermometer.



Figure 4: Portable Thermometer with Scope

The portable thermometer has the following:

Trigger: One-stage trigger, which activates the unit to take temperature readings.

Control Panel and Display: All controls (except the trigger) are located on the control panel. The display shows temperature and setup values, mode and operating information.

Mini USB Output: Connects the instrument to the PC for downloading data or to DC Adaptor for charging the battery.

Nose with Temperature Sensor inside: Has the thermistor on the nose for high temperature protection.

Sighting System: Laser or red dot scope sighting is provided with each model for aiming. Note: Read the laser warning label before operating the laser.

Polaroid Frame: To adjust brightness of red dot scope.

5.3 Distance and Spot Size

As the distance (D) from the object being measured increases, the spot size (S) of the area measured by the instrument becomes larger. For the relationship between distance and spot size (D:S), see section 3.2 [Optical Charts](#), page 14.

During measurements, please make sure that the target is larger than the instrument's measurement spot size at that distance. The smaller the target, the closer user should be to it.

Operation

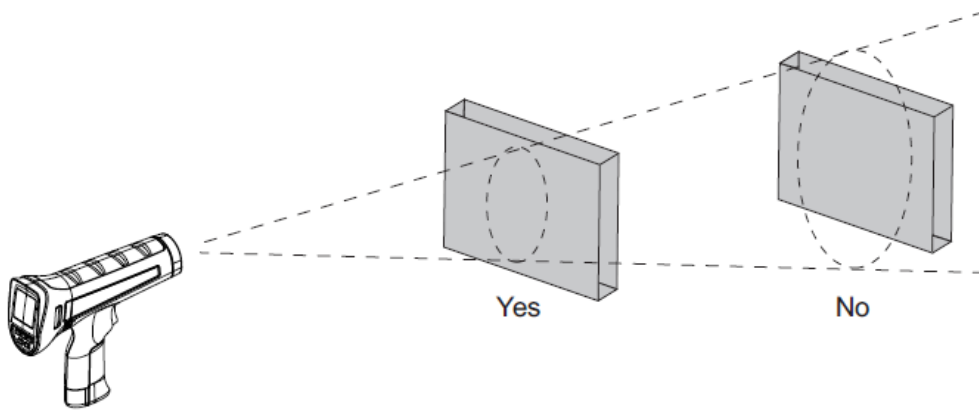

Figure 5: Field of View



For accurate measurements the target size must be at least two times bigger than the Spot diameter

5.4 High Temperature Nose

The instrument has a specially designed nose with high temperature resistant plastic material to avoid damage from high temperature targets. On the other hand, please avoid over exposure when aiming at a high-temperature target.

There is a temperature sensor inside the nose. During measurement, the instrument is monitoring the temperature of the nose. If it is too hot, there will be a warning on the LCD display (ambient highlight display and backlight change to red plus audible buzzer). Please move the unit away from the high-temperature target when seeing this alarm.

5.5 Power Supply

The instrument is powered by a battery or USB cable when connect to the PC. The battery is located in the base of the handle.

The instrument provides two charging methods:

- AC adaptor through Mini USB port on the right side of the unit.
- Remove the battery, and use the AC adaptor plus Mini USB-to-DC jack converter to charge. An indicator on the battery will show a “charging” red light and “charge complete” green light.



The instrument can be powered when connecting the USB cable to the PC but there is no charging since many USB ports have not enough power capability!

5.6 Display

The display retains the last infrared measurement for 20 s when the trigger is released and <HOLD> is shown on the display. To hold the infrared temperature, release the trigger until <HOLD> shows on the display.

If the measured value is above the upper threshold, the display shows <Hi>. If the measured value is below the lower threshold, the display shows <Lo>.

5.7 Sighting

5.7.1 Dual Laser

All models use a dual laser method to show the measurement spot position and size. The two laser points simulate the diameter of the spot circle. The diameter shown by the 2 laser dots is matched quite well with 90% real spot size at focus distance (4 m (13 ft) away from the unit), but the laser diameter becomes greater at a shorter distance. The worst situation is at the lens (0 m (0 ft) away), you can see the 2 laser holes are outside the lens.

5.7.2 Red Dot Scope

The scope models for the Raynger 3i Plus series provide an additional red dot scope; the measurement target can be seen through the scope. That aiming system can be used when the laser points are hard to see due to the brightness of the target.

The scope's red dot shows the center of the measuring spot circle, which does not display on the real object under measurement.

The intensity of the field sight can be adjusted by rotating the knob on the top of the instrument while keeping the brightness of the red dot. This function is helpful for the user to see clearly the red dot position when the instrument is measuring high-temperature objects.

If the scope's red dot does not match with the circle of the two laser points, use the following adjustment method:

1. Open the two circular rubber caps on the top of the unit, and the scope's two adjustable screws are shown.
2. Affix the unit to a tripod.
3. Aim at a target 4 m (13 ft.) off in the distance, like a wall, for viewing the two lasers clearly.
4. Adjust the two screws on the aiming scope to the center of the two laser points. Please try to look straight through the aiming scope.
5. Remove the unit from the tripod.
6. Close the two circular rubber caps.

Warning: Please do not use the unit with the two rubber caps open, since unexpected contact with the screws may introduce noise pulse to the units, resulting in noise readings or disorder of the display

5.8 Temperature Records

The instrument can store measurement records, including time, date, emissivity, and measurement record numbers. It can store 1,000 records for basic test data, 10 pcs trend display and 300 records for profile.

The following types of data are available:

- **Basic test data:** Test data without a dedicated setting like profile. User can record random measurement data in this area with a maximum 1,000 records.
- **Trend data** the data saved under trend mode which includes three screens of data with 360 test values. The data will be saved in a curve format and the user can review the value of each test point with PC software. Press <View> to review the trend picture. User can press up and

Operation

down arrows to select each saved trend data. The user can then use left and right arrows to view the three screens for each piece of trend data.

- **Profile test data:** Profile setting under which 300 test data records (maximum) are saved. Profile test data is defined as the test data under profile setting which could save maximum 300 records. By using the load value of each profile, these test data has been divided by group according to the profile setting in PC software. User can find the temperature distribution status in one group and convenient the measurement by using the setting in advance.

5.9 Save Button

The instrument can store up to multiple data records. The information below is stored in each record:

- Record number
- IR temperature in °F or °C
- Date/Time
- Emissivity

To save the current temperature reading (Basic test data):

1. Pull the trigger to take a measurement.
2. Release the trigger to stop taking the measurement.
3. Push the <Save> soft key to enter the Save menu.
4. Push the <Yes> soft key to save the reading.

The user can also push the <Cancel> soft key to not save the reading.

The <Save> soft key is also used to save records as profile or trend.

5.10 Menu

The instrument can display two languages, English and Simplified Chinese. To change the displayed language, see section 5.10.10.6 [Language](#), page 29.

5.10.1 Overview

There are many settings that can be changed with the menu. The following figure shows the LCD and menu interface.

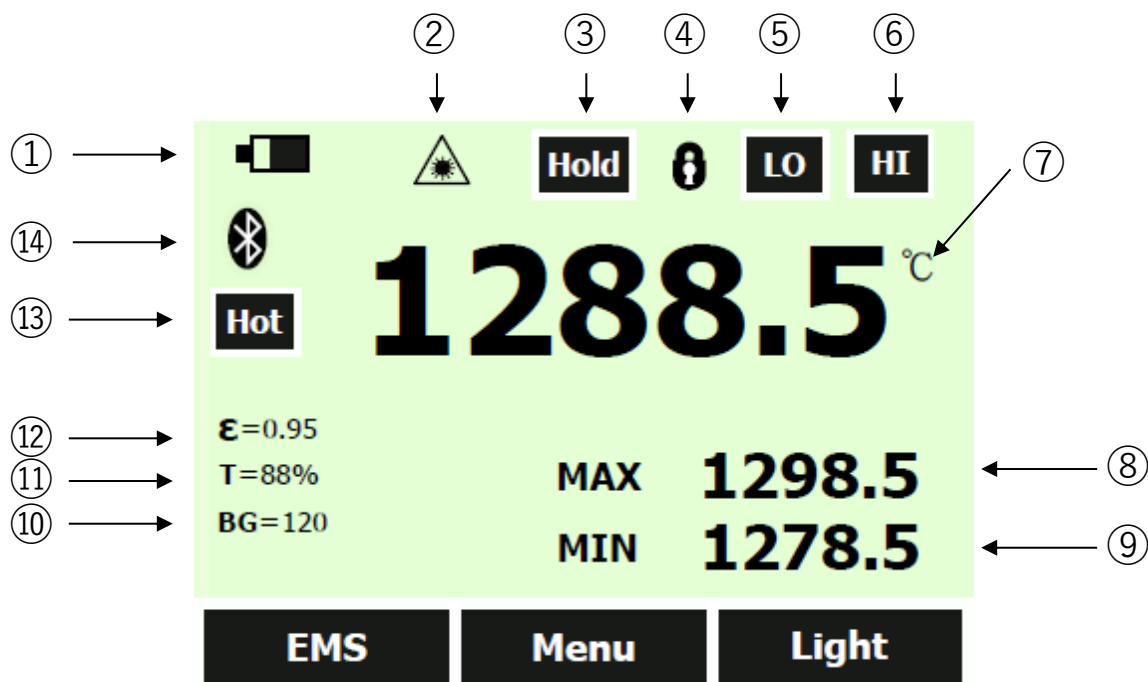

Figure 6: User Interface

Number	Description	Number	Description
①	Battery Symbol	⑧	Max. Value Display
②	Laser Indicator	⑨	Min. Value Display
③	Scan/Hold	⑩	Background Temp. Compensation
④	Lock/Unlock	⑪	Transmissivity
⑤	Low Temperature Alarm	⑫	Emissivity
⑥	High Temperature Alarm	⑬	“Hot” Warning Area
⑦	Main Temperature Display	⑭	Bluetooth Symbol

Table 2: Menu Overview

The Raynger 3i Plus series has three soft keys (F1, F2, and F3) just below the LCD display. There is a “Soft Key Bar” on the LCD above the three soft keys to define their active function. By using soft keys, the instrument has a convenient menu function. Each menu item and function is explained in detail in the following sections.

In addition to the soft keys, there are also the <Save> and <Return> soft keys below the LCD display. Selecting the <Menu> soft key advances the menu to the next level. The following table shows the top-level description of the menu.

Operation

Level	<F1>	Description	<F2>	<F3>	Description
1	EMS	Sets the emissivity value	Menu	Light	Toggles the LCD backlit
2	Profile	Calls predefined profiles	Menu	Trend	Reviews recorded trends
3	MnMx	Enables minimum/maximum	Menu	Avg	Enables average/difference
4	Lock/Unlock	Locks/unlocks the trigger button	Menu	Laser	Toggles the laser
5	Setup	Time/Date, Alarm, Transmissivity, Background Temperature, Bluetooth, Language	Menu	Log	Review/Delete recorded temperatures
6	°C/°F	Toggles between C and F	Menu	Scope	Toggles the red dot in the scope

<Save> button

Save Reading to Memory

<Return> button

Back to Last Menu

Table 3: Top-Level Menu Description

5.10.2 EMS - Emissivity

The <Emissivity> menu includes a list of pre-defined materials and their typical emissivity values, see section 10.2 [Typical Emissivity Values](#), page 57. The instrument's default emissivity value is 1.00.

To access the Emissivity menu:

1. Push the <Menu> soft key until EMS (emissivity) is shown as the right soft key function.
2. Push the <EMS> soft key.

The user can push the table soft key to access the emissivity list. The user can also push the <No.> soft key to manually enter the typical emissivity of a material.

If the Emissivity table is accessed, a list of materials and their suggested emissivity is shown.

1. Use the down arrow to navigate through the list.
2. Push the <Done> soft key to choose the desired material.

To enter an emissivity value manually:

1. Push the <No.> soft key.
2. Use the down or up arrow soft key to change the entry. Hold down the up or down arrow soft key to increase the rate of change.
3. Push the <Done> soft key when finished to return to the main menu.

5.10.3 Light

The instrument has a backlit display. The backlight can be toggled by pushing the <Light> soft key.

5.10.4 Profile

To manage regular testing points, different profiles can be created by the Raynger 3i Plus software. Each profile includes the settings for Emissivity, Alarm Temperature, Transmissivity, Background Temperature, etc., as well as a unique profile name. When the setting is ready, the user can simply select the profile name to call up the settings, save data and review accordingly.

The maximum number of test points is 300. These test points are arranged in three levels, and the maximum allowed for the second level is 50. The first and second levels could be represented by three

characters (combination of number and letter), and the third level can be defined by a sequential test point number. The user can define the unique structure to meet complicated needs.

The following example can be regarded as a **sequential structure**:

- **First level:** WGA and WGB represent two heating ovens.
- **Second level:** ECA and ECB belong to WGA. The second level can be set up to 50 test points.
- **Third level:** Indicates the location number in each second-level folder. The sums for location numbers in all third levels can up to 300 points.

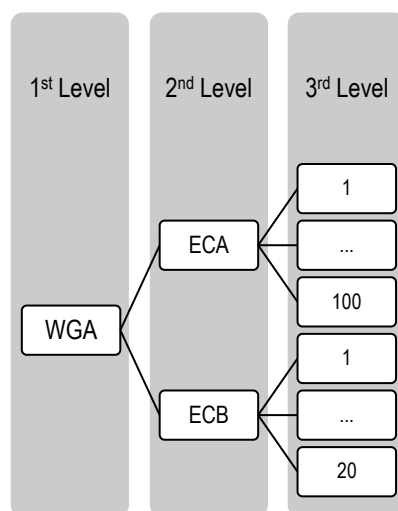

Examples are as follows:

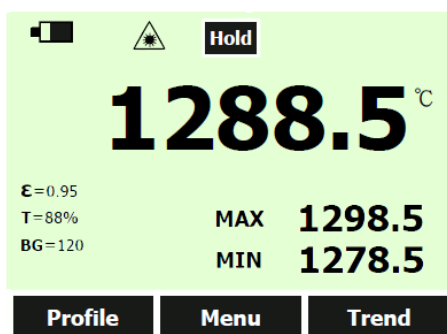

Press <Profile> to enter the first level menu selection. Each displayed name is edited under the PC interface, and then uploads to the instrument. Here the user can continue to the next screen using the arrow keys if the item quantity is more than 15.



Press <Next> to continue to the second level menu, and upload to the instrument. Here, the user can also continue to the next screen using the arrow keys.

Operation



Choose the <Next> button, and the user can select location number and use various preset parameters to perform test.

In the following example, selecting profile code WGA ECA location number 98 has a setting of:

- High -temperature Alarm HI = 2120
- Low -temperature Alarm LO = 1836
- Emissivity ϵ = 0.95
- Transmissivity T = 88%
- Background Temperature Compensation BG = 120

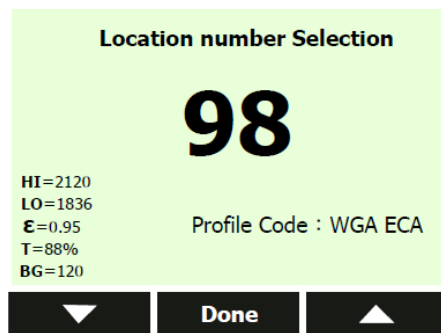

Press <Done> to adopt this setting for this location and perform normal measurement.

If the user chooses to save the test data, the test point number will auto jump to the next one. If the user doesn't save the test data, the profile will keep the current test point.

Note: In this mode, the user can modify the emissivity values to adapt to field test conditions and use <Save> soft key to save this change.

5.10.5 Trend

Press the <Menu> button, until <Trend> displays for the right function key and press enter.

The instrument provides two modes to display the trend.

- <Auto>: The user does not need to consider how to set upper and lower limits for the displayed temperature. The temperature axis will be changed according to the actual measurement range. After the user chooses an appropriate time span, the curve can be displayed on the screen.
- <Manual>: The user should manually set the upper and lower limits for the Y-axes and the time span for the X-axes in accordance to his needs.

Press the left key to enter the <Auto> mode. Enter the time axis settings. Press the arrow keys to select the time interval. The unit can select 20 ms, 200 ms, 1 s, 10 s, 1 min, and 5 min time spans. After the user has confirmed the selected time span and presses the trigger, the trend can be displayed on the screen.

User also can choose the <Manual> mode to set the upper and lower limits and the time span.

The instrument will save three pages of curves when the user presses <Save>.

The maximum record in trend mode is 10 pcs curve; each curve can be displayed in three pages.

The figure below is under trend auto mode.

1. The data show on Y-axis is automatically displayed using the maximum and minimum value in the record period.
2. The data show on X-axis is calculated by the time span the user has chosen.

Every page can store 120 points, so if you choose a time span with 200 ms, the maximum value on X-axis should be 24 s.

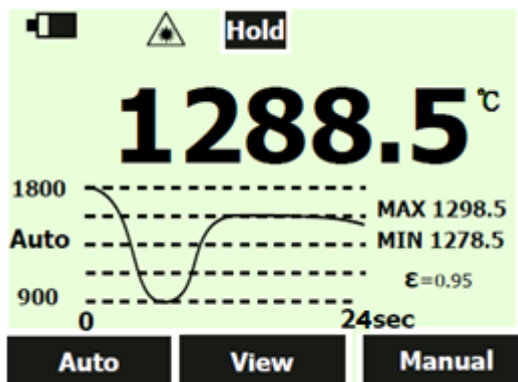

5.10.6 MnMx – Minimum, Maximum

The instrument can measure the minimum (Min), maximum (Max) temperatures each time a reading is taken.

To turn on the Min-Max mode:

1. Push the <Menu> soft key until <MnMx> (Min-Max) is shown as the F1 soft key function.
2. Push the <MnMx> soft key.

The display shows now the minimum and maximum readings.

5.10.7 Avg – Average

The instrument can measure the average (Avg) and differential (Dif) temperatures each time a reading is taken.

To turn on the Avg/Dif mode:

1. Push the <Menu> soft key until <Avg> shows as the right soft key function.
2. Push the <Avg> soft key.

The display shows the average reading and the differential reading which is the difference between the present minimum and the maximum temperature.

Averaging can be useful when an average temperature over a specific duration is desired, or when a smoothing of fluctuating temperature is required. The signal is smoothed depending on the defined time basis. In other words, the output signal tracks the detector signal with significant time delay but noise and short peaks are damped.

5.10.8 Lock – Trigger Button

The instrument's trigger can be locked to take temperature readings continuously without pressing the trigger button all the time.

To lock the trigger button:

1. Push the <Menu> soft key until the lock symbol shows as the left soft key function.

Operation

2. Push the soft key to lock the trigger. The lock symbol  is shown on the display to designate a locked trigger. When the trigger is locked, the soft key changes to unlock. Push this soft key to unlock the trigger.

5.10.9 Laser

The laser is to be used for aiming purposes only. It turns off when the trigger is released.

To enable or disable the laser:

1. Push the <Menu> soft key until <Laser> shows as the right soft key function.
2. Push the <Laser> soft key to enable or disable the laser. The laser symbol is shown on the display when the laser is enabled.



**To prevent eye damage and personal injury, do not look into the laser. Does not point
Do not point the laser directly at persons or animals or indirectly off reflective surfaces!**



The laser automatically turns off at 48°C (118°F) internal temperature!

5.10.10 Setup

From the <1M Setup> / <2M Setup> menu, the time and date, alarm, transmissivity, background temperature, display language and Bluetooth switch can be changed. In that setup menu, transmissivity, and background temperature can be set by the user.

5.10.10.1 Time/Date

To change the time on the instrument:

1. Push the <Menu> soft key until <Setup> shows as the left soft key function.
2. Push the <Setup> soft key to enter the <Setup> menu.
3. Push the down arrow soft key to select <Time/Date>.
4. Push the <Enter> soft key.
5. Push the <Time> soft key.
6. Push the necessary time format soft key (24-hour or 12-hour).
7. Use the up and down soft keys to the desired hour.
8. Push the <Next> soft key to select the minutes.
9. Use the up and down soft keys to the desired minute.
10. When in 12-hour mode, push the <Next> soft key to highlight the AM/PM parameter.
11. Use the up and down soft key to change to <AM> or <PM>.
12. Push the <Done> soft key when finished. The display reverts to the first page of the Time/Date menu.

To change the date on the instrument:

1. From the main menu, push the <Menu> soft key until <Setup> shows as the left soft key function.
2. Push the <Setup> soft key.
3. Push the down arrow soft key to select <Time/Date>.
4. Push the <Enter> soft key.
5. Push the <Date> soft key.
6. Select the date format: <Day/Month/Year> (DMY) or <Month/Day/Year> (MDY).

7. Use the up and down soft keys to change the selected parameter.
8. Push the <Next> soft key and the arrow soft keys to select the month, date, or year parameters.
9. Use the up and down soft keys to change the selected parameter.
10. Push the <Next> soft key to move through each parameter.
11. Push the <Done> soft key when finished. The display reverts to the start of the <Time/Date> menu.

5.10.10.2 Alarm

The instrument has a programmable alarm to designate high or low readings, depending on the thresholds entered. When the alarm level is reached, an alarm will sound and the display color will flash orange and white, and <Hi> or <Lo> will flick. To set either the high or low alarm:

1. Push the <Menu> soft key until <Setup> shows as the right soft key function.
2. Choose the <Alarm> soft key to access the <Alarm> menu.
3. Push either the <Hi> or <Lo> soft key, depending on which alarm will be set.
4. Push the <On> soft key to turn the alarm on.
5. Push the <Off> soft key to turn the alarm off.
6. Use the <Set> soft key to access the <Hi> or <Lo> Alarm Set menu.
7. Use the down or up soft keys to change the alarm setting.
8. Once the necessary settings have been entered, push the <Done> soft key.

5.10.10.3 Transmissivity

To change the <Transmissivity> value when measuring target temperature through glass windows:

1. Push the <Menu> soft key until setup shows as the right soft key function.
2. Choose <Transmissivity> to access the <Alarm> menu.
3. Push the <On> soft key to turn the transmissivity on.
4. Use the <Set> soft key to access the transmissivity set menu.
Transmissivity could be set between 1% and 100%.
5. Push the <Off> soft key to turn <Transmissivity> off.

5.10.10.4 Background Temperature

This feature is useful when the target emissivity is below 1.0 and the background temperature is not significantly lower than the target temperature. For instance, the higher temperature of a furnace wall could lead to too-high temperatures being measured especially for lower emissivity targets. A built-in ambient background temperature utility compensates for the impact of the reflected radiation in accordance to the reflective behavior of the target. User can set this function as follows:

1. Push the <Menu> soft key until setup shows as the right soft key function.
2. Choose <Background Temperature> to access the <Alarm> menu.
3. Push the <On> soft key to turn the <Background Temperature> on.
4. Use the <Set> soft key to access the <Background Temperature Set> menu.
5. Push the <Off> soft key to turn the <Background Temperature> off.

5.10.10.5 Bluetooth

Menu to turn Bluetooth on and off (for Bluetooth models only).

If no communication is detected via Bluetooth within 5 minutes, the unit will return to normal operation.

5.10.10.6 Language

To change the display language:

1. From the main menu, push the <Menu> soft key until <Setup> shows as the left soft key function.
2. Push the <Setup> soft key.

Operation

3. Use the down arrow soft key to move the indicator to <Language>.
4. Push the <Enter> soft key.
5. Push the <F1> soft key to complete the language selection or push the <Back> soft key to return to the Setup menu.

5.10.10.7 To Default

To restore the instrument to the original factory default settings, press the <To Default> soft key. The following table provides the values in case of a factory default.

Parameter	Factory Default
White Backlight	OFF
Orange Backlight	OFF
Scope	OFF
Laser	OFF
Buzzer	OFF
Date	2014.01.01
Date Format	DD/MM/YY
Time	00:00:00
Time Format	24-Hour
Bluetooth Enable	False
Language	English
Temperature Unit	Celsius
Emissivity	1.00
Transmissivity Enable	OFF
Transmissivity	100%
Background Compensation Enable	OFF
Background Compensation Temperature	25°C (77°F)
High Alarm Enable	OFF
High Alarm Temperature	Upper limit of measurement range
Low Alarm Enable	OFF
Low Alarm Temperature	Lower limit of measurement range
Trend Curve Upper-Limit	Upper limit of measurement range
Trend Curve Lower-Limit	Lower limit of measurement range
Trend Curve Limit Mode	Auto
Trend Time Span	200 ms

Table 4: Factory Default Values

5.10.11 Log

This menu allows reviewing or deleting of previously stored temperature records. To review temperature records follow the steps given below:

1. Push the <Menu> soft key until <Log> shows as the right soft key function.

2. Push the <Log> soft key and then select the temperature record of interest (Profile, Basic, or Trend) to review it.

Additionally, pushing the <Delete> soft key allows you to remove an individual or all sets of the temperature record.

Delete All Data

To delete all of the records:

1. Push the <All> soft key.
2. At the confirmation screen, push the <Yes> soft key.

Delete Individual Data Records

To delete individual records:

1. Push the one soft key.
2. Use the down and up arrow soft keys to access the desired record.

Once the desired record is shown, push the <Yes> soft key to delete the record.

5.10.12 °C and °F

To toggle between °C (Celsius) and °F (Fahrenheit) measurements, push the <Menu> soft key until °C or °F is shown as the left soft key function. All temperature values are converted automatically. Push the corresponding soft key to change between the measurements.

5.10.13 Scope

This is used by the scope model and is not available in the standard model.

Push the <Menu> soft key until <Scope> is shown as the right soft key function. Scope can be on or off by pressing this soft key, which means the user can find an illuminated red dot when looking through the scope.

5.11 Data Download

The stored data can be downloaded to a PC with the included USB cable and the included software. See the software documentation for details. The USB input port is located on the right side of the instrument. The stored data can also be downloaded through the Bluetooth® 4.0 interface to iPhone, support for iOS 7.0 and above. After activating Bluetooth on the instrument, the user can find it on the iPhone. Use the "Raytek 3i Plus" App, which can be downloaded from the App Store (please search by its name). To monitor real-time measurement in a relative faraway place, download the Basic test data and Profile test data, take photos and send via e-mail.

Accessories

6 Accessories

Accessories include items that may be ordered at any time and added on-site:

- Carrying case (XXXR3IPLUSCC)
- Neck strap (XXXR3IPLUSSTRAP)
- CD with software for real-time graphic temperature display and data download
- Lithium-ion battery, 2.5 Ah (XXXR3IPLUSACCU)
- Mini USB port adaptor with multi-country power plug (100 – 240 VAC, 50/60 Hz), including SAA, EU, UK, US and CCC (XXXR3IPLUSPS)
- Mini USB-to-DC jack converter for charging battery separately (XXXR3IPLUSPSCON)
- Computer cable with USB-to-Mini USB, 1.5 m (4.9 ft) (XXXR3IPLUSUSBCB)

7 Windows Software

7.1 Introduction

The DataTemp® Raynger 3i Plus is the PC software application for Raynger 3i Plus series instruments. With this software, the user can perform real-time monitoring, download test data, and create profiles to optimize measurement.

DataTemp Raynger 3i Plus software features:

- Displays acquired results in graphs and tables
- Real-time monitoring while connected to a PC, and records the wave according to your needs.
- Replays saved wave and exports record list to .CSV format.
- Downloads Basic test data, Trend data, and Profile test data to PC and exports to .CSV format
- Creates new profile in PC and uploads to the instrument
- Produces final reports in .csv format, and provides standard form templates

Standard users launch DataTemp Raynger 3i Plus software. Connect the meter to the PC, and transfer data, monitor in real-time and download test data for reporting. More advanced users might spend time to define and create a profile through the PC to optimize their measurement.

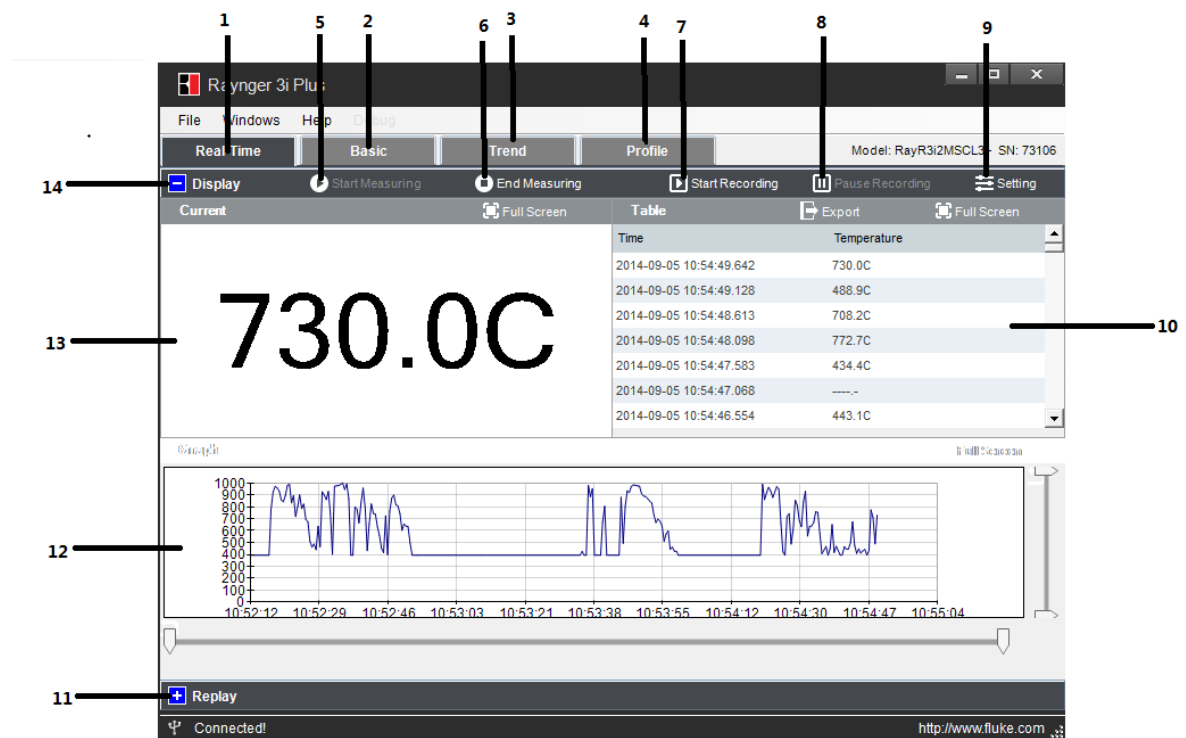

Figure 7: Main Screen

Windows Software

No.	Description
1	Real -time Monitor tab
2	Basic Test Data tab
3	Trend Test Data tab
4	Profile create, edit, upload and Profile Test Data tab
5	Start Measuring button
6	End Measuring button
7	Start Recording button
8	Pause Recording button
9	Setting button updates the instrument setting through the PC.
10	Table area shows test data in record list.
11	Replay button opens the saved wave file.
12	Graph area shows the wave in real time.
13	Current area to indicate the big size showing data
14	Display button which can real time monitor temperature change.

7.2 System Requirements

Minimum requirements for the PC:

- Operating system: Windows XP, Windows 7, Windows 8
- Communication: USB 2.0



To install DataTemp Raynger 3i Plus software you must log in with Administrator privileges!

7.3 Software Installation

From the CD, launch the executing file to install the software on a computer. Follow the installation wizard's instructions on the screen.



While installing the software, the USB driver for the instrument is installed Automatically!

7.4 Communication

To establish communication between the instrument and the PC software, follow the steps below:

Step 1: Connect the instrument to the PC via USB

Step 2: Open the <File> menu

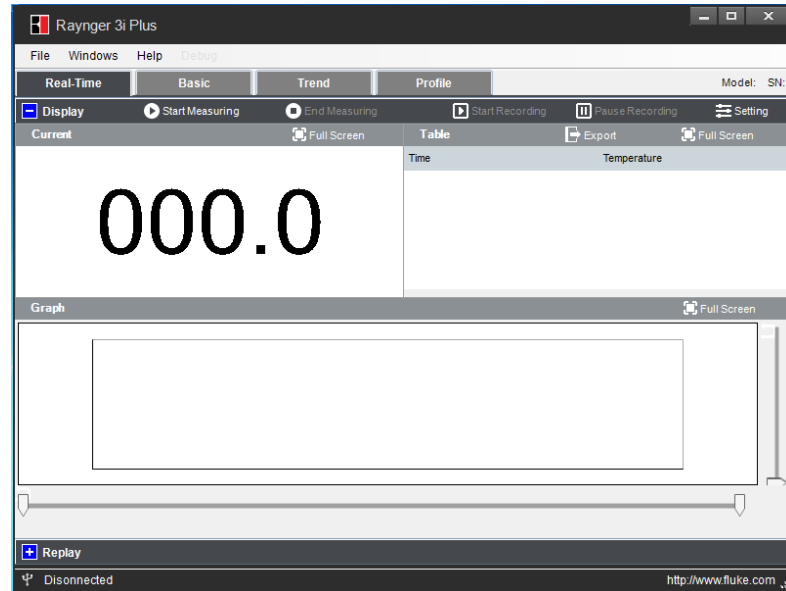

Figure 8: Open File

Step 3: Choose appropriate COM Port with Raynger 3i Plus Device and click <Connect>

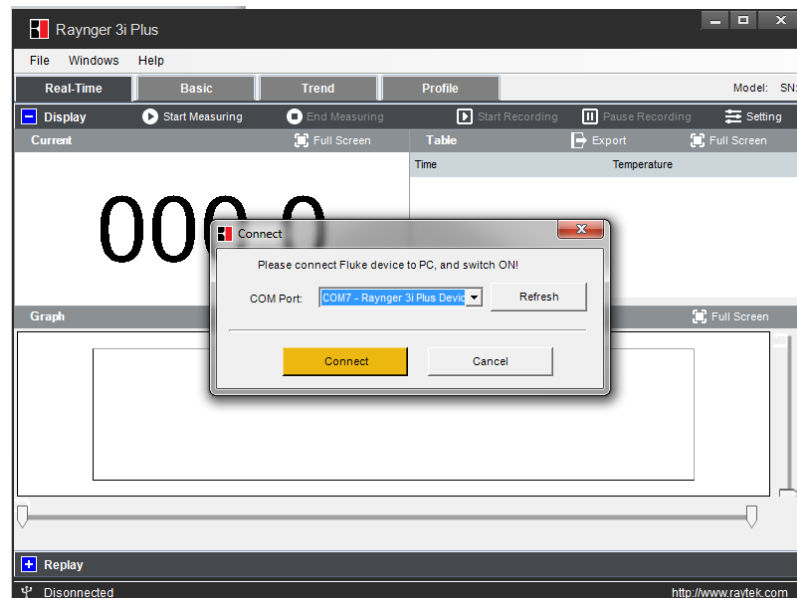

Figure 9: COM Port Selection

Windows Software



A simultaneous communication via USB and Bluetooth is not allowed!

7.5 Real-Time Data

7.5.1 Display

Under the real-time mode, the software provides multiple views. After pressing <Start Recording>, you can enter real-time monitor mode, the trigger of the instrument is locked automatically. The record list and the graph display will keep recording all test results until you press <Pause Recording>.

- Display current temperature (1)
- Record list in a table (2)
- Real-time display curve as graph (3)

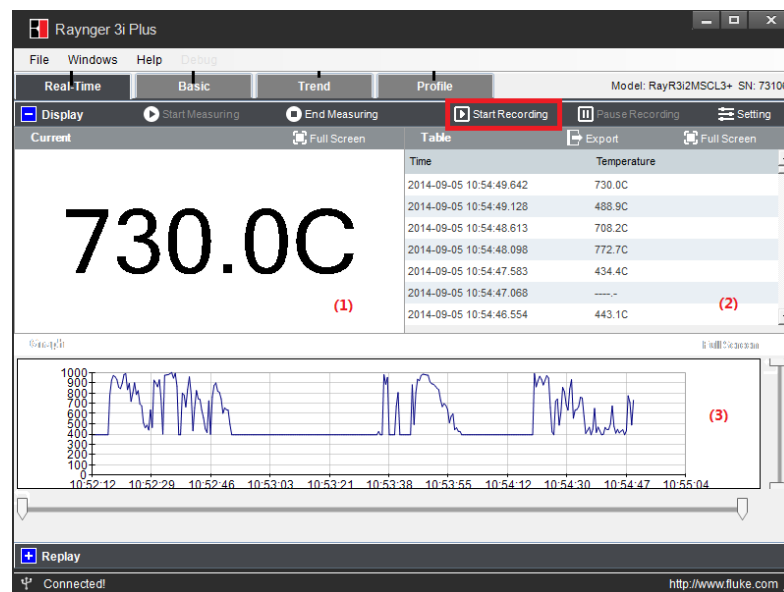

Figure 10: Display Window

7.5.2 Settings

When the instrument is connected to the PC, the software will read the instrument's setting at first and will add this information to the test report.

The user can also change these settings through the PC interface and upload to the instrument. Click on the <Setting> button to launch the corresponding dialog box.

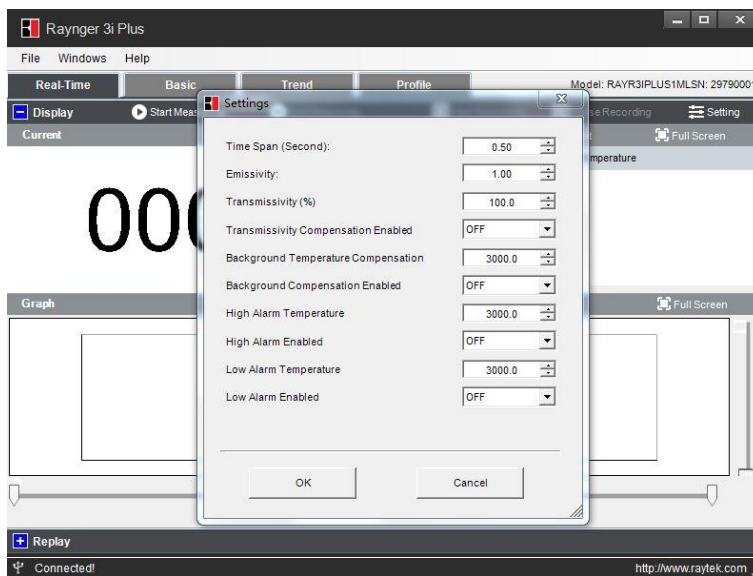

Figure 11: Settings Dialog

The user can change the following settings:

- 1 Time Span
- 2 Emissivity
- 3 Transmittance Compensation Parameters (%)
- 4 Transmittance Compensation Enabled
- 5 Background Compensation Parameters
- 6 Background Compensation Enabled
- 7 High Alarm Temperature
- 8 High Alarm Enabled
- 9 Low Alarm Temperature
- 10 Low Alarm Enabled

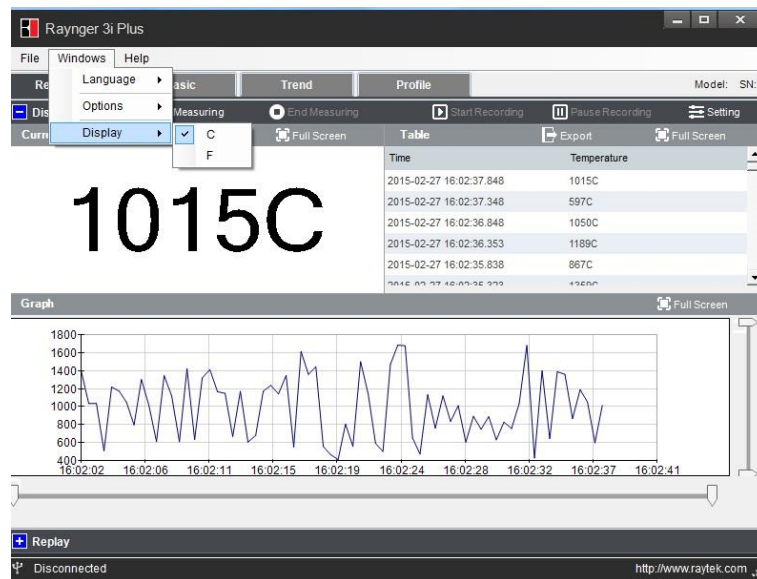

Figure 12: Changing the displayed Temperature Unit

7.5.3 Replay

The user can replay the file recorded in real-time mode, search it according to date, and open the file to review the trend change. The user can also export the saved curve into the .csv file format.

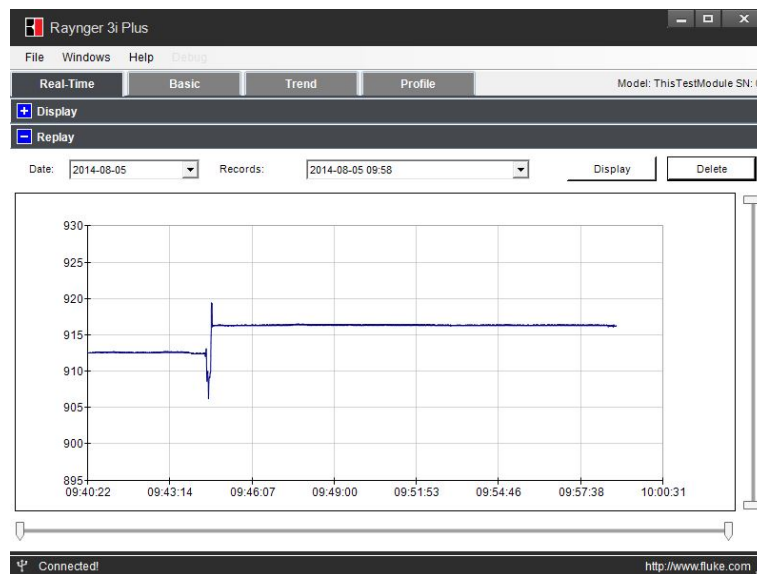

Figure 13: Replay Window

Windows Software

7.6 Recorded Data

The recorded data is divided into three groups: <Basic test data>, <Trend data>, and <Profile test data>.

- <Basic test data> is the test data without dedicated settings. The user can record random measurement data in this area with a maximum of 1,000 records.
- <Trend data> is saving data under trend mode, which should include three-screen data with 360 test values. The minimum interval for trend is 20 ms. In this mode, the user can capture instant temperature changes. This data will be saved as a curve format. The user can review the trend on the instrument, and the value of each test point by PC software. Press <View> to review the trend picture, and the up and down arrows to choose each saved trend data. The left and right arrows help in viewing the three screens for each piece of trend data.
- <Profile test data> is the test data under the profile setting, which can save a maximum of 300 records. By using the load value of each profile, these test data have been divided by group according to the profile setting in the PC software. The user can find the temperature distribution status in one group. When starting the measurements, the user can easily recall a profile instead of having the need to set each parameter individually such as emissivity or temperature alarm thresholds.

7.6.1 Basic Data

The user can import the test data under <Basic> measurement mode.

After pressing the <Download> button, the test data from the instrument will be read and appear in a bivariate table format with time, temperature, emissivity, transmittance and background compensation information.

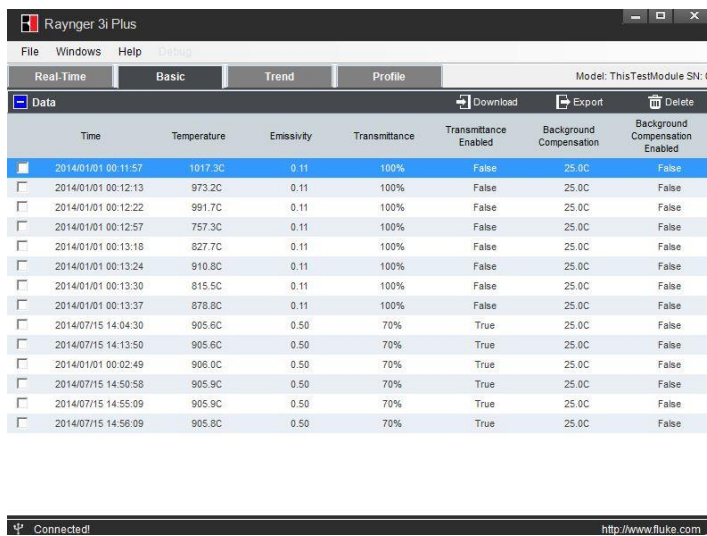

	Time	Temperature	Emissivity	Transmittance	Transmittance Enabled	Background Compensation	Background Compensation Enabled
<input checked="" type="checkbox"/>	2014/01/01 00:11:57	1017.3C	0.11	100%	False	25.0C	False
<input type="checkbox"/>	2014/01/01 00:12:13	973.2C	0.11	100%	False	25.0C	False
<input type="checkbox"/>	2014/01/01 00:12:22	991.7C	0.11	100%	False	25.0C	False
<input type="checkbox"/>	2014/01/01 00:12:57	757.3C	0.11	100%	False	25.0C	False
<input type="checkbox"/>	2014/01/01 00:13:18	827.7C	0.11	100%	False	25.0C	False
<input type="checkbox"/>	2014/01/01 00:13:24	910.8C	0.11	100%	False	25.0C	False
<input type="checkbox"/>	2014/01/01 00:13:30	815.5C	0.11	100%	False	25.0C	False
<input type="checkbox"/>	2014/01/01 00:13:37	878.8C	0.11	100%	False	25.0C	False
<input type="checkbox"/>	2014/07/15 14:04:30	905.6C	0.50	70%	True	25.0C	False
<input type="checkbox"/>	2014/07/15 14:13:50	905.6C	0.50	70%	True	25.0C	False
<input type="checkbox"/>	2014/01/01 00:02:49	908.0C	0.50	70%	True	25.0C	False
<input type="checkbox"/>	2014/07/15 14:50:58	905.9C	0.50	70%	True	25.0C	False
<input type="checkbox"/>	2014/07/15 14:55:09	905.9C	0.50	70%	True	25.0C	False
<input type="checkbox"/>	2014/07/15 14:58:09	905.8C	0.50	70%	True	25.0C	False

Figure 14: Basic Window

There is a check box with each table row, so the user can choose the data to edit or export to a test report with *. csv format.

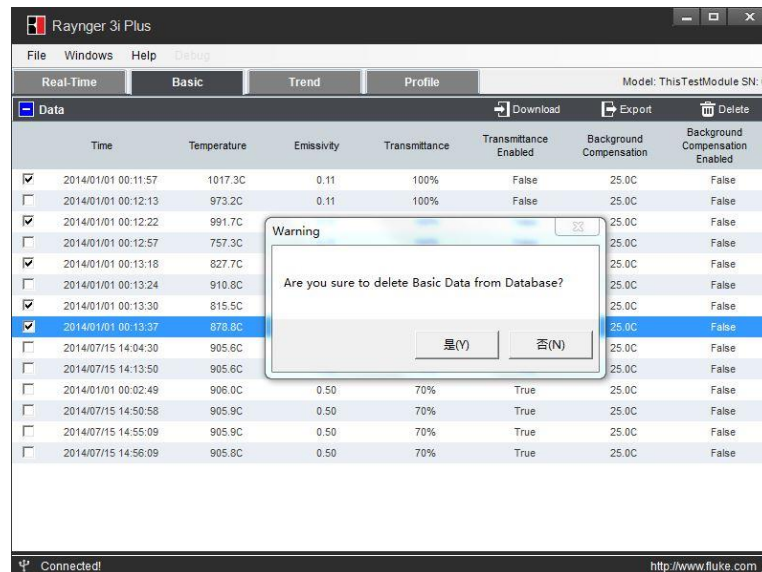

Figure 15: Data Deletion

7.6.2 Trend Data

After the user has imported the trend test data from the instrument, the data will appear in a table formatted with the point# and corresponding temperature value. There is also a graphical area to display the trend data.

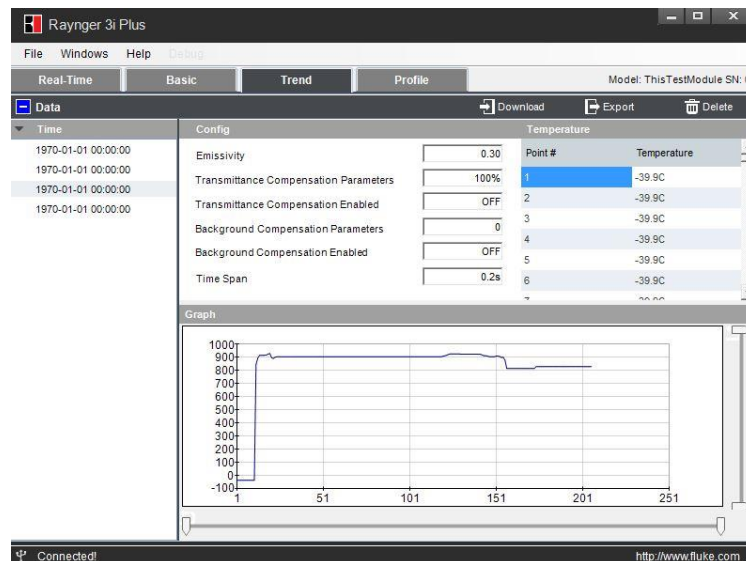

Figure 16: Trend Data

7.6.3 Profile Data

This feature provides a convenient method for the user to create settings through this function according to their use case just before the measurements. There are two locations to store the profile: <Local> and <Device>. The user can upload, edit, and create the profile under the <Local> place, and download the device profile and device test data in <Device> place.

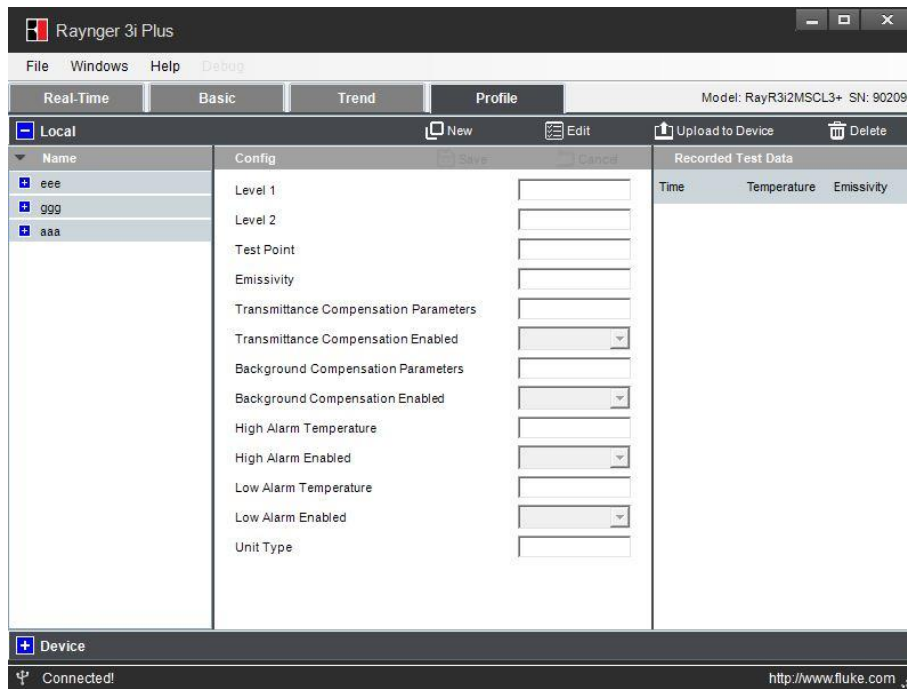

Figure 17: Profile Data

7.6.3.1 Local

Under this mode, in <Local> the user can create their own setting group with three level menus and also with EMS, transmittance compensation, background compensation, high-temperature alarm, low-temperature alarm setting, and laser and backlight enable or disable. For each profile, it will have a profile code that includes the names of the first level menu, second level menu and test point number.

For example:

1. User named the first level “qwe,” the second level “asd,” and the test point is 20 pcs.
2. After these profiles were created, the user can upload these profiles to the instrument.

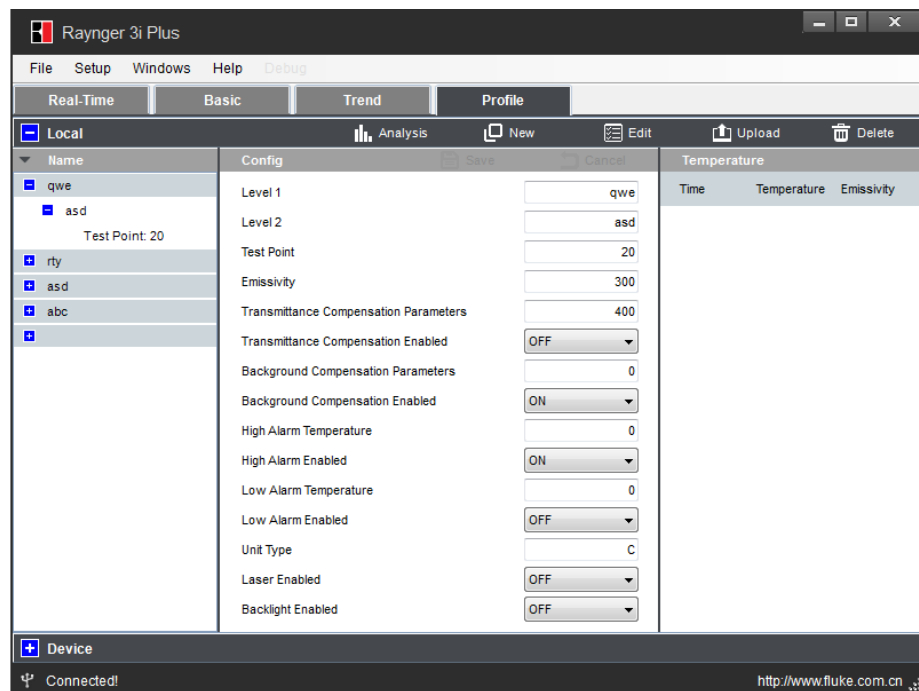
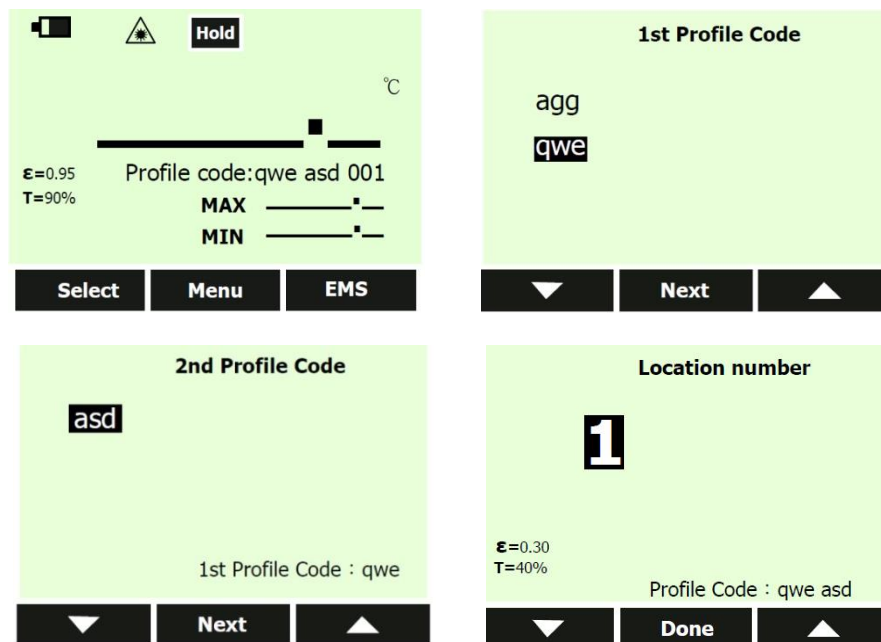

Figure 18: Local Profile

- Before measurement, the user can call up this profile in the instrument:



7.6.3.2 Device

In <Device> mode, the user can download the existing profile from the instrument to the PC. Put the mouse cursor on the 2nd level profile name, then click <Show Device Data>, afterwards all test data can be found in this place, click <Import to Local> to perform editing both the profile structure and the profile test data in <Local> place.

User can also delete the profile structure and profile test data in this place.

Windows Software

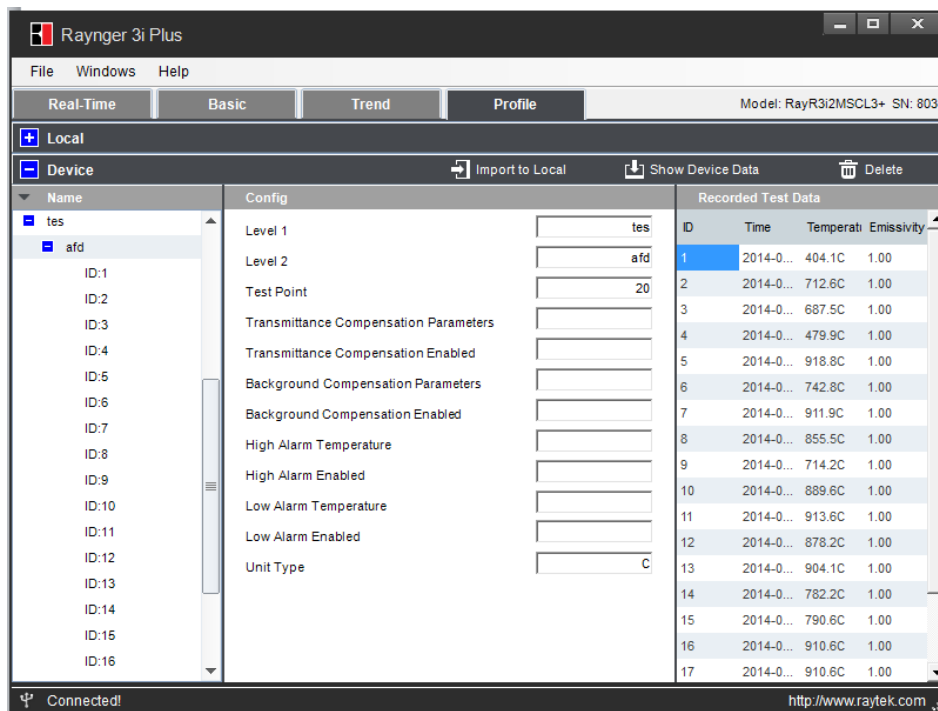

Figure 19: Device Profile

The user can also download the test data with the <Export> function into a csv format.

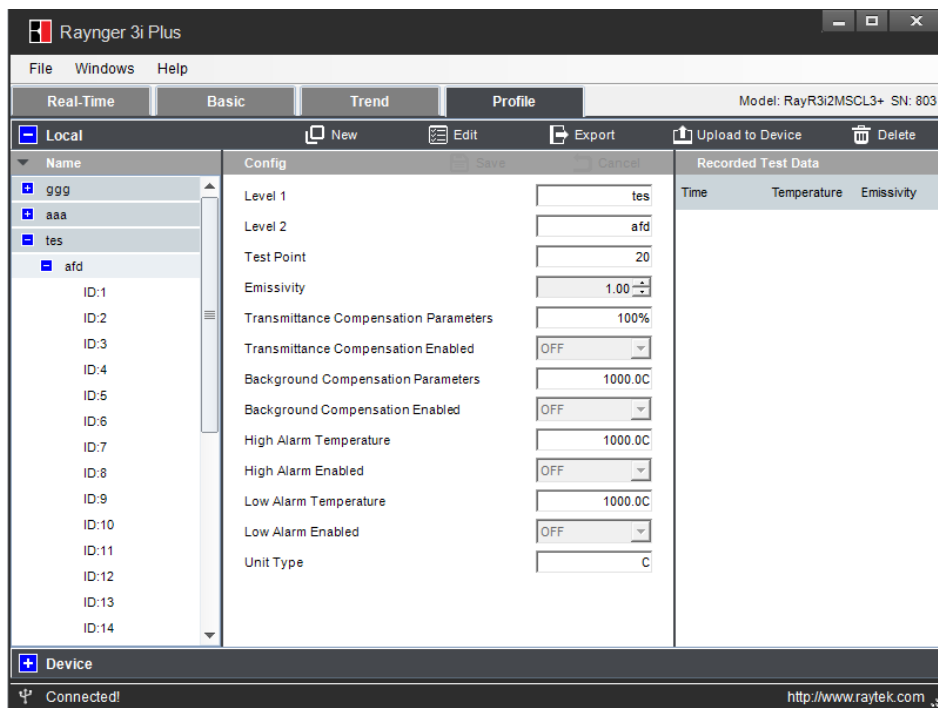

Figure 20: Export Data to the PC

Windows Software

The csv file will include the historical record of the same test points which is useful to the user to find the change rule of each point. For example, in the table below, test point 1 and test point 2 all have 5 records with different times and the data shows the temperature is stable on these days.

Profile Name Level 1	Profile Name Level 2	Test Point #	Temperature Value	Units Type	Record Time	EMS	Transmittance Compensation	Transmittance Compensation	Background Compensation	Background Compensation	High Alarm Temperature	High Alarm Enabled	Low Alarm Temperature	Low Alarm Enabled	SN
tes	afd	1	768.2	C	2014/1/10 8:20	0.1	FALSE	10%	FALSE	25.0C	2999.0C	FALSE	699.0C	FALSE	803
tes	afd	1	768.5	C	2014/2/10 9:22	0.1	FALSE	10%	FALSE	25.0C	2999.0C	FALSE	699.0C	FALSE	803
tes	afd	1	768.7	C	2014/3/10 10:25	0.1	FALSE	10%	FALSE	25.0C	2999.0C	FALSE	699.0C	FALSE	803
tes	afd	1	768.5	C	2014/4/10 8:23	0.1	FALSE	10%	FALSE	25.0C	2999.0C	FALSE	699.0C	FALSE	803
tes	afd	1	769.1	C	2014/5/10 8:22	0.1	FALSE	10%	FALSE	25.0C	2999.0C	FALSE	699.0C	FALSE	803
tes	afd	2	765.1	C	2014/1/10 9:09	0.25	FALSE	100%	FALSE	25.0C	2999.0C	FALSE	699.0C	FALSE	803
tes	afd	2	765.4	C	2014/2/10 8:54	0.25	FALSE	100%	FALSE	25.0C	2999.0C	FALSE	699.0C	FALSE	803
tes	afd	2	765.7	C	2014/3/10 8:31	0.25	FALSE	100%	FALSE	25.0C	2999.0C	FALSE	699.0C	FALSE	803
tes	afd	2	765.8	C	2014/4/10 8:39	0.25	FALSE	100%	FALSE	25.0C	2999.0C	FALSE	699.0C	FALSE	803
tes	afd	2	766.1	C	2014/5/10 8:29	0.25	FALSE	100%	FALSE	25.0C	2999.0C	FALSE	699.0C	FALSE	803

Figure 21: Exemplary Historical Record

Mobile App

8 Mobile App

The “Raytek 3i Plus” mobile app is a computer program for models having Bluetooth functionality. The app designed to run on smartphones, tablet computers and other mobile devices. The app requires the support of the iOS¹ mobile operating system 7.0 or higher.

Please download the mobile app in the App Store by searching for its name, and install the app on your mobile device.

After opening the Bluetooth switch on the instrument, the user can find the instrument on the mobile device. Use the “Raynger 3i Plus” mobile app to monitor real-time temperature changes, download Basic test data and Profile test data, and e-mail data in the .csv format.

Connecting the Instrument

Click on the <Raytek 3i Plus> icon; enter following <DataTemp Raynger 3i+> interface.

1. The APP can find the instrument automatically in the “Device” list.
2. User can change the device name to their favorite one and click the save icon, so it will be shown when this instrument is connected next time.
3. After enter the APP, there are Real time; Basic log; Profile log options on the main screen.

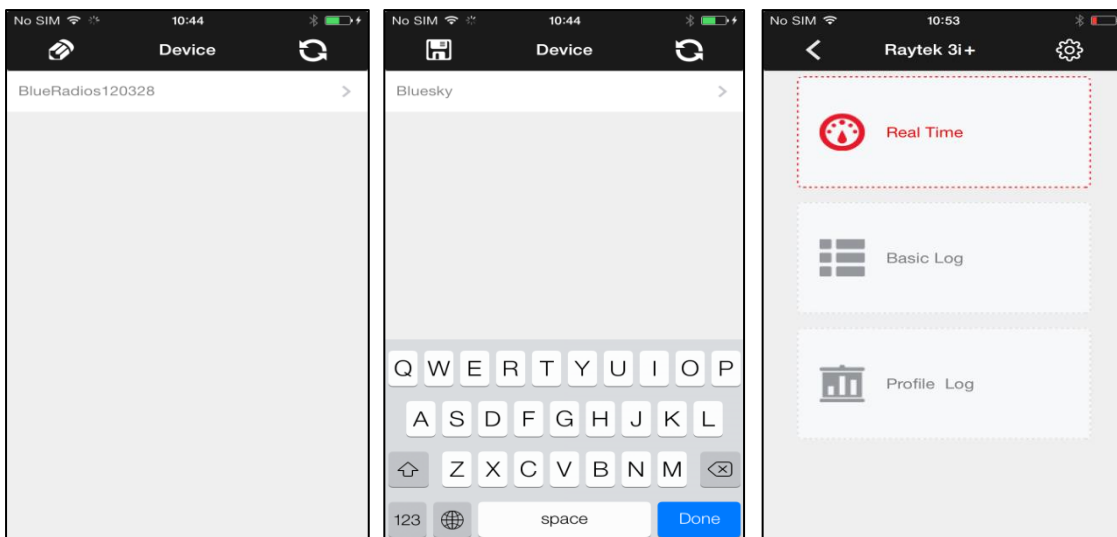

Figure 22: Main Screens

8.1 Real Time View

The click on the <Real Time> button provides the following view.

¹ iOS is a registered trademark of Apple Inc.



Figure 23: Real-Time Temperature View

By clicking on the camera  icon on the upper-right corner, the user can take a photo from the field. By clicking on the <Send> icon, the user could e-mail the photo and data.



Figure 24: Real-Time E-Mail

8.2 Basic Test Data

By clicking on the <Basic Test Data> button, the user can download the recorded Basic Data into the unit.

This place permits the user to download Basic test data in several phases (100 pcs data in one phase). So if there are plenty of test data, after the first 100 pcs has been finished download, please click the continue button on the screen to keep on downloading the remained data.

Notes:

1. The download data won't be stored in iPhone, so if user left this page and enter again, the APP will download the test data again automatically.

Mobile App

2. To ensure the download process more smooth, please do not use the unit perform testing during data download period.

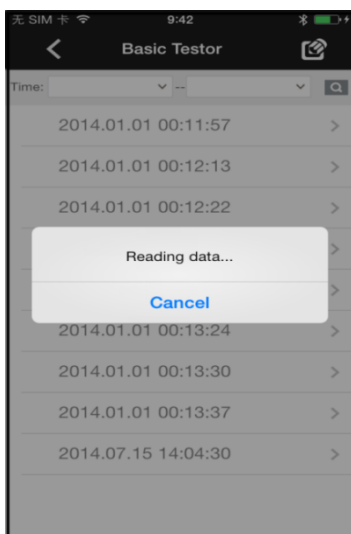

Figure 25: Basic Test Data Download

8.2.1 Data Review

After completing the download, a list of the recorded dates and times will be displayed, see left figure below.

By clicking on the desired data set, the temperature and the relative settings of the reading will be shown, see right figure below.

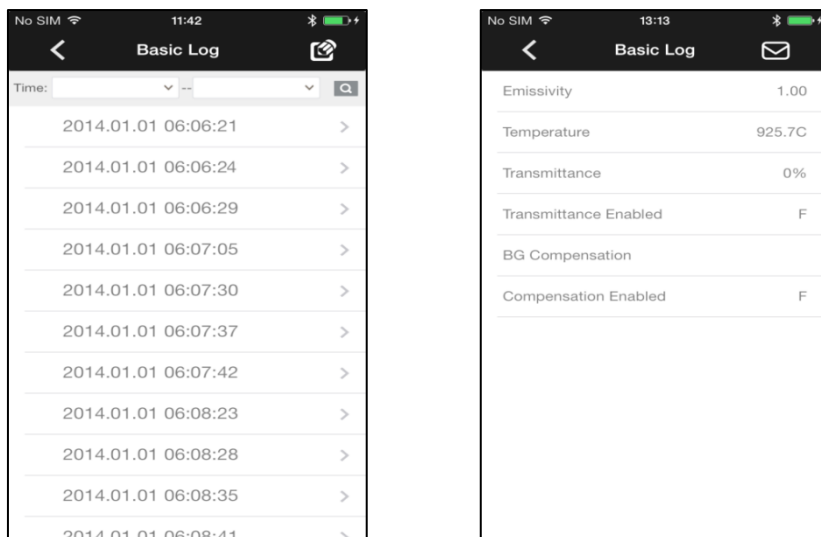



Figure 26: Basic Log

Clicking on the e-mail  icon in the upper right corner enables details to be emailed.

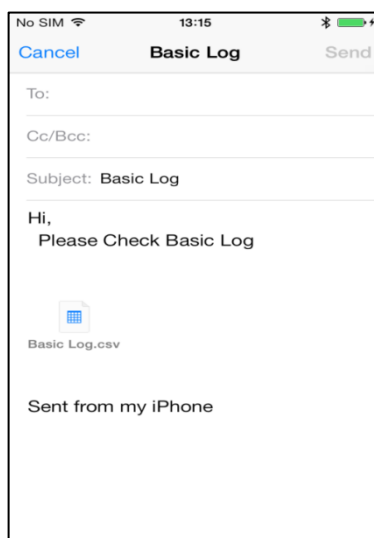

Figure 27: Basic Log E-Mail Sending

For sending multiple sets of data via e-mail, click on the to the left of the list of items, see left figure below.

By clicking the e-mail icon in the upper right corner the selected test data can be sent, see right figure below.

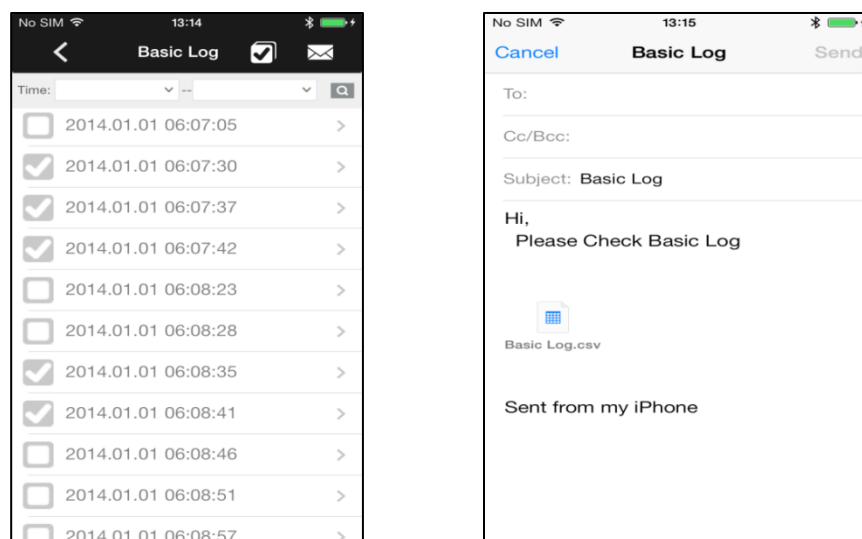

Figure 28: Basic Log – Multiple Data Sets

8.2.2 Data Review by Time

By clicking on the time input box in the upper left corner, a dialog box opens to select the starting time/data for the recorded data sets.

Mobile App

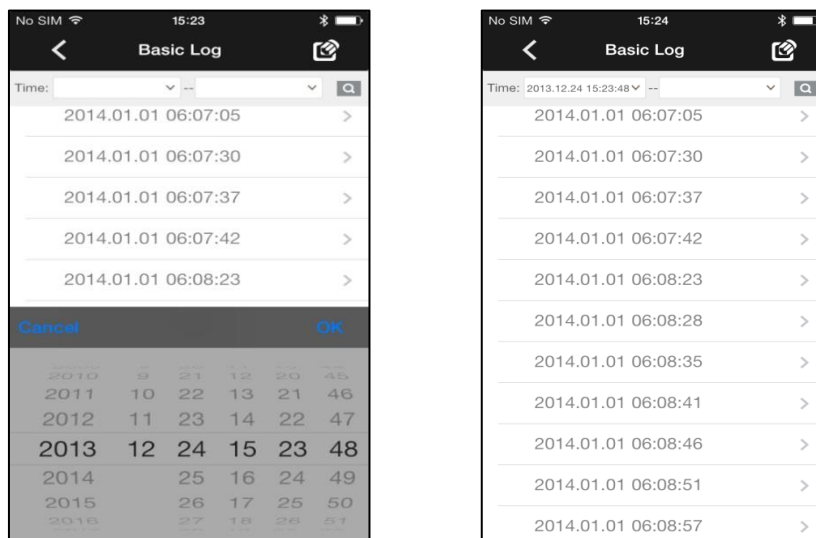

Figure 29: Basic Log – Data Sets at the desired Starting Time

By clicking on the time input box in the upper right corner, a dialog box opens to select the end time/data for the recorded data sets.

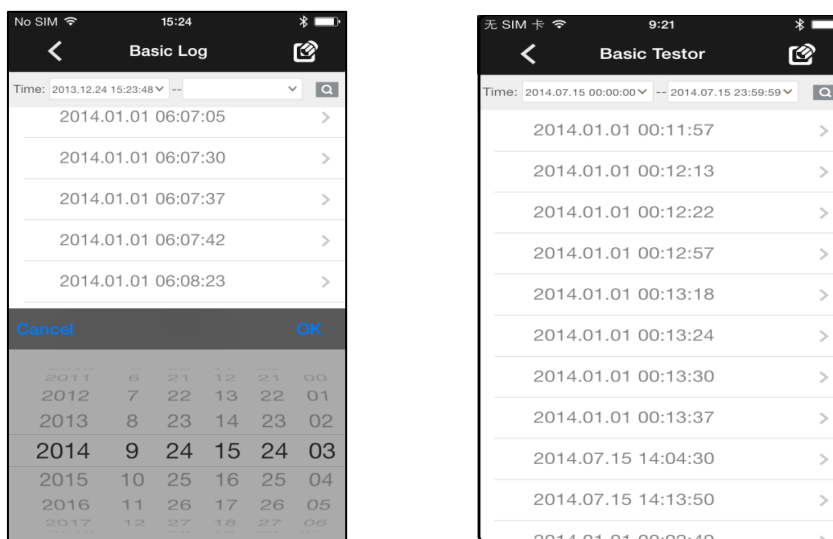

Figure 30: Basic Log – Data Sets at the desired End Time

By clicking on the <Finding> icon, the selected items will be displayed as follows:

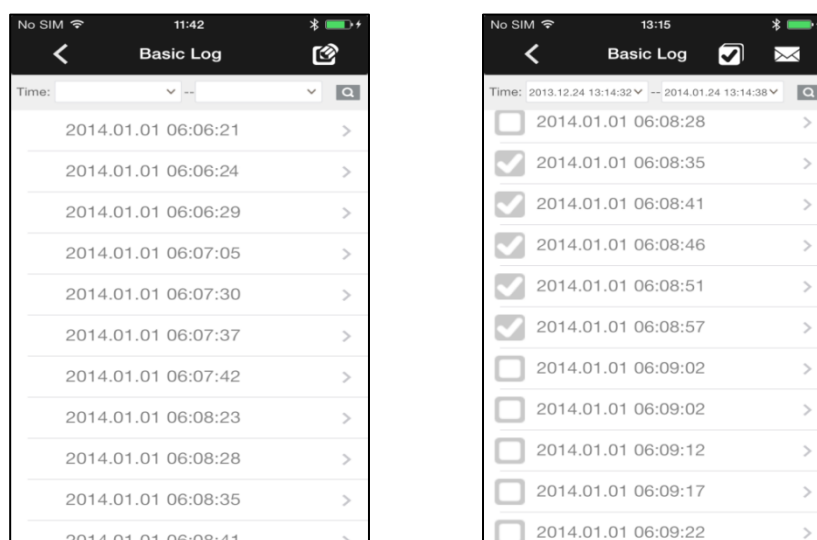



Figure 31: Basic Log Download – Selected Data Items

By clicking on the e-mail  icon in the upper right corner, the selected data can be sent by e-mail.

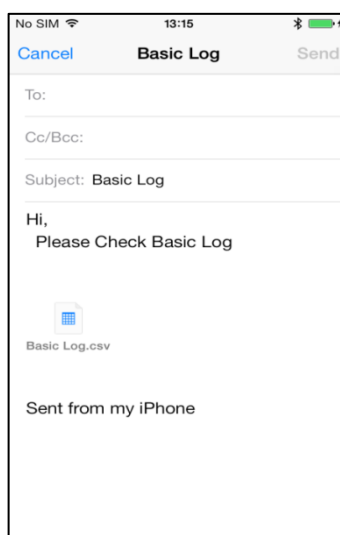

Figure 32: Basic Log Data E-Mail

8.3 Profile Test Data

By selecting the <Profile Test Data> icon, the user can download the Profile Test data from the unit. Clicking on each item provides the detail data for that group.

Note:

1. To ensure the download process more smooth, please do not use the unit perform testing during data download period.

Mobile App

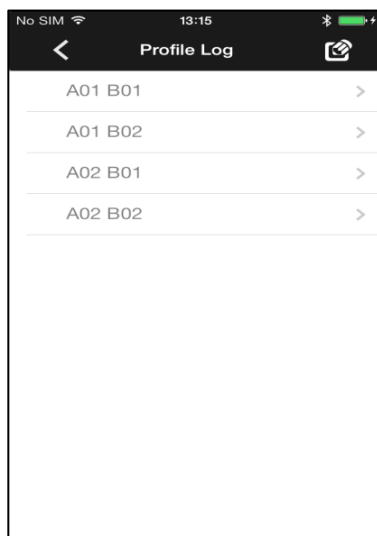

Figure 33: Profile Log Data

For sending multiple sets of data, such as <A01 B01>, click the on the left side of the list of items, see left figure below.

By clicking on the e-mail icon in the upper right corner the selected test data can be sent, see right figure below.

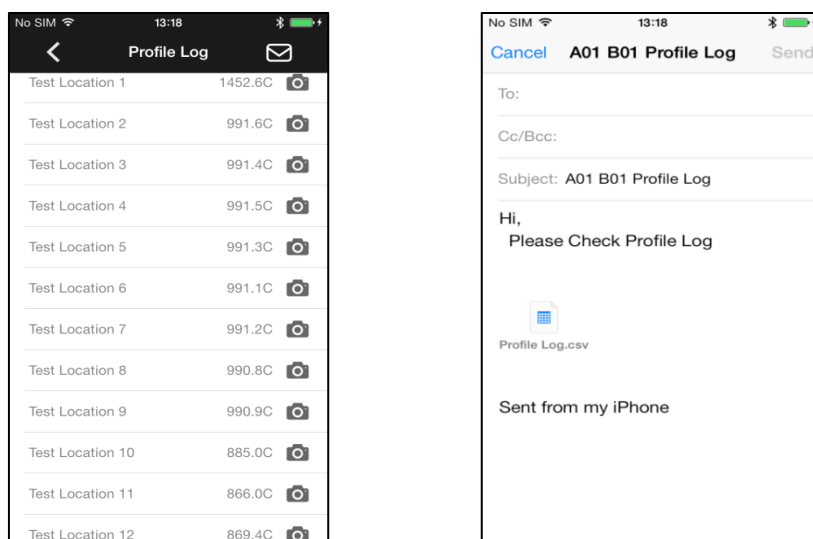

Figure 34: Profile Test Data – E-Mail Sending

By clicking on the camera icon on the upper-right corner, the user can take a photo from the field. By clicking on the e-mail icon in the upper right corner the selected test data can be sent.

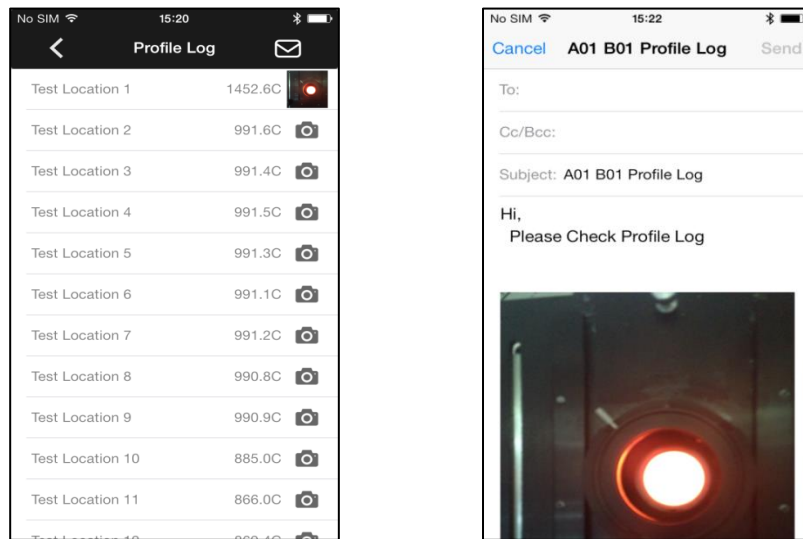

Figure 35: Profile Test Data with Photos Attached

Maintenance

9 Maintenance

Our sales and customer service representatives are always at your disposal for questions regarding applications, calibration, repair, and solutions to specific problems. Please contact your local sales representative if you need assistance. In many cases, problems can be solved over the telephone. If you need to return equipment for servicing, calibration, or repair, please contact our Service Department before shipping. Phone numbers are listed at the beginning of this document.

9.1 Troubleshooting

Symptom	Probable Cause	Solution
Erroneous Temperature	Wrong Emissivity	Correct Emissivity Setting
	Wrong Background Temperature Compensation	Correct Background Temperature Compensation Setting
	Wrong Transmittance	Correct Transmittance Setting
	Inaccurate Field of view	Adjust Field of View via Laser Indication or Scope Red Point
	Obstructed Field of View	Remove Obstruction
	Dirty Lens	Clean Lens
LCD Backlight Red and Buzzer Sounds	Nose Too Hot	Move the instrument away from the hot temperature source
	Wrong High Temperature Alarm	Correct High Temperature Alarm Setting
	Wrong Low Temperature Alarm	Correct Low Temperature Alarm Setting
Battery Symbol Blank	Insufficient Battery Level	Charge Battery
No Trigger/Button Response	Unload Battery, Disconnected USB Cable	Reload Battery
	Trigger/Button Damage	Contact After-Sale Service
No LCD Display	Battery Level is too low	Charge Battery
	Invalid Battery	Change to a new Battery
	LCD damage	Contact Service
No LCD Backlight	LCD damage	Contact Service
No Scope Red-point	Scope damage	Contact Service
No Laser	Ambient Temperature exceeds Operation Temperature range	Use it in the operation temperature range
	Laser damage	Contact Service
Unable to Charge Battery Via Cable	Wrong Cable	Use the special USB charge cable
	Battery/Cable damage	Change to a new Battery/Cable
	USB interface	Contact Service
Unable to communicate with PC Via Cable	Wrong Cable	Use the special USB cable
	Wrong PC software	Reinstall the latest PC software
	USB interface damage	Contact Service
Unable to Communicate with iPhone Via Bluetooth	Wrong iPhone software	Reinstall the latest iPhone App
	Bluetooth damage	Contact Service

Table 5: Troubleshooting

9.2 Lens Cleaning

The user should periodically clean the instrument's front window.

A dirty front window (lens) can cause temperature measurement errors. The window is fragile, and care should be taken when cleaning it to prevent scratching. Use camera lens or eye glass tissues to clean the window.

Periodic cleaning can be done by completing one or more of the following in one of the following ways:

- Blow loose particles off the front window with clean compressed air.
Note: Unfiltered compressed air, as well as user's own breath, can cause condensation on the front window, which can trap dust particles instead of removing them.
- Gently brush off particles with a soft camelhair brush.
- Thicker contaminants can be cleaned with water and a camera lens tissue.
- Fingerprints and grease can be removed either with isopropyl alcohol, Ethanol, Xylene, Acetone, or Kodak® Lens Cleaner. Apply to the front window, and wipe gently with a camera lens tissue until user see colors on the surface, then allow to air dry. Do not wipe the surface dry, as this may scratch the surface.



Do not use any ammonia, or cleaners with ammonia, bleach, acids, or strong bases. This Can cause severe damage to the front window!

9.3 Housing Cleaning

The user should periodically clean the instrument's housing.

To clean the instrument's housing, simply use soap and water or a mild commercial cleaner. Wipe with a damp sponge or soft rag. Use a soft rag to gently wipe the display.



To avoid damaging the instrument, do NOT submerge it in water. Do not use abrasive Cleaners will damage the case!

9.4 Laser Fault

If the laser (laser models only) does not operate properly, call the supplier of the instrument. DO NOT open the instrument's main housing.

Maintenance

9.5 Battery Exchange

For exchanging the battery, follow the steps given below.

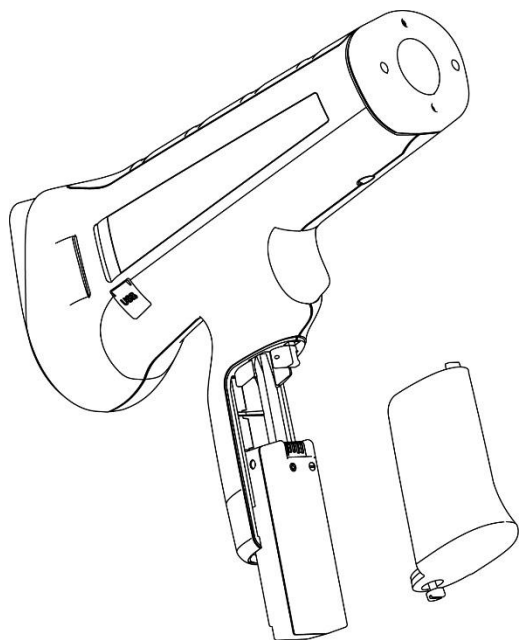

1. Unscrew the battery door.
2. Remove the battery door bolt.
3. Slide the battery along the lead rail.

Figure 36: Removing the Battery

10 Appendix

10.1 Determination of Emissivity

Emissivity is a measure of an object's ability to absorb and emit infrared energy. It can have a value between 0 and 1.0. For example, a mirror has an emissivity of 0.1, while the so-called "Blackbody" reaches an emissivity value of 1.0. If a higher than actual emissivity value is set, the output will read low, provided the target temperature is above its ambient temperature. For instance, if the set value is 0.95 and the actual emissivity is 0.9, the temperature reading will be lower than the true temperature.

An object's emissivity can be determined by one of the following methods:

1. Determine the actual temperature of the material using an RTD (PT100), a thermocouple, or any other suitable method. Next, measure the object's temperature and adjust emissivity setting until the correct temperature value is reached. This is the correct emissivity for the measured material.
2. If possible, apply flat black paint to a portion of the surface of the object. The emissivity of the paint must be above 0.98. Next, measure the temperature of the painted area using an emissivity setting of 0.98. Finally, measure the temperature of an adjacent area on the object and adjust the emissivity until the same temperature is reached. This is the correct emissivity for the measured material.

10.2 Typical Emissivity Values

The following table provides a brief reference guide for determining emissivity and can be used when one of the above methods is not practical. Emissivity values shown in the table are only approximate, since several parameters may affect the emissivity of a material. These include the following:

1. Temperature
2. Angle of measurement
3. Geometry (plane, concave, convex)
4. Thickness
5. Surface quality (polished, rough, oxidized, sandblasted)
6. Spectral range of measurement
7. Transmissivity (e.g., thin films, plastics)

Table 6: Typical Emissivity Values (Metals)

Emissivity at 1 μm for Non-Metals	
Asbestos	0.9
Ceramic	0.4
Concrete	0.65
Carbon	
Unoxidized	0.8-0.95
Graphite	0.8-0.9

Table 7: Typical Emissivity Values (Non-Metals)

Appendix

Material	Metals	
	Emissivity	
	1 μm	1.6 μm
Aluminum		
Unoxidized	0.1-0.2	0.02-0.2
Oxidized	0.4	0.4
Alloy A3003, Oxidized		0.4
Roughened	0.2-0.8	0.2-0.6
Polished	0.1-0.2	0.02-0.1
Brass		
Polished	0.1-0.3	0.01-0.05
Burnished		
Oxidized	0.6	0.6
Chromium	0.4	0.4
Oxidized		
Copper		
Polished		0.03
Roughened		0.05-0.2
Oxidized	0.2-0.8	0.2-0.9
Gold	0.3	0.01-0.1
Haynes		
Alloy	0.5-0.9	0.6-0.9
Inconel		
Oxidized	0.4-0.9	0.6-0.9
Sandblasted	0.3-0.4	0.3-0.6
polished	0.2-0.5	0.25
Iron		
Oxidized	0.4-0.8	0.5-0.8
Unoxidized	0.35	0.1-0.3
Rusted		0.6-0.9
Molten	0.35	0.4-0.6
Iron, Cast		
Oxidized	0.7-0.9	0.7-0.9
Unoxidized	0.35	0.3
Molten	0.35	0.3-0.4
Iron, Wrought		
Dull	0.9	0.9
Lead		
Polished	0.35	0.05-0.2
Rough	0.65	0.6
Oxidized		0.3-0.7
Magnesium	0.3-0.8	0.05-0.3
Mercury		0.05-0.15
Molybdenum		
Oxidized	0.5-0.9	0.4-0.9
Unoxidized	0.25-0.35	0.1-0.35

Material	Metals	
	Emissivity	
	1 μm	1.6 μm
Monel (Ni-Cu)	0.3	0.2-0.6
Oxidized		
Nickel		
Oxidized	0.8-0.9	0.4-0.7
Electrolytic	0.2-0.4	0.1-0.3
Platinum		
Black		0.95
Silver		0.02
Steel		
Cold-Rolled	0.8-0.9	0.8-0.9
Ground Sheet		
Polished Sheet	0.35	0.25
Molten	0.35	0.25-0.4
Oxidized	0.8-0.9	0.8-0.9
Stainless	0.35	0.2-0.9
Tin (Unoxidized)	0.25	0.1-0.3
Titanium		
Polished	0.5-0.75	0.3-0.5
Oxidized		0.6-0.8
Tungsten		
Polished	0.35-0.4	0.1-0.3
Zinc		
Oxidized	0.6	0.15
Polished	0.5	0.05

Table 8: Typical Emissivity Values

To optimize surface temperature measurements, consider the following guidelines:

- Determine the object emissivity using the instrument, which is also to be used for measurements.
- Avoid reflections by shielding the object from surrounding temperature sources.
- For higher temperature objects use instruments with the shortest wavelength possible.
- For translucent materials such as plastic foil or glass, ensure that the background is uniform and lower in temperature than the object.
- Hold instrument perpendicular to surface whenever emissivity is less than 0.9. In all cases, do not exceed angles more than 30 degrees from incidence.
- For 1M and 2M models, avoid measurements in high ambient light conditions.

Appendix

10.3 Compliance Standards

IEC 61010-1 Safety Requirements for Electrical Equipment for Measurement, Control, and Laboratory Use -- Part1: General Requirements

IEC 60529 Degrees of Protection Provided by Enclosures (IP Code)

EN 61326-1 Electrical Equipment for Measurement, Control and Laboratory Use – EMC Requirements --- Part1 : General Requirements

EN 61326-2-2 Electrical Equipment for Measurement, Control and Laboratory Use --EMC Requirements – Part 2-2 : Particular Requirements – Test Configurations, Operational Conditions and Performance Criteria for Portable Test, Measuring and Monitoring Equipment Used in Low-Voltage Distribution Systems

CISPR 11 Industrial, Scientific and Medical Equipment –Radio-Frequency Disturbance Characteristics –Limits and Methods of Measurement

EN 60825-1 Safety of Laser Products – Part 1 : Equipment Classification and Requirements

FDA 21 CFR 1040.10, 1040.11 with Laser Notice 50 Performance Standards for Light-Emitting Products ---Laser Products

IEC 62133 Secondary Cells and Batteries Containing Alkaline or other non-acid Electrolytes — Safety Requirements for Portable Sealed Secondary Cell, and for Batteries Made from Them, for Use in Portable Applications

UN 38.3 Recommendations on the Transport of Dangerous Goods, Manual of Test and Criteria –Lithium Batteries

EN 300328 Electromagnetic Compatibility and Radio Spectrum Matters (ERM); Wideband Transmission System; Data Transmission Equipment Operating in the 2.4 GHz ISM Band and Using Wide Band Modulation Techniques; Harmonized EN Covering Essential Requirements under Article 3.2 of the R&TTE Directive