



WIDEBAND DIGITAL LOCK-IN AMPLIFIER

LI 5655 / LI 5660

**INSTRUCTION MANUAL
(OPERATIONS)**

NF Corporation

DA00053267-005

WIDEBAND DIGITAL LOCK-IN AMPLIFIER

LI 5655 / LI 5660

**INSTRUCTION MANUAL
(OPERATIONS)**

Registered Trademarks

National Instruments and LabVIEW are registered trademarks of National Instruments Corporation in the United States.

Other company names and product names used in this instruction manual may be trademarks or registered trademarks of their respective companies.

———— Preface ————

Thank you for purchasing our "LI 5655 / LI 5660 WIDEBAND DIGITAL LOCK-IN AMPLIFIER".

Before using this device, please first read "Safety Precautions" on the following pages to use the instrument in a correct and safe manner.

■ Caution Symbols Used in This Manual

The following caution symbols are used in this manual. The instructions by these alert symbols shall be carefully obeyed to ensure equipment operator's safety, and prevent damage to equipment.

 **WARNING**

This contains information to avoid electric shock and other risks when handling the equipment that could result in the death or bodily injury of the operator.

 **CAUTION**

This contains information to avoid risks when handling the equipment that could result in minor or moderate injury of the operator or damage to property.

- The following instruction manuals are provided for LI5655 / LI5660.
 - LI5655 / LI5660 Instruction Manual (Operations)

This manual describes basic items such as how to operate the LI 5655 / LI 5660 from the panel, specifications, and maintenance.
 - LI5655 / LI5660 Instruction Manual (Remote Control)

This manual describes how to remotely control the LI5655 / LI5660.

- This manual (Operations) has the following chapters.

If using this equipment for the first time, start from Chapter 1.

 1. Outline

This chapter provides an overview and describes the features, applications, functions, and simple operation principles of this product.
 2. Preparation before Use

This chapter describes important preparation before installation and operation.
 3. Panel Operation List

This chapter shows the function and operating procedure of each panel screen part and the contents of the display screens for initial values and measurement values. Read this to get an overall understanding.
 4. Basic Operations

This chapter describes the basic operation procedures when the LI5655 / LI5660 is used as a normal single-frequency, dual-phase lock-in amplifier. Please read this chapter while operating the instrument.
 5. Advanced Operations

This chapter describes the more advanced operations as a single-frequency, dual-phase lock-in amplifier.
 6. Dual Frequency Measurement

This chapter describes the operation procedure to perform measurements with two frequencies simultaneously using two dual-phase sensitive detectors.
 7. Troubleshooting

This chapter describes how to deal with error messages and trouble.
 8. Maintenance

This chapter describes storage, repacking, and transportation as well as how to test performance.
 9. Specifications

This chapter describes the specifications (functions and performance).

Safety Precautions

To ensure safe use, be sure to observe the following warnings and cautions.

NF Corporation shall not be held liable for damages that arise from a failure to observe these warnings and cautions.

This product is a Class I device (with protective conductor terminal) that conforms to the IEC insulation standards.

- Be sure to observe the information in the instruction manual.

This instruction manual contains information for the safe operation and use of this product.

Be sure to read this information first before using this product.

All the warning items contained in this instruction manual are intended for preventing risks that may lead to serious accidents. Ensure to obey them.

- Be sure to perform grounding.

This product uses a line filter which may cause electric shock if the product is not grounded.

To prevent electrical shock accidents, connect the product to an earth ground so that ground resistance is 100 Ω or less.

This product is automatically grounded by connecting a 3-pin power plug to a power outlet with a protective ground contact.

- Check the power supply voltage.

This product operates on the power supply voltage specified in "2.3 Grounding and Connecting to Power Outlet" of this instruction manual.

Prior to connecting the power supply, check that the voltage of the power outlet matches the rated power supply of the product.

- Observe the rating of the fuse.

There is a risk of fire or other accident. Use a fuse with the rating specified in "2.3 Grounding and Connecting to Power Outlet" of this instruction manual.

Before replacing the fuse, be sure to disconnect the power cord from the outlet.

- In case of suspected anomaly

If this product emits smoke, an abnormal smell, or abnormal noise, immediately stop use and disconnect the power cord.

If such an abnormality occurs, prevent anyone from using this product until it has been repaired, and immediately report the problem to NF Corporation or one of our representatives.

- Do not use this product when gas is present.
An explosion or other such hazard may result.
- Never remove the cover.
There are high voltage parts inside this product. Never remove the cover.
Even when the inside of this product needs to be inspected, do not touch the inside. All such inspections are to be performed by service technicians designated by NF Corporation.
- Do not modify this product.
Never modify the product. Modification to the product may pose a new risk. We may refuse the repair of a modified product at fault.
- Do not expose the product to water.
Using the product while it is wet may cause electric shock or fire. If this product is exposed to water, immediately disconnect the power cord and contact NF Corporation or one of our representatives.
- If lightning occurs nearby, turn off the power switch and disconnect the power cord.
Lightning may cause electric shock, fire, or failure.
- Safety-related symbols
The general definitions of the safety symbols used on the product main unit and in the instruction manual are provided below.



Instruction manual reference symbol

This notifies the user of a potential hazard and indicates that the user must refer to the instruction manual.



Electric shock danger symbol

This symbol indicates a location that presents a risk of electric shock under specific conditions.



Warning Symbol

This contains information to avoid risks when handling the equipment that could result in the death or serious injury of the operator.



Caution

This contains information to avoid risks when handling the equipment that could result in minor or moderate injury of the operator or damage to property.

- Other symbols



Indicates the ON position of the power switch.



Indicates the OFF position of the power switch.



Indicates connected to the case.



Indicates that the outer contact of the connector is isolated from the enclosure.

However, indicates that the difference of the potential from the ground potential is restricted to 42 Vpk or less for safety (this product is used grounded so the enclosure potential and ground potential are equal).

- Electromagnetic compatibility

This product is a CISPR 11 Group 1 Class A compliant device. Do not use this product in other than an industrial area. This product may cause electromagnetic interference with other devices if used in an ordinary office or residence.

- Request about disposal

To protect the environment, please note the following guidelines for disposal of this product.

- a) This product does not contain batteries.
- b) The LCD backlight of this product does not contain mercury.
- c) Ask an industrial waste disposal contractor to dispose of this product.

Table of Contents

	Page
1. Outline	1-1
1.1 Features.....	1-2
1.2 Applications.....	1-3
1.3 Operating Principle	1-8
2. Preparation Before Use	2-1
2.1 Checking Before Use.....	2-2
2.2 Installation.....	2-4
2.3 Grounding and Connecting to Power Outlet.....	2-10
2.4 Simplified Operation Check	2-13
2.5 Calibration.....	2-14
3. Panel Operation List	3-1
3.1 Panel Part Names and Operations.....	3-3
3.2 I/O Connector.....	3-6
3.3 Overview of the Measurement Screen	3-13
3.4 Overview of the Operation Screen	3-18
3.5 Operation Tree.....	3-21
3.6 Operation Screen Reference.....	3-31
3.7 Initial Settings.....	3-62
4. Basic Operations.....	4-1
4.1 Display and Operation when Power Is Turned On	4-3
4.2 Simple Operation Procedure for Using the Device for the First Time	4-4
4.3 Measurement Parameter Setting, Output, and Display.....	4-8
4.4 Reference Signal Setting and Connection	4-11
4.5 Input Connector Setting and Connection	4-15
4.6 Time Constant Filter Setting and Characteristics	4-23
4.7 Sensitivity and Dynamic Reserve Setting.....	4-28
4.8 Phase Adjustment.....	4-33
5. Advanced Operations	5-1
5.1 Measured Value Offset and Expansion	5-3
5.2 Line Frequency Noise Removal	5-5
5.3 Harmonic Measurement (Harmonic, Subharmonic, Fractional Harmonic)	5-6
5.4 External 10 MHz Synchronization	5-7
5.5 Arithmetic Processing (Normalize and Ratio).....	5-8
5.6 Noise Density Measurement	5-12

Table of Contents

5.7	PSD Input Offset Adjustment.....	5-15
5.8	DC Voltage Measurement (AUX IN).....	5-17
5.9	DC Voltage Output (AUX OUT)	5-19
5.10	Supplying Power to the Preamplifier	5-20
5.11	Setting Memory.....	5-21
5.12	Other Functions	5-23
6.	Dual Frequency Measurement.....	6-1
6.1	Overview of the Dual Frequency Measurement.....	6-3
6.2	Detection Mode Setting	6-7
6.3	Measurement Parameter Setting, Output, and Display (Dual frequency Measurement)	6-8
6.4	Frequency Setting of the Internal Oscillator (Dual Frequency Measurement).....	6-10
6.5	Time Constant Filter Setting (Dual Frequency Measurement).....	6-11
6.6	Sensitivity Setting (Dual Frequency Measurement)	6-12
6.7	Phase Adjustment (Dual Frequency Measurement)	6-12
6.8	Measured Value Offset and Expansion (Dual Frequency Measurement).....	6-13
6.9	Ratio Measurement (Dual Frequency Measurement)	6-14
7.	Troubleshooting	7-1
7.1	Error Message	7-2
7.2	Troubleshooting	7-6
7.3	Q & A.....	7-7
8.	Maintenance	8-1
8.1	Preface.....	8-2
8.2	Daily Maintenance	8-3
8.3	Storage, Repacking, and Transportation	8-3
8.4	Version Confirmation	8-4
8.5	Main Function Confirmation.....	8-5
8.6	Performance Test.....	8-6
8.7	Calibration.....	8-28
8.8	Maintenance Information	8-29
9.	Specification.....	9-1
9.1	Measured signal system.....	9-2
9.2	Phase Sensitive Detector Section	9-7
9.3	Reference Signal System	9-11
9.4	Arithmetic Processing	9-15
9.5	Measured Value Output and Display Section.....	9-17
9.6	Monitor Output	9-18
9.7	Auxiliary Input (DC Voltage Measurement)	9-19

Table of Contents

9.8 Auxiliary Output (DC Voltage Output).....	9-19
9.9 Automatic Setting Items.....	9-19
9.10 Data Memory	9-20
9.11 Remote Control Interface	9-21
9.12 General Specifications	9-22
9.13 External Dimensions Diagram	9-23

Figures and Tables

	Page
Figure 1-1 Basic Principle of a Lock-in Amplifier.....	1-8
Figure 1-2 LI 5655 / LI 5660 Block Diagram	1-9
Figure 2-1 Rack Mount Kit Assembly Drawing (JIS)	2-6
Figure 2-2 Rack Mount Kit Assembly Drawing (EIA)	2-7
Figure 2-3 Rack Mount Dimensions (JIS)	2-8
Figure 2-4 Rack Mount Dimensions (EIA).....	2-9
Figure 2-5 Power Voltage Selector Switch.....	2-10
Figure 2-6 Fuse Replacement.....	2-12
Figure 3-1 Front Panel	3-3
Figure 3-2 Rear Panel	3-4
Figure 4-1 Noise Figure (Supplementary Values).....	4-16
Figure 4-2 CMRR (Supplementary Values).....	4-17
Figure 4-3 I Input Frequency Characteristics (Supplementary Values)	4-19
Figure 4-4 I Input Referred Noise Density (Supplementary Values).....	4-19
Figure 5-1 Line Filter Characteristics	5-5
Figure 5-2 10 MHz Synchronous System Example	5-7
Figure 5-3 Ratio Measurement Application Example (Dual Beam Method)	5-10
Figure 5-4 Noise Measurement and Bandwidth.....	5-14
Figure 9-1 LI5655 External Dimensions Diagram.....	9-23
Figure 9-2 LI5660 External Dimensions Diagram.....	9-24
Figure 9-3 LI5655 Panel Diagram.....	9-25
Figure 9-4 LI5660 Panel Diagram.....	9-26
Table 2-1 Composition List	2-2
Table 3-1 Setting Items and Initial Values	3-63
Table 7-1 In case of suspected anomaly.....	7-6

(Blank)

1. Outline

1.1 Features	1-2
1.2 Applications	1-3
1.3 Operating Principle.....	1-8
1.3.1 Basic Principle of a Lock-in Amplifier.....	1-8
1.3.2 Block Diagram.....	1-9

1.1 Features

The "LI5655 / LI5660 WIDEBAND DIGITAL LOCK-IN AMPLIFIER" is a dual-phase, dual frequency lock-in amplifier with a frequency range of 0.5 Hz to 11 MHz. (with the LI5655, 0.5 Hz to 3 MHz)

It can be widely used to measure the magnitude and phase of a small AC signal buried in noise, taking advantage of the following features.

For details on the basic functions and terms of a lock-in amplifier, see "1.3 Operating Principle"

- **Wideband**

A signal of up to 3 MHz of voltage input can be measured. With the LI5660, up to 11 MHz can be used by using a special input connector (HF) (there are some functional restrictions).

The -3 dB bandwidth for current input is 1 MHz (nominal value when signal source capacity + connection cable capacity = 150 pF).

- **Variety of Reference Signals**

In addition to a synchronous function with general external reference signals, internal oscillation signals, and measured signals without a reference signal, a signal can be synchronized with the frequency reference of other devices using an external 10 MHz (10 MHz IN connector).

- **Variety of Detection Functions**

In addition to general harmonic measurement, the following functions are provided.

- a) **Fractional Harmonic Measurement**

In addition to the harmonic, a frequency of a submultiple of the fundamental wave ($\times 1 / 1$ to $63 / 63$) can be measured.

- b) **Dual Frequency Simultaneous Measurement**

Two sets of dual phase sensitive detectors enable two frequency components included in a single input signal to be measured simultaneously. Two-component ratio arithmetic processing (RATIO) and cascade-connection of detectors are also possible.

- **Digital Processing Ensures High Stability and Superior Dynamic Reserve**

Phase detection and subsequent processing are performed digitally. Output zero drift at high gains is smaller than the analog system, and up to 100 dB dynamic reserve can be obtained (measurement can be performed with a noise 100 000 times larger than the sensitivity, namely the signal full scale).

- **High-speed Smooth Output Response**

The maximum update rate is approximately 1.5 M samples/s, and the amplitude resolution is 16 bits.

- **High-speed Locking Even at Low Frequencies**

It takes just about two cycles to lock on to the reference signal even at low frequencies. Furthermore, a moving average filter synchronized with the signal cycle obtains a high-speed response with a small ripple.

- **10 Vrms Signal Input (LI5660 Only)**

A signal of up to 10 Vrms can be measured (C connector). A large signal output of an external preamplifier can also be input.

- **Remote Control**

USB, GPIB, RS-232, and LAN are available, which facilitate incorporation into automatic measurement systems. The maximum transfer rate of measured values is 100 k samples/s (USB).

- **Thin Design**

The height is 88 mm (2U) so it can easily be mounted in a rack.

1.2 Applications

The LI 5655 / LI 5660 can be used in the following fields, taking advantage of its features.

- Scanning probe microscope signal detection
- Spectroscopy (material science using Auger electron spectroscopy, photoacoustic spectroscopy, Raman spectroscopy, etc.)
- Measurement of optical properties (intensity, absorption, scattering, transmission, etc.)
- Optical application measurements (optical gyro, detection of distance, speed, vibration, etc.)
- Magnetic measurements (evaluation of magnetic materials, vibration-type magnetometer, magnetic detection using SQUID)
- Hall coefficient measurement
- Evaluation of various sensors (measurements of physical quantities detected by optical, magnetic, and piezoelectric elements, chemical changes, etc.)
- Null detection with impedance bridge
- Impedance measurements (minute impedance, minute capacity, chemical impedance)
- Thermal diffusivity measurement of thin film materials

■ Typical Application Examples of the Phase Sensitive Detector

The following measurements can be performed using the phase detection feature in order to detect specific phase components.

a) Position Detection Using a Differential Transformer

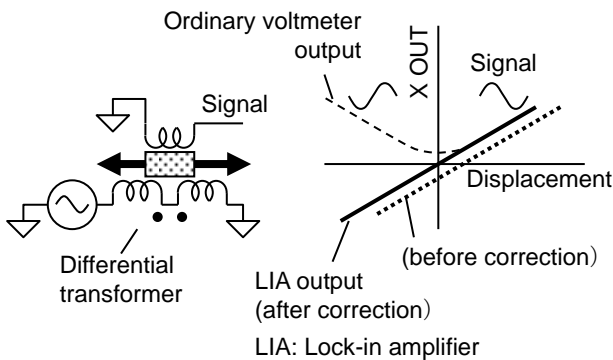

Good linearity bidirectional position detection can be performed using phase detection. This is also suitable for position feedback control.

An ordinary voltmeter cannot identify the direction, and the linearity near the zero point deteriorates due to mixing of noise or crosstalk.

A lock-in amplifier provides good linearity and it is easy to correct a zero-point error.

b) Spectral Characteristic Curve Peak Detection

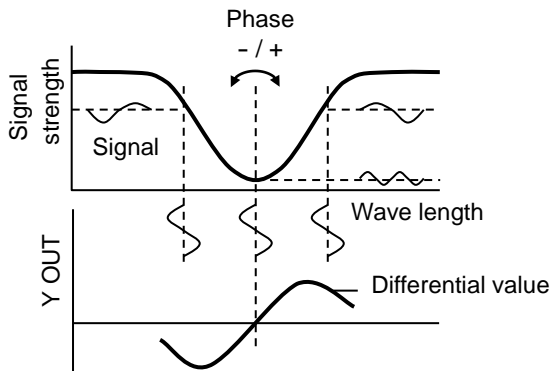

If a minute "change" is superimposed on the wavelength sweeping and the "change" of the signal strength is measured using a lock-in amplifier, the differential value of the characteristic curve can be obtained. This value goes through zero at the peak or bottom of the characteristic curve (a positive/negative inversion occurs), so it is easy to obtain that position.

Since the deviation direction can be identified, it can be used for automatic control to follow the peak wavelength.

■ Application Examples Taking Advantage of the Features of the LI5655 / LI5660

The following measurements can be performed using a variety of functions of the LI5655 / LI5660.

a) Hall Coefficient Measurement (Difference Frequency Signal Measurement)

The hall voltage is proportional to the product of two signals (current and magnetic field), and its frequency is the difference frequency (and sum) frequency of the two signals. Synchronizing an external signal, which generates a current and magnetic field, with the LI5655 / LI5660 at an external 10 MHz allows measurement of the difference frequency signal of any two frequencies without having to arrange an external reference signal (difference frequency).

To avoid the intermodulation in the LI5655 / LI5660, sufficiently suppress the original f_1 and f_2 components included in the input.

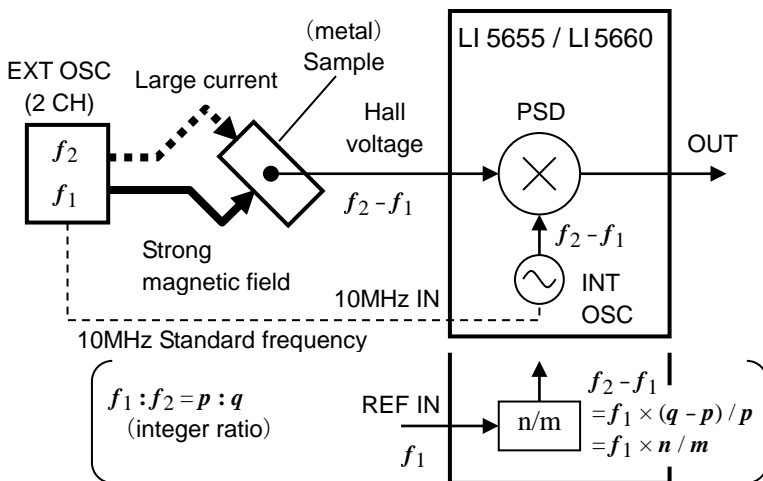

If the original frequency is an integer ratio, the difference frequency signal can also be measured using the fractional harmonic measurement function. Both can avoid a crosstalk interference from the external reference signal.

b) Measurement of Light Transmission and Absorption, and Suppression of Illuminant Fluctuation

Using both the simultaneous dual-frequency measurement and fractional harmonic measurement functions allows fluctuation corrections of light sources and other sources using the dual beam method (ratio measurement) with a single LI 5655 / LI 5660.

Applying negative feedback to the reference cell signal also stabilizes the strength of the light source.

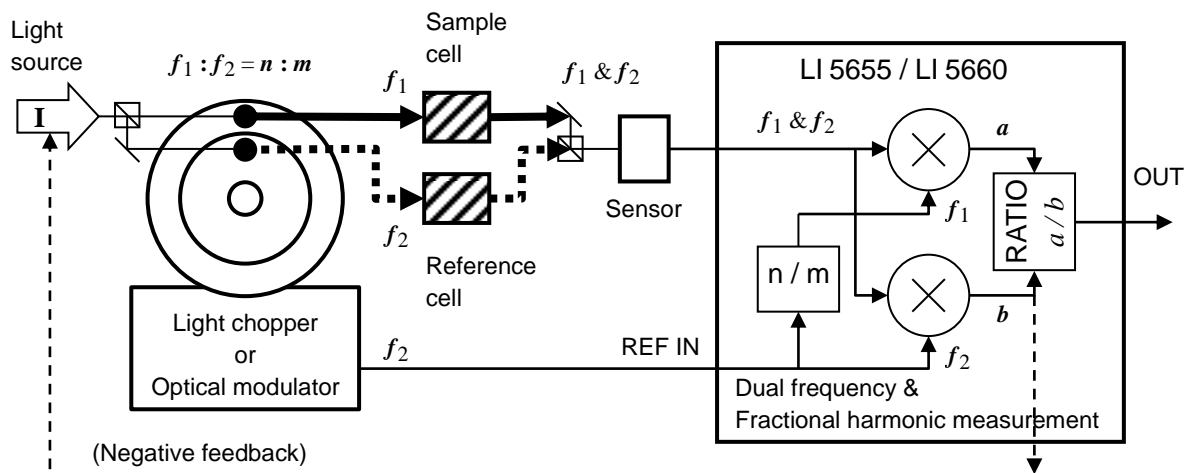

To avoid mutual interference, avoid two frequencies from being in a relationship of harmonic and subharmonic. Modulation and detection are also possible by two arbitrary frequencies by synchronizing with an external signal generator using the 10 MHz synchronization function.

c) Dual Demodulation

If the pump light and probe light are modulated at different frequencies or a sample is excited with two pump lights with different modulation frequencies, an amplitude modulation signal is obtained from the sensor and information may be included in this envelope. The LI 5655 / LI 5660 can demodulate an amplitude modulated signal and then detect the obtained envelope signal by internally cascade connecting the two detectors. The LI 5655 / LI 5660 can demodulate an amplitude modulated signal and then detect the obtained envelope signal by internally cascade connecting the two detectors.

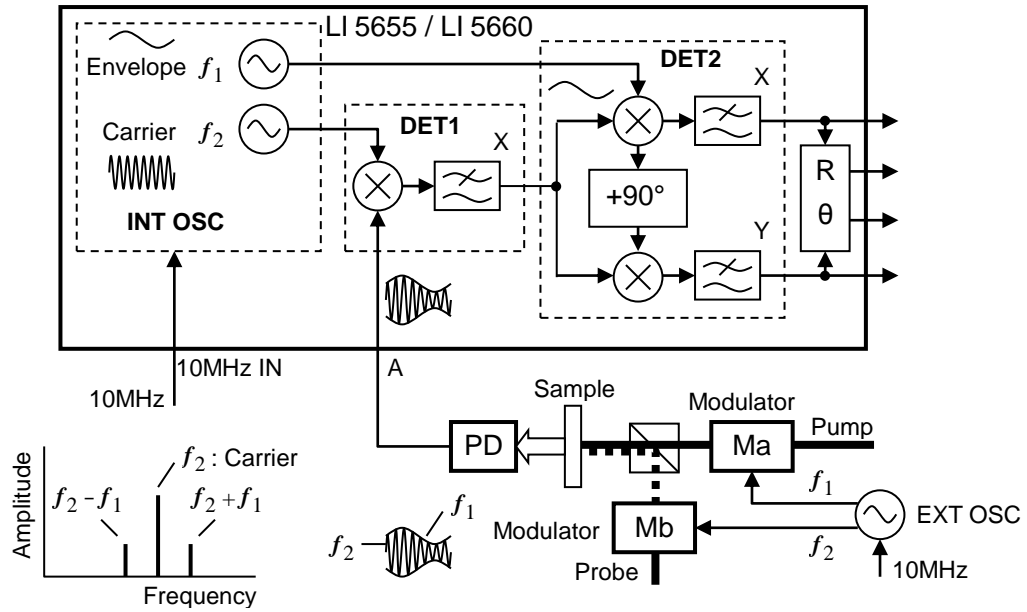

Envelope information can be obtained by detecting the amplitude modulation signal.

d) High Frequency Detector (for the LI5660 Only)

Transient Absorption (TA) and Simulated Raman Scattering (SRS) use a laser light modulated at a high frequency (10 MHz or more) in order to avoid semiconductor laser noise and increase the speed. When the HF connector and 10 MHz synchronization function are used, measurement can be performed without receiving interference from an external reference signal. If the HF connector is used, install a band pass filter (BPF) or tuning amplifier at the front in order to reduce noise outside of the measurement band (>11 MHz) of the LI5660.

If the frequency is selected properly and a moving average filter (SYNC) is used, a high-speed response can be obtained.

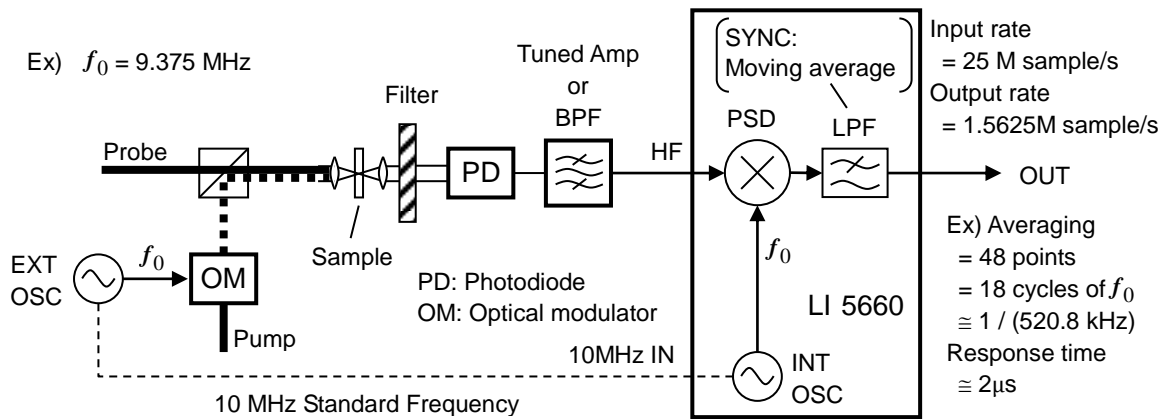

1.3 Operating Principle

1.3.1 Basic Principle of a Lock-in Amplifier

In general, noise is distributed over a wide range of frequencies. A lock-in amplifier is a device that uses the difference of the frequencies to separate signal and noise and amplify the signal. It works as a narrow band pass filter / tuning amplifier where the center frequency equivalently follows the signal.

The frequency of a signal including noise is first converted to a DC voltage using a Phase Sensitive Detector (PSD). At this point, noise in the vicinity of the signal frequency is also converted to the vicinity of DC. Then, the noise and ripple caused by detection are removed using a low pass filter (LPF) to obtain the DC component. When this is returned to the original frequency, the equivalent bandwidth is equal to the band pass filter (BPF) that is double the cutoff frequency (f_c) of the LPF. Increasing the time constant (response time) and attenuation slope (number of steps) of the filter decreases the f_c , so more noise can be removed. After the noise is removed using the LPF, a signal can be amplified without being saturated by the noise. AC gain before phase detection and DC gain after it are determined by the sensitivity and dynamic reserve (DR) settings. (DR = maximum allowable noise level / full-scale sensitivity)

A lock-in amplifier needs a reference signal (REF IN) as the reference of the frequency and phase.

The PSD is a multiplier of a measured signal and reference signal (both are a sine wave and the same frequency). The amplitude of a reference signal applied to the PSD is constant, and the phase can be shifted. The PSD output is dependent on the magnitude of the measured value (R) and the phase difference from the reference signal (θ).

A dual-phase lock-in amplifier is equipped with two PSDs, and works as a vector voltmeter that can obtain two orthogonal components X and Y (in other words, R and θ) simultaneously. If the phase of the reference signal applied to the PSD is adjusted so that Y is zero, and the magnitude of the signal is measured using X, the influence of random noise can be reduced more than with measurement using the R output.

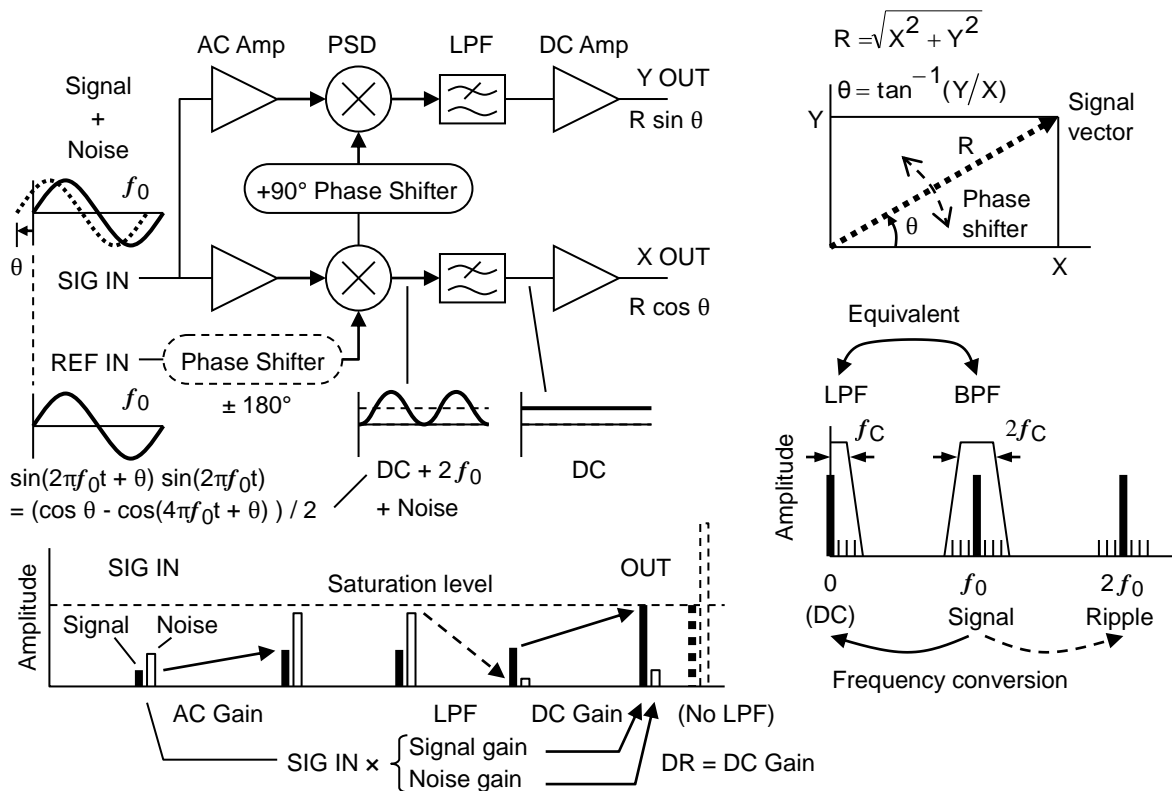

Figure 1-1 Basic Principle of a Lock-in Amplifier

1.3.2 Block Diagram

The following shows a schematic block diagram of the LI5655 / LI5660 and describes the main functions.

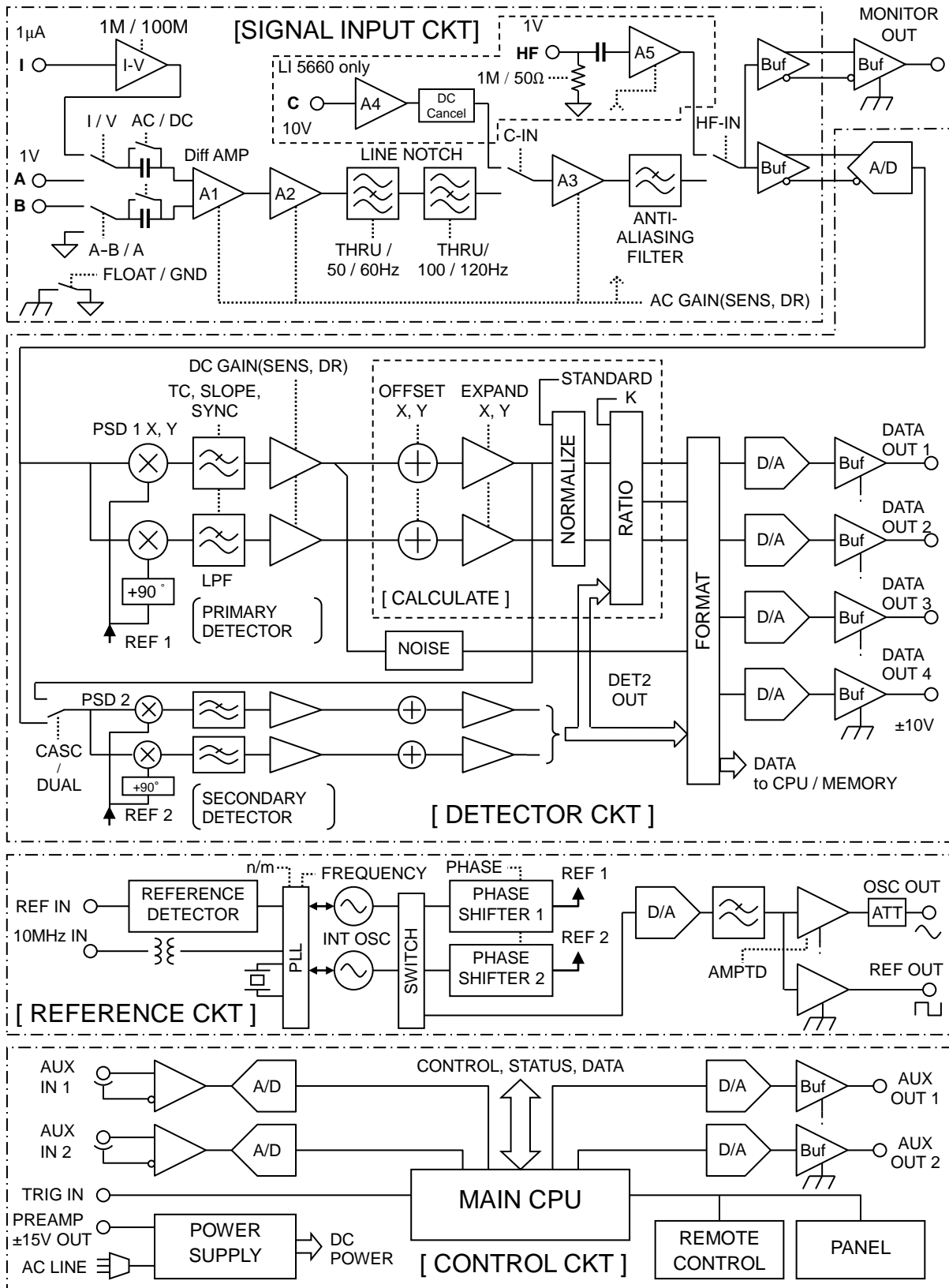

Figure 1-2 LI5655 / LI5660 Block Diagram

a) Signal Input Section (SIGNAL INPUT CKT)

The signal input section has the following functions. (Only the LI 5660 is equipped with the C and HF connectors)

Input connector selection (A, A-B, C, I, HF)

Input coupling selection (AC, DC)

Signal amplification (AC amplification)

Power line frequency noise removal (LINE NOTCH)

Anti-aliasing filter (ANTI-ALIASING FILTER)

Prevents noise outside of the band from aliasing into the signal band by means of sampling.

If the HF connector is used, the filter must be installed at the front to suppress noise outside of the measurement band, because the signal does not pass through the anti-aliasing filter.

b) Detector (DETECTOR CKT)

Sampling

An input signal is converted to a 16-bit digital signal at a sampling rate of 25 M samples/s. Although omitted in the figure, a dither signal (a sort of noise) for distributing the quantization noise is added to increase the number of effective bits for the narrow band signal.

Phase Sensitive Detection (PSD)

The frequency of a signal is converted to a DC voltage using a Phase Sensitive Detector (PSD).

Information of the magnitude and phase of a signal are saved by detecting them using two orthogonal phases. Phase sensitive detection is accomplished by multiplexing an input signal and internal reference signal. Since a reference signal applied to the PSD is a sine wave, there is no influence of the harmonic of an input signal, which becomes a problem when a simple square wave reference signal is used. A ripple doubling the signal frequency occurs in the product of a measured signal and reference signal, and the same ripple as with the signal frequency occurs in the product of an input DC offset and reference signal, but they are removed by a time constant filter in the next step. A lock-in amplifier only measures AC signals so it has the advantage that it is not affected by the thermal electromotive force (DC).

Time Constant Filter (TC, SLOPE, SYNC)

The time constant filter removes the noise and ripple caused by detection. Normally, the time constant filter consists of a 1st order low pass filter (LPF) and 1 to 4 steps (attenuation slope 6 / 12 / 18 / 24 dB/oct equivalent) that are cascade connected. Increasing the time constant (TC) and attenuation slope (SLOPE) narrows the bandwidth to remove more noise, but slows the output response. Switching the time constant filter operation to the synchronous filter (SYNC, moving average of the integer cycle) significantly reduces the ripple in the detection output, so it is easy to obtain a high-speed response by applying a small time constant value.

Amplification (DC GAIN)

When noise is removed, a signal can be amplified without being saturated by the noise. AC gain before phase detection and DC gain after it are determined by the sensitivity and dynamic reserve. The phase sensitive detector, time constant filter, and DC signal amplifier use digital operations, so there is no limit to the dynamic reserve caused by DC drift, which becomes a problem in the analog method.

Dual Frequency Simultaneous Measurement (PSD1, PSD2)

The LI5655 / LI5660 is equipped with two dual-phase Primary and Secondary PSDs. Measurements can be performed simultaneously at two frequencies. The two detectors can also be used by cascade connecting them.

c) Calculate Section (CALCULATE / FORMAT)

Measured values X and Y of the lock-in amplifier are the RMS values of orthogonal phase components.

R calculated from X and Y is the RMS value of a signal (sine wave).

The output offset adjustment (OFFSET), expansion (EXPAND), normalize arithmetic processing (% , dB, etc.), and ratio arithmetic processing (RATIO) can be performed as needed.

d) Reference Signal System (REFERENCE CKT)

An internal reference signal (sine wave at a constant amplitude) used by the PSD is supplied by the internal oscillator.

External Reference Signal

In principle, a lock-in amplifier performs the measurements using an external reference signal (REF IN) as the reference of the frequency and phase. If the reference signal source is an external reference signal, the internal oscillator generates a sine wave synchronized with the external reference signal (the frequency and phase match) using a Phase Locked Loop (PLL).

Internal Oscillator

If the reference signal source is internal (INT OSC), the internal oscillator oscillates a signal at a frequency specified by a numerical value. The internal oscillator uses a direct digital synthesis method so the frequency is stabilized immediately after it is set.

The signal of the internal oscillator is output as a sine wave (OSC OUT) or TTL-level square wave (REF OUT). If the amplitude of OSC OUT is set to zero, interference (crosstalk) from the reference signal to the measured signal can be reduced, which is often a problem in particular at high frequencies.

The internal oscillator has a function to generate a harmonic (harmonic, subharmonic, and fractional harmonic) signal.

Two reference signals are generated for the dual frequency simultaneous measurement. A fundamental wave and harmonic wave or the primary frequency and an arbitrary secondary frequency independent from it (specified by a numerical value) can be used.

Synchronization with the Measured Signal

If the measured signal is specified for the reference signal source (SIGNAL), the internal oscillator is controlled so that the measured phase value is set to zero (the frequency and phase match).

External 10 MHz Synchronization

If a reference frequency for frequency synthesis is applied to (10MHz IN) from an external source, the internal oscillator generates a reference signal synchronized with that reference frequency. Therefore, measurement can be performed without applying an external reference signal (REF IN). Not only the signal frequency but also the signal sampling rate, output update rate, and the rate for recording to the data memory by the internal timer are also synchronized with the external 10 MHz.

2. Preparation Before Use

2.1	Checking Before Use	2-2
2.2	Installation	2-4
2.2.1	General Precautions for Installation	2-4
2.2.2	Installation Conditions	2-4
2.2.3	Rack Mounting	2-5
2.3	Grounding and Connecting to Power Outlet	2-10
2.4	Simplified Operation Check	2-13
2.5	Calibration	2-14

2.1 Checking Before Use

■ Safety Check

To ensure the safety, refer to "Safety Precautions" at the beginning of this instruction manual before using the LI5655 / LI5660.

Furthermore, before connecting to the power supply, read "2.3 Grounding and Connecting to Power Outlet" to ensure the safety.

■ Unpacking

Check that the device has not been damaged during transport.

After unpacking, refer to "Table 2-1 Composition List" to check the contents.

Table 2-1 Composition List

LI 5655 or LI 5660	1
Accessories	
Instruction Manual (Operations).....	1
CD-ROM (Contents  Next page)	1
Power cord set (3-pole/2 m)	1
Fuse (time lag, $\phi 5.2 \times 20$ mm)	1
Protective cap (for current input connector)	1

WARNING

There are high voltage parts inside this device. Never remove the cover.

No one except trained service technicians who have knowledge of hazard prevention is authorized to check the inside of this device.

■ Contents of the Supplied CD-ROM

- LI5655 / LI5660 Instruction Manual (Operations)
This manual (in PDF format).
- LI5655 / LI5660 Instruction Manual (Remote Control)
Describes how to remotely control the LI5655 / LI5660 (in PDF format).
- IVI (Interchangeable Virtual Instruments) driver
Driver for handling the main commands and queries in the LI5655 / LI5660, which can be used in various programming languages. In LabVIEW, the IVI driver can be imported and converted to ".vi" or ".lib".
- Sample Programs
Show examples of controlling the LI5655 / LI5660 using programming languages such as C# and VB.NET and various interfaces.

The above is just an outline. For details, refer to the instruction manual on the CD-ROM.

2.2 Installation

2.2.1 General Precautions for Installation

CAUTION

Observe the following points. Otherwise, the LI5655 / LI5660 may be damaged.

- The LI5655 / LI5660 uses a forced air cooling system using a fan.
Do not block the rear panel which has an air exhaust vent and both sides which have air intake ports.
 - Do not install the LI5655 / LI5660 on its back or side. There is a risk of it falling over.
Install it so that all of the four feet on the bottom sit on the flat surface of a table, etc.
-

2.2.2 Installation Conditions

- **Install this product in a place that satisfies the following temperature and humidity conditions.**
Operation: 0 to +40°C , 5 to 85 %RH (Absolute humidity 1 to 25 g/m³, non-condensing)
Storage: -10 to +50°C , 5 to 95 %RH (Absolute humidity 1 to 29 g/m³, non-condensing)
- **Install the device at an altitude below 2,000 m.**
- **Avoid use in the environment of a strong radio frequency magnetic field where the measured values may fluctuate temporarily.**

CAUTION

Avoid installation in the following locations.

- Where there is flammable gas
There is a risk of explosion. Never install or use it in such a location.
 - Outdoors, where exposed to direct sunlight, or near fire or a heat source
The performance may not be satisfied, or a failure may occur.
 - Where there are corrosive gases and vapors, a lot of dust and particles, salty air and oily smoke, and metal powder, etc.
Corrosion or a failure may occur.
 - Where there is a lot of vibration
Malfunction or a failure may occur.
 - Near an electromagnetic field source, high-voltage equipment, power line, or pulse noise source
Malfunction or a failure may occur.
-

Install the LI5655 / LI5660 and parts that may cause noise such as power cables of other equipment away from the signal cable. If they are installed close to each other, a malfunction or measurement error may occur.

To ensure correct measurement, warm up the device for at least 30 minutes before use.

2.2.3 Rack Mounting

The LI5655 / LI5660 can be mounted in a 19-inch IEC rack, EIA standard rack, or JIS standard rack by attaching the rack mount kit (optional). Rack mount kits for Milli rack (JIS) and Inch rack (EIA) are available.

First, attach the rack mount kit as shown in Figure 2-1 Rack Mount Assembly Drawing (JIS) and Figure 2-2 Rack Mount Assembly Drawing (EIA) , and then mount the device to a rack.

WARNING

When mounting to a rack, be sure to mount rack rails, etc. to support the LI5655 / LI 5660. Otherwise, a fall may cause injury, or the LI 5655 / LI 5660 may be damaged.

CAUTION

- Provide the rack with ventilation holes or a cooling fan for cooling.
 - The LI5655 / LI5660 has an air intake port on both sides.
Provide clearance of at least 20 mm from the wall, etc. at the sides
 - There is an air exhaust vent on the rear panel.
Provide clearance of at least 50 mm panel from the wall, etc. at the rear
If the ambient temperature exceeds the specified limit, or air intake or exhaust is blocked, the LI5655 / LI 5660 may be damaged.
-

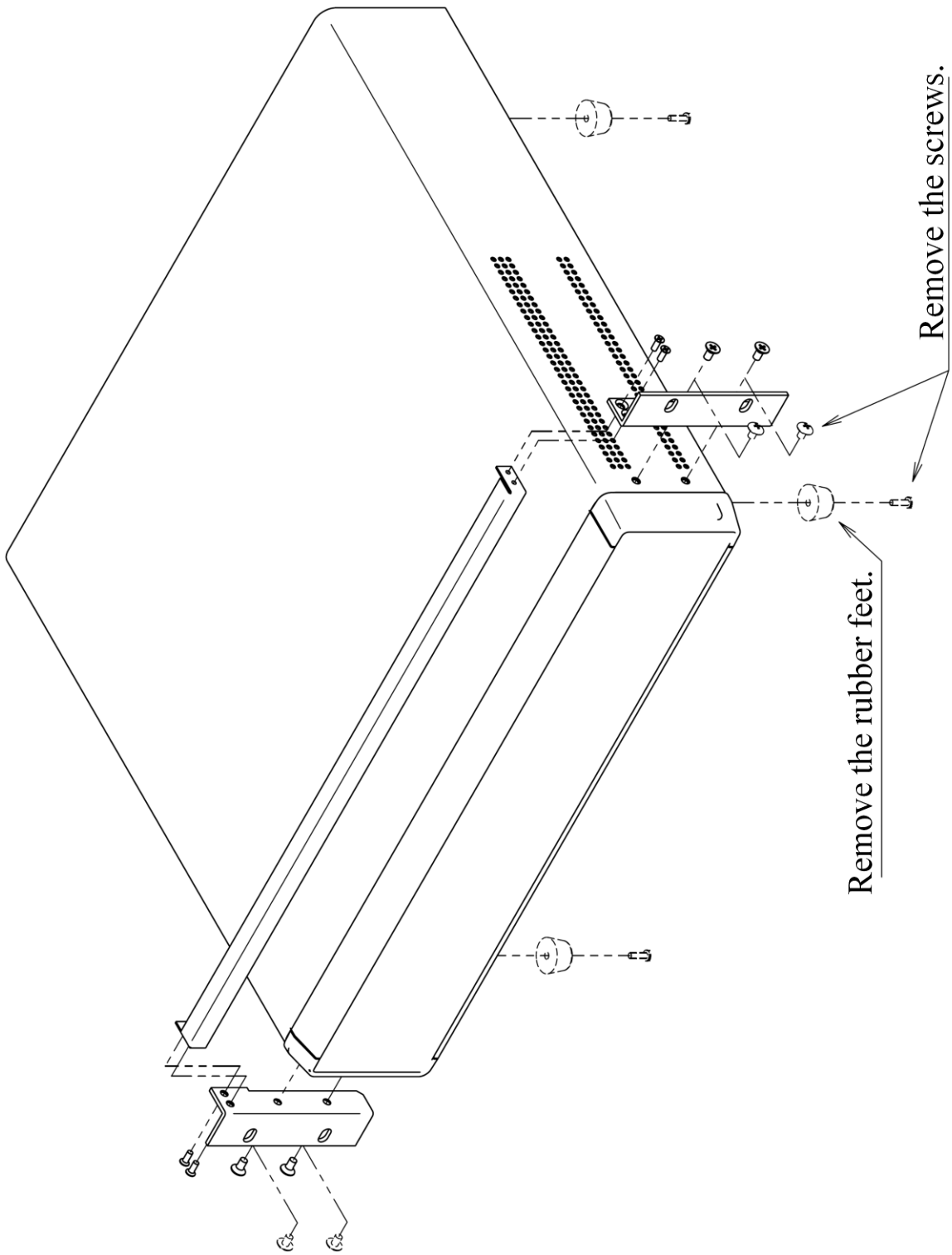

Figure 2-1 Rack Mount Kit Assembly Drawing (JIS)

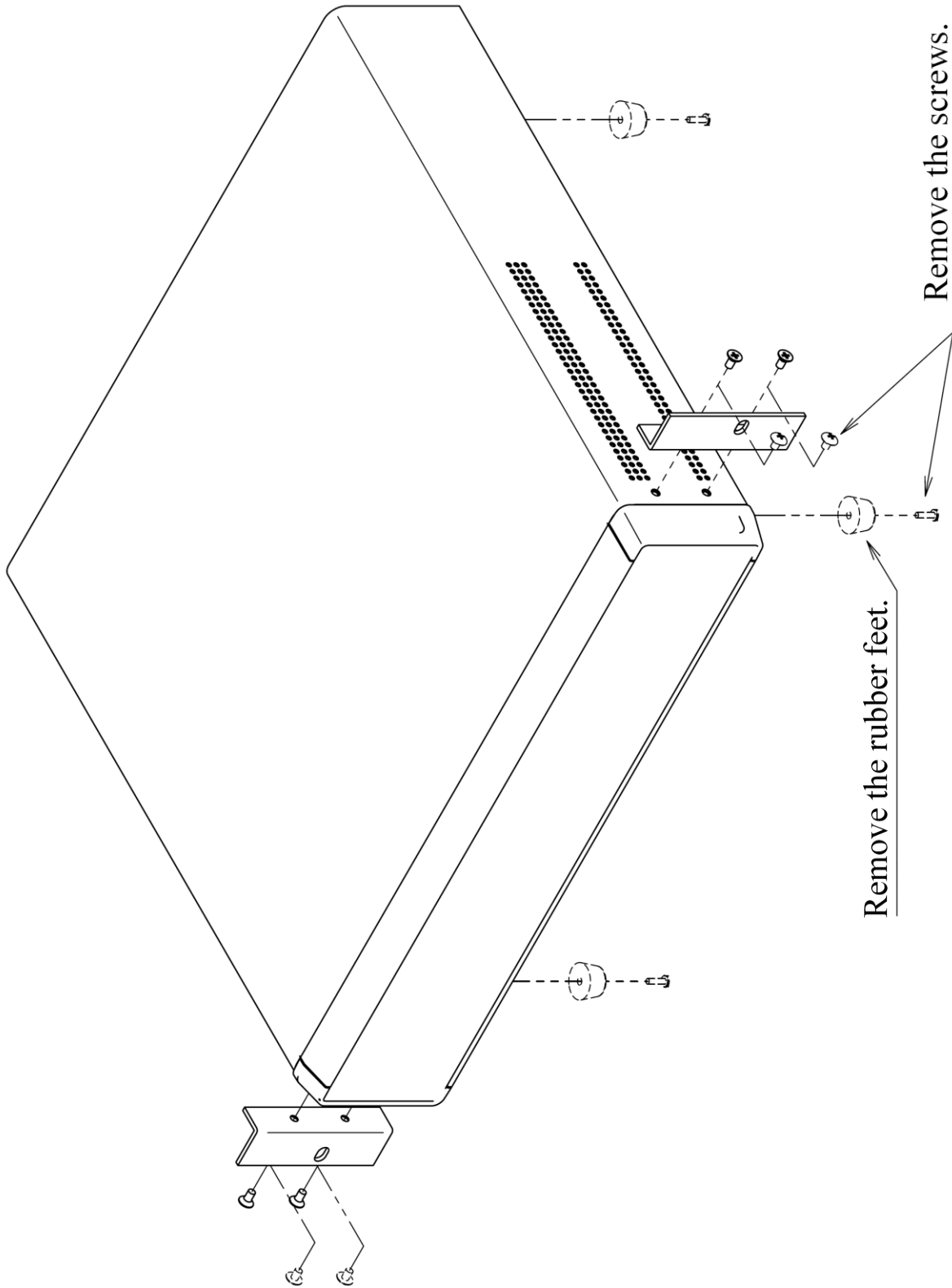
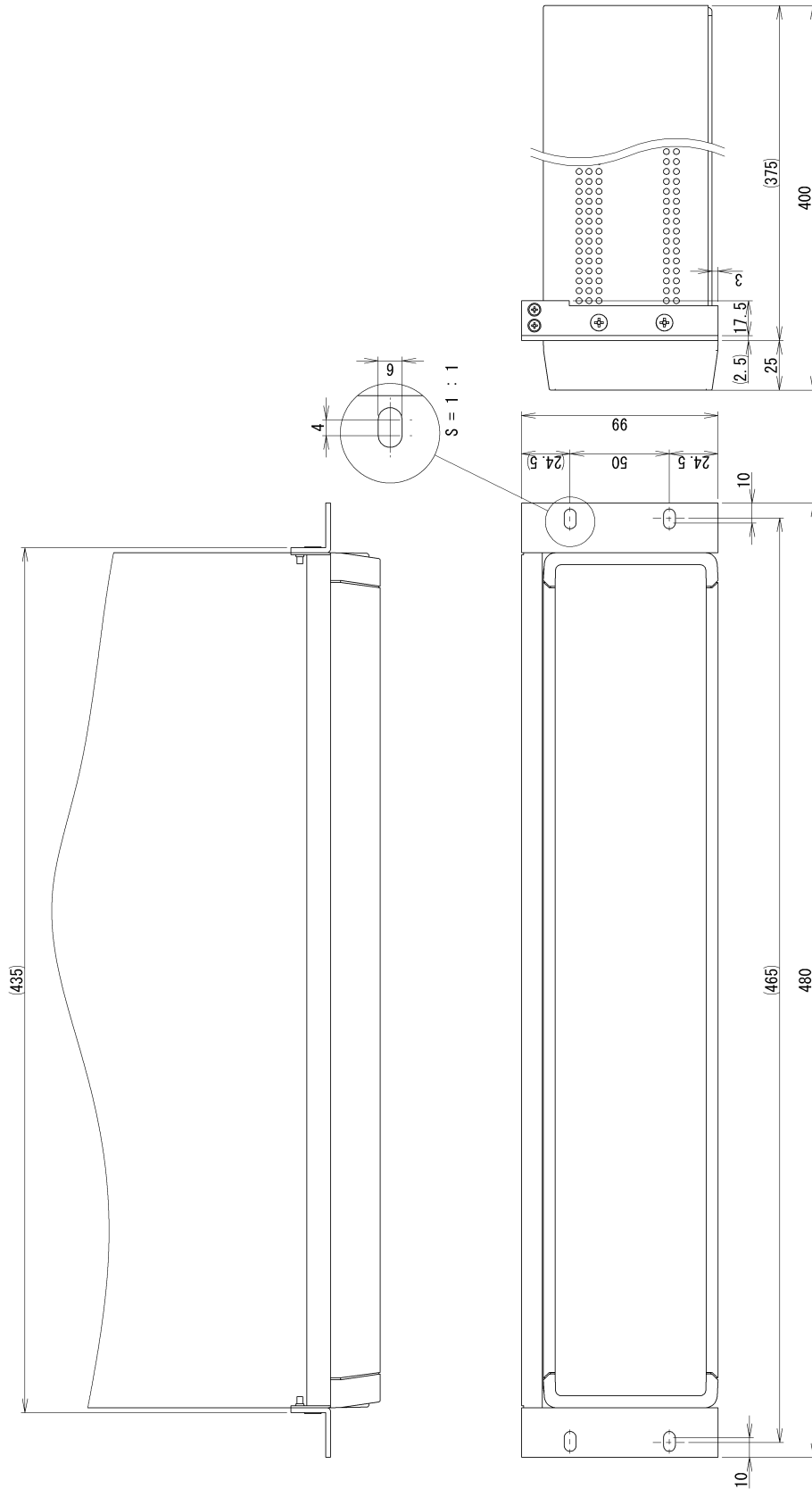

Figure 2-2 Rack Mount Kit Assembly Drawing (EIA)



CAUTION
 When storing in a rack, do not secure the units using only a rack mount adapter.
 Always secure the units using L-shaped brackets or a shelf.

Figure 2-3 Rack Mount Dimensions (JIS)

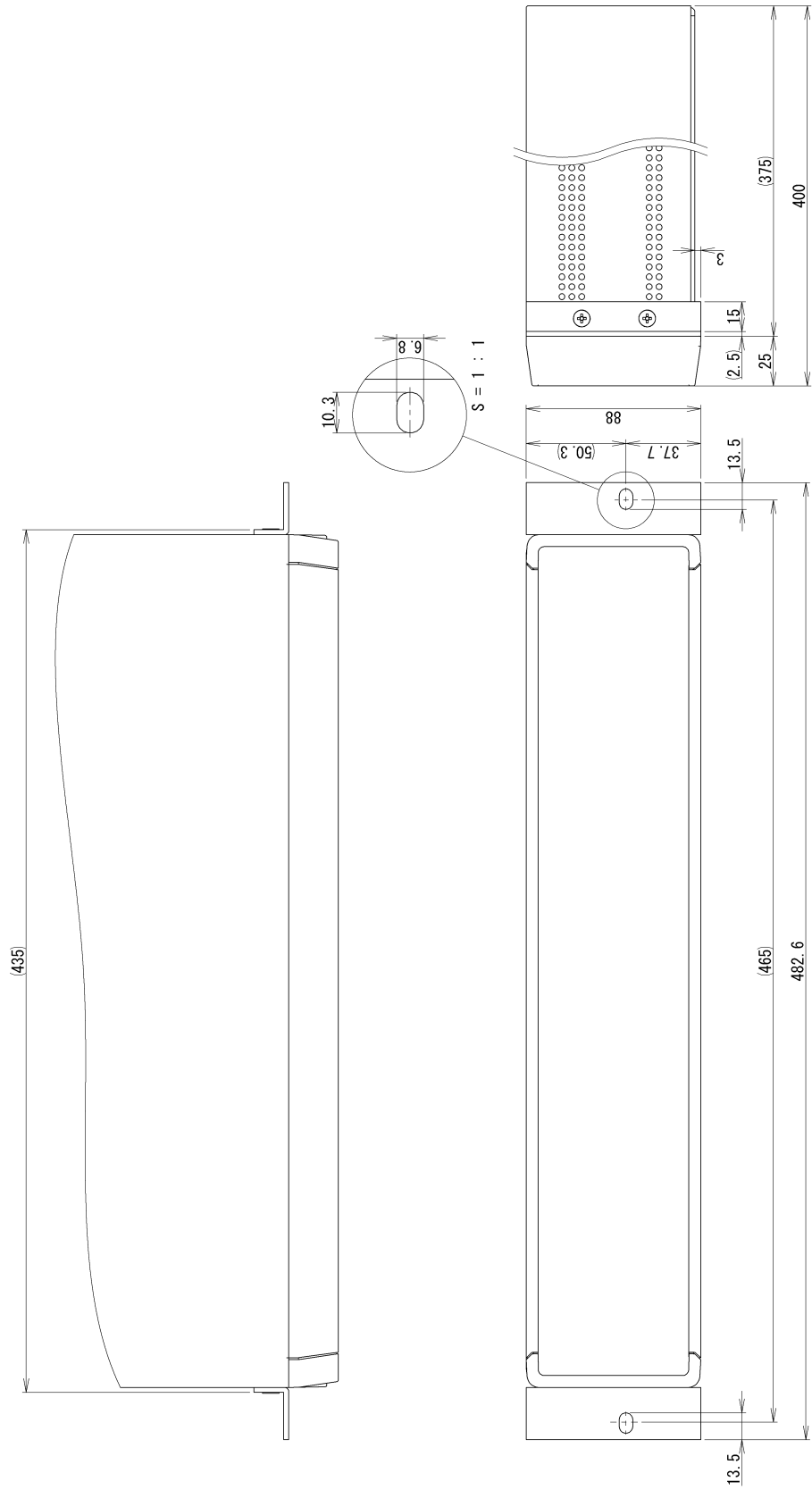

Figure 2-4 Rack Mount Dimensions (EIA)

CAUTION
 When storing in a rack, do not secure the units using only a rack mount adapter.
 Always secure the units using L-shaped brackets or a shelf.

2.3 Grounding and Connecting to Power Outlet

- Be sure to perform grounding.

⚠ WARNING

The LI5655 / LI5660 uses a line filter, which may cause electric shock if the device is not grounded.

To prevent electrical shock, connect it to an earth ground so that ground resistance is 100 Ω or less.

The LI5655 / LI5660 is automatically grounded by connecting a 3-pin power plug to a 3-pin power outlet with a protective ground contact.

- The following shows the power supply conditions for this product.

Voltage range	:100 V AC \pm 10% / 120 V AC \pm 10% / 230 V AC +10%, -14% however, 250 V or less
Frequency range	:50 Hz / 60 Hz \pm 2 Hz
Overvoltage category	: II
The maximum power consumption is 75 VA.	

This product has a power supply voltage selector switch on the rear panel. Check that the voltage of the outlet matches the voltage set with the power supply voltage selector switch.

To change the power supply voltage, disconnect the power cord and then turn the selector switch with a small flat-head screwdriver slowly until you hear a click so that the key points to the setting voltage.

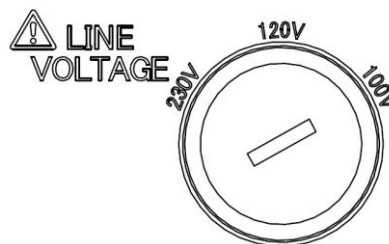

Figure 2-5 Power Voltage Selector Switch

⚠ CAUTION

Set the power supply voltage selector switch to the position where it clicks to prevent the switch from being in a half-way position.

Check the power supply voltage selector switch setting and then connect the product to the power outlet.

■ Perform the following steps to connect to the power outlet.

- 1) Check that the power outlet voltage to be connected is within the voltage range of this product.
- 2) Turn off the power switch of this product.
- 3) Connect the power cord to the power inlet on the rear panel of this product.
- 4) Insert the plug of the power cord into the power outlet with a protective ground contact.

⚠ CAUTION

Note that the supplied power cord set is specifically for use with the LI5655 / LI5660.

Do not use it for any other product or purpose.

Be sure to use the supplied power cord set to connect the product to the power outlet.

When turning the power off and then back on, wait at least 5 seconds before turning the power back on.

- The power cord can be used to disconnect the LI5655 / LI5660 from the AC power outlet in case of an emergency.

⚠ WARNING

To ensure that the power cord can be disconnected from the power inlet on the LI 5655 / LI5660, allow sufficient space around the inlet. Furthermore, to ensure that the power plug can be disconnected from the outlet, use an outlet in an easily accessible location and allow sufficient space around the outlet.

If you notice smoke or a strange odor or sound being emitted from the device, promptly disconnect the power cord, and do not use it until a repair is completed.

■ Observe the rating of the fuse.

The following shows the rating of the fuse of the LI5655 / LI5660.

Power supply voltage 100 V / 120 V : Rated current 1.0 A, rated voltage 250 V

Power supply voltage 230 V : Rated current 0.5 A, rated voltage 250 V

Other characteristics

Electrical characteristic : Time lag

Dimensions : $\phi 5.2 \times 20$ mm

To replace the fuse, disconnect the power cord, and then turn the fuse holder on the rear panel left with a flat-blade screwdriver and pull it out. Replace the old fuse with a new one, insert the fuse holder, and turn it right with a screwdriver to lock it.

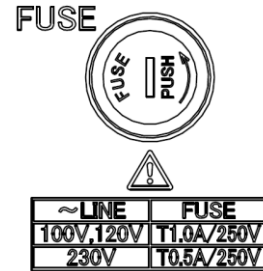

Figure 2-6 Fuse Replacement

⚠ WARNING

Before connecting to the power supply, check that the power supply voltage selector switch setting and the rating of the fuse match the power supply. To change the power supply voltage selector switch setting and replace the fuse, be sure to disconnect the power cord from the power inlet on the LI5655 / LI5660 or the outlet. Otherwise, the LI5655 / LI5660 may be damaged, or electric shock or fire may occur.

⚠ WARNING

There are high voltage parts inside this device. Never remove the cover.

2.4 Simplified Operation Check

It is recommended to perform an operation check with the following procedure after you purchase the LI5655 / LI5660 or you have not used it for an extended period of time. (Prepare an oscillator and two 1-m BNC cables.)

1. Connect to the power supply and then turn on the power switch.
 Wait until the startup screen disappears and the measurement screen appears.
 For details on the startup, see "4.1.2 Startup Screen and Operation on Startup"
2. Reset the settings.
 Press the **UTIL** key, the [RESET>] soft key, and the [Exec] soft key.
3. Select the internal oscillator (INT OSC) for the reference signal source.
 Press the **REF** key and the [SOURCE] soft key.
 Select INT OSC using the up/down keys or MODIFY knob.
4. Connect the OSC OUT connector and the SIGNAL INPUT A connector with a BNC cable.
5. Check that measurement can be performed correctly.
 Change the output amplitude of the internal oscillator and check that the amplitude setting and the measured value (R: magnitude of the signal) is almost the same.
 Press the **REF** key and the [OSC SET>] soft key, and then press the [FREQ>] soft key to change the frequency, or press the [AMPTD>] soft key to change the amplitude.
6. Select the external reference signal (REF IN) for the reference signal source.
 Press the **REF** key and the [SOURCE] soft key.
 Select REF IN using the up/down keys or MODIFY knob.
 Press the [EDGE] soft key and operate the up/down keys or MODIFY knob to select SIN (Rise +) or TTL-level square wave (Rise + / Fall -).
7. Prepare another oscillator (NF Corporation's Multifunction Generator WF1947, etc.) and configure the following settings.
 Waveform: Sine wave (SYNC OUT: TTL level, Duty: 50% square wave)
 Oscillation mode: Continuous oscillation
 Frequency: 1 kHz (change it within the range to be checked)
 Amplitude: 1 Vrms (change it within the range to be checked)
8. Connect the output signal of the oscillator to the LI5655 / LI5660.
 Oscillator synchronous signal (SYNC OUT) → LI5655 / LI5660 REF IN connector
 Oscillator primary output (FUNC OUT) → LI5655 / LI5660 A connector
9. Check the synchronization function for the external reference signal.
 When the signal is synchronized, the UNLOCK icon on the measurement screen disappears and the same frequency as the external oscillator is displayed. Change the frequency and amplitude of the external oscillator and check that measurement can be performed correctly.

The simplified operation check is now complete.

It is recommended to reset the settings.

2.5 Calibration

Perform the performance test described in "8.6 Performance Test" at least once every year for the LI5655 / LI5660, which may vary depending on the operating environment and frequency. Furthermore, it is recommended to perform the performance test before using the device for important measurements and tests.

If the performance test results do not satisfy the specifications, NF Corporation will perform adjustment or calibration to restore the original performance. If calibration or adjustment is required, contact NF Corporation or one of our representatives. Charges apply for calibration and adjustment services.

3. Panel Operation List

3.1	Panel Part Names and Operations	3-3
3.1.1	Front Panel.....	3-3
3.1.2	Rear Panel	3-4
3.2	I/O Connector	3-6
3.2.1	Signal Input Connector.....	3-7
3.2.2	Reference Signal Input Connector	3-9
3.2.3	Analog Output	3-10
3.2.4	Auxiliary I/O Connector	3-11
3.2.5	Other I/O Connector	3-12
3.3	Overview of the Measurement Screen	3-13
3.3.1	Types and Switching between Measurement Screens	3-13
3.3.2	Measurement Screen	3-13
3.3.3	Details of the Measurement Screen	3-15
3.3.4	Operations in the Measurement Screen.....	3-17
3.4	Overview of the Operation Screen.....	3-18
3.4.1	Operation Keys and MODIFY Knob	3-18
3.4.2	Operation Screen Configuration	3-20
3.5	Operation Tree	3-21
3.5.1	Operation Tree in the Measurement Screen.....	3-21
3.5.2	Operation Tree in the Measurement Screen (SINGLE)	3-22
3.5.3	Operation Tree in the Operation Screen (DUAL1).....	3-27
3.5.4	Operation Tree in the Operation Screen (DUAL2/CASCADE)	3-30
3.6	Operation Screen Reference	3-31
3.6.1	AUTO : {Auto Setting Screen}.....	3-32
3.6.2	DATA : {Output Signal Setting Screen}.....	3-34
3.6.3	SENS : {Sensitivity Setting Screen}	3-42
3.6.4	TC : {Time Constant Filter Setting Screen}	3-43
3.6.5	SIG : {Input Signal Selection Screen}.....	3-45
3.6.6	PHASE : {Phase Adjustment Screen}.....	3-47
3.6.7	REF : {Reference Signal Setting Screen}.....	3-48
3.6.8	AUX : {Auxiliary I/O Setting Screen}	3-53
3.6.9	UTIL : {Utility Screen}.....	3-55
3.7	Initial Settings	3-63

This chapter describes the panel part names, operating system, and basic information common to various operations.

Before reading Chapter 4 and onwards, please first read sections 3.1, 3.3, and 3.4.

If you wish to view the overall picture of the operating system or if you wish to know to which operation screen a particular operation object is assigned, please see "3.5 Operation Tree."

For operations that are not described in detail in Chapter 4 and onwards, please see "3.6 Operation Screen Reference."

3.1 Panel Part Names and Operations

This section provides an overview of the part names, functions, and operations of the front and rear panels.

3.1.1 Front Panel

*1: Only the LI5660 is equipped with C and HF.

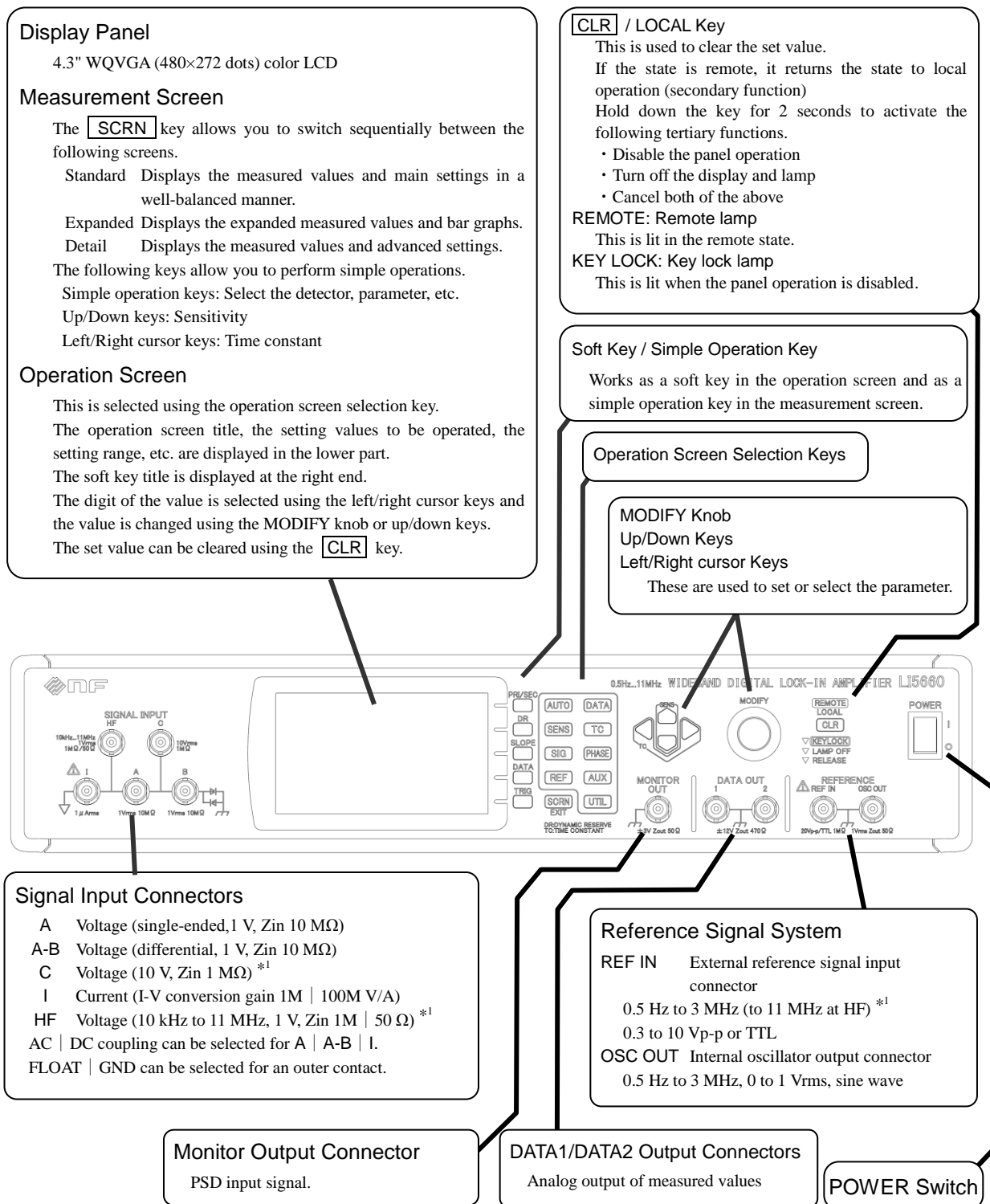

Figure 3-1 Front Panel

3.1.2 Rear Panel

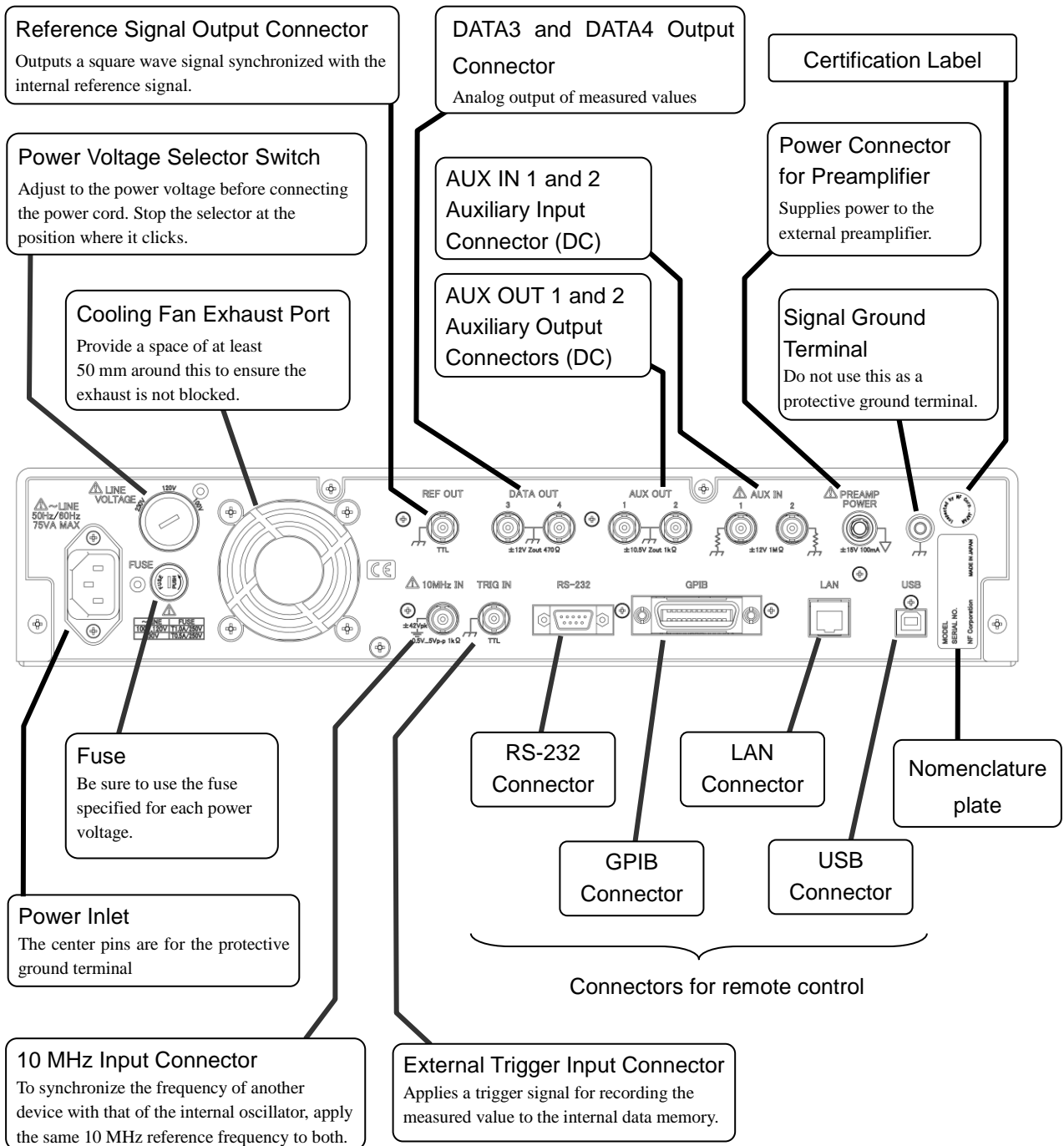

Figure 3-2 Rear Panel

For details, refer to the description of the operations in Chapter 4 and onwards, as well as "9. Specifications."

For remote control, refer to "LI5655 / LI5660 Instruction Manual (Remote Control)" on the supplied CD ROM.

■ Notation of the Screens and Keys in this Instruction Manual

{Screen Names}

These are the names of screens displayed on the display panel. Screens are classified into the following two types.

Measurement Screens {Standard | Expanded | Details}

Displays the main measured values and settings.

Operation Screens

Displays the following.

- Main measured values and settings
- Names and values of parameters to be operated and comments such as the setting range
- Soft key functions

Hard Key Title

Indicates a key with this name or symbol printed on the key top.

A cursor key indicates the direction by its shape and the title is not printed on it.

Hard Key Title / Secondary Function Name

Indicates a key that has the main function printed on the key top and a secondary function printed near it. When the secondary function is executed in this instruction manual, a notation with "/ secondary function name" added to the key is used. If the main function is executed, "/ secondary function name" is not added.

[Soft Key Title]

Indicates a soft key that has this function.

A hard key

refers to a key that is a physical entity with one or several functions.

With regard to a hard key with multiple functions, a secondary function may be enabled according to the situation.

A soft key

refers to a key, whose function changes depending on the situation.

The function displayed on the right end of the screen on the display panel is enabled in the operation screen.

The soft key works as a simple operation key in the measurement screen, and the secondary function indicated directly above the key is enabled.

A secondary function

refers to a function not indicated on the key top, but near the key (above or under it).

3.2 I/O Connector

WARNING

To prevent electric shock, ensure that the auxiliary input connector (AUX IN) of BNC isolated from the enclosure and external 10 MHz synchronous connector (10 MHz IN) do not apply a voltage exceeding ± 42 Vpk (DC + AC peak) between the BNC connector (center contact and ground) and the enclosure.

Likewise, to prevent electric shock, do not apply a voltage exceeding ± 42 Vpk (DC + AC peak) between the auxiliary input connector (AUX IN) and external 10 MHz synchronous connector (10MHz IN).

If this voltage is exceeded, the internal voltage limiting element works to suppress the voltage, but if the applied voltage is large, this product may be damaged.

CAUTION

Do not apply a voltage exceeding the maximum input voltage range to the input connector. This product may be damaged.

CAUTION

Do not apply a voltage to the output connector from outside. This product may be damaged.

3.2.1 Signal Input Connector

*1: Only the LI5660 is equipped with C and HF.

1) Signal Ground

The signal ground for the signal input connectors (the following A, B, C^{*1}, HF^{*1}, and I connectors) is isolated from the enclosure in a range of ±1 V.

Floating voltage (allowable voltage to ground) : ±1 V_{peak} (DC + AC)

Impedance to enclosure when floating : 10 kΩ (nominal value)

When grounded : 11 Ω (nominal value)

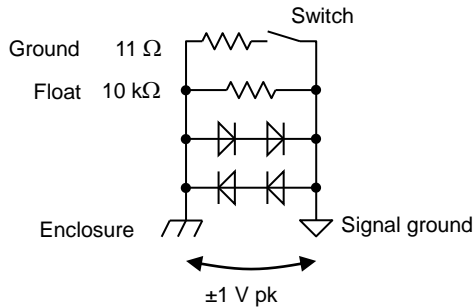

The ground impedance between the signal ground and enclosure can be switched between float and ground. If a voltage exceeding ±1 V is applied, this isolation cannot be maintained.

CAUTION

42 V_{peak} (DC+AC) cannot be applied between the signal ground and enclosure. If a voltage exceeding 1.0 V is applied, a large current flows and damages the internal circuit.

2) Voltage Measurement Input Connectors (A and B)

The following shows the voltage measurement connectors A and B.

- Input impedance : 10 MΩ (nominal value), 50 pF in parallel (supplementary value)
- Maximum input voltage (linear operating range) : ±3 V (each connector voltage and differential voltage in DC coupling)
- Non-destructive maximum input voltage AC coupling : Sine wave 10 V_{rms}, ±42 V DC
- DC coupling : ±14 V

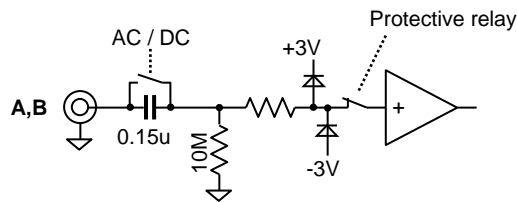

CAUTION

If the signal significantly exceeds the maximum input voltage range, the input connector may temporarily be separated from the inside for protection.

3) Voltage Measurement Input Connector *1 (C)

Input impedance	: 1 M Ω (nominal value), 50 pF in parallel (supplementary value)
Maximum input voltage (linear operating range)	: ± 30 V
Non-destructive maximum input voltage	: ± 42 V

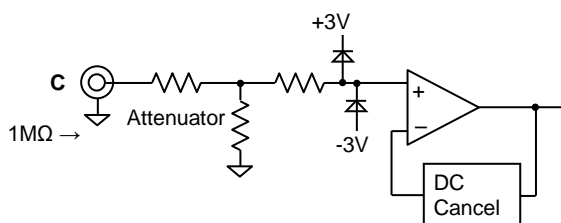

4) Voltage Measurement Input Connector *1 (HF)

Input impedance	: 1 M Ω (nominal value), 50 pF in parallel (supplementary value) 50 Ω (nominal value)
Maximum input voltage (linear operating range)	: ± 3 V
Non-destructive maximum input voltage	: ± 5 V

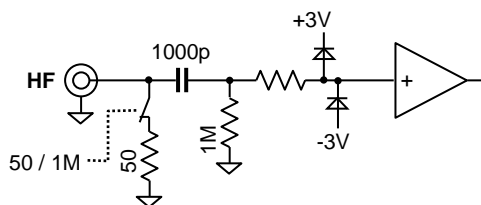

5) Current Measurement Input Connector (I)

Input impedance	: 1 k Ω (conversion gain 1 M, supplementary value) 100 k Ω (conversion gain 100 M, supplementary value)
Maximum input current (linear operating range)	: ± 3 μ A (conversion gain 1 M, DC coupling)
Non-destructive maximum input current	: ± 10 mA

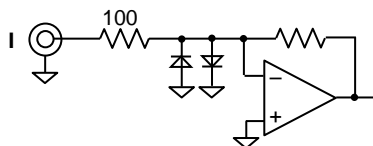

CAUTION

If a current of ± 10 mA or more flows, the internal circuit will be damaged. Attach the supplied protective cap if the input current will not be used.

3.2.2 Reference Signal Input Connector

1) Reference Signal Input (REF IN)

If the EDGE setting is changed for the reference signal input connector, the internal circuit is also changed.

Input impedance	: 1 M Ω (nominal value), 100 pF in parallel (supplementary value)
Input voltage range, SINE	: 0.3 V to 20 Vp-p
TTL	: 0 to 5 V (Low 0.8 V or less, High 2.6 V or more)
Non-destructive maximum input voltage	: ± 15 V

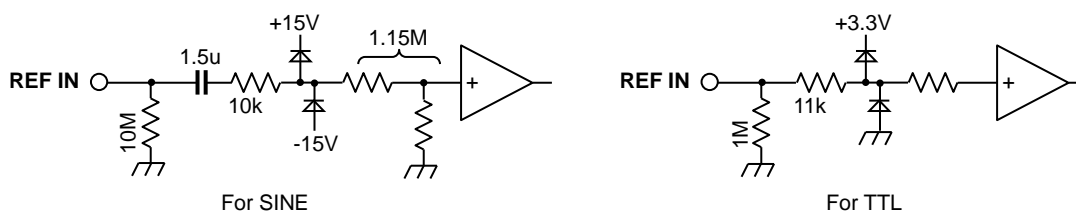

2) Sine Wave Output (OSC OUT)

A sine wave synchronized with the internal oscillator is output from the OSC OUT connector. If the synchronous source is the external reference signal (REF IN), the output is synchronized with the external reference signal source.

Output voltage range	: 0.00 mVrms to 1.000 Vrms
Maximum output current	: ± 15 mA
Output impedance	: 50 Ω (nominal value)

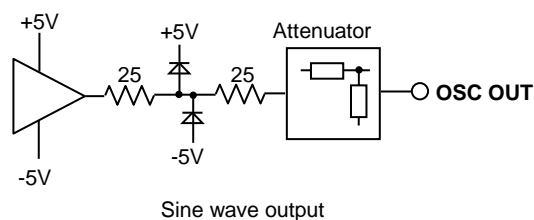

If the frequency is 3.2 MHz or more, the output is 0 Vrms regardless of the setting.

3) Square Wave Output (REF OUT)

A logic signal synchronized with OSC OUT is output.

Signal level	: TTL (0 to 3.3 V, nominal value)
Maximum output current	: ± 8 mA

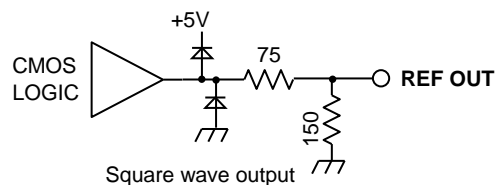

If the frequency is 3.2 MHz or more, the output level is fixed to HIGH or LOW.

⚠ CAUTION

Do not apply a voltage exceeding the maximum input voltage range to REF IN.

There is a limit of output current at OSC OUT

Ensure that the load to the REF OUT ground or +3.3 V is 500 Ω or more.

3.2.3 Analog Output

1) Measured Value Output (DATA OUT)

The following shows the DATA OUT1 and 2 on the front panel and DATA OUT3 and 4 on the rear panel.

A voltage in proportion to the measurement display values (R, X, Y, etc.) is output.

For details, see "4.3 Measurement Parameter Setting, Output, and Display."

Output voltage range	: ± 12 V (with no load)
Maximum output current	: ± 10 mA
Output impedance	: 470 Ω (nominal value)

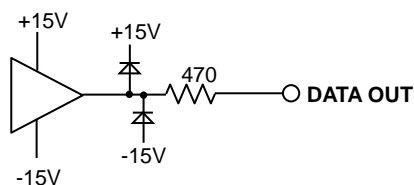

2) Monitor Output (MONITOR OUT)

Input signal to the phase sensitive detector.

For details, see "4.7.3 Signal Over-level Display and Monitor Output."

Maximum output voltage	: ± 3 V (with no load)
Maximum output current	: ± 20 mA
Output impedance	: 50 Ω (nominal value)

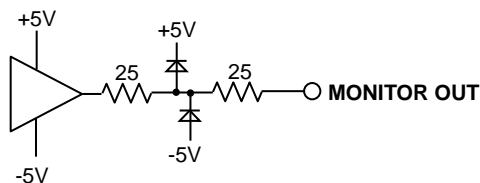

3.2.4 Auxiliary I/O Connector

1) Auxiliary Input (AUX IN1 and AUX IN2)

AUX IN1 is used for ratio measurement.

For details, see "5.8 DC Voltage Measurement (AUX IN)"

Input impedance : 1 M Ω (nominal value), 50 pF in parallel (supplementary value)
If the signal ground is equal to the enclosure potential

Maximum input voltage (linear operating range)
: ± 12 V

Non-destructive maximum input voltage
: ± 42 V_{peak} (DC+AC)

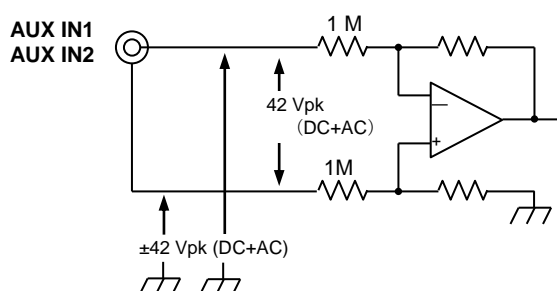

2) Auxiliary Output (AUX OUT1 and AUX OUT2)

For details, see "5.9 DC Voltage Output (AUX OUT)."

Output voltage range : ± 10.500 V

Maximum output current : ± 5 mA

Output impedance : 1 k Ω (nominal value)

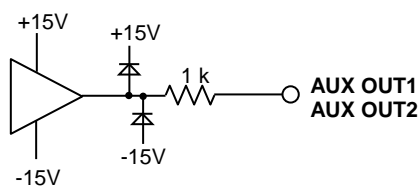

3.2.5 Other I/O Connectors

1) External 10 MHz Synchronization (10 MHz IN)

Input impedance	: 1 k Ω (nominal value), AC coupling
Signal level	: 0.5 V _{p-p} to 5 V _{p-p}
Non-destructive maximum input voltage	: 10 V _{p-p}
Floating voltage (allowable voltage to ground)	: ± 42 V _{peak} (DC + AC)

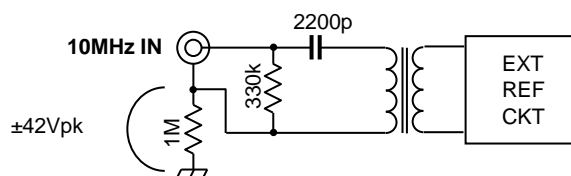

2) Trigger Input (TRIG IN)

Trigger input to start recording to the internal data memory.

Input impedance	: 10 k Ω (nominal value)
Signal level	: TTL (Low 0.8 V or less, High 2.6 V or more)
Non-destructive maximum input voltage	: ± 15 V

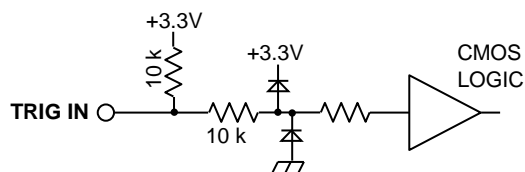

3) Power Output for Preamp (PREAMP POWER)

The ground for the power output for the preamplifier is a signal ground.

Maximum output current	: ± 100 mA
------------------------	----------------

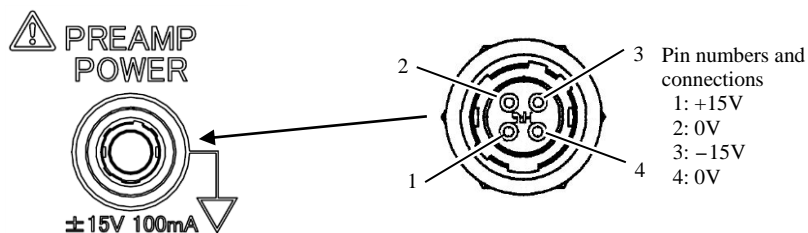
**CAUTION**

PREAMP POWER is intended to supply power to the external amplifier. Do not use it for any other purpose, because doing so will adversely affect measurements or may cause a failure.

3.3 Overview of the Measurement Screen

3.3.1 Types and Switching between Measurement Screens

There are 3 types of measurement screen displays: Normal, Large, and Fine measurement screens.

When the **SCRN** key is pressed, the screen is changed sequentially as follows.

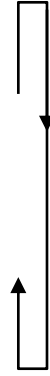
- 
- a) Normal Measurement Screen (Default)
Displays the measured values, bar graphs, and main settings in a well-balanced manner.
 - b) Large Measurement Screen
Displays the expanded measured values and bar graphs.
The setting information display area is smaller.
 - c) Fine Measurement Screen
As much setting information as possible is displayed.
The measured value display area is smaller.
There is no bar graph display. Instead DATA1 to DATA4 are all displayed.

The **SCRN** / EXIT key is also used to move to the upper-level operation screen and return to the measurement screen.

3.3.2 Measurement Screen

The following shows an example of each measurement screen display (when the detection mode is SINGLE).

1) Normal Measurement Screen

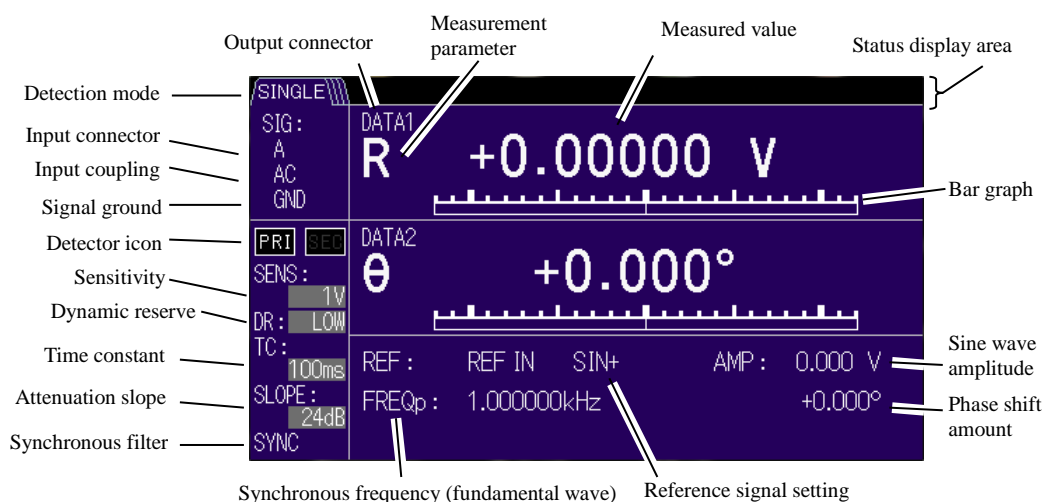

2) Large Measurement Screen

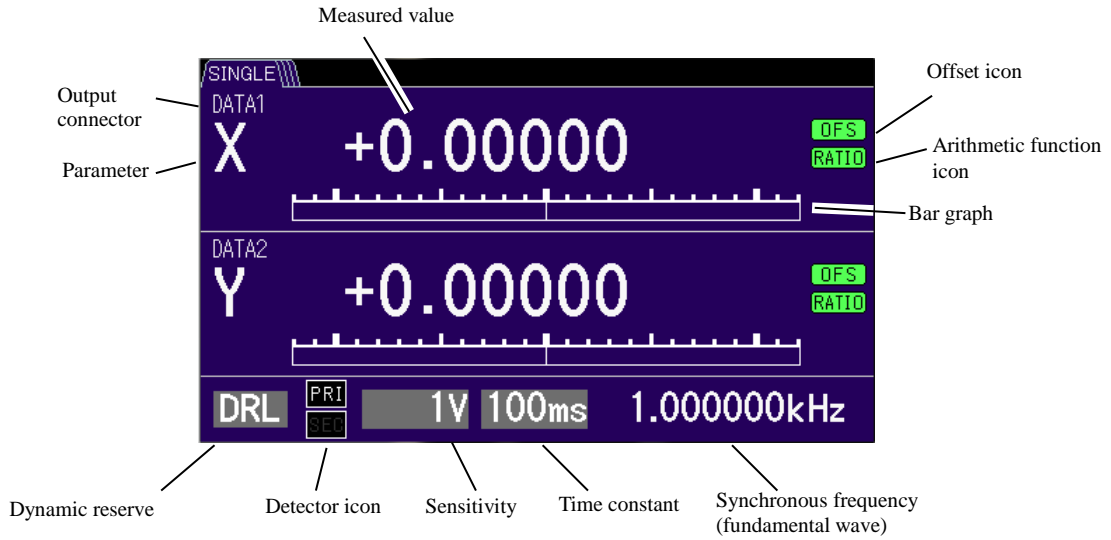

3) Fine Measurement Screen

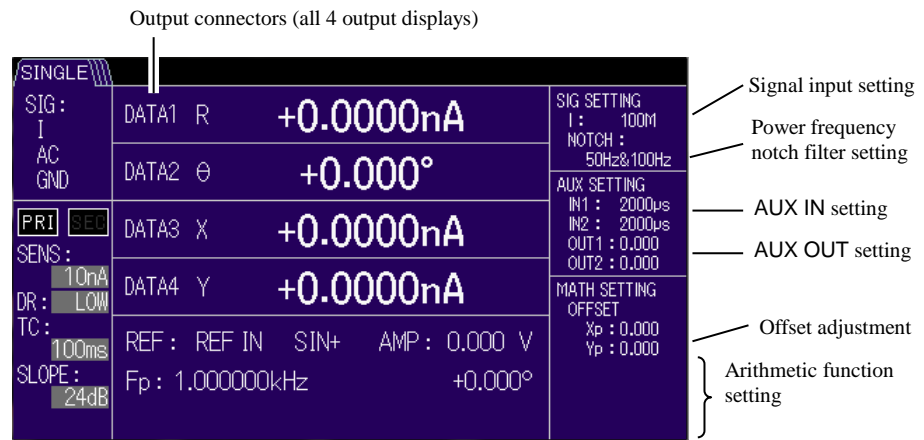

3.3.3 Details of the Measurement Screen

The following describes the status display area and measurement screen for two-frequency measurement.

■ Status Display Area



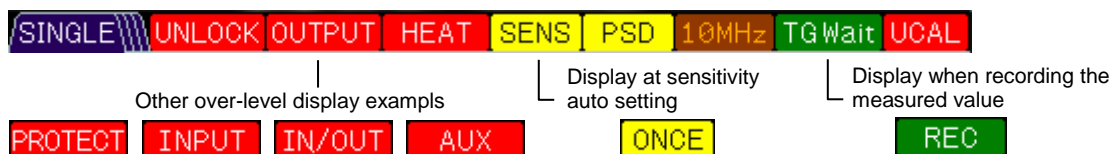

The following describes the icons displayed in the status display area.



Status	Description
UNLOCK	Indicates out-of-sync. The signal is not synchronized with the reference signal. The reference signal may not be connected or set correctly, or the reference signal level may be low, or the signal may be outside the measurement frequency range.
OUTPUT, etc.	Indicates signal over-level. Indicated if the input signal is large, the amplifier is saturated, or the time constant filter after the phase sensitive detector is saturated. For details, see "4.7.3 Signal Over-level Display and Monitor Output."
HEAT	Indicates overheat condition. Indicated if the internal temperature of the product is extremely high. If this indication appears when the ambient temperature is 40°C or less and the installation is correct, a failure has occurred, so contact NF Corporation or one of our representatives.
SENS	Indicated during operation of auto sensitivity adjustment. "ONCE" is displayed only during automatic sensitivity adjustment operation once.
PSD	Indicated during operation of auto PSD offset adjustment.
10MHz	Indicates whether external 10 MHz synchronization is valid or invalid.
TGWait, Etc.	Indicates waiting for an external trigger. "REC" is indicated while the measured value is being recorded. For details, see "LI5655 / LI5660 Instruction Manual (Remote Control)" "5. Description of Commands": TRIGger:SOURce"
UCAL	Indicates the uncalibrated state. Indicated if the calibration information of the product is lost due to a failure and the specified performance cannot be maintained. A failure has occurred, so contact NF Corporation or one of our representatives.

■ Detection Mode Display

If the detection mode is changed, the displayed icon is changed accordingly.

	: SINGLE	Single mode (normal single frequency measurement)
	: DUAL1	Fractional Harmonic mode
	: DUAL2	Independent frequency mode
	: CASCADE	Cascade mode

■ Harmonic Measurement Display

The following describes the screen display for the harmonic setting.

If SINGLE or DUAL1 is set for the detection mode and the HARMONICS setting is enabled, harmonic symbol "n" is added to the end of the measurement parameter.

Furthermore, the harmonic order is displayed next to the synchronous frequency (fundamental wave) display.

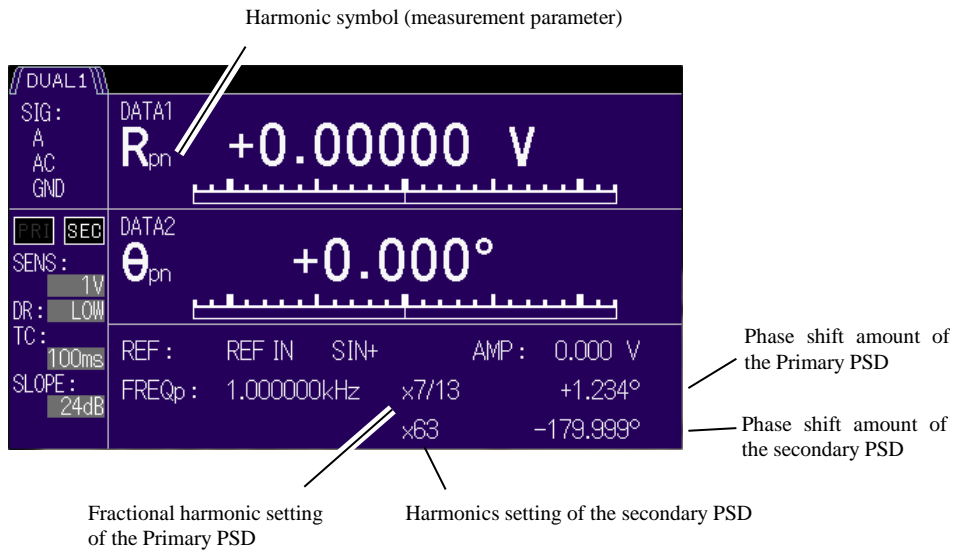

■ Display of Dual-Frequency Display

The following describes the screen display for the harmonic setting.

If the detection mode is DUAL2 or CASCADE, the primary frequency and secondary frequency are displayed.

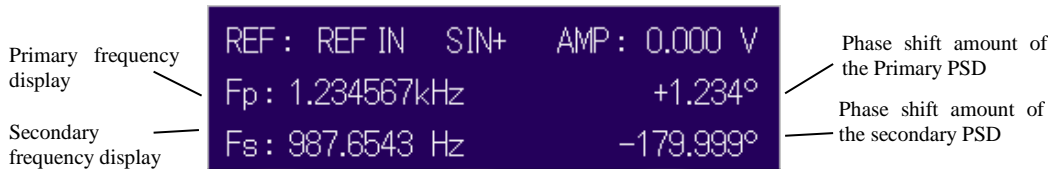

3.3.4 Operations in the Measurement Screen

Some of the parameters can be set as follows even in the measurement screen.

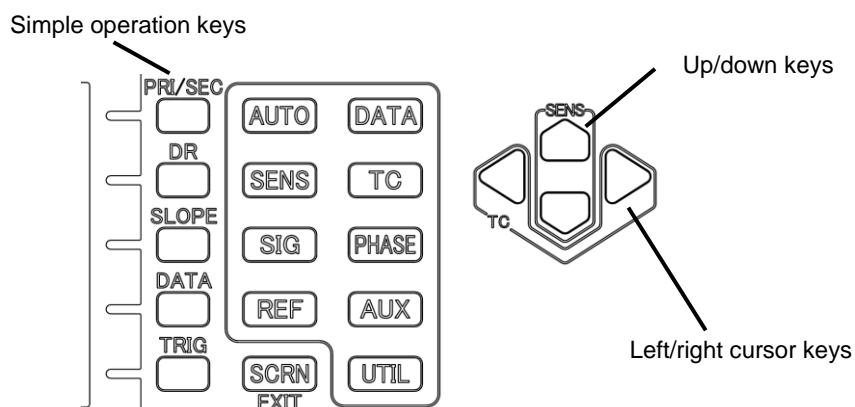

Where to operate	Function
Simple operation keys	
<input type="checkbox"/> / PRI SEC	Select the detector PRI (Primary PSD) → SEC (secondary PSD) → * Can be used only when the detection mode is DUAL1, DUAL2, or CASCADE
<input type="checkbox"/> / DR	Select dynamic reserve (For details, see "4.7 Sensitivity and Dynamic Reserve Setting" LOW → MED → HIGH →
<input type="checkbox"/> / SLOPE	Select the attenuation slope for the time constant filter 6dB → 12dB → 18dB → 24dB →
<input type="checkbox"/> / DATA	Select the DATA1 or DATA2 parameter (For details, see "4.3 Measurement Parameter Setting, Output, and Display") SINGLE (Before change →) R-θ → X-Y → DUAL1 (Before change →) Rpn-θpn → Xpn-Ypn → Xsn-Ysn → Xpn-Xsn → DUAL2 / CASCADE (Before change →) Rp-θp → Xp-Yp → Xs-Ys → Xp-Xs → * DATA3 and DATA4 are not changed.
<input type="checkbox"/> / TRIG	Manual trigger For details, see "LI5655 / LI5660 Instruction Manual (Remote Control)" "5. Description of Commands": TRIGger:SOURce
Up/down keys	Select the sensitivity (SENS)
Left/right cursor keys	Select the time constant (TC)

■ Changing the Sensitivity and Time Constant

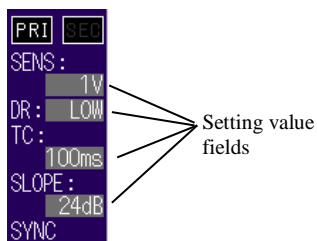

Parameters in the setting value fields of a color different from the background color, such as the sensitivity and time constant, can be set using a simple operation key even in the measurement screen.

3.4 Overview of the Operation Screen

3.4.1 Operation Keys and MODIFY Knob

The advanced settings of the LI5655 / LI5660 are configured in the operation screen.

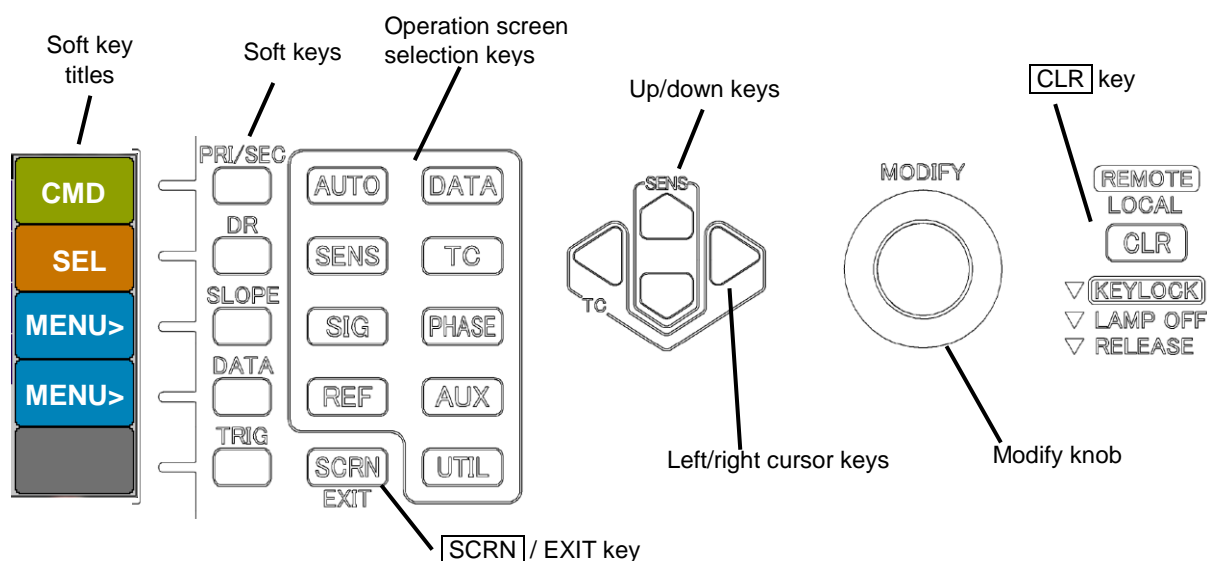

Operation Screen Selection Key

Displays the operation screen for each function.

Press the key to move to the corresponding operation screen (top page).

Soft Key

Operation key whose function changes for each operation screen.

A title indicating the function of each soft key is displayed at the right end of the operation screen.

Left/right cursor keys

Select the digit to change (cursor digit) when entering a multi-digit numerical value.

The cursor does not go farther than the left or right end.

Up/Down Keys / MODIFY Knob

Both have the same function.

Change digits higher than the cursor digit when setting a numerical value.

Switch sequentially between options when selecting one option from multiple options.

CLR Key

Clear the set value.









SCRN / EXIT Key

Go to the next higher-level operation screen or return to the original measurement screen.

Procedure:

- 1) Press the operation screen selection key that includes the function you wish to set.
- 2) Select the soft key where the name of the function you wish to set is displayed.
- 3) Change the parameter using the up/down keys, MODIFY knob, etc.
- 4) Press the **SCRN** / EXIT key to return to the measurement screen.

Operation Screen Selection Key Function List:

Key name	Screen name	Main function
	{ Auto Setting Screen }	Auto setting of the sensitivity, time constant, etc.
	{ Output Signal Setting Screen }	Select the measurement parameter for DATA1 to 4. Specify ratio arithmetic processing, normalize arithmetic processing, etc.
	{ Sensitivity Setting Screen }	Set the sensitivity and dynamic reserve
	{ Time Constant Filter Setting Screen }	Set the time constant, attenuation slope (SLOPE), and synchronous filter (SYNC)
	{ Input Signal Selection Screen }	Select the input connector Select the input coupling Select the signal ground Set the line filter Select the I-V conversion gain for the current input
	{ Phase Adjustment Screen }	Set the phase adjustment range
	{ Reference Signal Setting Screen }	Select the reference signal and polarity Set the frequency and output amplitude of the internal oscillator Set the harmonics (harmonic order, etc.) Set the detection mode
	{ Auxiliary I/O Setting Screen }	Set the AUX IN smoothing Set the AUX OUT voltage
	{ Utility Screen }	Reset the setting Save and recall from the setting memory Set the remote control interface System setting (maintenance, etc.)

3.4.2 Operation Screen Configuration

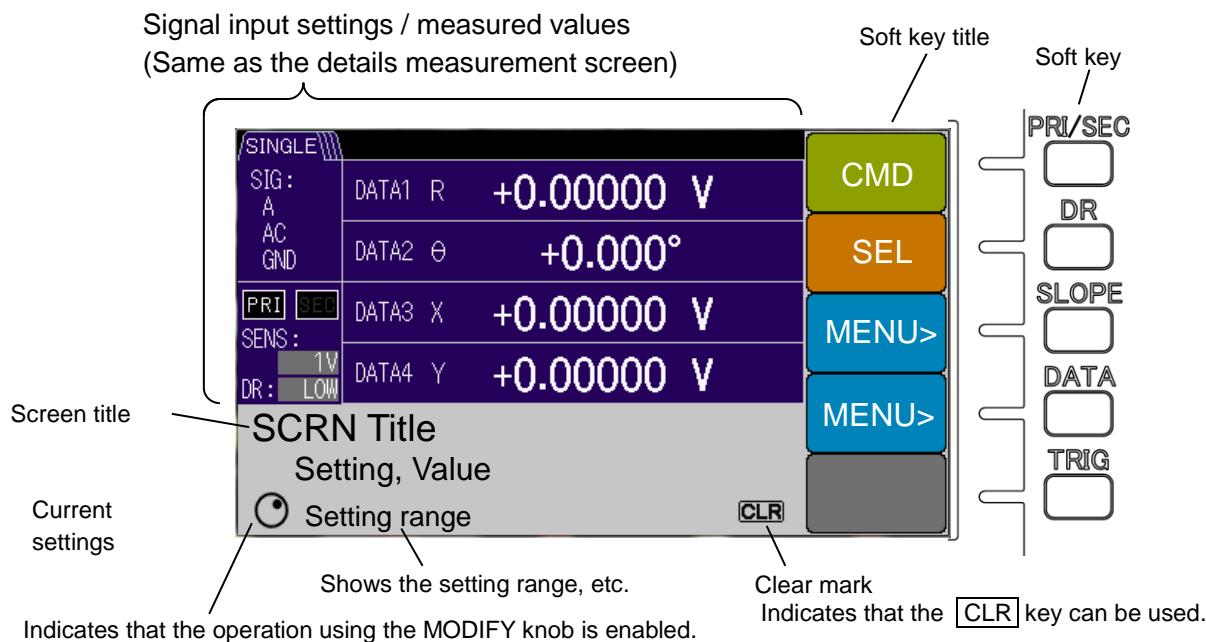

Soft keys are classified into the following types.

Operation Command (CMD)

Execute a particular operation. Execute auto setting, etc.

A vertical bar (" | ") on a key indicates the separation of options. For "ON | OFF" etc., every time the key is pressed, ON and OFF are switched and executed.

Selection (SEL)

Select the setting item. The selected setting item can be changed by moving the cursor in the operation screen and using the up/down keys and MODIFY knob.

A vertical bar (" | ") on a key indicates the separation of options. For "PRI | SEC" etc., every time the key is pressed, PRI and SEC are switched and selected.

Movement to a Lower-Level Screen (MENU>)

If ">" is at the end of the soft key name, you can move to a related lower-level operation screen.

Clear Mark

- **CLR** : Clear the entire string that was entered.
- **CLR⇨** : When entering a multi-digit numerical value, the digits lower than the cursor position are set to 0.

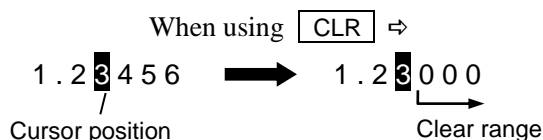

Note that soft key titles CMD, SEL, and MENU> are examples for explanation. They differ from the titles that are actually displayed.

3.5 Operation Tree

The following shows the operation tree for operating the LI5655/ LI5660 from the panel.

For key and screen notations, refer to "3.1 Panel Part Names and Operations".

*1: This symbol indicates that the tree is omitted because the lower-level operation tree is the same as that of detection mode SINGLE.

*2: This symbol indicates that the tree is omitted because the lower-level operation tree is the same as that of detection mode DUAL1.

For details, refer to "3.5.2 Operation Tree in the Measurement Screen (SINGLE)"
 "3.5.3 Operation Tree in the Operation Screen (DUAL1)"
 "3.5.4 Operation Tree in the Operation Screen (DUAL2/CASCADE)"

3.5.1 Operation Tree in the Measurement Screen

Front Panel

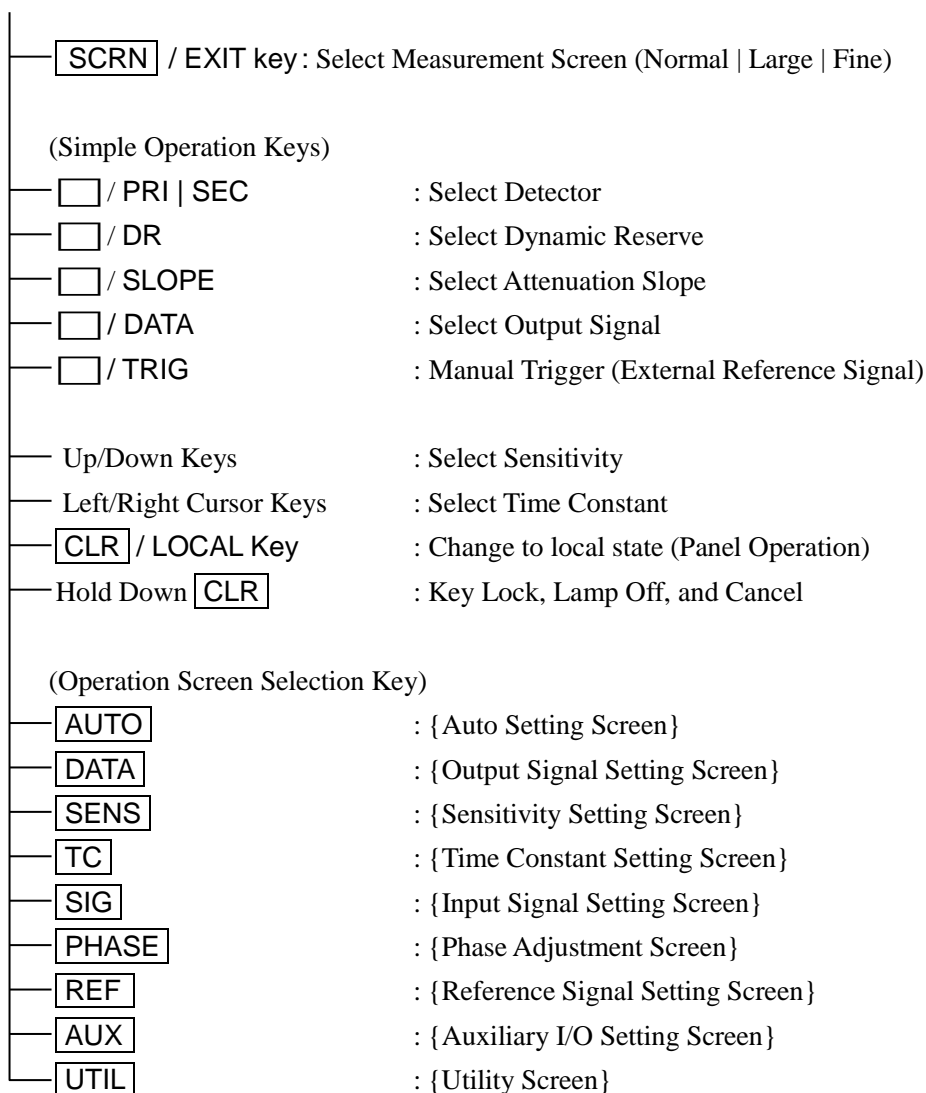

3.5.2 Operation Tree in the Measurement Screen (SINGLE)

The following shows the operation tree when the detection mode is SINGLE (normal single frequency)

(Operation Screen Selection Key)

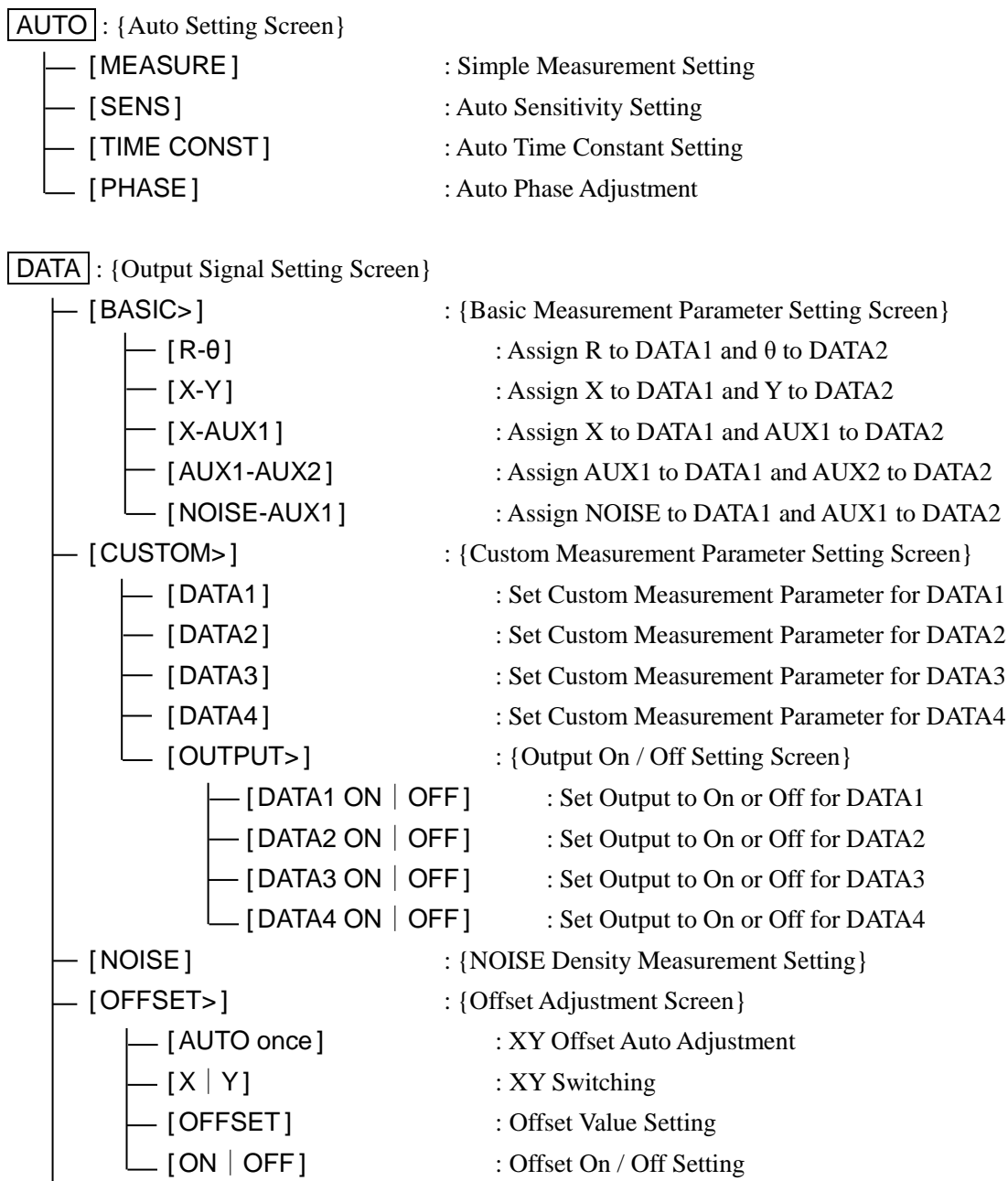

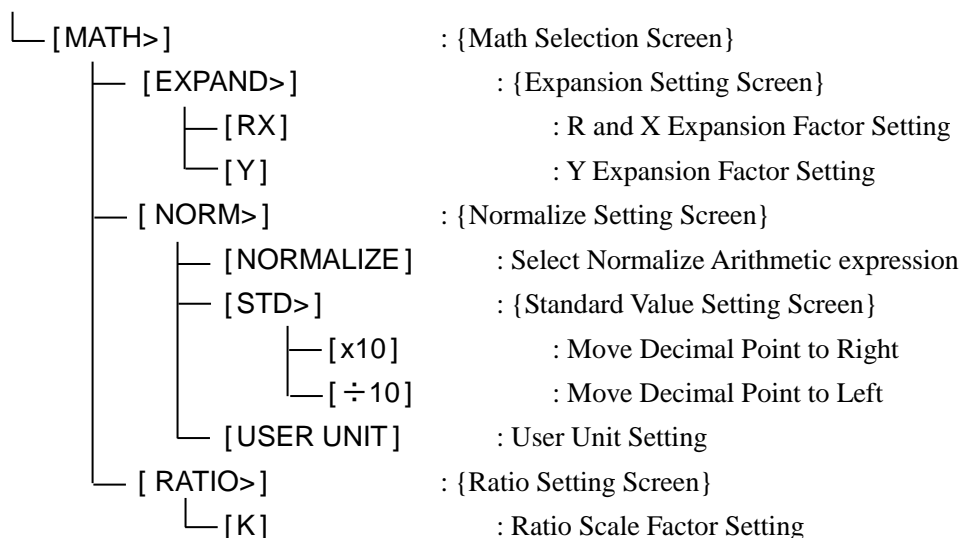

SENS : {Sensitivity Setting Screen}

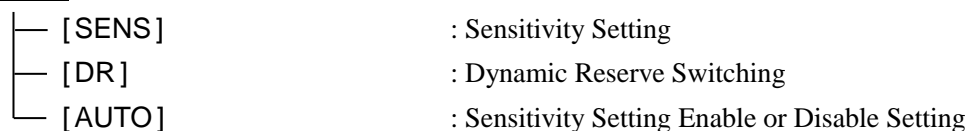

TC : {Time Constant Filter Setting Screen}

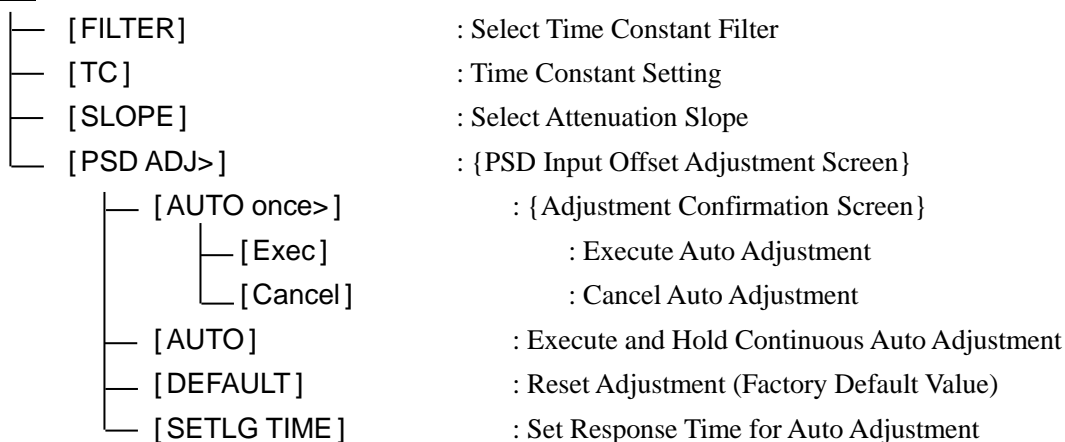

SIG : {Input Signal Selection Screen}

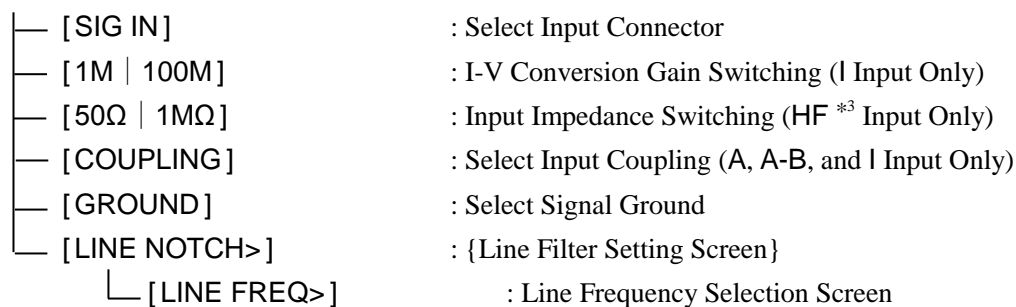

*3: Only the LI5660 is equipped with the HF input.

PHASE : {Phase Adjustment Screen}

- [+90°R] : Phase Shift Amount 90° Increase
- [-90°R] : Phase Shift Amount 90° Decrease
- [ZERO] : Set Phase Shift Amount to 0°

REF : {Reference Signal Setting Screen}

- [SOURCE] : Select Reference Signal Source
- [EDGE] : Select Reference Signal Waveform
- [OSC SET>] : {Oscillator Setting Screen}
 - [FREQ>] : {Frequency Setting Screen}
 - [x10] : Move Decimal Point to Right for Frequency
 - [÷10] : Move Decimal Point to Left for Frequency
 - [AMPTD>] : {Amplitude Setting Screen}
 - [AMPTD>] : Amplitude Setting
 - [x10] : Move Decimal Point to Right for Amplitude
 - [÷10] : Move Decimal Point to Left for Amplitude
 - [RANGE] : Amplitude Range Setting
 - [10MHz In>] : {External 10 MHz Setting Screen}
 - [ON | OFF] : 10 MHz Enable or Disable
- [HMNC>] : {Harmonic Setting Screen}
 - [ON | OFF] : Harmonic On / Off
 - [n] : n-order Harmonic Setting
 - [m] : 1/m Fractional Harmonic Setting
- [DET MODE>] : {Detection Mode Setting Screen}
 - [Exec] : Execute Detection Mode Setting
 - [Cancel] : Cancel Detection Mode Setting

AUX : {Auxiliary I/O Setting Screen}

- [AUX IN>] : {Auxiliary Input Setting Screen}
 - [IN1] : Select AUX IN1 Smoothing Time Constant
 - [IN2] : Select AUX IN2 Smoothing Time Constant
 - [INPUT>] : {AUX IN Setting Screen}
 - [AUX IN1 ON | OFF] : AUX IN1 On / Off
 - [AUX IN2 ON | OFF] : AUX IN2 On / Off
- [AUX OUT>] : {Auxiliary Output Setting Screen}
 - [OUT1] : AUX OUT1 Voltage Setting
 - [OUT2] : AUX OUT2 Voltage Setting

To be continued

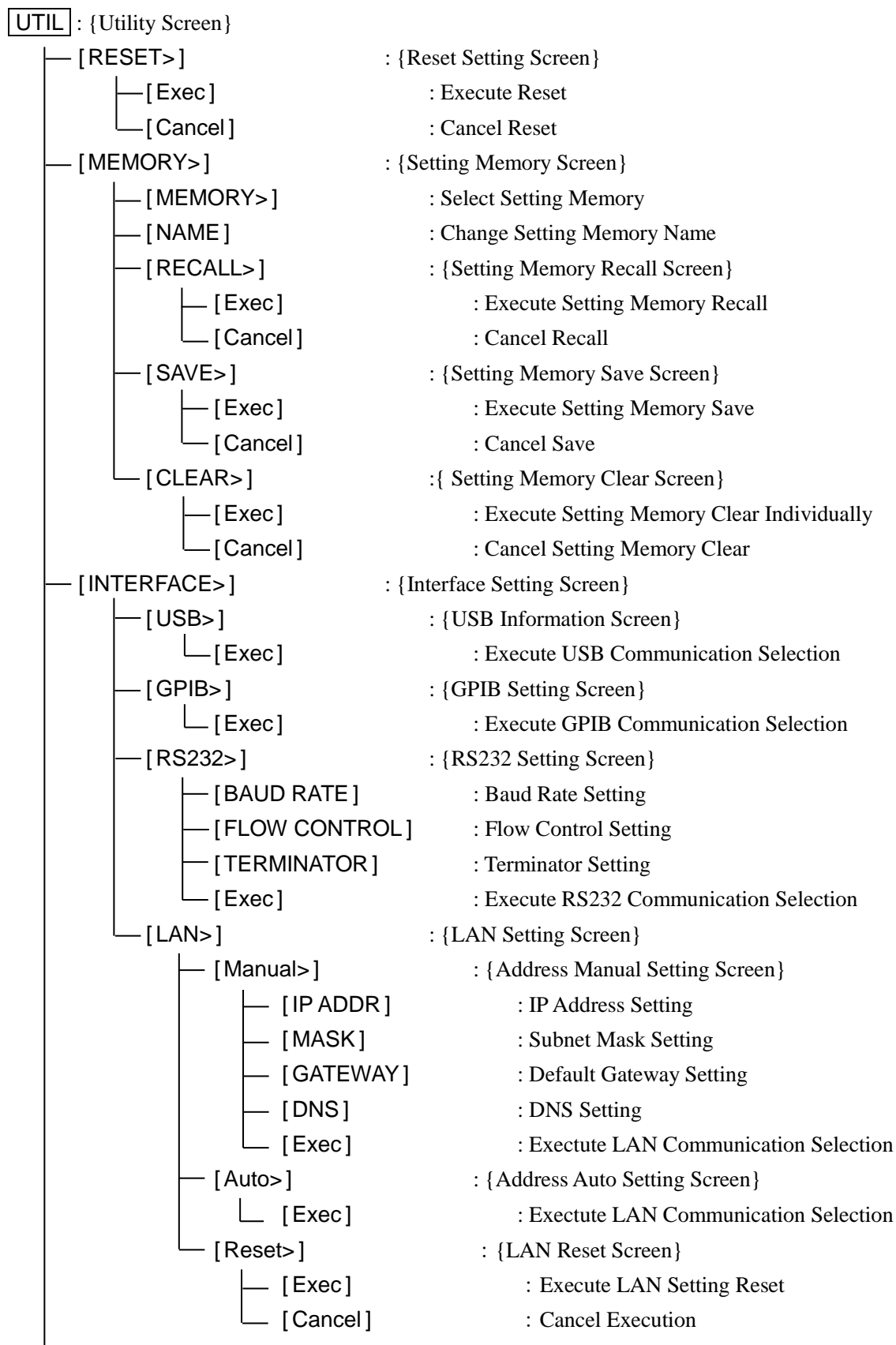

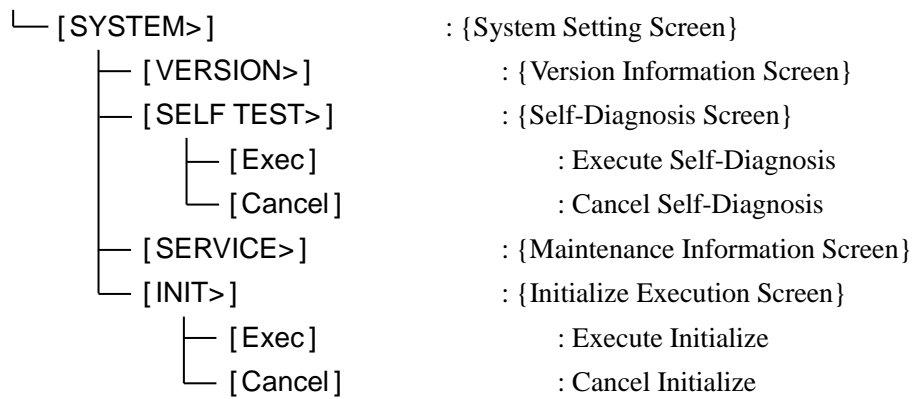

(Other Operations)

Front Panel

MODIFY Knob

Select the parameter or change the numerical value higher than the cursor digit (digit on which the cursor is placed)

Up/down keys

Same as the MODIFY knob

Left/right cursor keys

Move the cursor to enter a multi-digit numerical value

CLR

Clear a numerical value, string, etc.

SCRN / EXIT

Move to a higher level setting screen or return to the original measurement screen

3.5.3 Operation Tree in the Operation Screen (DUAL1)

The following shows the operation tree when the detection mode is DUAL1 (fractional harmonic mode)

(Operation Screen Selection Key)

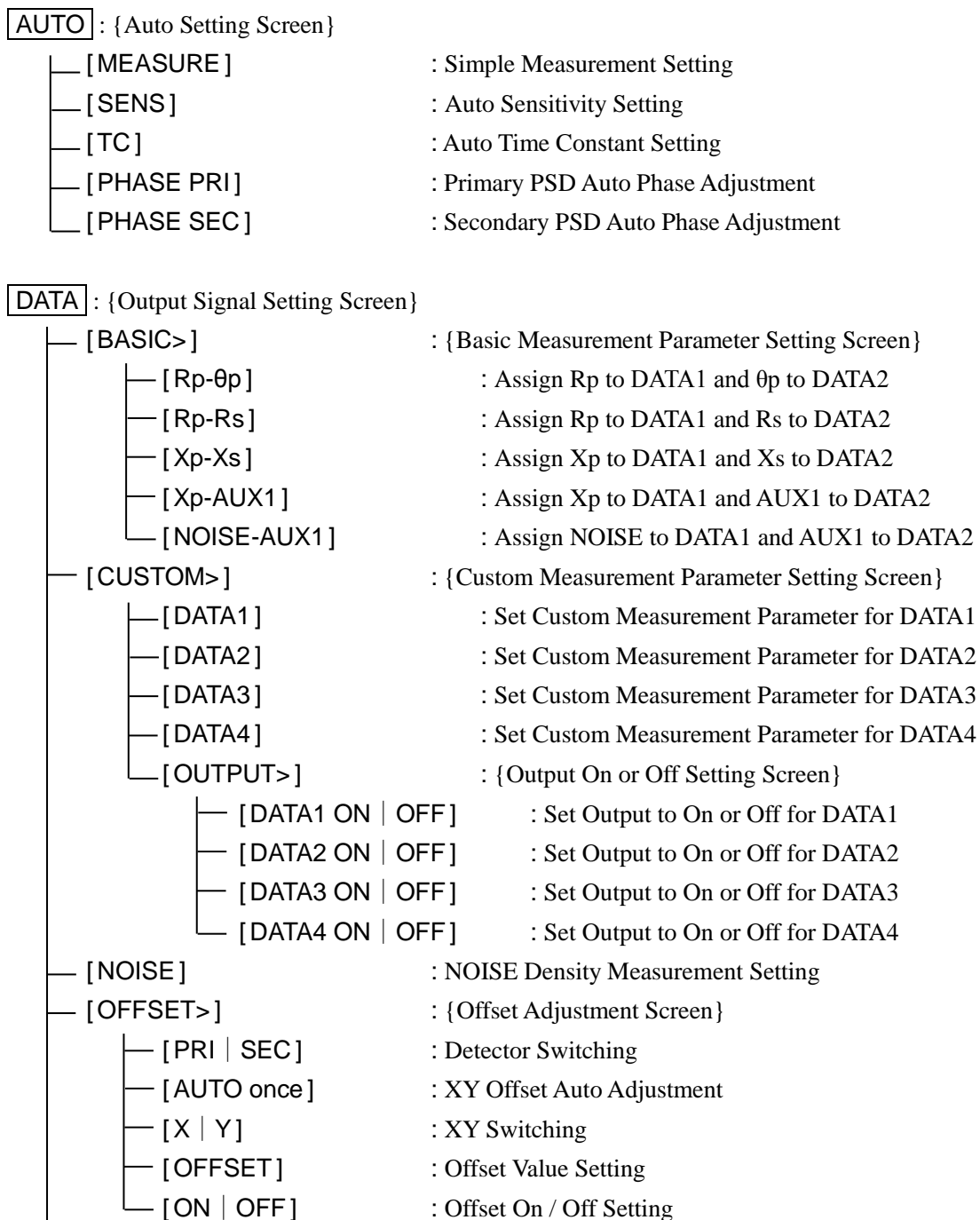

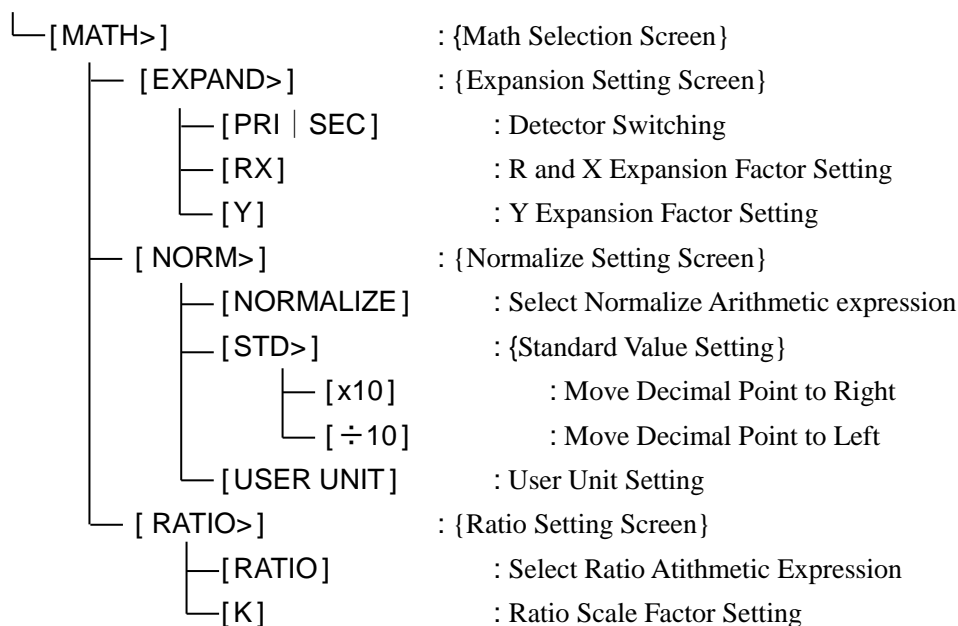

SENS : {Sensitivity Setting Screen}

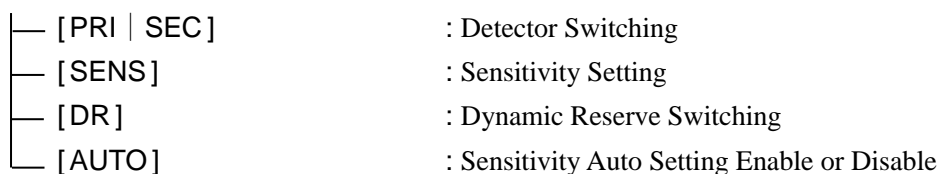

TC : {Time Constant Filter Setting Screen}

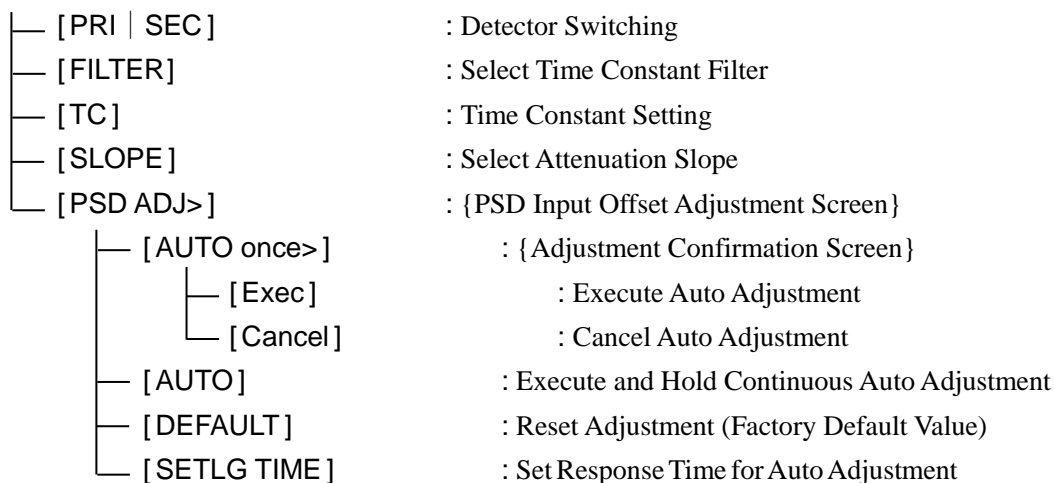

SIG : {Input Signal Selection Screen}*¹

PHASE : {Phase Adjustment Screen}

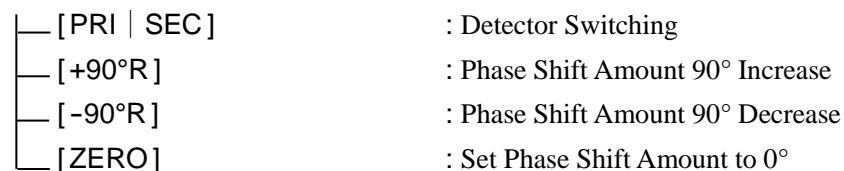

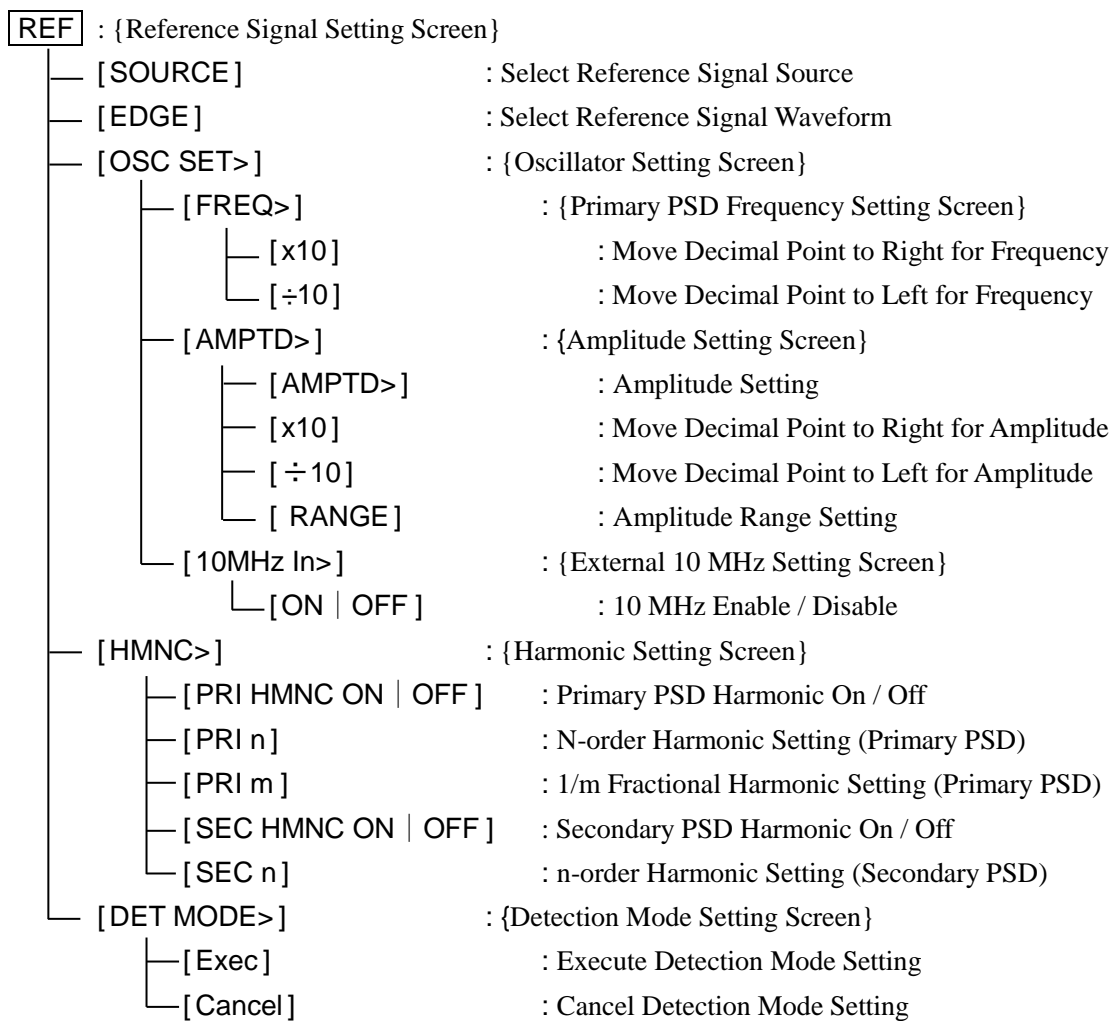

AUX : {Auxiliary I/O Setting Screen}*¹

UTIL : {Utility Screen}*¹

(Other Operations)

Front Panel *¹

3.5.4 Operation Tree in the Operation Screen (DUAL2/CASCADE)

The following shows the operation tree when the detection mode is DUAL2 (independent frequency mode) and CASCADE (cascade mode).

(Operation Screen Selection Keys)

AUTO : {Auto Setting Screen} *2

DATA : {Output Signal Setting Screen} *2

SENS : {Sensitivity Setting Screen} *2

TC : {Time Constant Filter Setting Screen} *2

SIG : {Input Signal Selection Screen} *1

PHASE : {Phase Adjustment Screen} *2

REF : {Reference Signal Setting Screen}

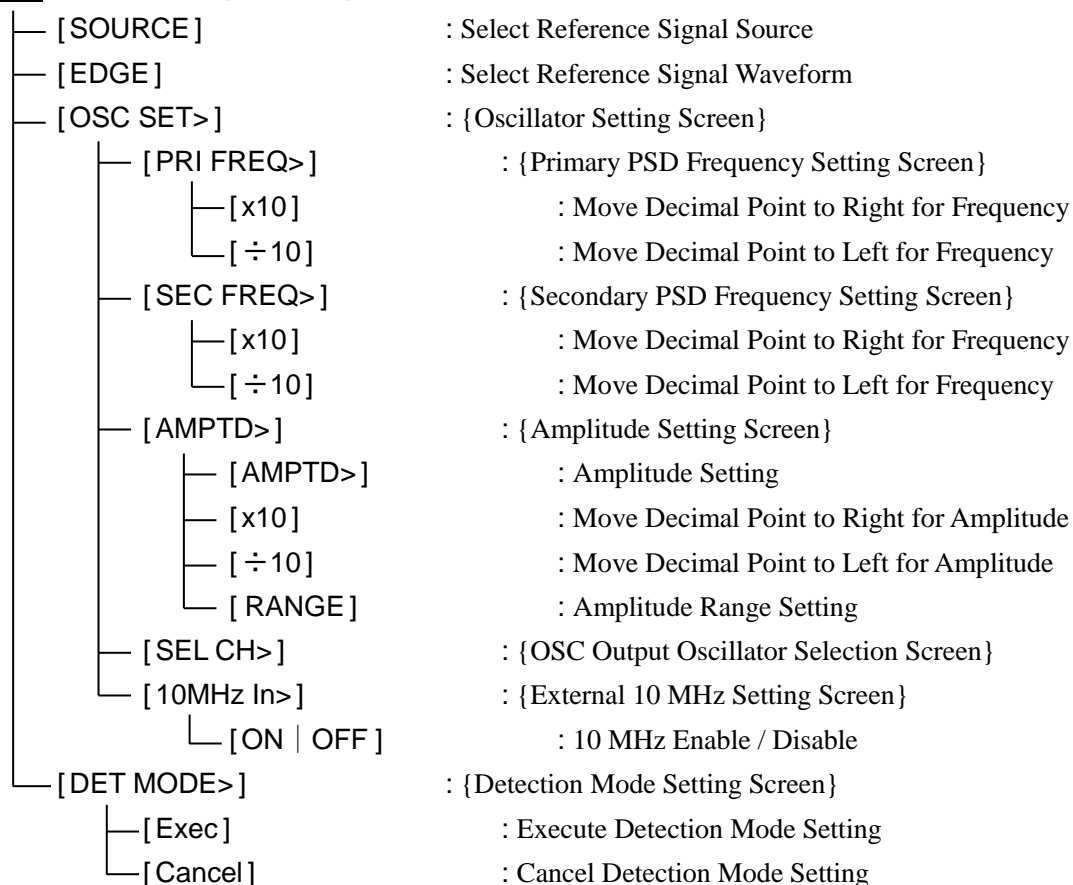

AUX : {Auxiliary I/O Setting Screen}*¹

UTIL : {Utility Screen}*¹

(Other Operations)

Front Panel *¹

3.6 Operation Screen Reference

The following shows each operation screen.

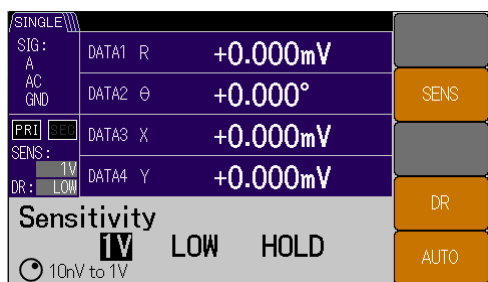

《Single Frequency Measurement》

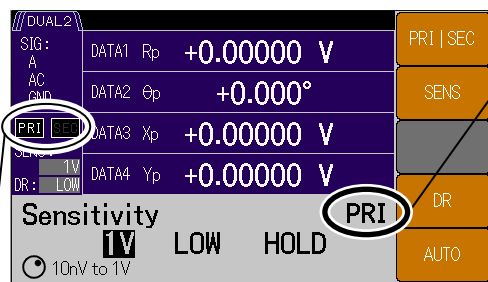

《Dual Frequency Measurement_PRI》

Detector icon

Detector switching soft key

Detector display

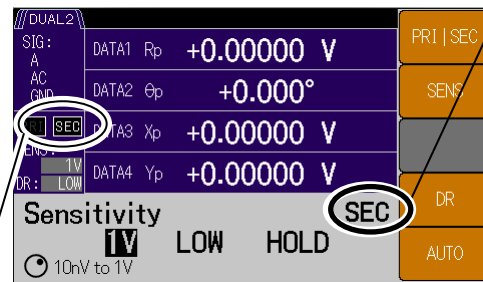

《Dual Frequency Measurement_SEC》

Detector display

Detector icon

■ Soft Key Displayed for the Frequency Constant Setting

[PRI | SEC]

This soft key is not displayed when the detection mode is SINGLE, but is displayed when the detection mode is DUAL1, DUAL2, or CASCADE.

If the operation screen is **SENS**, **TC**, or **PHASE** and the TOP menu is displayed, the detector to be set can be switched to PRI (Primary PSD) or SEC (Secondary PSD).

You can identify which detector is selected by the detector icon ("PRI" or "SEC") on the setting screen.

3.6.1 **AUTO** : {Auto Setting Screen}

When you enter this screen, it switches to the auto setting screen.

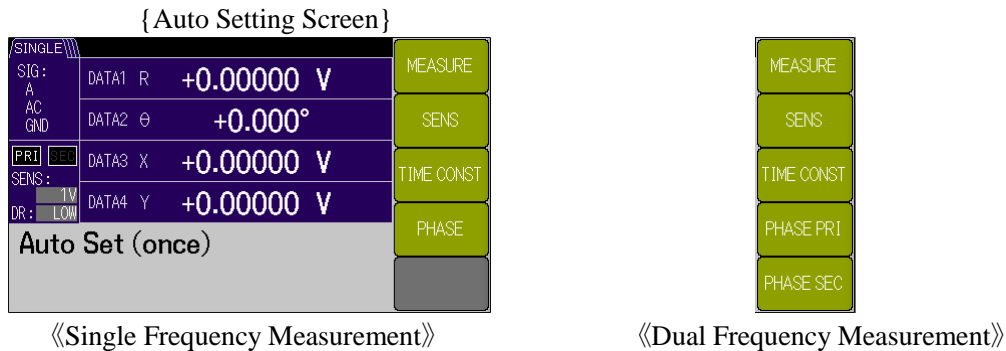

[MEASURE]: Simple Measurement Setting

Execute the simple measurement setting.

Execute the auto setting in order of TIME CONST → SENS → PHASE PRI below.

For the dual frequency measurement, the setting is executed in order of PHASE SEC → PHASE PRI.

[SENS]: Auto Sensitivity Setting

Execute the auto sensitivity setting. For details, see "4.7 Sensitivity and Dynamic Reserve Setting"

Adjust the sensitivity (SENS) and dynamic reserve (DR) according to the magnitude of the signal and noise.

The dynamic reserve setting is shared by the primary and secondary PSD in the dual frequency measurement.

[TIME CONST]: Auto Time Constant Setting

Execute the auto time constant filter setting. For details, see "4.6 Time Constant Filter Setting and Characteristics"

Set the time constant (TC) and attenuation slope (SLOPE) according to the frequency of the reference signal.

If the synchronous filter function (SYNC: integer period moving average filter) is set to On, it is canceled.

[PHASE]: Auto Phase Adjustment

For dual frequency measurement, the key name is [PHASE PRI].

Execute the auto phase adjustment. For details, see "4.8 Phase Adjustment"

Set the phase shift amount for the reference signal to be provided for PSD so the Y and θ output become zero.

[PHASE SEC]: Auto Phase Adjustment

For single frequency measurement, this soft key is not displayed.

For dual frequency measurement, auto phase adjustment of the secondary PSD is executed.

Operation Message

When the auto setting is completed, "Done" is displayed for a short time and then the screen returns to the measurement screen.

When the process is interrupted (canceled), "Canceled" is displayed.

When the following operations is performed, Simple measurement setting and sensitivity setting, It will be forcibly canceled.

- When the offset value is changed using the **DATA** key and [OFFSET>] soft key.
- When the arithmetic processing function is changed using the **DATA** key and [MATH>] soft key.
- When a change is made to the time constant filter settings using the **TC** key.
- When a change is made to the input connector settings using the **SIG** key.
- When the phase shift amount is changed using the **PHASE** key.
- When a change is made to the reference signal settings using the **REF** key.
- When the sensitivity or dynamic reserve is changed from the measurement screen or operation screen.

Error Message

If the auto setting fails, "Error" and an error message are displayed.

"Error No.-206 Auto-once failed duo to unlock"

The auto setting failed because the signal is not synchronized with the reference signal (REF IN, SIGNAL).

3.6.2 **DATA**: {Output Signal Setting Screen}

When you enter this setting screen, you can set the measurement parameters for DATA1 to DATA4.

[BASIC>]: {Basic Measurement Parameter Setting Screen}

Pressing this soft key switches the soft key display to a frequently used combination of measurement parameters (refer to the figure below). When the switched soft key is executed, values are set in DATA1 and DATA2 at one time. DATA3 and DATA4 are not changed.

Combinations of basic measurement parameters are shown in the tables below.

For example, if [X-Y] is executed in single frequency measurement, measurement parameters X and Y are set in DATA1 and DATA2, respectively.

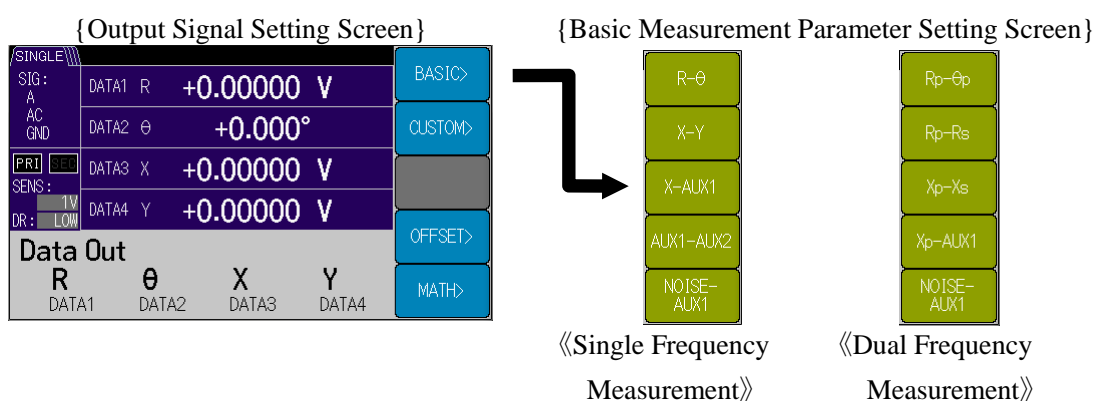

《Combinations for Single Frequency Measurement》

Soft key	Measurement parameter			
	DATA1	DATA2	DATA3	DATA4
[R-θ]	R	θ	No Change	No Change
[X-Y]	X	Y	No Change	No Change
[X-AUX1]	X	AUX1	No Change	No Change
[AUX1-AUX2]	AUX1	AUX2	No Change	No Change
[NOISE-AUX1]	NOISE	AUX1	No Change	No Change

《Combinations for Dual Frequency Measurement》

Soft key	Measurement parameter			
	DATA1	DATA2	DATA3	DATA4
[Rp-θp]	Rp	θp	No Change	No Change
[Rp-Rs]	Rp	Rs	No Change	No Change
[Xp-Xs]	Xp	Xs	No Change	No Change
[Xp-AUX1]	Xp	AUX1	No Change	No Change
[NOISE-AUX1]	NOISE	AUX1	No Change	No Change

Measurement parameter symbols

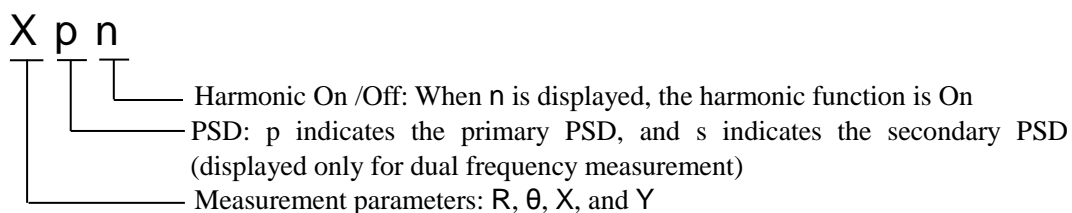

[CUSTOM>]: {Custom Measurement Parameter Setting Screen}

Pressing this soft key switches the soft key from DATA1 to DATA4.

An individual parameter can be set in each DATA.

Parameters that can be set individually are shown in the tables below.

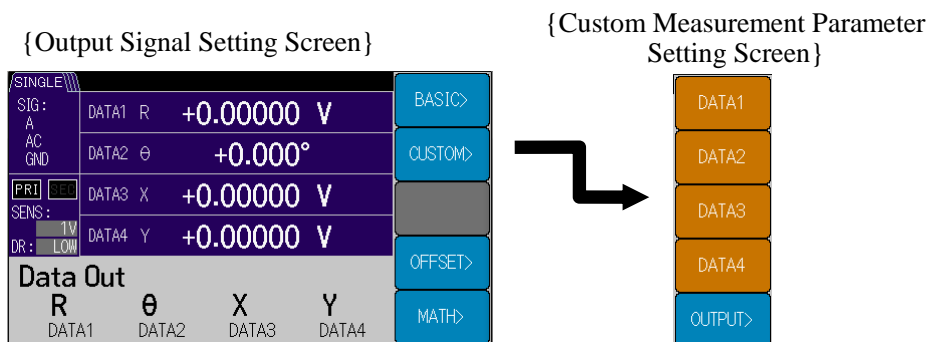

《Measurement Parameters for Single Frequency Measurement》

Soft key	Measurement parameter
[DATA1]	X R AUX1 NOISE
[DATA2]	Y θ AUX1 AUX2
[DATA3]	X R
[DATA4]	Y θ

《Measurement Parameters for Dual Frequency Measurement》

Soft key	Measurement parameter
[DATA1]	Xp Rp Yp θp Xs Rs AUX1 NOISE
[DATA2]	Yp θp Xs Rs Ys θs AUX1 AUX2
[DATA3]	Xp Rp Yp θp Xs Rs
[DATA4]	Yp θp Xs Rs Ys θs

[OUTPUT>]: {Output On / Off Setting Screen}

Pressing this soft key switches the voltage output for DATA1 to DATA4 individually to ON (enable) and OFF (disable).

{Custom Measurement Parameter Setting Screen}

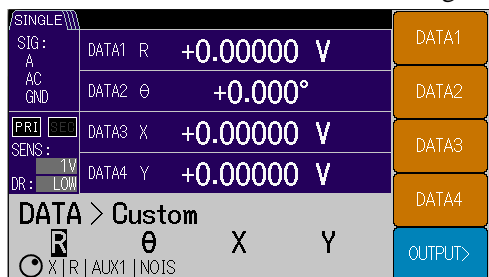

{Output On / Off Setting Screen}

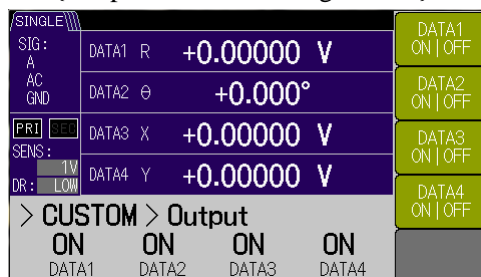

■ Stopping the DATA OUT Output Connector

If Output ON / OFF is set to OFF (disable), the DATA OUT output is stopped (about 0 V) while the measured value on the screen remains unchanged. The clock for the internal D/A converter stops so noise (disturbance) is reduced and very small signal measurement is more immune to disturbance.

[NOISE]: NOISE Density Measurement Setting

When NOISE is selected for the measurement parameter, this soft key is displayed.

This soft key allows you to set the noise smoothing factor. The setting range is {1 | 4 | 16 | 64}. The larger the factor, the smaller the fluctuation of the measured value (which is proportional to the smoothing factor), but it will take some time for the value to become stabilized.

{Output Signal Setting Screen}



[OFFSET>]: {Offset Adjustment Screen}

Pressing this soft key switches to {Offset Adjustment Screen}.

When you enter this setting screen, you can move through the digits using the left/right cursor keys and then set the offset value using the MODIFY knob and up/down keys.

The offset value can be set individually for measurement parameters X and Y for each detector.

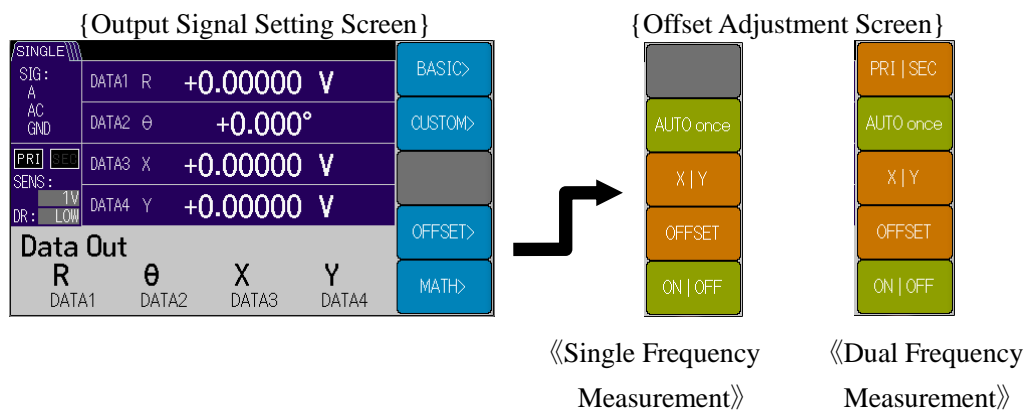

[PRI | SEC]: Detector Switching

For single frequency measurement, this soft key is not displayed.

For dual frequency measurement, the offset value can be set individually for measurement parameters X and Y for each detector.

[AUTO once]: XY Offset Auto Adjustment

The offset is automatically adjusted once to set both measurement parameters X and Y to zero.

When the offset auto adjustment is executed, the offset ON / OFF setting is set to ON.

[X | Y]: XY Switching

Measurement parameters X and Y for setting the offset are switched.

[OFFSET]: Offset Value Setting

The cursor moves and the offset value can be set.

The setting range is { -105.000% to +105.000% }

[ON | OFF]: Offset ON / OFF Setting

The offset setting for measurement parameters X and Y is individually switched between ON (enable) and OFF (disable).

Operation Message

When the auto adjustment is completed successfully, "Done" is displayed after the offset adjustment value for a short time.

Error Message

If the auto setting fails, "Error" and an error message are displayed.

"Error No.-206 Auto-once failed duo to unlock"

The auto adjustment failed because the signal is not synchronized with the reference signal (REF IN, SIGNAL).

"Error No.-207 X,Y out of range"

The auto adjustment failed because the X and Y measured values are outside the adjustment range.

[MATH>]: {Math Selection Screen}

Pressing this soft key allows you to select from the arithmetic processing functions {OFF | EXPAND | NORMALIZE | RATIO} for measurement parameters X, Y, and R.

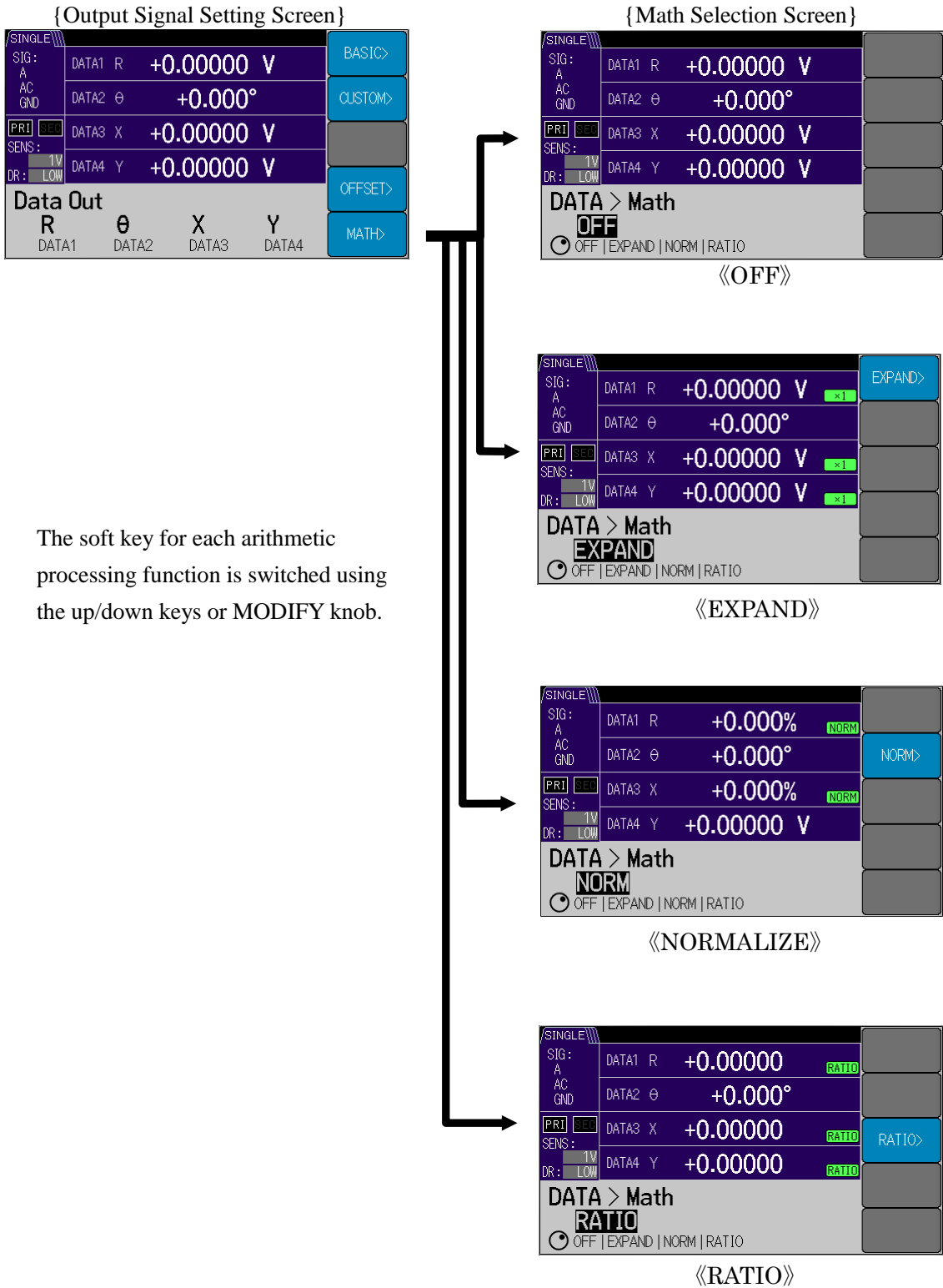

The soft key for each arithmetic processing function is switched using the up/down keys or MODIFY knob.

During each arithmetic function, When you press the [MEASURE] soft key or the [SENS] soft key of the **AUTO** key {Auto Setting Screen} or the [AUTO] soft key of the **SENS** key {Sensitivity Setting Screen}, the arithmetic processing function is canceled.

[EXPAND>]: {Expansion Setting Screen}

When EXPAND is selected for the arithmetic processing function, the screen is switched to {Expansion Setting Screen}.

A common expansion scale can be set for X and R, and an individual expansion scale can be set for Y.

Disabling EXPAND is equivalent to expansion factor 1.

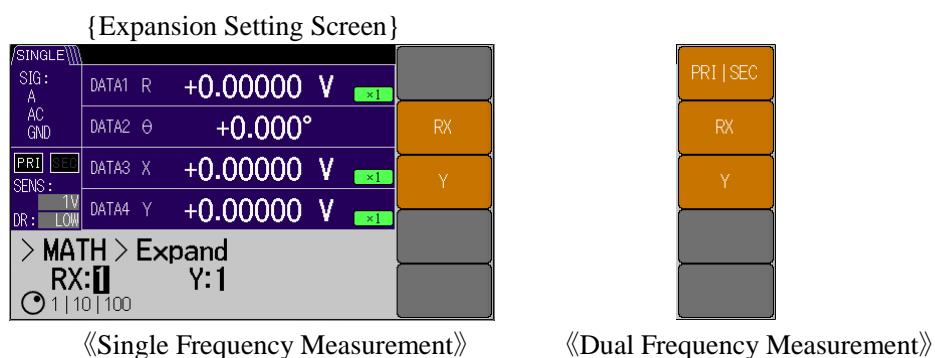

[PRI | SEC]: Detector Switching

For single frequency measurement, this soft key is not displayed.

For dual frequency measurement, an expansion factor can be set individually for measurement parameters R, X, and Y for each detector.

[RX]: R and X Expansion Factor Setting

Factors {1 | 10 | 100} can be set for measurement parameters R and X.

[Y]: Y Expand Setting

Factors {1 | 10 | 100} can be set for measurement parameter Y.

[NORMALIZE >]: {Normalize Setting Screen}

When NORMALIZE is selected for the arithmetic processing function, the screen is switched to {Normalize Setting Screen}.

A normalize arithmetic processing is performed for the measured value for the primary PSD measurement parameter X or R set for DATA1, and the result is displayed and output for DATA1.

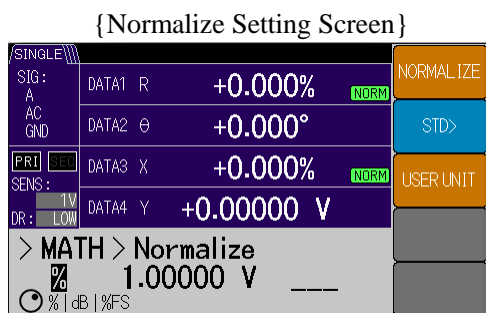

[NORMALIZE]: Select Normalize Arithmetic Expression

Normalize arithmetic expression can be selected from { % | dB | %FS }

- % : (Measured value ÷ standard value) x 100 [%]
- dB : $20 \times \log_{10}$ (Measured value ÷ standard value) [dB]
- %FS : (Measured value ÷ sensitivity setting) x 100 [%FS]

[STD>]: {Standard Value Setting Screen}

Pressing this soft key switches to {Standard Value Setting Screen}, where you can set the standard value by moving the cursor.

The setting range of the standard value is { 1 nV to 10 V for voltage measurement and 1 fA to 1 μA for current measurement (6-digit resolution) }.

[×10] : Move Decimal Point to Right

You can move the decimal point in the standard value to the right.

[÷10] : Move Decimal Point to Left

You can move the decimal point in the standard value to the left.

[USER UNIT]: User Unit Setting

Pressing this soft key allows you to set the user unit string by moving the cursor.

Up to 3 characters can be selected from { Blank, A to Z, a to z, 0 to 9, #, @, - } and specified for the user unit string to be added after the numerical value. (Example: "USR")

[RATIO >] : {Ratio Setting Screen}

When RATIO is selected for the arithmetic processing function, the screen is switched to {Ratio Setting Screen}.

A ratio arithmetic processing is performed using the measured value of primary PSD measurement parameter Xp, Yp, or Rp as the numerator and the measured value of auxiliary input AUX IN1 or secondary PSD measurement parameter Xs as the denominator.

The ratio can be displayed and output by selecting the primary PDS measurement parameter Xp, Yp, or Rp for DATA in the state of execution of the ratio arithmetic processing.

When you enter this setting screen, you can move through the digits using the left/right cursor keys and then set the ratio scale using the MODIFY knob and up/down keys.

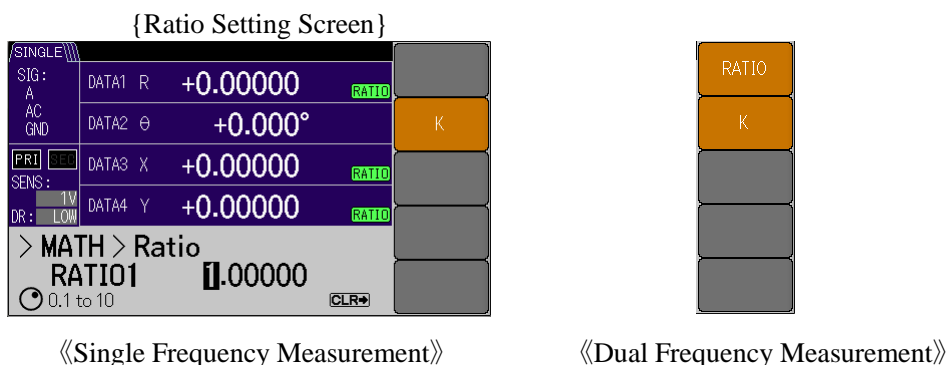

[RATIO] : Select Ratio Arithmetic Processing Function

You can select the ratio arithmetic expression from {RATIO1 | RATIO2}.

However, RATIO2 can be displayed and selected only when the detection mode is DUAL1 or DUAL2.

RATIO selection	Contents of arithmetic expression	Detection mode
RATIO1	$K \times (\text{primary PSD } (X_p, Y_p, R_p) \div \text{AUX IN1}) \quad [\%FS]$	SINGLE DUAL1 DUAL2
	$K \times (\text{secondary PSD } (X_s, Y_s, R_s) \div \text{AUX IN1}) \quad [\%FS]$	CASCADE
RATIO2	$K \times (\text{primary PSD } (X_p, Y_p, R_p) \div \text{secondary PSD } X_s) \quad [\%FS]$	DUAL1 DUAL2

[K] : Ratio Scale Factor Setting

Pressing this soft key allows you to set the ratio scale by moving the cursor.

The setting range of the ratio scale is {0.1 to 10 (6-digit resolution)}.

3.6.3 [SENS] : {Sensitivity Setting Screen}

When you enter this setting screen, you can adjust SENS (sensitivity) using the MODIFY knob and up/down keys.

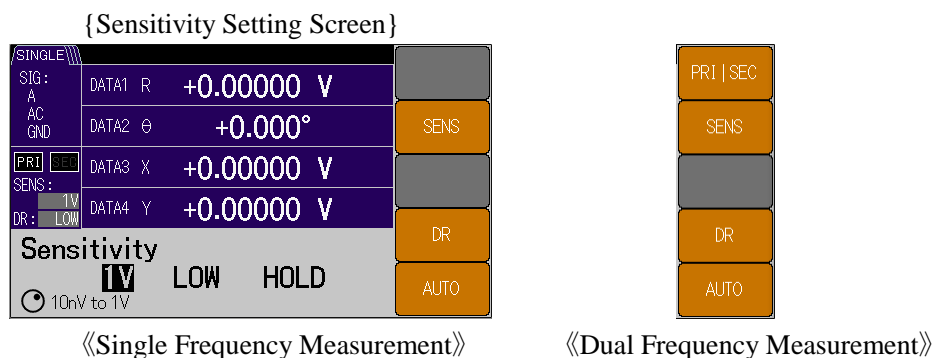

[PRI | SEC] : Detector Switching

For single frequency measurement, this soft key is not displayed.

For dual frequency measurement, the sensitivity can be set individually for the primary and secondary PSD's.

[SENS] : Sensitivity Setting

The sensitivity can be set.

[DR] : Dynamic Reserve

The dynamic reserve can be selected from {LOW | MED | HIGH}.

[AUTO] : Sensitivity Auto Setting

You can select whether to continuously automatically adjust or hold the sensitivity and dynamic reserve by selecting {AUTO | HOLD} according to the magnitude of the signal and noise.

If you press the [MEASURE] soft key or [SENS] soft key of the [AUTO] key {Auto Setting Screen} during the continuous automatically adjustment, the continuous automatically adjustment will be canceled.

3.6.4 [TC] : {Time Constant Filter Setting Screen}

When you enter this setting screen, you can set TC (time constant) using the MODIFY knob and up/down keys.

{Time Constant Filter Setting Screen}

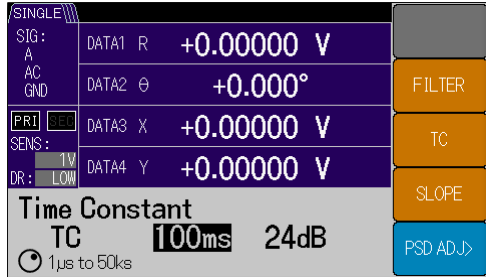

《Single Frequency Measurement》



《Dual Frequency Measurement》

[FILTER] : Select Filter

For single frequency measurement, this soft key is not displayed.

For dual frequency measurement, the time constant filter can be set individually for the primary and secondary PSD's.

[FILTER] : Select Filter

The filter after the detector can be selected from {TC | SYNC}.

- TC : Time constant filter only
- SYNC : Synchronous filter + time constant filter

[TC] : Time Constant Setting

The time constant can be set to {1 μs to 50 ks (1-2-5 sequence)}.

[SLOPE] : Attenuation Slope Setting

The attenuation slope can be set to {6 dB | 12 dB | 18 dB | 24 dB}.

[PSD ADJ>] : {PSD Input Offset Adjustment Screen}

Pressing this soft key switches to {PSD Input Offset Adjustment Screen} to cancel the input offset for PSD (phase sensitive detector).

For details, refer to "5.7 PSD Input Offset Adjustment"

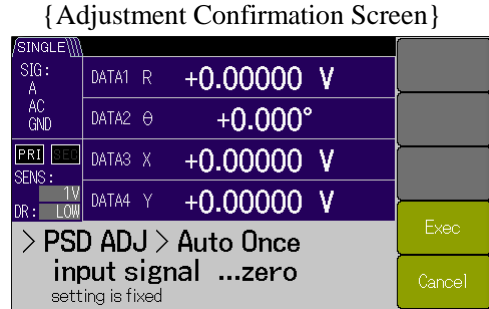
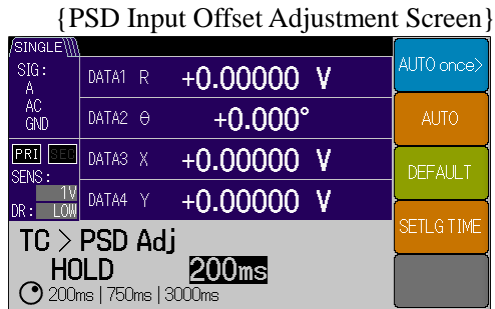

[AUTO once>] : {Adjustment Confirmation Screen}

Automatically adjusts the PSD input offset only once.

Pressing this soft key switches to {Adjustment Confirmation Screen}.

[Exec] : Execute Auto Adjustment

Executes the adjustment.

After the adjustment is completed, HOLD is set.

[Cancel] : Cancel Auto Adjustment

Returns to the PSD adjustment screen without executing the adjustment.

[AUTO] : Execute and Hold Continuous Auto Adjustment

{AUTO | HOLD} can be set for the continuous auto PSD input offset adjustment.

If HOLD is set, the last PSD input offset adjustment value is applied.

If AUTO is set, the PSD input offset is continuous automatically adjusted.

[DEFAULT] : Reset Adjustment (Factory Default Value)

Resets the PSD adjustment value (to the factory default value).

[SETLG TIME] : Set Response Time for Auto Adjustment

The time constant for the auto PSD input offset adjustment can be selected from {200 ms | 750 ms | 3000 ms}.

3.6.5 [SIG] : {Input Signal Selection Screen}

When you enter this setting screen, you can select the input connector using the MODIFY knob and up/down keys.

*1: Only the LI5660 is equipped with the C and HF inputs.

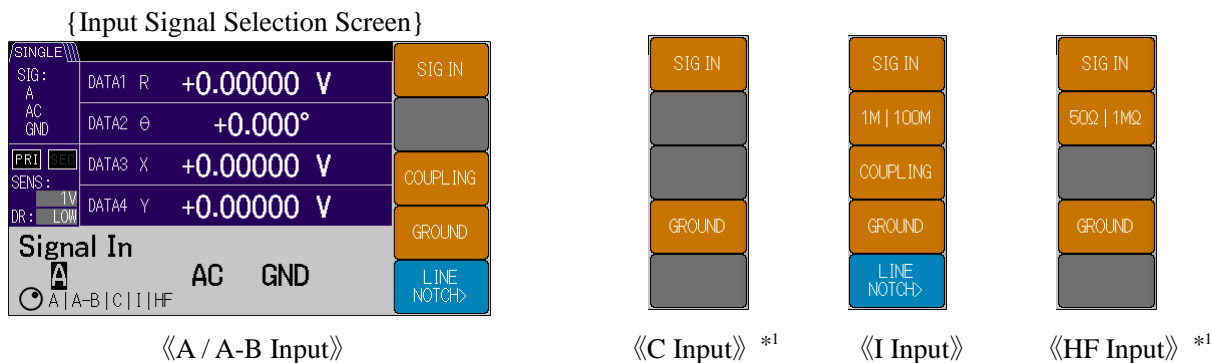

[SIG IN] : Select Input Signal

Pressing this soft key allows you to select the input connector from {A | A-B | C *1 | I | HF *1}.

Furthermore, the soft key for a parameter that can be set is displayed according to the selected input.

[1M | 100M] : Current to Voltage Conversion Gain Switching

Displayed only when the I input is selected.

The current to voltage conversion factor can be selected from {1 M | 100 M}.

[1MΩ | 100M] : Input Impedance Switching

Displayed only when the HF *1 input is selected.

The input resistance can be selected from {1 MΩ | 50 Ω}.

[COUPLING] : Input Coupling Selection

Displayed only when the A, A-B, or I input is selected.

The input coupling can be selected from {AC | DC}. However, only the current to voltage conversion coupling is available for the I input.

Input connector	A / A-B	C *1	I		HF *1
Conversion factor	-----	-----	1 M (10 ⁶)	100 M (10 ⁸)	-----
Input resistance	10 MΩ	1 MΩ	-----	-----	1 MΩ 50 Ω
COUPLING	AC DC	AC	AC	DC	AC
Sensitivity range	10 nV to 1 V	1 mV to 10 V	100 fA to 1 μA	10 fA to 10 nA	1 mV to 1 V
Frequency range	0.5 Hz to 3 MHz				10 kHz to 11 MHz

For details, see "4.5 Input Connector Setting and Connection"

[GROUND] : Select Signal Ground

The signal ground processing can be selected from {FLOAT | GND}.

- **FLOAT** : Float from the enclosure (impedance to the enclosure 10 k Ω)
- **GND** : Grounded to the enclosure (impedance to the enclosure 10 Ω)

[LINE NOTCH>] : {Line Filter Setting Screen}

Pressing this soft key switches to {Line Filter Setting Screen}.

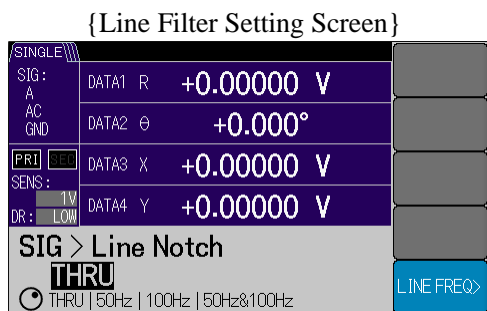

The line filter function (removal frequency) can be selected.

- When line frequency is 50 Hz: {THRU | 50 Hz | 100 Hz | 50 Hz&100 Hz}
- When line frequency is 60 Hz: {THRU | 60 Hz | 120 Hz | 60 Hz&120 Hz}

[LINE FREQ>] : {Line Frequency Selection Screen}

Pressing this soft key switches to {Line Frequency Selection Screen}.

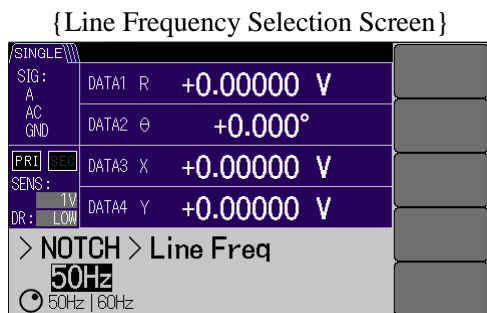

The line frequency (fundamental) can be selected from {50 Hz | 60 Hz}.

3.6.6 PHASE : {Phase Adjustment Screen}

When you enter this setting screen, you can move through the digits using the left/right cursor keys and then adjust the phase shift amount for the reference signal using the MODIFY knob and up/down keys.

The setting range is $\{-180.000^\circ$ to $+179.999^\circ\}$.

If the phase shift amount exceeds $+179.999^\circ$, it wraps to -180.000° , and if it falls below -180.000° , it wraps to $+179.999^\circ$.

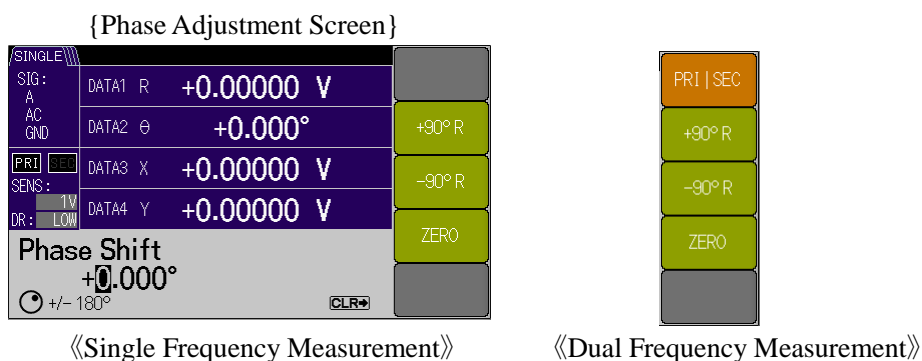

[PRI | SEC] : Detector Switching

For single frequency measurement, this soft key is not displayed.

For dual frequency measurement, the phase shift amount can be set individually for the primary and secondary PSD's.

[+90°R] : Shift Amount 90° Increase

Press this soft key to increase the phase shift amount for the reference signal by 90° .

[-90°R] : Shift Amount 90° Decrease

Press this soft key to decrease the phase shift amount for the reference signal by 90° .

[ZERO] : Set Shift Amount to 0°

Press this soft key to set the phase shift amount for the reference signal to 0° .

3.6.7 [REF]: {Reference Signal Setting Screen}

When you enter this setting screen, you can select SOURCE using the MODIFY knob and up/down keys.

*1: Only the LI5660 is equipped with input connectors C and HF.

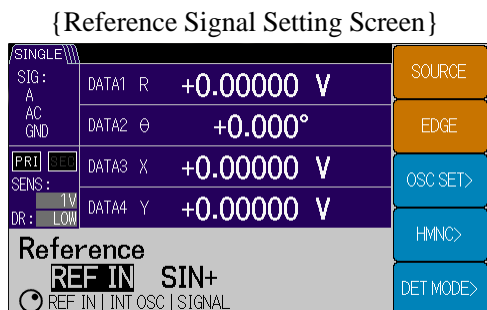

[SOURCE] : Select Reference Signal Source

The reference signal can be selected from {REF IN | INT OSC | SIGNAL}.

- REF IN : External reference signal (REF IN connector)
- INT OSC : Internal oscillator
- SIGNAL : Measurement signal (for input connector A, etc.)

[EDGE] : Select Reference Signal Waveform

Displayed only when REF IN is selected.

The waveform of the external reference signal can be selected from {SIN+ | TTL+ | TTL-}.

- SIN+ : Rise zero cross point of the sine wave, etc.
(Not displayed when the input connector is HF.)
- TTL+ : Rise edge of the TTL level square wave
- TTL- : Fall edge of the TTL level square wave

[OSC SET>] : {Oscillator Setting Screen}

Pressing this soft key switches to {Oscillator Setting Screen} to set the internal oscillator and sine wave output (OSC OUT).

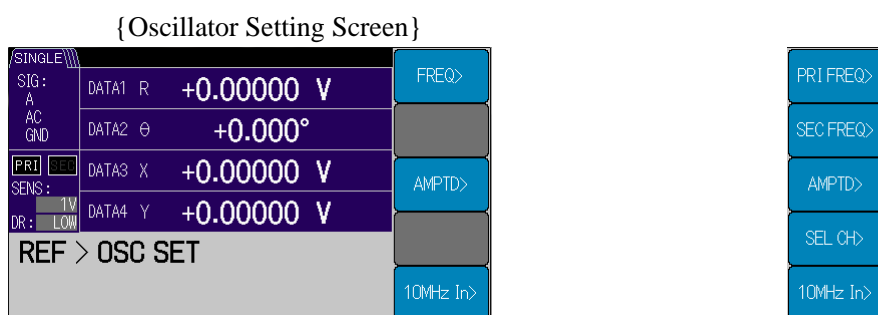

《Detection Mode SINGLE / DUAL1》

《Detection Mode DUAL2 / CASCADE》

[FREQ>] : {Frequency Setting Screen}

Pressing this soft key switches to {Frequency Setting Screen } for the internal oscillation frequency (primary PSD).

When you enter this setting screen, you can move through the digits using the left/right cursor keys and then set the frequency using the MODIFY knob and up/down keys.

This soft key is displayed when INT OSC or SIGNAL is selected as the reference signal.

Also, When the detection mode is DUAL2 and the reference signal is INT OSC or SIGNAL, when the detection mode is CASCADE, this soft key is displayed as [PRI FREQ>].

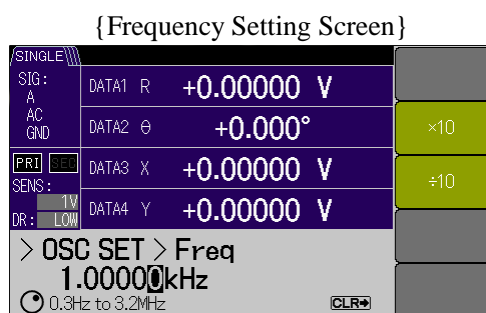

The frequency for the internal oscillator can be set. The setting range varies depending on the input signal connector.

- A, A-B, C^{*1}, I connectors : 0.3 Hz to 3.2 MHz
(6-digit resolution, 0.1 mHz for 100 Hz or less)
- HF^{*1} connector : 8 kHz to 11.5 MHz (6-digit resolution)

FREQ_p is displayed in the normal measurement screen and F_p is displayed in the fine measurement screen.

[×10] : Move Decimal Point to Right for Frequency

You can move the decimal point in the frequency setting to the right.

[÷10] : Move Decimal Point to Left for Frequency

You can move the decimal point in the frequency setting to the left.

[SEC FREQ>] : {Secondary Frequency Setting Screen}

The setting screen for the internal oscillation frequency (secondary PSD) is displayed. When the detection mode is DUAL2, this soft key is displayed when the detection mode is CASCADE and the reference signal is INT OSC.

The frequency for the internal oscillator can be set. The setting range varies depending on the input signal connector.

- A, A-B, C^{*1}, I connectors : 0.3 Hz to 3.2 MHz
(6-digit resolution, 0.1 mHz for 100 Hz or less)
- HF^{*1} connector : 8 kHz to 11.5 MHz (6-digit resolution)

FREQ_s is displayed in the normal measurement screen and F_s is displayed in the fine measurement screen.

[×10] : Move Decimal Point to Right for Frequency

You can move the decimal point in the frequency setting to the right.

[÷10] : Move Decimal Point to Left for Frequency

You can move the decimal point in the frequency setting to the left.

[AMPTD>] : {Amplitude Setting Screen}

{Amplitude Setting Screen} for the sine wave output (OSC OUT) is displayed.

When you enter this setting screen, you can move through the digits using the left/right cursor keys and then set the amplitude value using the MODIFY knob and up/down keys.

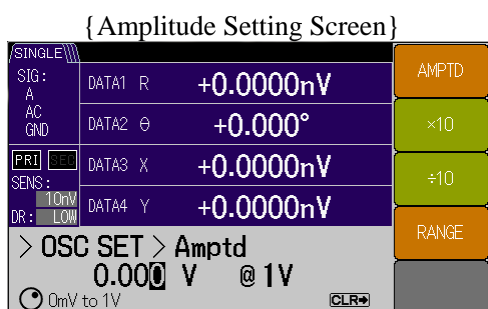
**[AMPTD] : Amplitude Setting**

The amplitude value can be set.

[×10] : Move Decimal Point to Right for Amplitude Value

You can move the decimal point for the amplitude setting value to the right.

[÷10] : Move Decimal Point to Left for Amplitude Value

You can move the decimal point for the amplitude setting value to the left.

[RANGE] : Amplitude Range Setting

The amplitude range for the sine wave output can be set.

Range	10 mV	100 mV	1 V
Amplitude range	0 to 10.00 mVrms	0 to 10.00 mVrms	0 to 1.000 Vrms
Resolution	0.01 mVrms	0.1 mVrms	0.001 Vrms

In the case of input connector HF*¹, the output is 0 Vrms regardless of the setting.

If the frequency exceeds 3.2 MHz, the output is 0 Vrms regardless of the setting.

■ **Setting the Amplitude Value to 0 Vrms**

If the amplitude value is set to 0 Vrms using the MODIFY knob and up/down keys, the clock for the sine wave source D/A converter is stopped.

Noise in the device is reduced so very small signal measurement is more immune to disturbance.

[SEL CH>] : {OSC Output Oscillator Selection Screen}

Displayed when DUAL2 / CASCADE is selected for the detection mode.

The internal oscillator {PRI | SEC} to output the sine wave can be selected.

- PRI : Outputs the FREQ_p frequency of the oscillator in the primary PSD.
- SEC : Outputs the FREQ_s frequency of the oscillator in the secondary PSD.

[10MHz IN>] : {External 10 MHz Setting Screen}

{ON | OFF} for 10MHz IN on the rear panel can be selected.

A signal generator and other devices and the LI5655 / LI5660 can be synchronized with the common 10 MHz frequency source. For details, see "5.4 External 10 MHz Synchronization"

[HMNC>] : {Harmonic Setting Screen}

Displayed when SINGLE / DUAL1 is selected for the detection mode.

Pressing this soft key switches to {Harmonic Setting Screen}.

When you enter this setting screen, you can set ON or OFF for the setting (primary PSD) using the MODIFY knob and up/down keys.

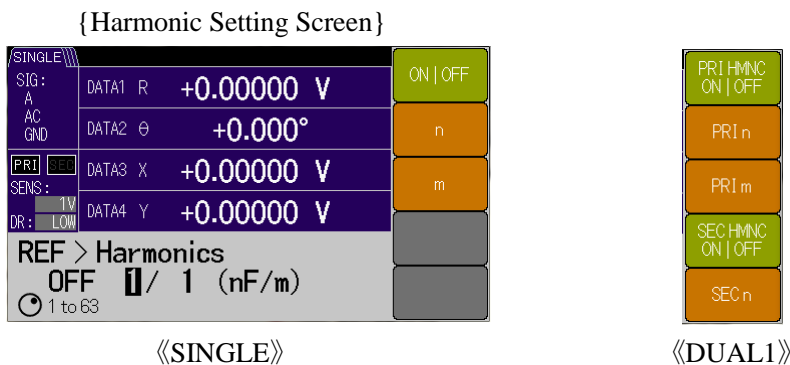

[ON | OFF] : Harmonic ON / OFF

{ON | OFF} can be selected for the harmonic setting (primary PSD).

If DUAL1 is selected for the detection mode, [PRI HMNC ON | OFF] is displayed.

[n] : n-order Harmonic Setting

An n-fold harmonic {n: 1 to 63} for the reference signal can be set.

If DUAL1 is selected for the detection mode, [PRI n] is displayed.

[m] : 1/m Fractional Harmonic

A 1/m-fold subharmonic {m: 1 to 63} for the reference signal can be set.

Fractional harmonic (n/m-fold) can be set by combining the harmonic and subharmonic.

If DUAL1 is selected for the detection mode, [PRI m] is displayed.

[SEC HMNC] : Secondary PSD Harmonic ON / OFF

Displayed when DUAL1 is selected for the detection mode.

{ON | OFF} can be selected for the harmonic setting (secondary PSD).

[SEC n] : n-order Harmonic Setting (Secondary PSD)

Displayed when DUAL1 is selected for the detection mode.

An n-fold harmonic {n: 1 to 63} for the reference signal (secondary PSD) can be set.

[DET MODE >] : {Detection Mode Setting Screen}

Pressing this soft key switches to {Detection Mode Setting Screen}.

When you enter this setting screen, you can select the detection mode using the MODIFY knob and up/down keys.

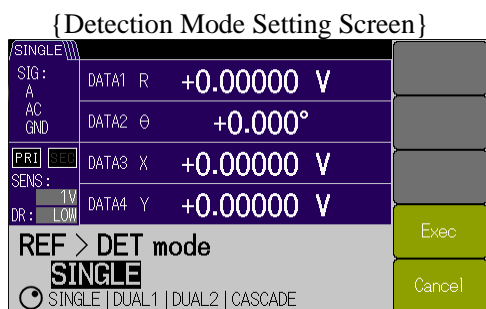

The LI5655 / LI5660 are equipped with two dual-phase PSDs.

The detection mode can be selected from {SINGLE | DUAL1 | DUAL2 | CASCADE}.

Detection mode	Function description
SINGLE Normal mode	Measures the signal components of a normal single frequency, fundamental wave (1F), and fractional harmonic (nF/m).
DUAL1 Fractional harmonic mode	Simultaneously measures the signal components of a fractional harmonic (nF/m) using the primary PSD and those of a harmonic (nF) using the secondary PSD.
DUAL2 Independent frequency mode	Simultaneously measures the signal components of a primary frequency using the primary PSD and those of a secondary frequency using the secondary PSD.
CASCADE Cascade mode	Detects a primary frequency signal using the primary PSD and detects that result with a secondary frequency using the secondary PSD.

[Exec] : Execute Detection Mode Setting

Executes the selected detection mode.

[Cancel] : Cancel Detection Mode Setting

Returns to the reference signal setting screen without executing the selected detection mode.

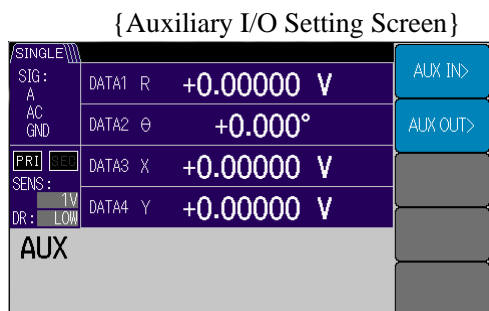
3.6.8 **AUX** : {Auxiliary I/O Setting Screen}

[AUX IN>]: {Auxiliary Input Setting Screen}

Pressing this soft key switches to {Auxiliary Input Setting Screen}.

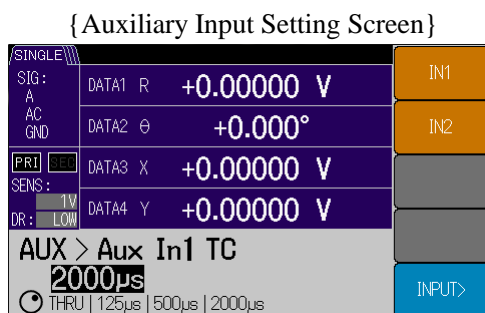

[IN1]: Select AUX IN1 Smoothing Time Constant

The smoothing time constant for auxiliary input AUX IN1 can be selected from {THRU | 125 μs | 500 μs | 2000 μs}.

[IN2]: Select AUX IN2 Smoothing Time Constant

The smoothing time constant for auxiliary input AUX IN2 can be selected from {THRU | 12 5μs | 500 μs | 2000 μs}.

[INPUT>]: {AUX IN ON / OFF Screen}

Pressing this soft key switches to {AUX IN ON / OFF Screen}.

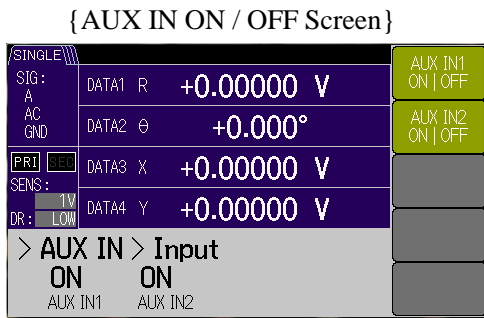

[AUX IN1 ON | OFF] : AUX IN1 ON / OFF

{ON | OFF} can be selected for the auxiliary input AUX IN1 measurement function.

[AUX IN2 ON | OFF] : AUX IN2 ON / OFF

{ON | OFF} can be selected for the auxiliary input AUX IN2 measurement function.

■ Stopping the AUX IN Input Function

When the AUX IN measurement function is set to OFF, the clock for the internal A/D converter stops. Noise in the device is reduced so very small signal measurement is more immune to disturbance.

[AUX OUT>]: {Auxiliary Output Setting Screen}

Pressing this soft key switches to {Auxiliary Output Setting Screen}.

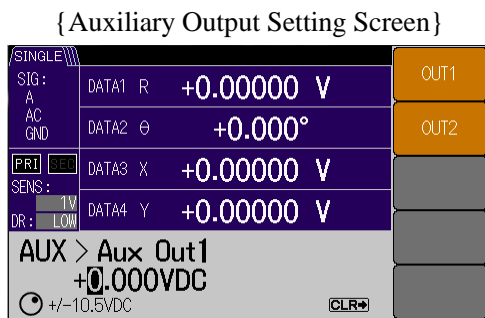

[OUT1]: AUX OUT1 Voltage Setting

The set DC voltage {-10.500 V to +10.500 V, 0.001 V resolution} can be output to the auxiliary output AUX OUT1.

[OUT2]: AUX OUT2 Voltage Setting

The set DC voltage {-10.500 V to +10.500 V, 0.001 V resolution} can be output to the auxiliary output AUX OUT2.

3.6.9 **UTIL** : {Utility Screen}

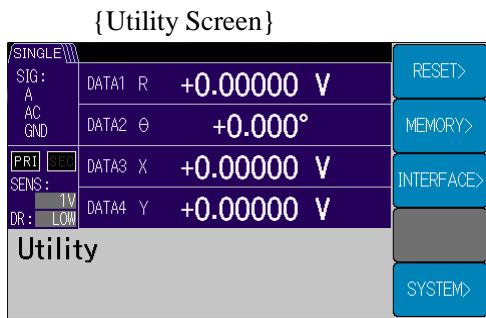

[RESET>] : {Reset Screen}

Pressing this soft key switches to {Reset Screen}.



[Exec] : Execute Reset

Executes a reset.

[Cancel] : Cancel Reset

Returns to the utility screen without executing a reset.

[MEMORY>] : {Setting Memory Screen}

Pressing this soft key switches to {Setting Memory Screen}.

When you enter this setting screen, you can select the memory number using the MODIFY knob and up/down keys.

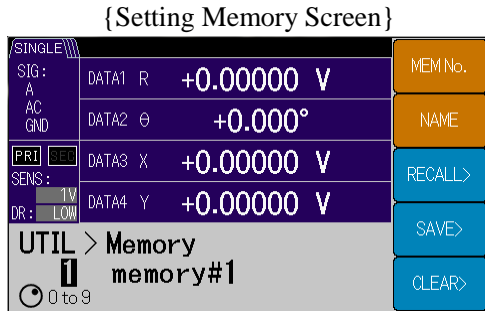
**[MEM No.] : {Select Setting Memory}**

The setting memory number for saving the setting to the device memory, recalling it, and clearing it can be specified.

[NAME] : Change Setting Memory Name

The setting memory name can be edited.

Up to 8 characters can be selected from {Blank, A to Z, a to z, 0 to 9, #, @, - } and specified for the string.

[RECALL>] : {Setting Memory Recall Screen}

Pressing this soft key switches to the setting memory recall confirmation screen.

[Exec] : Execute Setting Memory Recall

Executes the setting recall from the selected setting memory.

[Cancel] : Cancel Recall

Returns to the setting memory screen without executing setting recall.

[SAVE>] : {Setting Memory Save Screen}

Pressing this soft key switches to the setting memory save confirmation screen.

[Exec] : Execute Setting Memory Save

Executes the setting save for the selected setting memory.

[Cancel] : Cancel Save

Returns to the setting memory screen without executing the saving of settings.

[CLEAR>] : {Setting Memory Clear Screen}

Pressing this soft key switches to the setting memory clear screen.

[Exec] : Execute Setting Memory Clear Individually

Executes the selected setting memory clear (delete).

[Cancel] : Cancel Setting Memory Clear

Returns to the setting memory screen without executing clear.

[INTERFACE>] : {Interface Setting Screen}

Pressing this soft key switches to {Interface Setting Screen}.

For details, see " LI5655 / LI5660 Instruction Manual (Remote Control)"

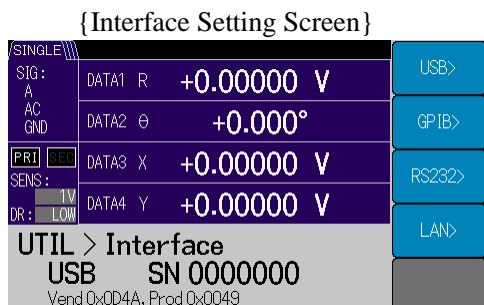

[USB>] : {USB Information Screen}

Pressing this soft key switches to {USB Information Screen}.

There is no setting for USB, but the vendor ID, product ID, and serial number are displayed in the setting screen.

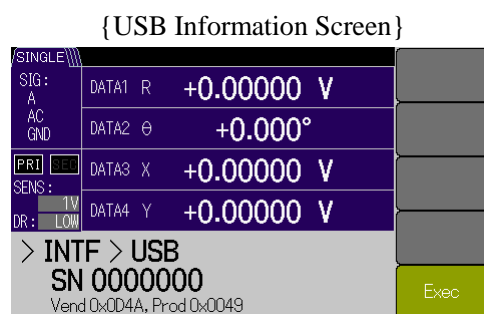

[Exec] : Execute USB Communication Selection

Selects USB for the interface.

[GPIB>] : {GPIB Setting Screen}

Pressing this soft key switches to {GPIB Setting Screen}.

When you enter this setting screen, you can move through the digits using the left/right cursor keys and then set the GPIB address {0 to 30} using the MODIFY knob and up/down keys.

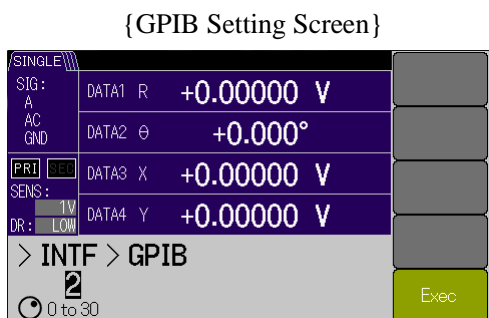

[Exec] : Execute GPIB Communication Selection

Confirms the GPIB address and selects GPIB for the interface.

[RS232>] : {RS232 Setting Screen}

Pressing this soft key switches to {RS232 Setting Screen}.

When you enter this setting screen, you can set the baud rate using the MODIFY knob and up/down keys.

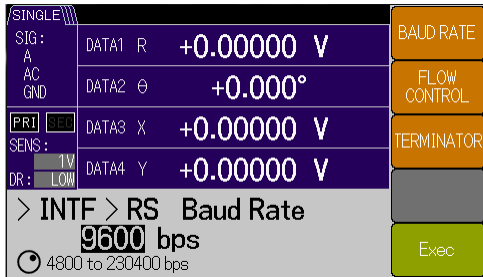
{RS232 Setting Screen}**[BAUD RATE] : Baud Rate Setting**

Baud rate {4800 | 9600 | 19200 | 38400 | 57600 | 115200 | 230400[bps]} can be set.

[FLOW CONTROL] : Flow Control Setting

Flow control {NONE | SOFT | HARD} can be set.

- NONE : No handshake
- SOFT : Software handshake (X-ON/X-OFF)
- HARD : Hardware handshake (RTS, CTS)

[TERMINATOR] : Terminator Setting

Terminator {LF | CRLF} can be set.

- LF : Terminator is one character of LF (Line Feed).
- CRLF : Terminator is two characters of CR (Carriage Return) and LF.

[Exec]: Execute RS232 Communication Selection

Confirms various settings and selects RS232 for the interface.

[LAN>] : {LAN Setting Screen}

Pressing this soft key switches to {LAN Setting Screen}.

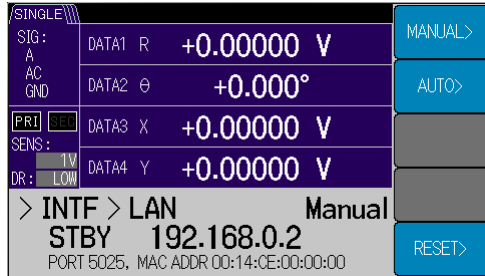
{LAN Setting Screen}**[MANUAL>] : {Address Manual Setting Screen}**

Pressing this soft key switches to {Address Manual Setting Screen}.

When you enter this setting screen, you can move through the digits using the left/right cursor keys and then set the IP address using the MODIFY knob and up/down keys.

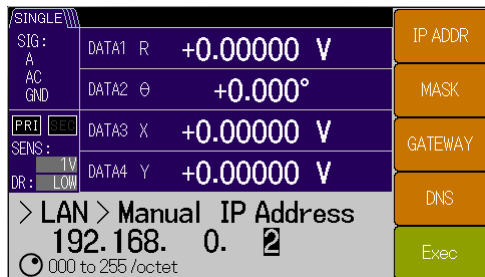
{Address Manual Setting Screen}**[IP ADDR] : IP Address Setting**

The IP address can be set.

[MASK] : Subnet Mask Setting

The subnet mask can be set.

[GATEWAY] : Default Gateway Setting

The default gateway can be set.

[DNS] : DNS Setting

The DNS can be set.

[Exec] : Execute LAN Communication Selection

Confirms various settings and selects LAN for the interface.

In this case, the device operates with the static addresses set above.

[AUTO>] : {Address Auto Setting Screen}

Pressing this soft key switches to {Address Auto Setting Screen}.

(Firmware version 1.50 or later)

{ Address Auto Setting Screen }

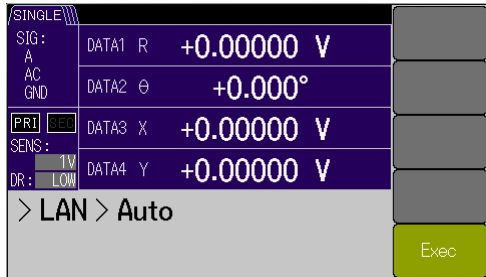

[Exec] : Execute LAN Communication Selection

Confirms various settings and selects LAN for the interface.

In this case, the device operates with the dynamic addresses that are assigned by using DHCP and APIPA (Automatic Private IP Addressing).

[RESET>] : {LAN Reset Screen}

Pressing this soft key switches to {LAN Reset Screen}.

(Firmware version 1.50 or later)

{LAN Reset Screen}



[Exec] : Reset LAN Settings

Reset LAN settings and select LAN communication with auto setting.

[Cancel] : Cancel Resetting

Return to {LAN Setting Screen}.

[SYSTEM>] : {System Setting Screen}

Pressing this soft key switches to {System Setting Screen}.

This is a screen for the maintenance and management of the LI5655 / LI5660.

{System Setting Screen}

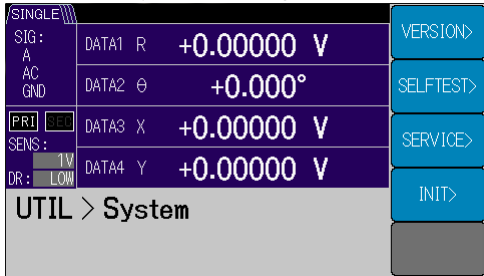

[VERSION>] : {Version Information Screen}

Pressing this soft key displays {Version Information Screen} of the device.

{Version Information Screen}

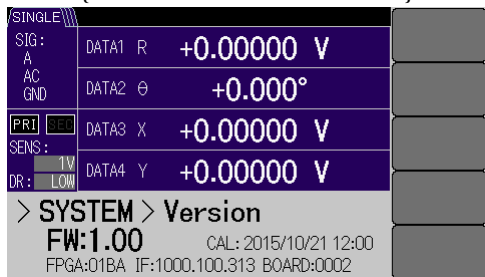

Displays the firmware version and last adjustment date and time.

[SELF TEST>] : {Self-Diagnosis Screen}

Pressing this soft key switches to {Self-Diagnosis Screen}.

An external connection, etc. is required for the self-diagnosis. For details, refer to "8.5.1 Self Test"

{Self-Diagnosis Screen}

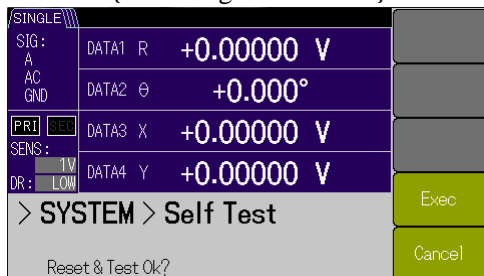

[Exec] : Execute Self-Diagnosis

Executes the self-diagnosis.

[Cancel] : Cancel Self-Diagnosis

Stops the self-diagnosis and returns to the system setting screen.

Operation Message

The process ("Executing...") is displayed during the execution.

When the execution is completed successfully, "Done" is displayed for a short time.

If there is a problem, an error message and "Error" are displayed. In this case, the screen does not return to the original measurement screen but remains unchanged.

If the execution is stopped or interrupted, "Canceled" is displayed and the screen returns to the original measurements screen.

[SERVICE >] : {Maintenance Information Screen}

Pressing this soft key displays {Maintenance Information Screen} of the device.

The operating time (in minutes) and power on count are displayed.

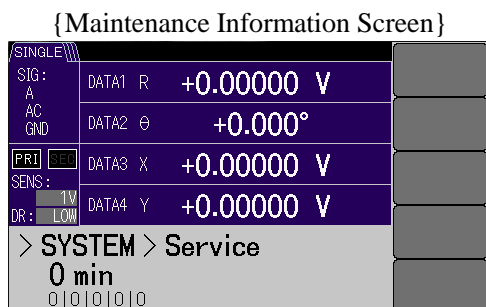

[INIT >] : {Initialize Execution Screen}

Pressing this soft key displays {Initialize Execution Screen}.

Initialize restores the factory default state.

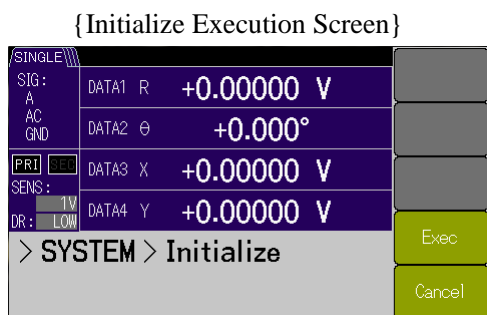

[Exec] : Execute Initialize

Executes the initialize operation.

[Cancel] : Cancel Initialize

Returns to the utility screen without executing the initialize operation.

3.7 Initial Settings

The settings of the LI5655 / LI5660 are the initial settings in the following cases.

- At the Time of Shipment from the Factory

All the settings are the initial settings. The setting memory is empty.

When [SYSTEM>]-[INIT>] is executed from **UTIL**: {Utility Screen}, the settings are reset to the factory default settings.

However, the maintenance information is not changed.

- When Executing the Reset Command

Resets settings other than the setting memory, power supply frequency, interface, and key lock settings to the initial settings.

Panel Operation

In **UTIL**: {Utility Screen}, press the soft key in order of [RESET] and [Exec].

Remote Control Command

* RST command

- When Executing the System Reset Command

Resets all settings except for the interface setting to the initial settings.

Remote Control Command

:SYSTem:RST,

- If there is an error with the resume memory where the last settings are stored when the power is turned on

The part with the error is reset to the initial state.

(If all is normal, the last settings are restored)

For details on the initial setting items and content, see "Table 3-1 Setting Items and Initial Values"

Table 3-1 shows also the relationship of the auto setting function, setting memory, and resume with each parameter.

*1: Only the LI5660 is equipped with the C and HF inputs.

3.7 Initial Settings

Table 3-1 Setting Items and Initial Values 1/4

Setting item	Parameter range	Initial value	:SYST:RST	*RST	AUTO MEAS	Setting memory	Resume
<Measurement Screen>	NORMal LARGe FINE	NORM	←	←	N	Y	Y
<Measured Data>							
DATA1		R (SINGLE)	←	←	←	Y	Y
SINGLE	X R AUX 1 NOIS	R	←	←	↑	Y	Y
DUAL1 DUAL2 CASCADE	Xp Rp Yp θp Xs Rs AUX 1 NOIS	Rp	←	←	↑	Y	Y
DATA2		θ (SINGLE)	←	←	←	Y	Y
SINGLE	Y θ AUX1 AUX2	θ	←	←	↑	Y	Y
DUAL1 DUAL2 CASCADE	Yp θp Xs Rs Ys θs AUX1 AUX2	θp	←	←	↑	Y	Y
DATA3		X (SINGLE)	←	←	←	Y	Y
SINGLE	X R	X	←	←	↑	Y	Y
DUAL1 DUAL2 CASCADE	Xp Rp Yp θp Xs Rs	Xp	←	←	↑	Y	Y
DATA4		Y (SINGLE)	←	←	←	Y	Y
SINGLE	Y θ	Y	←	←	↑	Y	Y
DUAL1 DUAL2 CASCADE	Yp θp Xs Rs Ys θs	Yp	←	←	↑	Y	Y
DATA OUTPUT							
DATA1 DATA2 DATA3 DATA4	ON OFF ON OFF ON OFF ON OFF	ON ON ON ON	←	←	←	Y	Y
<Noise Smoothing Factor>	1 4 16 64	1	←	←	N	Y	Y
<Offset>	(Primary / Secondary PSD, Standalone)						
X Offset ON / OFF Range	OFF ON ±105.000 %	OFF 0 %	←	←	←	Y	Y
Y Offset ON / OFF Range	OFF ON ±105.000 %	OFF 0 %	←	←	←	Y	Y
<Arithmetic Function>	OFF EXPAND NORM RATIO	OFF	←	←	N	Y	Y
<EXPAND Scale Factor>	(Primary / Secondary PSD, Standalone)						
X / R EXPAND Scale Factor	1 10 100	1	←	←	←	Y	Y
Y EXPAND Scale Factor	1 10 100	1	←	←	←	Y	Y
<Normalize>							
Display Form	% dB %FS	%	←	←	←	Y	Y
Standard Value V I	1 nV to 10 V 1 fA to 1 μA	1 V 1 μA	←	←	←	Y	Y
User Unit	Up to 3 characters (specified character types)	Blank	←	←	←	Y	Y

3.7 Initial Settings

Table 3-1 Setting Items and Initial Values 2/4

Setting item	Parameter range	Initial value	:SYST:RST	*RST	AUTO MEAS	Setting memory	Resume
<Ratio Arithmetic Expression>							
SINGLE DUAL1 DUAL2 CASCADE	RATIO1 RATIO1 RATIO2 RATIO1 RATIO2 RATIO1	RATIO1	←	←	←	Y	Y
Ratio Scale Factor K	0.10000 to 10.0000	1	←	←	←	Y	Y
<Sensitivity>	(Primary / Secondary PSD, Standalone)						
Sensitivity *1	A, A-B 10 nV to 1 V C 1 mV to 10 V I (1M) 100 fA to 1 μA I (100M) 10 fA to 10 nA HF 1 mV to 1 V (1-2-5)	1 V (1 V) (1 μA) (10 nA) (1 V)	←	←	A	Y	Y
Always Auto Selection	OFF ON	OFF	←	←	←	Y	Y
<Dynamic Reserve>	HIGH MED LOW	LOW	←	←	A	Y	Y
<Time Constant Filter>	(Primary / Secondary PSD, Standalone)						
Time Constant	1 μs to 50 ks (1-2-5)	100 ms	←	←	A	Y	Y
Attenuation Slope	6 12 18 24 dB/oct	24 dB/oct	←	←	←	Y	Y
Filter Type	TC SYNC	TC	←	←	A	Y	Y
<PSD Input Offset>	(Primary / Secondary PSD, Common)						
PSD Continuous Auto Adjustment Settling Time Adjustment Value	HOLD AUTO 200 ms 750 ms 3000 ms Not disclosed	AUTO 200 ms Factory default value	← ← ←	← ← ←	← N N	Y Y Y	Y Y Y
<Signal Input>							
Input Connector *1	A A-B C I HF	A	←	←	N	Y	Y
Current to Voltage Conversion Gain	1 M 100 M	1 M	←	←	A	Y	Y
Input Coupling	AC DC	AC	←	←	A	Y	Y
Signal Ground	FLOAT GROUND	GROUND	←	←	N	Y	Y
HF Input Impedance *1	1 MΩ 50 Ω	1 MΩ	←	←	N	Y	Y
<Signal Filter>							
Line Filter	THRU L1 L2 L1&L2 L1 is 50 Hz or 60 Hz L2 is 100 Hz or 120 Hz	THRU (OFF)	←	←	←	Y	Y
Line Frequency	50 60 Hz	50 Hz (factory default)	N	N	N	N	W
<Phase Adjustment>	(Primary / Secondary PSD, Standalone)						
Phase Shift Amount	-180.000 to +179.999°	0 °	←	←	←	Y	Y
<Detection Mode>	SINGLE DUAL1 DUAL2 CASCADE	SINGLE	←	←	N	Y	Y
<Reference Signal>							
Reference Signal Source	REF IN INT OSC SIGNAL	REF IN	←	←	N	Y	Y
Waveform (REFERENCE INPUT)	SIN+ TTL+ TTL-	SIN+	←	←	N	Y	Y

3.7 Initial Settings

Table 3-1 Setting Items and Initial Values 3/4

Setting item	Parameter range	Initial value	:SYST:RST	*RST	AUTO MEAS	Setting memory	Resume
<Internal Oscillator>							
Frequency *1 A, A-B, C, and I inputs for both the primary and secondary frequencies HF input for both the primary and secondary frequencies	Detection mode {SINGLE, DUAL1, DUAL2}						
	0.3000 Hz to 3.20000 MHz	1.00000 kHz	↑	←	N	Y	Y
Frequency *1 A, A-B, C, and I inputs for both the primary and secondary frequencies HF input Primary frequency Secondary frequency	8 kHz to 11.5000 MHz	10.0000 kHz	↑	←	N	Y	Y
	Detection mode CASCADE						
	0.3000 Hz to 3.20000 MHz	1.00000 kHz	↑	←	N	Y	Y
	8.00000 kHz to 11.5000 MHz	10.0000 kHz	↑	←	N	Y	Y
	0.3000 Hz to 3.20000 MHz	1.00000 kHz	↑	←	N	Y	Y
Output Voltage Range	10 m 100 m 1 Vrms	1 Vrms	←	←	N	Y	Y
Output Voltage (Amplitude)	0.00 m to 1.000 Vrms	0.000 Vrms	←	←	N	Y	Y
Output Selection	PRI SEC	PRI	←	←	N	Y	Y
10MHz In	OFF ON	OFF	←	←	N	Y	Y
<Harmonic>							
Primary PSD	OFF ON	OFF	←	←	N	Y	Y
Secondary PSD	OFF ON	OFF					
Primary PSD-n	1 to 63	1					
Primary PSD-m	1 to 63	1	←	←	N	Y	Y
Secondary PSD-n	1 to 63	1					
<Auxiliary Input>							
AUX IN 1 Time Constant	THRU 125 μs 500 μs 2000 μs	2000 μs	←	←	N	Y	Y
AUX IN 2 Time Constant	THRU 125 μs 500 μs 2000 μs	2000 μs	←	←	N	Y	Y
AUX INPUT							
AUX IN 1	ON OFF	ON	←	←	←	Y	Y
AUX IN 2	ON OFF	ON	←	←	←	Y	Y
<Auxiliary Output>							
AUX OUT 1 Range	±10.5000 V	0 V	←	←	N	Y	Y
AUX OUT 2 Range	±10.5000 V	0 V	←	←	N	Y	Y
<Key Lock>							
	OFF ON	OFF (Cancellation)	←	N	N	N	N
<Lamp Control>							
	OFF ON	ON (Lit)	←	N	N	N	N
<Data Transfer Format>							
	ASCII real number integer	ASCII	←	←	N	N	N
Measured Data Set (for query)	STATUS, DATA1, DATA2, DATA3, DATA4, FREQ	DATA1 + DATA2	←	←	N	N	N
<Measured Data Buffer>							
Measured Data Set (for recording)	STATUS, DATA1, DATA2, DATA3, DATA4, FREQ	DATA1 + DATA2	←	←	N	N	N
FEED:CONTRol BUF1, BUF2, BUF3	Send Not send	Not send	←	←	←	N	N
Buffer Size BUF1, BUF2, BUF3	(Unit: Sample point) 16 to 8192 16 to 65536	(Maximum value) 8192 65536	←	←	N	N	N

3.7 Initial Settings

Table 3-1 Setting Items and Initial Values 4/4

Setting item	Parameter range	Initial value	:SYST:RST	*RST	AUTO MEAS	Setting memory	Resume
<Trigger>							
Trigger Source	MAN EXT BUS	BUS	←	←	N	Y	Y
Trigger Delay Time	0 to 100 s 640 ns ×N	0 s	←	←	N	Y	Y
Timer Function	ON OFF	OFF	←	←	N	Y	Y
Timer Period	1.92E-6 to 20 s 640 ns ×N	10 ms	←	←	N	Y	Y
<Interface>							
Type	USB GPIB RS232 LAN	USB	N	N	N	N	W
GPIB Address	0 to 30	2	N	N	N	N	W
RS-232 Baud Rate	4800 to 230400	9600	N	N	N	N	W
RS-232 Flow Control	LF CR LF	CR LF	N	N	N	N	W
RS-232 Terminate	NONE SOFT HARD	NONE	N	N	N	N	W
LAN IP Address	0.0.0.0 to 255.255.255.255	192.168.0.2	N	N	N	N	W
LAN Subnet Mask	0.0.0.0 to 255.255.255.255	255.255.255.0	N	N	N	N	W
LAN Default Gateway	0.0.0.0 to 255.255.255.255	0.0.0.0	N	N	N	N	W
LAN DNS	0.0.0.0 to 255.255.255.255	0.0.0.0	N	N	N	N	W
<Setting Memory>							
Content	—	Initial value	←	N	N	—	W

■ Remark

Initial value At the time of shipment from the factory

:SYST:RST Remote control when executing the :SYSTEM:RST command

*RST Remote control when executing the *RST command

The **UTIL** [RESET] operation is the same as the *RST command, except that the :INIT:CONT system is not influenced.

← Same as on left (initial value)

↑ Refer to above

A Depending on the auto setting function (the result varies depending on the situation)

N There is no function (no influence)

Y There is the function

W There is the function However, data is held independently from the general resume objects.

Set by remote control / cannot be queried.

— Not applicable

The following is not covered by the scope of resume.

- Measurement data stored in the measurement data buffer
- Latest measurement data
- Sensitivity and dynamic reserve selected in Continuous Auto Setting

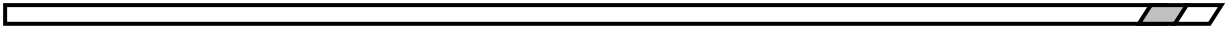

(Blank)

4. Basic Operations

4.1 Display and Operation when Power Is Turned On	4-3
4.1.1 Check before Turning On the Power	4-3
4.1.2 Startup Screen and Operation on Startup.....	4-3
4.2 Simple Operation Procedure for Using the Device for the First Time	4-4
4.3 Measurement Parameter Setting, Output, and Display	4-8
4.4 Reference Signal Setting and Connection.....	4-11
4.5 Input Connector Setting and Connection.....	4-15
4.6 Time Constant Filter Setting and Characteristics	4-23
4.6.1 How to Set the Filter.....	4-23
4.6.2 Time Constant Filter Characteristics.....	4-24
4.6.3 Auto Setting of Time Constant.....	4-27
4.7 Sensitivity and Dynamic Reserve Setting	4-28
4.7.1 How to Set the Sensitivity.....	4-28
4.7.2 Sensitivity and Dynamic Reserve Auto Setting.....	4-30
4.7.3 Signal Over-level Display and Monitor Output.....	4-31
4.8 Phase Adjustment	4-33

This chapter describes the basic operations for the normal single frequency and dual-phase detection.

For details on advanced usage, see "5. Advanced Operations"

For details on dual frequency measurement, see "6. Dual Frequency Measurement"

4.1 Display and Operation when Power Is Turned On

4.1.1 Check before Turning On the Power

Before setting the power switch to ON, see "2.3 Grounding and Connecting to Power Outlet" and check that the device is grounded and the setting of the power voltage selector switch is appropriate.

4.1.2 Startup Screen and Operation on Startup

When the power switch is set to ON, the startup screen is displayed. Furthermore, all lamps are lit for the first several seconds to check operation. ☞ "3.7 Initial Settings"



Startup Screen

During this period, the internal initial settings are configured and self-diagnosis is performed. If an error is detected, an error message is displayed.

If a critical error is detected, an error message is displayed and operation becomes no longer possible.



Error Message at Startup
(for Reference)

If the last settings are lost, an error message is displayed, but the error parameter is reset and the startup screen is displayed. This error message can be cleared by pressing any key.

For details, ☞ 7.1.1 Power-On Errors.

For details on the reset information,

☞ "3.7 Initial Settings"

If there is no error with the resume memory where the last settings are stored, the settings when the power was turned off last are restored.

When the device starts up normally, a message is displayed for several seconds and then the measurement screen is displayed.

For details, ☞ "3.4 Overview of the Operation Screen".

After this point, measurement and panel operations are possible.

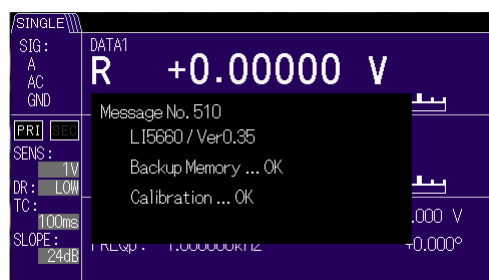

Message at Normal Startup

It takes about 30 seconds from startup before the remote control function can be used. During this period, the REMOTE lamp flashes, but setting and measurement operations can be performed using the operation keys.

4.2 Simple Operation Procedure for Using the Device for the First Time

If a proper reference signal is obtained for the sine wave or square wave (duty about 50%), a measurement can be performed using the following simple procedure.

- Reset ([UTIL] → [RESET>] → [Exec])
 - Connect the measured signal (→ A) and reference signal (→ REF IN)
 - Auto setting ([AUTO] → [MEASURE])
- At the measurement screen
- Manual adjustment (Sensitivity: Time constant:)
 - Select the measurement data (/ DATA key: Select from R-θ or X-Y)

1) Reset

- Press the [UTIL] key to display the {Utility Screen}.
- Press the [RESET>] soft key and then the [Exec] soft key in the lower-level screen.

The reset operation can be canceled using the [Cancel] soft key.

You can return to the upper-level operation screen or measurement screen using the [SCRN] / EXIT key.

The above reset operation results in the following settings.

Signal input connector	A (single-ended)
Input coupling	AC
Reference signal source	REF IN, SIN+ (Phase reference: Sine wave rise zero cross point)
Detection mode	SINGLE (single frequency measurement)
Harmonic	1/1 (fundamental wave measurement)
Measurement screen	Normal (displays the measured value, bar graph, and main settings)
Measurement data	DATA1 - DATA2: R - θ (signal magnitude - phase)

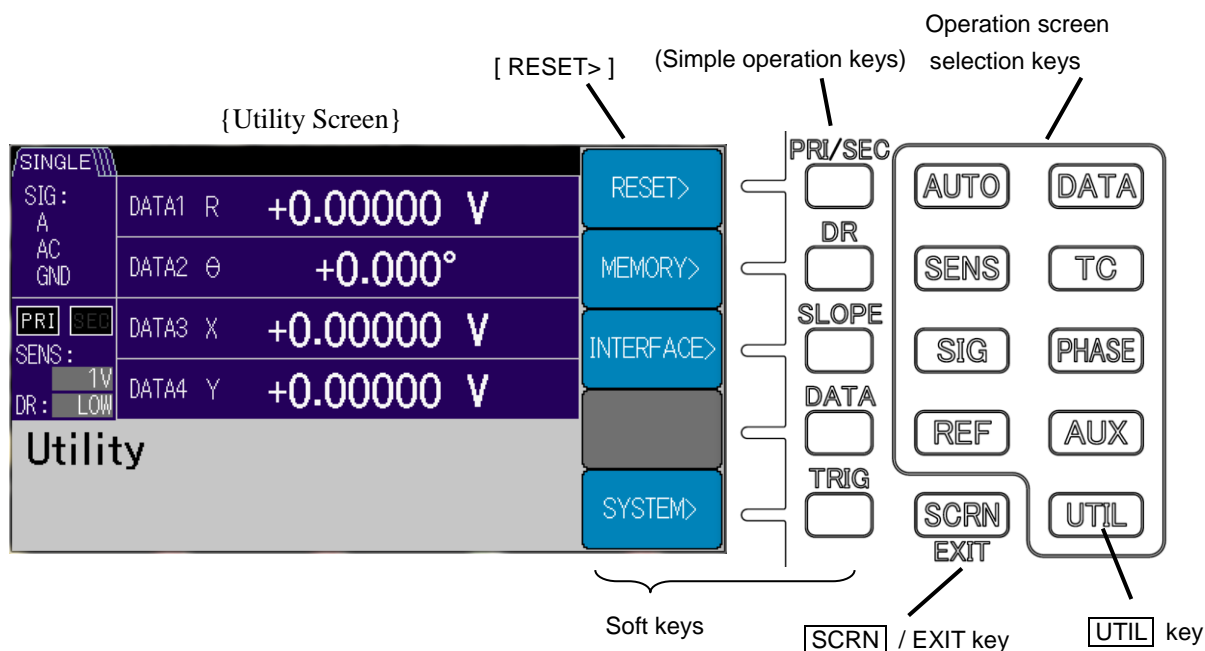

2) Connecting the Measured Signal and Reference Signal

Connect both the measured signal and reference signal prior to "3) Auto Setting." To use a lock-in amplifier, in general, a reference signal serving as a reference for the frequency and phase is required.

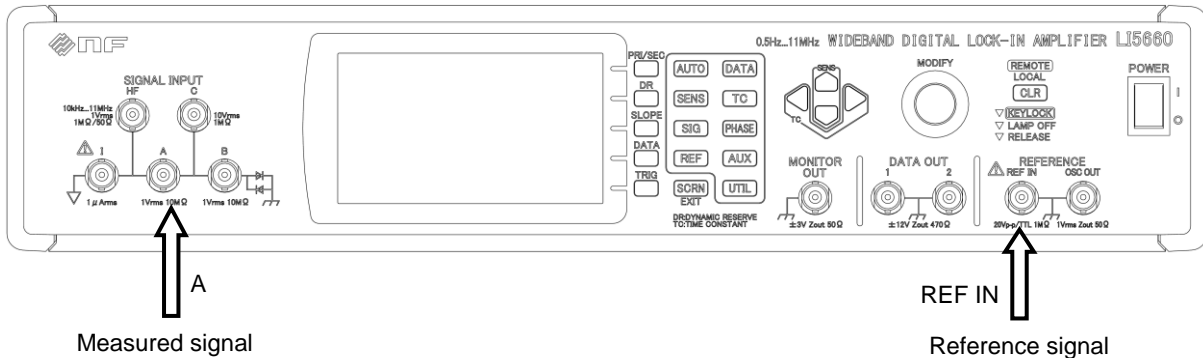

The following specifications are used for this explanation.

- Measured signal: Single-ended, and noise is at the level where the waveform can be identified
- External reference signal: Sine wave or square wave (duty \cong 50%) of order of several Vp-p

Other signal input connectors and other reference signals are selected in each setting screen and operation screen.

Go to another operation screen

For details on signal input, SIG key

For details on reference signal, REF key

Return to the measurement screen: SCRN / EXIT key

3) Auto Setting

- To perform auto setting, press **AUTO** key to {Auto Setting Screen}, and then press the [MEASURE] soft key.

This performs auto setting in the following order.

- a) Time constant filter (time constant and attenuation slope)
 - Performs auto setting according to the frequency of the reference signal.
- b) Sensitivity (signal full scale) and dynamic reserve
 - It takes time because the adjustment is performed one step at a time according to the signal and noise levels.
- c) Phase (phase shift amount of the reference signal)
 - Adjusts the phase shift amount so the Y output and θ output become zero.
 - At this point, the X output becomes equal to signal magnitude R. This X output has the advantage that it is more immune to the random noise than the R output.

When the auto setting is completed, the screen returns to the measurement screen.

4) Manual Adjustment

If the measurement fails in the auto setting, use the manual adjustment.

The following parameters can be adjusted also in the measurement screen.

Sensitivity (SENS)

Can be selected with the up/down keys.

Select the sensitivity so the measured value becomes close to the full scale without exceeding the specified level (over-level). If saturation occurs anywhere in the signal path inside the device, an icon (red) for INPUT, OUTPUT, etc. is displayed in the status area at the top of the screen. A correct value cannot be obtained in this state.

Time Constant (TC)

Can be selected with the left/right cursor keys.

If the measured value fluctuates due to noise, increase the time constant.

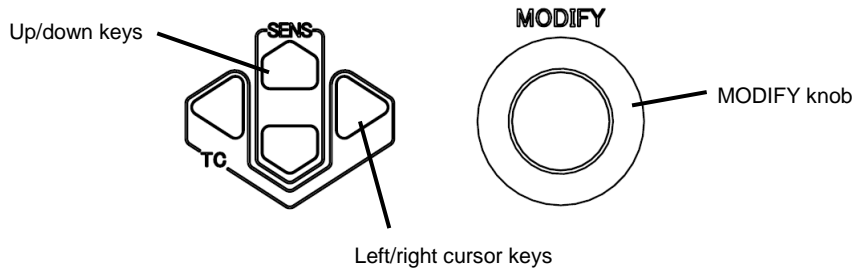

5) Select the measurement data

In the measurement screen, the value in DATA1 and DATA2 can be selected from R-θ and X-Y using the / DATA key.

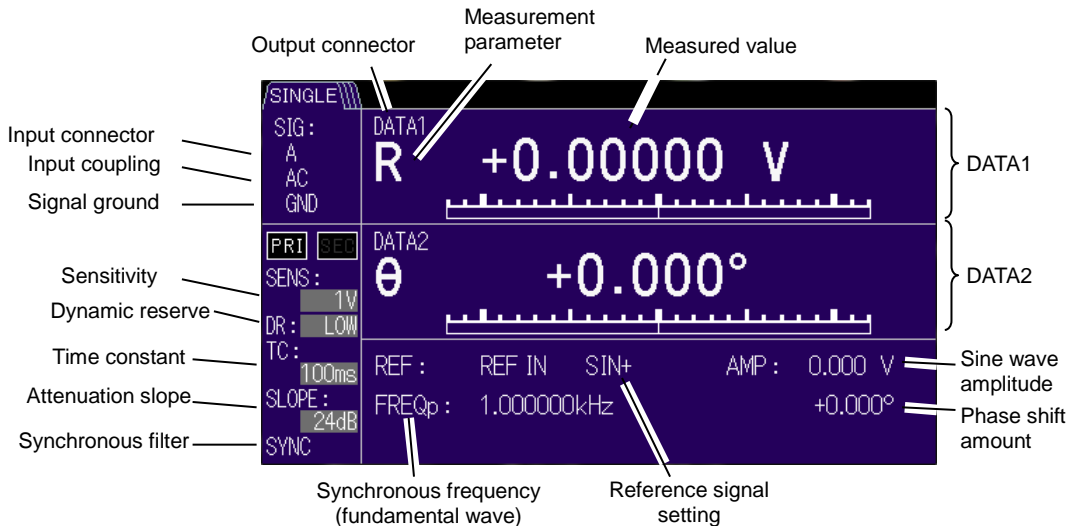

Note that the display can be switched to the expanded display and details display using the / SCRN key.

For details, refer to "3.3 Overview of the Measurement Screen"

6) Advanced Settings

To perform other advanced settings, press the operation screen selection key to go to each operation screen.

For details, ☞ "3.4 Overview of the Operation Screen", "3. Panel Operation List", or "5. Advanced Operations".

When the measured value exceeds the specified level (over-level) even if it does not reach the full scale, increasing the dynamic reserve (DR) may enable measurement to be performed successfully.

For details, ☞ "4.7 Sensitivity and Dynamic Reserve Setting"

When you have confirmed that the measured value has sufficiently stabilized, press the [PHASE] soft key in the AUTO key: {Auto Setting Screen} so that you can adjust the phase correctly ($\theta = 0$, $Y = 0$).

For details on manual adjustment,

☞ PHASE key: {Phase Adjustment Screen} "4.8 Phase Adjustment"

4.3 Measurement Parameter Setting, Output, and Display

The following shows how to specify the measurement parameters to output and display in DATA1 to DATA4.

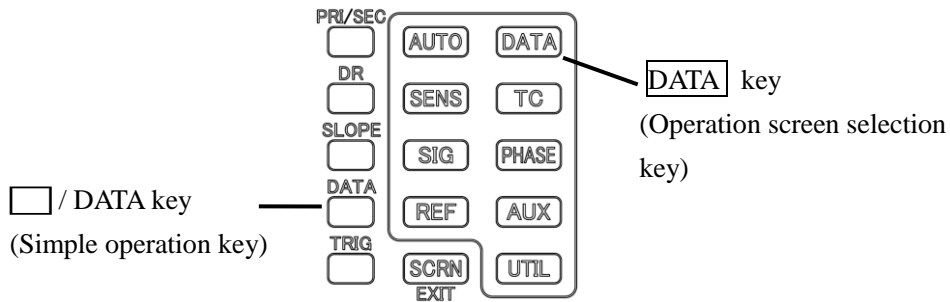

1) Operation in the Measurement Screen

Any of the following can be set only in DATA1 and DATA2 using the □ / DATA key.

DATA1 - DATA2: R-θ or X-Y (which are sequentially switched)

2) Operation in the Operation Screen

First press the □ DATA key to go to the following {Output Signal Selection Screen}.

For details on the output signal settings, refer to "3.6.2 □ DATA : {Output Signal Setting Screen}"

{ Output Signal Setting Screen }

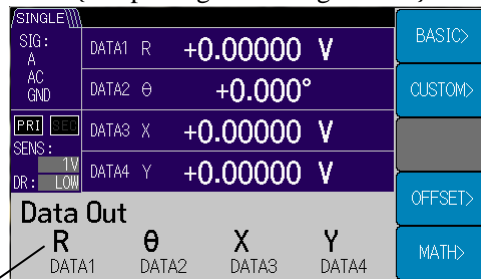

Current DATA 1, DATA2, DATA3, and DATA4 Output / Display Parameters

{ Basic Measurement Parameter Setting Screen }

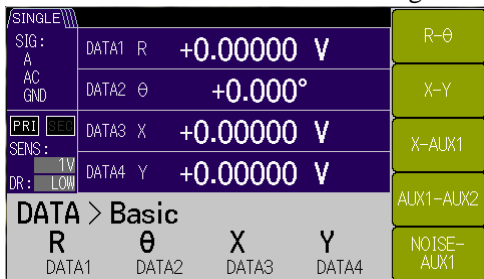

Next, press the [BASIC >] soft key to go to the {Basic Measurement Parameter Setting Screen}, where the basic combination soft key is displayed.

The soft key display content is specified in DATA1 and DATA2.

Press the [X-Y] soft key to set X in DATA1 and Y in DATA2.

DATA3 and DATA4 are not changed.

{Custom Measurement Parameter Setting Screen}

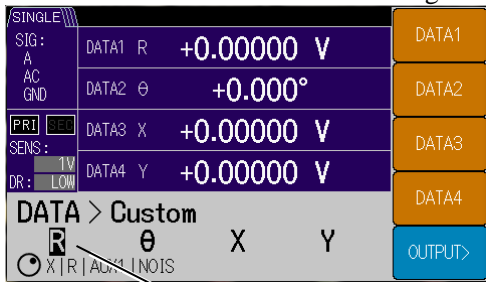

Setting range Current setting

Press the [CUSTOM>] soft key to go to the {Custom Measurement Parameter Setting Screen}, where any measurement parameter can be set in DATA1 to DATA4.

To change the parameter in DATA1, press the [DATA1] soft key to select the measurement parameter using the MODIFY knob or up/down keys.

If NOISE (noise density) is specified in DATA1, the [NOISE] soft key is displayed in the {Output Signal Selection Screen}, where the smoothing factor can be set.

For details on NOISE (noise density), see "5.6 Noise Density Measurement"

The following shows the meaning of each parameter.

Parameter	Description
X	In-phase component ($=R \cos \theta$)
Y	Quadrature component ($=R \sin \theta$)
R	Signal magnitude ($=\sqrt{X^2 + Y^2}$)
θ	Signal phase ($=\tan^{-1} Y/X$)
AUX1, AUX2	DC input voltage (rear panel)
NOISE	Noise density

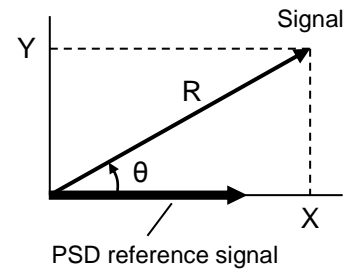

Values in DATA1 to DATA4 are displayed both in the measurement screen and operation screen.

Values and bar graphs in DATA1 and DATA2 are displayed in the Normal measurement screen and Large measurement screen.

The following shows an example of the Normal measurement screen

{Normal Measurement Screen}

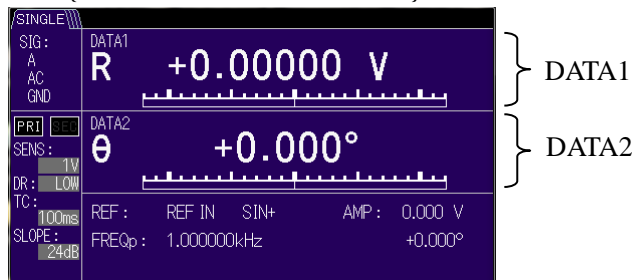

For details on each measurement screen, see "3.3 Overview of the Measurement Screen"

4.3 Measurement Parameter Setting, Output, and Display

Analog signals in DATA1 to DATA4 can be obtained from the corresponding DATA OUT 1 to DATA OUT 4 output connectors.

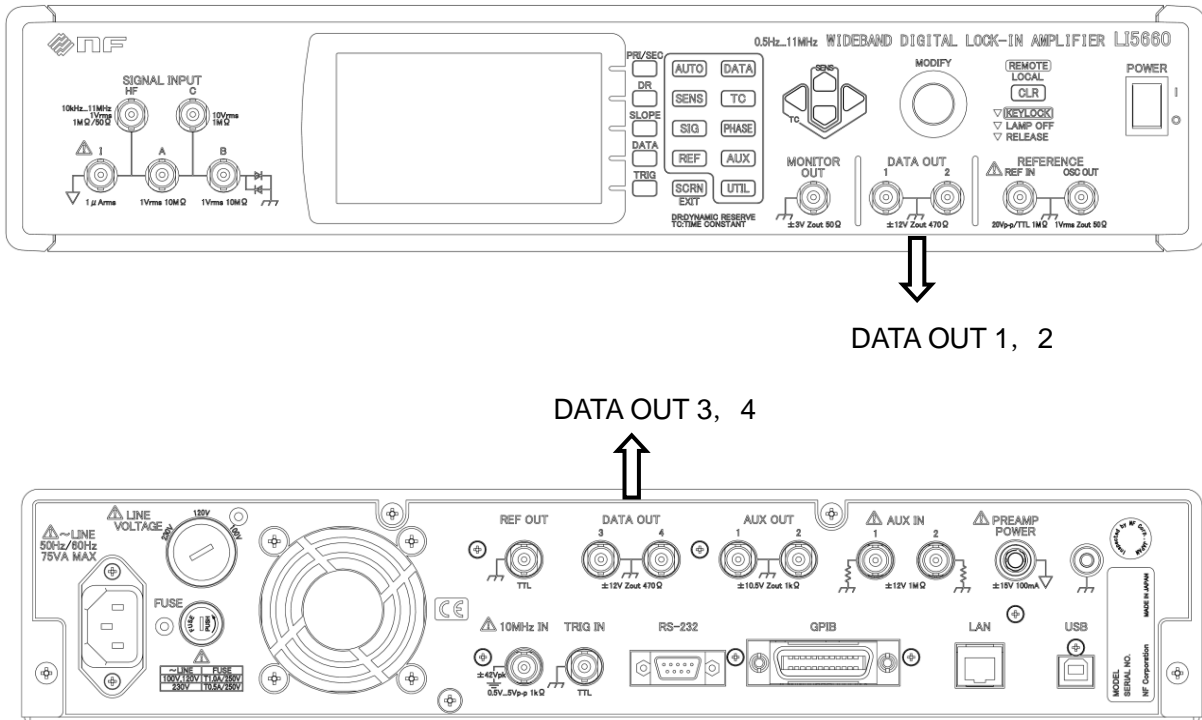

4.4 Reference Signal Setting and Connection

The following shows how to specify the reference signal serving as a reference of the frequency and phase.

*1: Only the LI5660 is equipped with the HF connector.

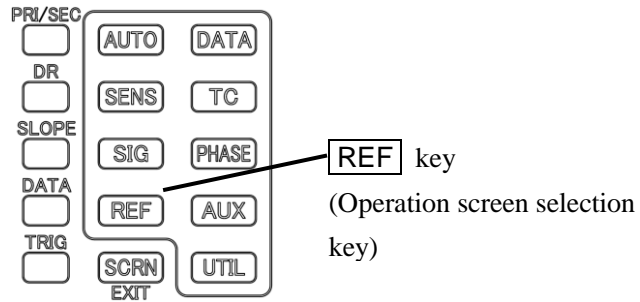

1) Select the Reference Signal Source

First press the **REF** key to go to the following {Reference Signal Setting Screen}.

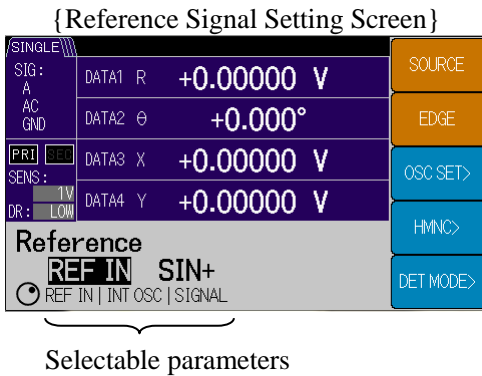

Next, press the [SOURCE] soft key to select the reference signal source from the following.

- REF IN (External reference signal)
Input the reference signal from the REF IN connector.
- INT OSC (Internal oscillator)
Generates the specified frequency inside the device. (External connection is not required)
- SIGNAL (Measurement signal)
Internally creates a synchronous signal from a measured signal at the A connector, etc.

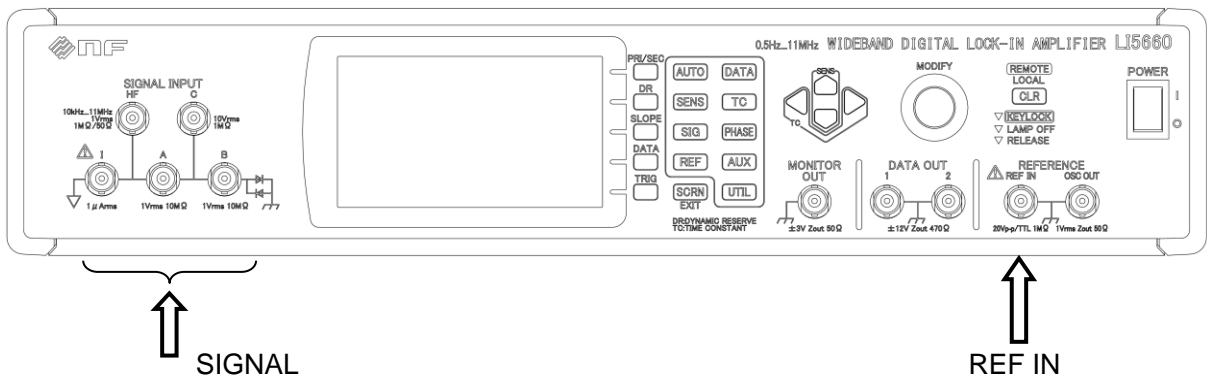

2) External Reference Signal (REF IN)

When the external reference signal is selected, the [EDGE] soft key is displayed.

Press the [EDGE] soft key to select the waveform and edge for the external reference signal.

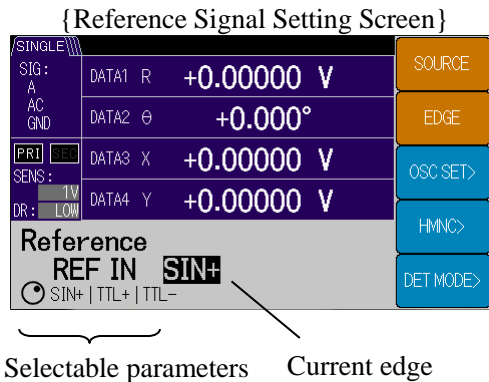

- SIN+ : Sine wave (0.3 to 20 Vp-p, 3.2 MHz max.),
Point to go through the average value in an upward direction.
- TTL+ : Square wave (TTL level), rising edge
- TTL- : Square wave (TTL level), falling edge

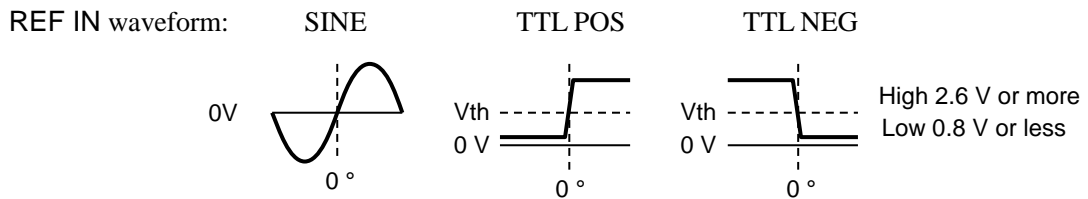

■ UNLOCK

If the external reference signal (REF IN) or measurement signal (SIGNAL) is set for the reference signal source and they are not synchronized, the UNLOCK status is displayed in the measurement screen.

The frequency and measured value displayed in the UNLOCK status do not correspond to the actual signal correctly so the values fluctuate.

If not synchronized, the frequency, magnitude, and waveform of the reference signal are considered to be different from the settings. Furthermore, if the noise included in the reference signal and the fluctuations of the frequency and amplitude are large, they may not be synchronized.

3) Internal Oscillator (INT OSC)

{ Oscillator Setting Screen }

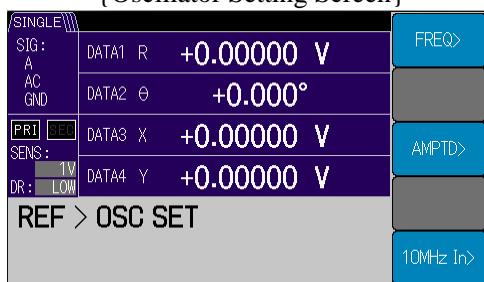

To use the internal oscillator, press the [OSC SET >] soft key to go to the { Oscillator Setting Screen }.

Then set the frequency and output amplitude (for OSC OUT) of the internal oscillator.

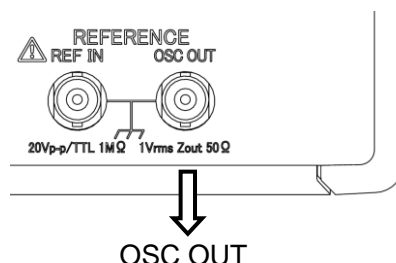

{ Frequency Setting Screen }



Setting range Current setting

Press the [FREQ >] soft key to go to the { Frequency Setting Screen } and set the frequency using the cursors and MODIFY knob.

{ Amplitude Setting Screen }

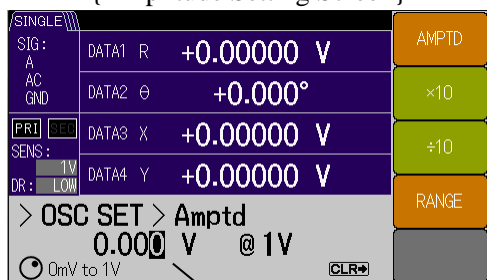

Setting range Current setting

Press the [AMPTD >] soft key to go to the { Amplitude Setting Screen } and set the amplitude using the cursors and MODIFY knob.

The output range (10 mVrms, 100 mVrms, 1 Vrms) can be set using the [RANGE] soft key.

A sine wave at the set frequency and amplitude is output from OSC OUT on the front panel and a square wave signal at the TTL level synchronized with OSC OUT connector is output from REF OUT connector on the rear panel.

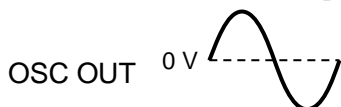

1 Vrms max
(Fixed to 0 Vrms at >3.2 MHz)

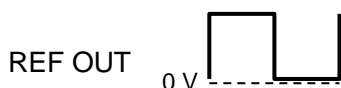

3.3 Vp-p nominal value
(Fixed to the High or Low level at >3.2 MHz)

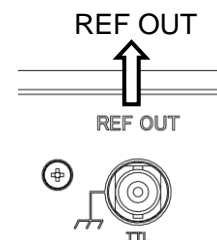

If the frequency is increased, a phase shift occurs between OSC OUT and REF OUT.

The amplitude for the internal oscillator output OSC OUT (sine wave) can be set regardless of the reference signal source.

The output amplitude is fixed to 0 Vrms at a frequency > 3.2 MHz regardless of the amplitude setting. At this point, the rear panel REF OUT (square wave) signal is fixed to the high level or low level.

If the amplitude range is switched, a brief glitch (dip or peak) occurs.

If the detection mode is DUAL2 and CASCADE, and the secondary frequency is set to output, the set frequency of the secondary frequency is output regardless of the reference signal source.

■ Restrictions (When Using the HF Connector*1)

If the HF connector is selected, the amplitude cannot be set. Furthermore, the output is 0 Vrms.

■ Crosstalk Reduction

If OSC OUT (sine wave) and REF OUT (square wave) are not in use and the amplitude for OSC OUT is set to 0 V, the crosstalk from the reference signal to the measured signal can be reduced.

4) Measurement Signal (SIGNAL)

To use the reference signal source as SIGNAL and synchronize it with the measured signal, first press the [OSC SET>] soft key to go to the {Oscillator Setting Screen}. Next, press the [FREQ>] soft key to go to the {Frequency Setting Screen} and set the frequency as close to the measured signal as possible using the cursors and MODIFY knob. If the frequency is far away from it, synchronization may be impossible or may take time.

If large noise is included in the input signal, set the time constant filter properly to reduce the influence of the noise. If stable measured values cannot be obtained, synchronization may be impossible.

■ Restrictions (When Using the HF Connector*1)

If the HF connector is selected, SIGNAL cannot be selected regardless of the measured signal frequency.

5) Actions and Output of the Internal Oscillator

The internal oscillator acts as follows depending on the reference signal source.

Reference signal source	Action of the internal oscillator
REF IN	Synchronized with external reference signal REF IN.
INT OSC	Oscillates at the frequency set by a value. If the reference signal source is switched to another one, the internal oscillator switches the frequency to the frequency and phase of the new reference signal source. However, the frequency set by a value is stored. If the reference signal source is returned to INT OSC, the previous frequency (set by a value) is restored.
SIGNAL	Synchronized with the measured signal (A connector, etc).

4.5 Input Connector Setting and Connection

The following shows how to set the measurement signal input connector.

*1: Only the LI5660 is equipped with the C and HF connectors.

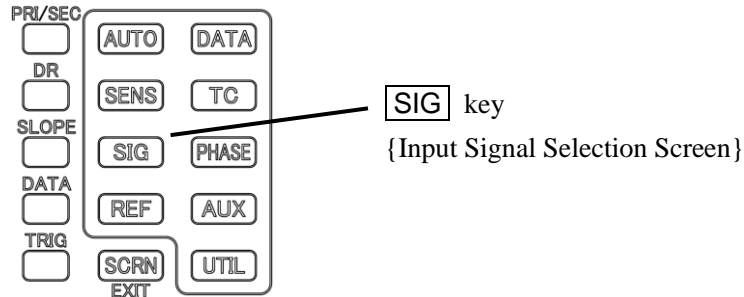

1) Select the Signal Input Connector

First press the **SIG** key to go to the following {Input Connector Selection Screen}.

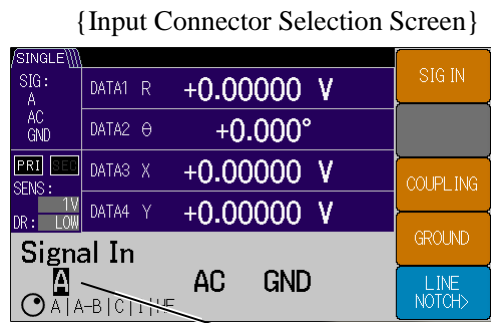

- A Voltage (1 Vrms max.)
- A-B Voltage (Differential, 1 Vrms max.)
- C Voltage (10 Vrms max.)*¹
- I Current (1 μArms max.)
- HF Voltage (10 kHz to 11 MHz, 1 Vrms max.)*¹

Selectable parameters Current input setting

Connect the cable to the selected input connector.

Do not connect an unnecessary cable to the unselected input connector. An unnecessary signal (interference) from the unnecessary cable may be mixed into the measured signal.

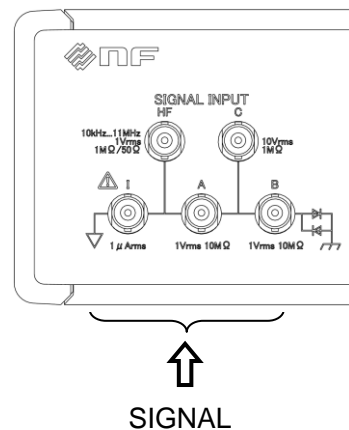

2) A

A (A connector) is the most generally used input connector for single-ended voltage signal.

Voltage sensitivity : 10 nV to 1 V (RMS value of signal)

Frequency range : 0.5 Hz to 3.2 MHz

Input impedance : 10 MΩ (nominal value), 50 pF in parallel (supplementary value)

Maximum input voltage : ±3V (between signal and ground)

If the signal significantly exceeds the maximum input voltage range, the input connector may temporarily be separated from the inside for protection.

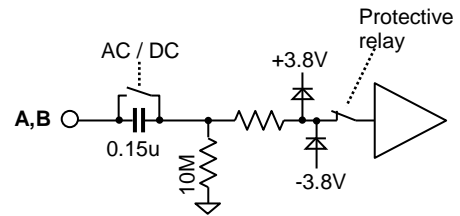

■ Noise Figure (NF)

Since an amplifier generates noise inside, the S/N ratio deteriorates wherever an amplifier is used. A noise figure indicates the extent to which the S/N ratio deteriorates. It indicates that the smaller the NF is the better the noise performance is.

$$NF [dB] = \text{output S/N ratio [dB]} - \text{input S/N ratio [dB]}$$

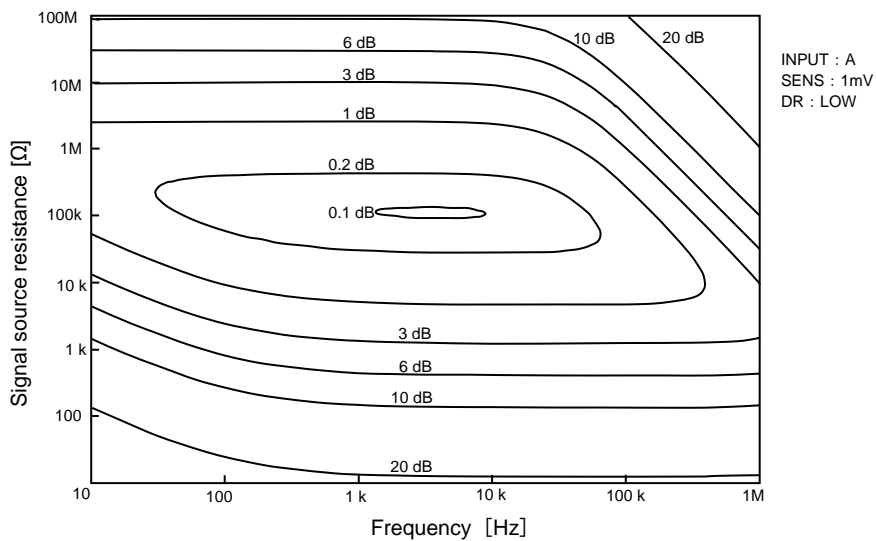

Figure 4-1 Noise Figure (Supplementary Values)

The NF varies depending on the frequency and signal source resistance. It depends on not only the input capacity but also the cable length at a high frequency.

Furthermore, the signal source resistance at which the NF is the minimum value is called the optimum signal source resistance. However, even if a resistor is installed in series with the signal source resistance to achieve the optimum signal source resistance, the S/N ratio is not improved.

In particular, if noise must be low, use a proper preamplifier. Install a preamplifier as close to the signal source as possible to reduce the influence of common-mode noise.

Ground the preamplifier close to the signal source.

3) A-B

A-B is a differential connection between A connector and B connector. Even if there is common-mode noise in the ground potential of the signal source and the signal reference potential of the LI5655 / LI5660, the influence on the measurement can be reduced. For A-B, B connector is used as a reference to measure the voltage signal of A connector.

Voltage sensitivity : 10 nV to 1 V (RMS value of signal)

Frequency range : 0.5 Hz to 3.2 MHz

Input impedance : 10 M Ω (nominal value), 50 pF in parallel (supplementary value)

Maximum input voltage : ± 3 V (between signal and ground, between signal A and B)

■ CMRR (Common Mode Rejection Ratio)

The capability to remove the signal (noise) component commonly added to both inputs is called CMRR (Common Mode Rejection Ratio).

The CMRR varies depending on the sensitivity (SENS), dynamic reserve, and input coupling (AC | DC).

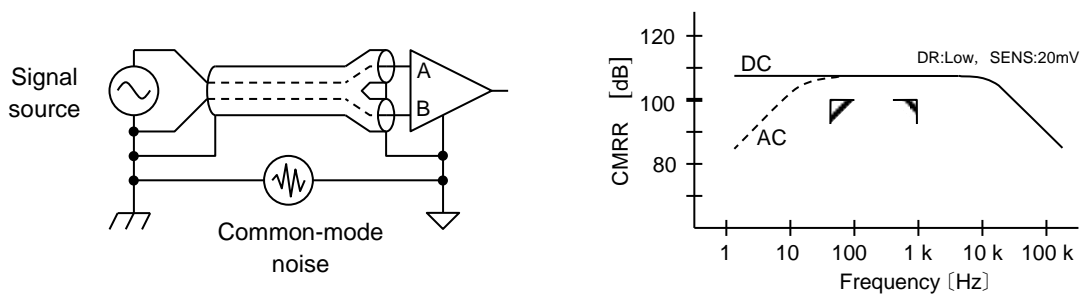

Figure 4-2 CMRR (Supplementary Values)

CMRR Deterioration Factors

- High signal source impedance and mismatch of the signal source impedance

If the signal source impedance is low enough, there is no problem. However, if the signal source impedance is high, the mismatch of the signal source impedance between A and B causes the CMRR to deteriorate significantly.

- Mismatch of the cable capacity

If the type and length of both signal cables vary, the capacity to ground of each signal line also varies, so the CMRR deteriorates at a high frequency.

4) C*¹

C (C connector) is an input connector for a single-ended voltage signal for measuring the voltage range that cannot be measured directly using the A connector; for example, a large output voltage signal of the preamplifier, or large voltage signals including noise.

Voltage sensitivity : 1 mV to 10 V (RMS value of signal)
 Frequency range : 0.5 Hz to 3.2 MHz
 Input impedance : 1 M Ω (nominal value)
 50 pF in parallel (supplementary value)
 Maximum input voltage : ± 30 V (between signal to ground)

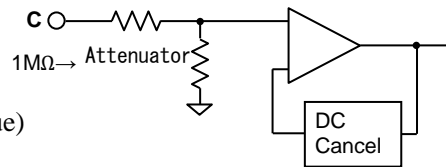

■ Restrictions (When Using C)

The C connector is always the DC coupling regardless of the input coupling (AC | DC) setting. However, the action is almost the same as the AC coupling, because the DC component included in the input is corrected by the DC cancel circuit.

5) I

I (I connector) converts a current signal to a voltage signal using a current - voltage converter and measures it.

If I is selected, select the current - voltage conversion gain considering the magnitude and frequency of the current signal.

For details on the specifications, see "9.1 Measured signal system b) Current measurement"

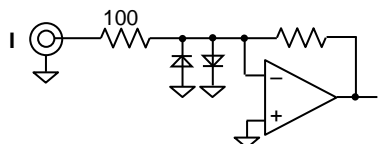

For the polarity of the current, the direction in which the current flows from the I connector to the signal source is positive.

{Input Connector Selection Screen}

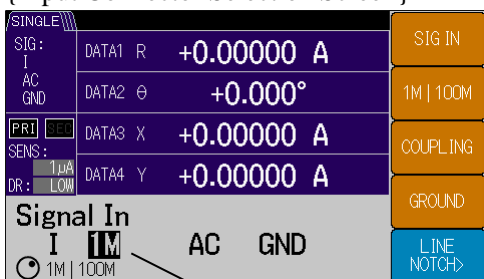

Settable parameters

Current setting

Conversion gain 1 M:

Conversion gain 10^6 V/A

Current sensitivity 100 fA to 1 μ A

Bandwidth 1 MHz *2

Conversion gain 100 M:

Conversion gain 10^8 V/A

Current sensitivity 10 fA to 10 nA

Bandwidth 10 kHz *2

*2: Cs is the capacity of the signal source (including the connection cable)

-3 dB bandwidth when Cs=150 pF (supplementary value)

For the current input, the frequency characteristic changes by Cs. Furthermore, when Cs increases, the noise density increases at a high frequency. Depending on the sensitivity and dynamic reserve settings, the level may be exceeded (over-level) inside the LI5655 / LI5660 due to the influence of noise. Adjust the sensitivity and dynamic reserve as needed.

Furthermore, to avoid the influence of noise as much as possible, install a current input amplifier (NF Corporation's WIDEBAND CURRENT AMPLIFIER SA-600 series, etc.) as close to the signal source as possible to convert a current to a voltage and connect it as a voltage signal to the A or C *1 input.

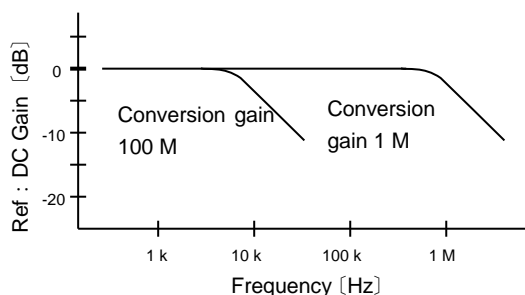

Figure 4-3 I Input Frequency Characteristics (Supplementary Values)

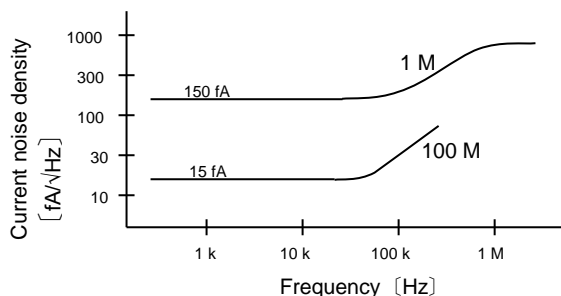

Figure 4-4 I Input Referred Noise Density (Supplementary Values)

6) HF *1

HF (HF connector) is an input connector for a single-ended voltage signal for measuring frequencies above 3 MHz. To use the HF connector, select the input impedance (1 MΩ | 50 Ω).

Voltage sensitivity : 1 mV to 1 V (RMS value of signal)

Frequency range : 10 kHz to 11 MHz

Input impedance : 1 MΩ (nominal value), 50 pF in parallel (supplementary value),
or 50 Ω

Maximum input voltage : ±3V (between signal to ground)

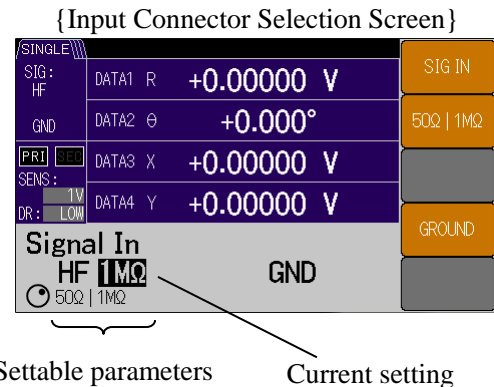

If the frequency exceeds 1 MHz and the reflection of the signal cannot be ignored, it is recommended to set both the characteristic impedance of the connection cable and the input impedance of the HF connector to 50 Ω.

■ Restrictions (When Using the HF Connector)

- The anti-aliasing filter is bypassed. Therefore, remove unnecessary noise at high frequencies by installing a proper low pass filter, band pass filter, tuning amplifier, etc. at the front. Otherwise, the output may fluctuate significantly.
- The HF connector retains the reference signal setting independently from other input connectors. If the input connector is switched from another one, the frequency of the reference signal source, external reference signal, and internal oscillator, etc. is switched to the HF connector setting.
- The external reference signal is limited to the TTL-level square wave. It does not work correctly with the sine wave.
- The HF connector is always the AC coupling.

■ About Anti-aliasing Filter

The LI5655 / LI5660 converts an analog signal to a digital signal at 25 M samples/s and then performs digital signal processing. The anti-aliasing filter incorporated into the LI5655 / LI5660 removes frequency components above 3 MHz. Thus, noise at high frequencies is aliased close to the signal frequency by sampling to prevent apparent noise from increasing.

7) Input Coupling *1

If A, A-B, or I is set, the input coupling [AC | DC] can be selected.

The specifics vary depending on the input connector. For details, refer to the figure below.

The C connector is always the DC coupling, but the DC component is automatically canceled.

The HF connector is always the AC coupling.

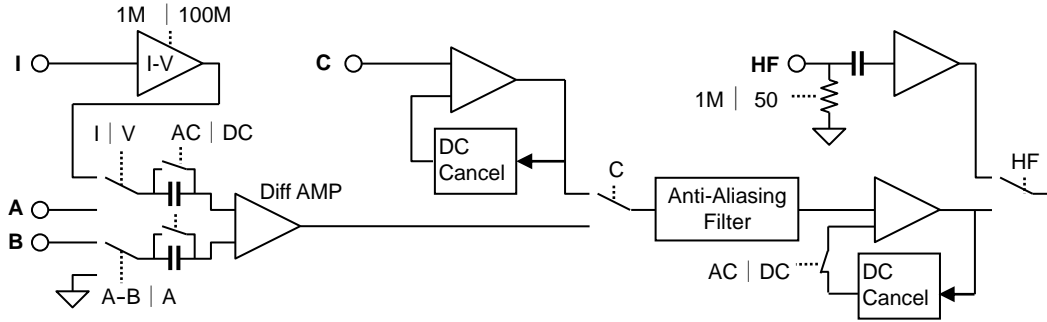

- AC (AC coupling)

When a large DC component is included in the input signal, it is possible to measure the minute AC signal by increasing the sensitivity by cutting the DC component. Increasing the sensitivity without cutting off the DC component may cause internal circuitry to saturate.

Although the frequency characteristic of the AC coupling (DC cancel function) is corrected, measurement accuracy decreases near the lower limit frequency. Also, transient response settling time is required when signal changes.

Please use AC coupling when the frequency is 1 Hz or more.

- DC (DC coupling)

For AC coupling, signal attenuation and phase error may increase at low frequencies.

For this reason, it is recommended to use DC coupling for frequencies below 1 Hz even for AC signals that do not contain DC components.

However, since the DC component is also regarded as noise, sufficient care is required for dynamic reserve and sensitivity setting.

8) Select the Ground

The signal ground [FLOAT | GND] can be selected.

FLOAT : Floating from the enclosure (ground). Impedance to enclosure: 10 k Ω

GND : Connected to the enclosure. Impedance to enclosure: 11 Ω

If the signal grounds for the signal source and the LI5655/ LI5660 are grounded at separate locations, a potential difference between grounds (common-mode noise) may cause a noise current to flow into the ground loop and a voltage drop in the signal ground line may be added as noise to the signal. In such a case, select FLOAT.

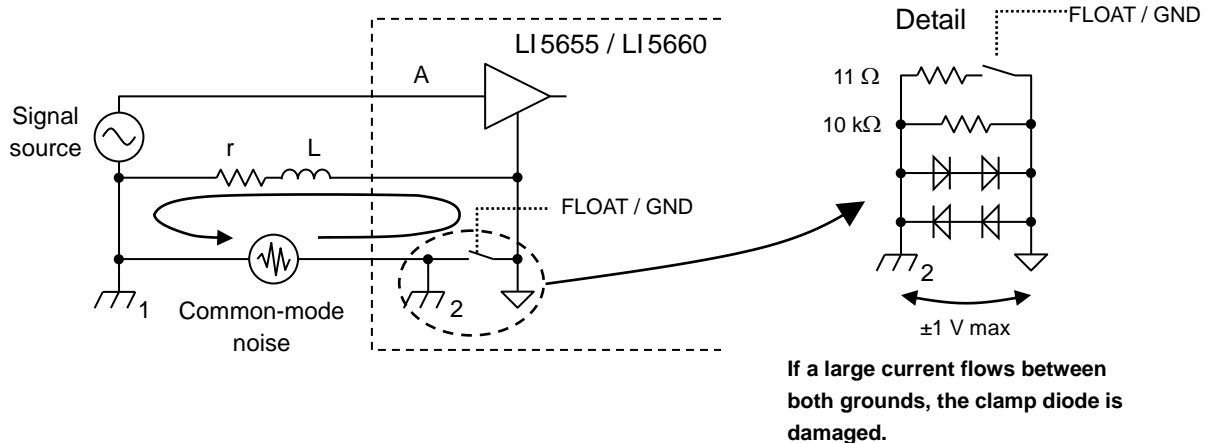

If the signal source is not grounded, select GND and connect the signal ground to the enclosure of the LI5655 / LI5660 to maintain the stability of the potential reference.

If the signal source is not grounded and the LI5655 / LI5660 is also in the FLOAT state, the impedance to ground increases and the potential (to ground) of the signal ground fluctuates, for example, due to an electrostatic coupling with the noise source. The fluctuation of the signal ground potential is an isolation-mode rejection ratio whose characteristics are similar to those of the CMRR, which adversely affects the signal measurement.

If the environmental noise is large

- If there is common-mode noise in the ground potential of the signal source and the signal reference potential of the LI5655 / LI5660, use the differential connection (A-B).
- If the ground of the reference signal line (enclosure of the LI5655 / LI5660) is shared by the ground of the signal source to be measured, isolate the signal using a transformer.
- If noise comes in via the power supply or ground of an external device, the noise current can be reduced by installing a noise cut transformer (NF Corporation's Noise Filter Transformer NT series, etc.) in the power line from the outlet. Furthermore, noise can be reduced in some cases by connecting both grounds with low impedance to reduce the potential difference between grounds.

4.6 Time Constant Filter Setting and Characteristics

The following shows how to set the time constant filter and attenuation slope.

The time constant filter characteristic is determined by the following three parameters.

- Time constant (TC)
- Attenuation slope (SLOPE)
- Synchronous filter (SYNC)

Set the filter to remove a ripple caused by the frequency and noise of the signal, or the phase sensitive detector (PSD).

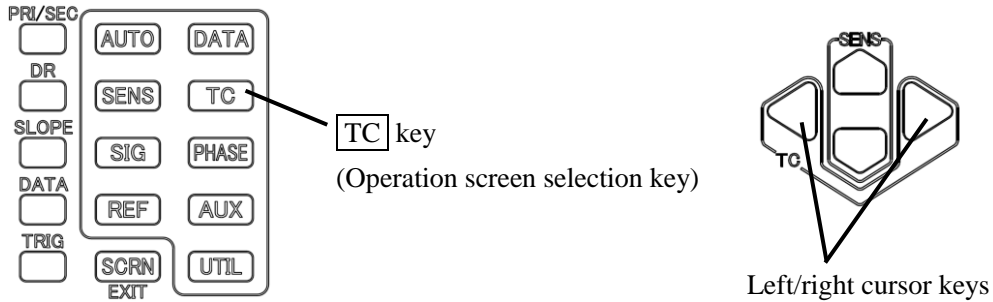

4.6.1 How to Set the Filter

In the measurement screen, the time constant can be set in the range of 1 μ s to 50 ks using the left/right cursor keys.

In the operation screen, first press the [TC] key to go to the following {Time Constant Filter Setting Screen}.

1) Time Constant Setting

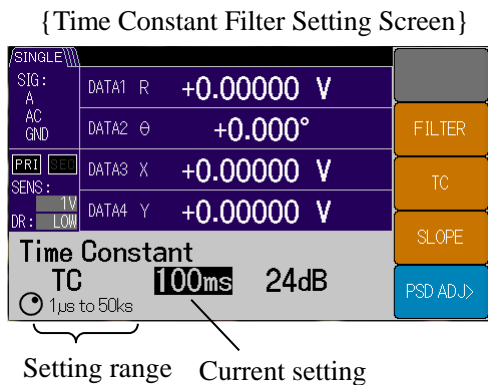

Press the [TC] soft key to set the time constant using the MODIFY knob or up/down keys.

The setting range is 1 μ s to 50 ks (1-2-5 sequence).

2) Attenuation Slope Setting

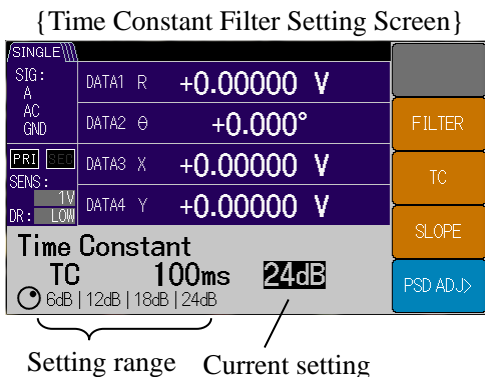

Press the [SLOPE] soft key to set the attenuation slope using the MODIFY knob or up/down keys.

The setting range is 6, 12, 18, 24 dB/oct.

3) Select the Filter

{ Time Constant Filter Setting Screen }

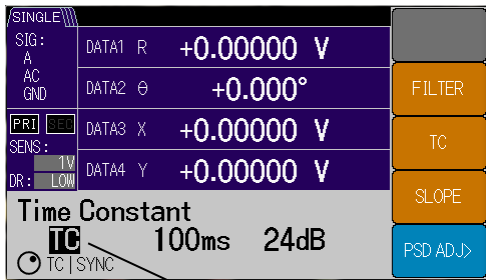

Press the [FILTER] soft key to set the normal filter (TC filter) and SYNC (synchronous filter) using the MODIFY knob or up/down keys.

Setting range Current setting

4.6.2 Time Constant Filter Characteristics

1) Normal Filter

If the synchronous filter function is set to OFF, the characteristics are those of cascade-connected first-order low pass filters (cutoff frequency f_c). The attenuation slope per row is 6 dB/oct (20 dB/dec). This characteristic is that if the frequency is doubled in the attenuation region, it is attenuated to 1/2 (if the frequency is increased by 10 times, it is attenuated to 1/10). Cascade-connect the filters in 1 to 4 rows to obtain an attenuation slope of 6 to 24 dB/oct (20 to 80 dB/dec).

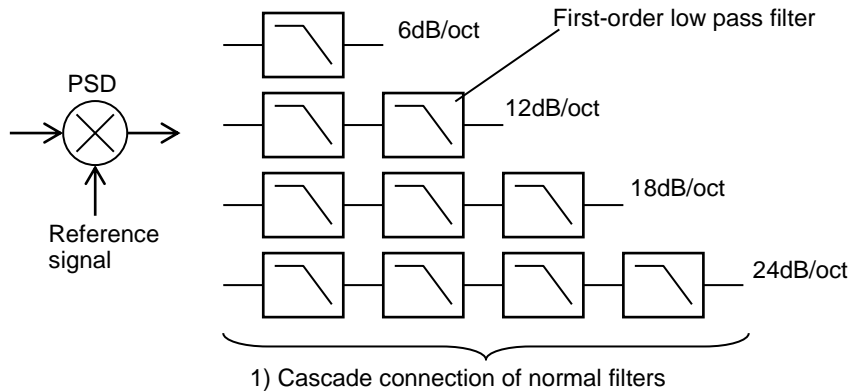

a) Frequency Characteristics

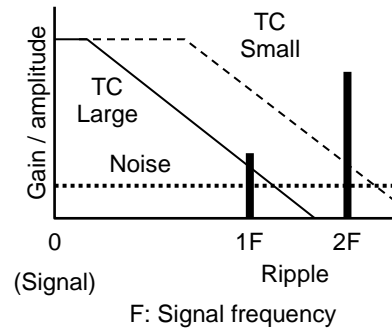
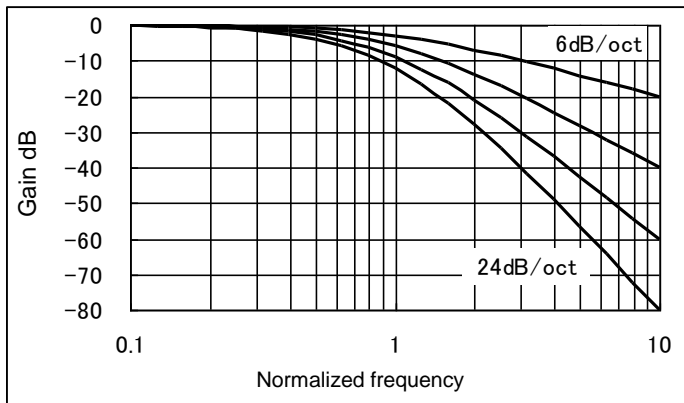

Normalized frequency = |frequency difference from signal to reference| / cutoff frequency (f_c)
 $f_c = 1 / (2\pi T)$, T indicates the time constant.

b) Equivalent Noise Bandwidth B_N

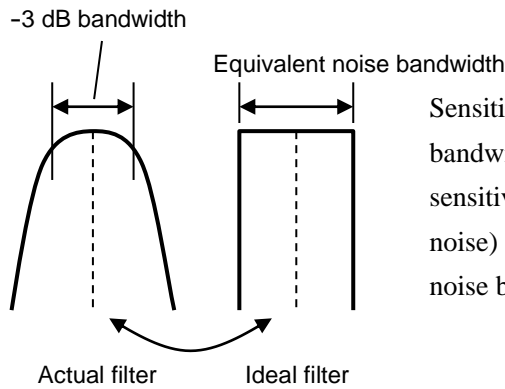

Sensitivity to white noise is represented by an equivalent noise bandwidth. The bandwidth of an ideal filter where the sensitivity to noise (in other words, the RMS value of output noise) is equal to that of the actual filter is called an equivalent noise bandwidth of that filter.

Equivalent noise bandwidth B_N of the LI5655 / LI5660 is double the equivalent noise bandwidth of a low pass filter that is determined by time constant T and attenuation slope.

$$B_{N6} = \frac{1}{2T}, \quad B_{N12} = \frac{1}{4T}, \quad B_{N18} = \frac{3}{16T}, \quad B_{N24} = \frac{5}{32T} \quad (\text{corresponding to 6, 12, 18, and 24 dB/oct})$$

RMS value V_m of noise included in the output (measured value) can be obtained using the following expression, where V_n indicates the noise density of the input and B_N indicates the equivalent noise bandwidth.

$$V_m = V_n \times \sqrt{B_N}$$

c) -3 dB Bandwidth B_{3dB}

$$B_{3dB} = \sqrt{\sqrt[m]{2} - 1} / (\pi T)$$

T indicates the time constant, and $m=1, 2, 3, 4$ (corresponding to 6, 12, 18, 24 dB/oct)

d) Step Response Time

Response $y(t)$ to supplying a step signal to the low pass filter after phase sensitive detection is represented by the following expression.

$$y(0) = 0, \quad y(t) = 1 - \left\{ \sum_{n=1}^m \frac{t^{n-1}}{T^{n-1} (n-1)!} \right\} e^{-\frac{t}{T}} \quad \text{However, } t > 0.$$

T indicates the time constant, and $m=1, 2, 3, 4$ (corresponding to 6, 12, 18, 24 dB/oct)

Step Response Time

Response	SLOPE (dB/oct)			
	6	12	18	24
90 %	2.3 T	3.9 T	5.3 T	6.7 T
99 %	4.6 T	6.6 T	8.4 T	10.0 T
99.9 %	6.9 T	9.2 T	11.2 T	13.1 T

This is the case of an analog filter. Digital processing is used for the filter. Therefore the characteristic of this device when the time constant is small varies slightly from the above.

Step Response Waveform

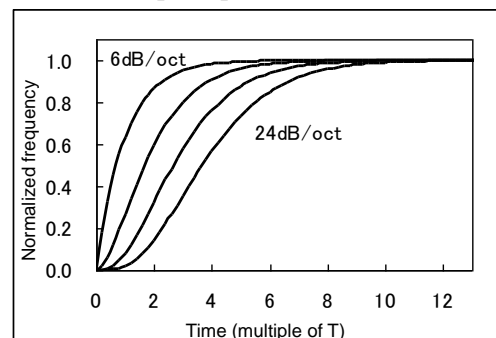

2) Synchronous Filter (SYNC)

If the synchronous filter function is set to ON, a moving average filter whose averaging section is equal to a multiple of the signal cycle is added to the time constant filter.

If the time constant is decreased in the normal filter, the ripple caused by detection is not attenuated.

Since the time constant must be increased to a certain extent even if noise is small, the output response is slow in particular at low frequencies.

An integer-cycle moving average filter significantly attenuates the ripple caused by detection.

Therefore, a high-speed response can be obtained by decreasing the time constant (almost corresponding to the averaging section) if noise is small.

If the time constant is smaller than the signal cycle, the step response is set to approximately 1 signal cycle.

Actually, the normal filter is placed at the rear stage of the moving average filter.

Therefore, if the time constant is increased, the response is closer to that of the normal filter (the ripple is attenuated more significantly).

Frequency characteristics of the moving average filter
(Example: Averaging section = 1 cycle)

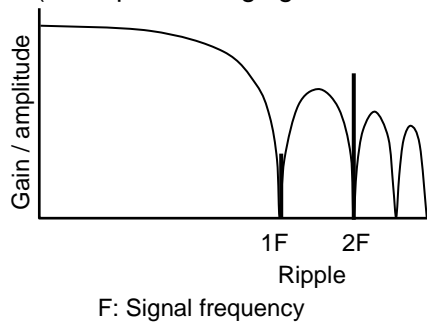

Configuration of the synchronous filter

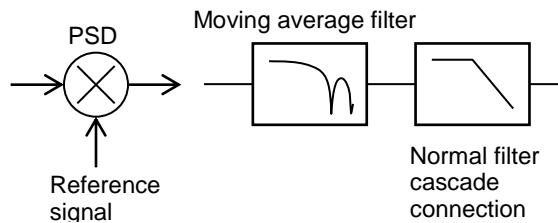

If you need a high-speed response, set 6 dB/oct for the attenuation slope. However, the output waveform looks slightly like a series of steps.

The practical upper limit frequency of the synchronous filter is about 1 MHz. If the signal frequency is increased, the averaging section may deviate slightly from the integer cycle and sufficient reduction of the ripple may not be possible.

4.6.3 Auto Setting of Time Constant

Press [TIME CONST] in the {Auto Setting Screen} (AUTO key) to automatically set the time constant and attenuation slope as shown below according to the frequency.

- Attenuation slope (SLOPE) = 24 dB/oct
- Synchronous filter (SYNC) = Valid if frequency \leq 100Hz, invalid if frequency > 100Hz
- Time constant (TC) = $10 \div (2 \times \pi \times \text{signal frequency})$
 - * However, the calculated value is rounded up to the nearest setting value.
The time constant range is $20 \mu\text{s} \leq \text{TC} \leq 20 \text{ s}$.
 - * Firmware version 1.60 or later

If the measurement fails using auto setting, use manual adjustment.

If the measured value fluctuates due to noise or insufficient ripple removal, increase the time constant.

If you need a faster response, decrease the time constant.

In general, noise reduction and response time can be balanced better if the attenuation slope is increased and the time constant is decreased. However, if the LI5655 / LI5660 is used in an automatic control loop, the control system may be unstable due to the characteristics of a high-order filter. In such a case, set 6dB/oct for the attenuation slope. If the ripple caused by detection may not be attenuated sufficiently, consider using the synchronous filter.

If a DC offset is included in the PSD input, a ripple of the same frequency as the signal frequency is included in the phase-detected output. A large time constant is required to remove it.

As a result, the response is slower.

The occurrence of this ripple can be suppressed and an unnecessarily large time constant does not need to be set by adjusting the PSD input offset to zero.

For details on the adjustment of the PSD input offset,  "5.7 PSD Input Offset Adjustment"

4.7 Sensitivity and Dynamic Reserve Setting

The following shows how to set the sensitivity (signal full scale) and dynamic reserve (noise margin).

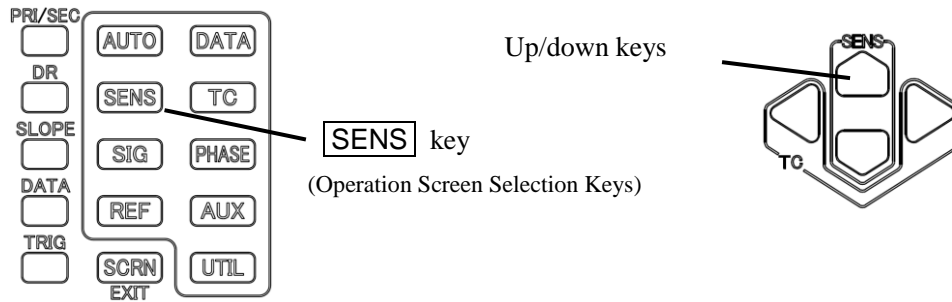

4.7.1 How to Set the Sensitivity

In the measurement screen, the sensitivity range can be set for each of the following input connectors using the up/down keys.

Input connector *4		Measurement setting	Sensitivity range *2
A A-B		Voltage sensitivity	10 nV to 1 V
		Voltage noise density	20 nV to 1 V *3
C *1		Voltage sensitivity	1 mV to 10 V
		Voltage noise density	1 mV to 10 V *3
I	1 M [V/A]	Current sensitivity	100 fA to 1 μA
		Current noise density	1 pA to 1 μA *3
	100M [V/A]	Current sensitivity	10 fA to 10 nA
		Current noise density	100 fA to 10 nA *3
HF *1		Voltage sensitivity	1 mV to 1 V
		Voltage noise density	1 mV to 1 V *3

*1: Only the LI5660 is equipped with the C and HF connectors.

*2: The magnitude of the signal that is displayed is the root mean square (RMS).

The sensitivity setting value is the full scale and the sequence is 1-2-5.

For details on the display range,

☞ "9.5 Measured Value Output and Display Section, e) Numeric display"

*3: When the noise density (NOISE) is displayed, add $\sqrt{\text{Hz}}$ to the unit that is displayed when you read it.

*4: The sensitivity settings are retained for each connector. The settings for the A and A-B connectors are commonly retained, and the settings for the 1 M and 100 M conversion of the I connectors are retained individually.

In the operation screen, first press the **[SENS]** key to go to the following {Sensitivity Setting Screen}.

1) Sensitivity Setting

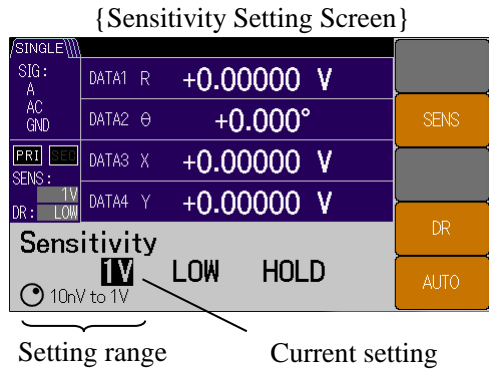

Press the [SENS] soft key to set the sensitivity using the MODIFY knob or up/down keys.

2) Dynamic Reserve Setting

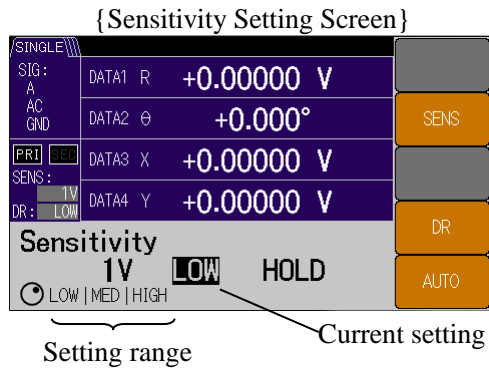

Press the [DR] soft key to set the dynamic reserve using the MODIFY knob or up/down keys. The setting parameters are LOW, MED, and HIGH. The margin for noise is larger on the HIGH side.

Set a minimum value for the dynamic reserve. The input referred noise is larger or the drift of the measured value is larger on the HIGH side.

■ Dynamic Reserve at a Specific Frequency

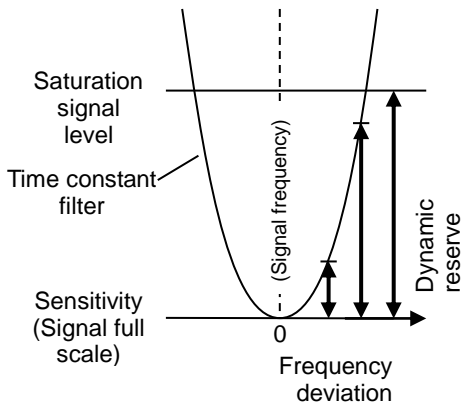

The dynamic reserve value depends on the saturation signal level inside the device at a specific sensitivity (signal full scale) and the characteristics of removing noise using the time constant filter. In other words, it depends on the frequency.

Dynamic reserve value at a frequency where noise is attenuated sufficiently by the time constant filter

For details, see "9.2 Phase Sensitive Detector Section, c)Dynamic Reserve (DR)

■ Dynamic Reserve for Random Noise

Random noise (wideband noise) is acceptable until its peak value reaches the saturation signal level inside the device. The RMS values of sine wave and noise are equal to each other, but the peak value of the noise is several times or more larger than that of the sine wave. Set the dynamic reserve considering the peak value.

3) Auto Sensitivity Adjustment Setting

Icon indicating auto sensitivity adjustment is running

{Sensitivity Setting Screen}/

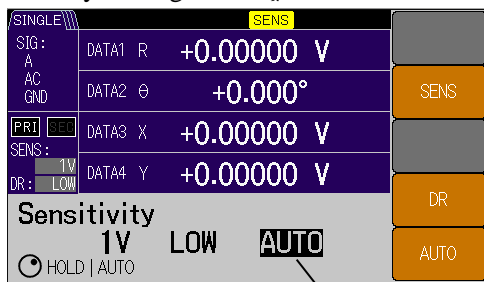

Settable parameters

Current setting

Press the [AUTO] soft key to set HOLD or AUTO for the auto sensitivity adjustment using the MODIFY knob or up/down keys.

AUTO continuously automatically adjusts the sensitivity and dynamic reserve according to the magnitude of the signal and noise.

HOLD retains the sensitivity and dynamic reserve settings. It sets the manual setting to ON.

■ Restrictions (Operations in AUTO Mode)

If any of the following operations is performed in AUTO, the auto sensitivity setting is forced to be changed to HOLD.

- When the offset value is changed using the [DATA] key and [OFFSET>] soft key.
- When the arithmetic processing function is changed using the [DATA] key and [MATH>] soft key.
- When a change is made to the time constant filter settings using the [TC] key.
- When a change is made to the input connector settings using the [SIG] key.
- When the phase shift amount is changed using the [PHASE] key.
- When a change is made to the reference signal settings using the [REF] key.
- When the sensitivity or dynamic reserve is changed from the measurement screen or operation screen.

4.7.2 Sensitivity and Dynamic Reserve Auto Setting

Press the [SENS] soft key in the {Auto Setting Screen} ([AUTO] key) to automatically set the sensitivity and dynamic reserve just once according to the magnitude of the signal and noise.

In the following cases, the auto setting is forced to be terminated after switching the sensitivity several times, so the sensitivity may not be set properly.

- When the signal fluctuates significantly
- When the noise is large
- When the signal is small

If the signal fluctuates significantly, perform the auto sensitivity setting and then perform the manual operation in a slightly larger range. If fluctuations due to noise are large, set a larger value for the time constant and attenuation slope and then perform the auto setting again. If the signal is small, set the sensitivity and dynamic reserve by manual operation.

4.7.3 Signal Over-level Display and Monitor Output

If an excessive signal level is detected anywhere on the signal path from the LI5655 / LI5660 input to output and measurement is impossible, an icon is displayed in the screen.

Over-level status	Description	Remedy
PROTECT	Voltage exceeding the maximum input voltage was detected in the A or B connector. Both the A and B connectors are internally separated temporarily for protection.	Lower the signal level applied to the A or B connector. Use the C connector. (For the LI5660 only)
IN/OUT	Both events described in INPUT and OUTPUT below occurred.	(See below)
INPUT	Over-level occurred in the AC amplification part from the signal input connector to PSD (primary PSD) input. The PSD input signal can be checked with the MONITOR OUT connector.	Increase the sensitivity (signal full scale). Increase the dynamic reserve. If a DC component is included in the input signal, use the AC coupling. Set the line filter to ON to attenuate the noise coming from the power supply.
OUTPUT	Over-level occurred in the signal processing part of the PSD output (time constant filter and DC amplification part). The output voltage range was exceeded as a result of an OFFSET, EXPAND, NORMALIZE, RATIO, or other arithmetic processing. Measurement parameters that are not output and displayed are also included in the scope.	Increase the time constant and attenuation slope to attenuate the noise. Increase the sensitivity (signal full scale). Cancel the arithmetic processing and check the original signals (X, Y, R, AUX IN 1). Then configure the setting again so the output does not exceed the maximum level.
AUX	Excessive input into the AUX IN 1 or AUX IN 2 connector.	Lower the signal level applied to the AUX IN 1 or AUX IN 2 connector.

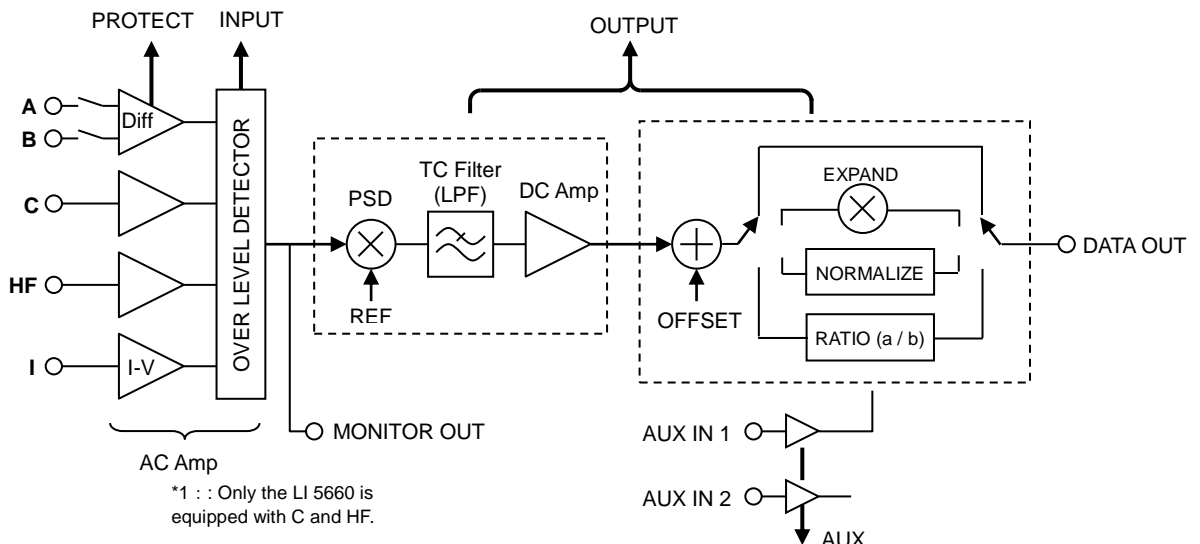

Over-level Detection Block Diagram

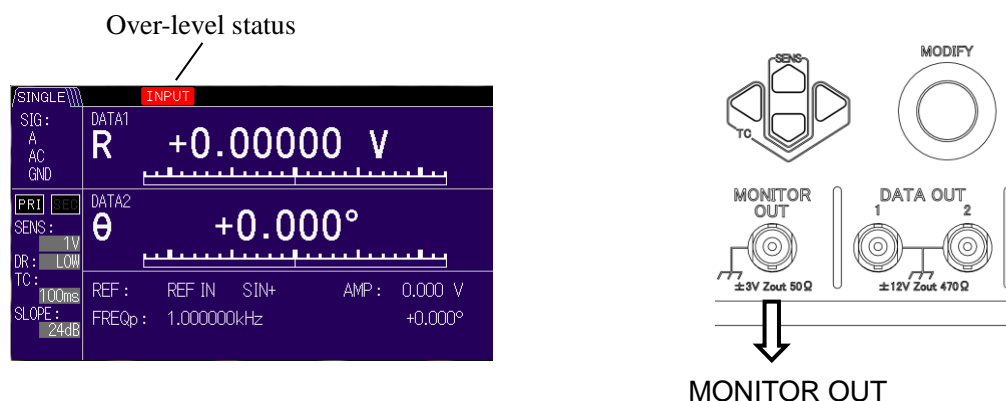

When more than one event occurs at the same time, their display priority status is according to the above table.

Do not connect an unnecessary signal to the LI5655 / LI5660 as the measurement may be affected. A signal exceeding the maximum input level of the input connector cannot be measured correctly. Check that the signal level is within the specification range using an oscilloscope, etc.

■ Monitor Output

The input signal of the PSD (primary PSD) can be checked with the MONITOR OUT connector.

If the measurement is not successful, check the monitor output using an oscilloscope, etc.

Gain from the input (A, A-B, C *¹, I, HF *¹) to the monitor output is equivalent to the AC gain.

For the AC gain, refer to the sensitivity setting and dynamic reserve setting, and the table in "9.2 Phase Detection Part c) Dynamic Reserve (DR)."

For input I, multiply it by a factor of the current-to-voltage conversion gain (10^6 V/A for 1 M and 10^8 V/A for 100 M).

For input C, multiply the AC gain by a factor of 1/10 for the attenuator.

Note that the phase is largely shifted by the anti-aliasing filter, so the monitor output phase significantly differs from the measured phase. Therefore, it is not suitable for checking the signal phase.

*1: Only the LI5660 is equipped with the C and HF connectors.

4.8 Phase Adjustment

In general, the phase reference (0°) of a lock-in amplifier can be shifted arbitrarily.

The basic usage is to adjust the phase of the reference signal to be applied to the PSD so Y output is equal to 0 ($\theta = 0$), and then measure the magnitude of the signal in the X output and changes in the phase in the Y output. Fluctuations due to random noise are $\sqrt{2}$ times larger in the R output than those in the X output. If the magnitude of the signal is constant, the Y output close to zero is almost in proportion to θ , and a minute phase change can be detected with high sensitivity by increasing the EXPAND scale factor (to x10 or x100).

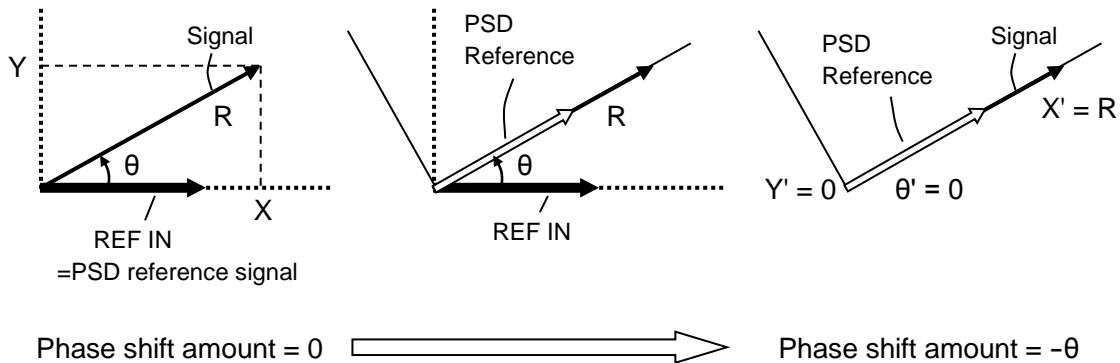

1) Phase Setting

First press the **PHASE** key to go to the following {Phase Adjustment Screen}.

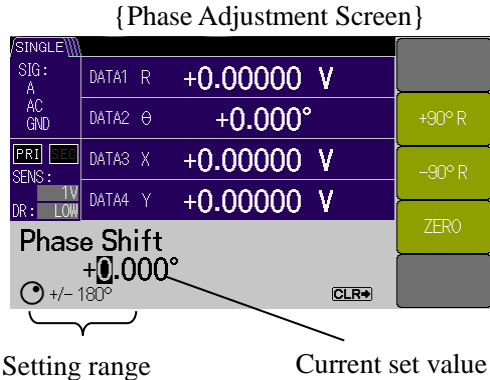

When you enter the operation screen, you can move through the digits using the left/right cursor keys and then set the numerical value using the MODIFY knob or up/down keys.

Press the [ZERO] soft key to set the phase shift amount for the reference signal to 0° .

Press the [+90°R] soft key to increase the phase shift amount for the reference signal by 90° .

Press the [-90°R] soft key to decrease the phase shift amount for the reference signal by 90° .

In the LI 5655 / LI 5660, when increasing (decreasing) the phase shift amount, the phase measurement value increases (decreases).

2) Auto Phase Adjustment

Press the [PHASE] soft key in the {Auto Setting Screen} (**AUTO** key) to set the phase shift amount for the reference signal just once so the Y output and the θ output are equal to zero.

If the auto phase adjustment is executed while the signal is not synchronized with the reference signal, an error occurs.

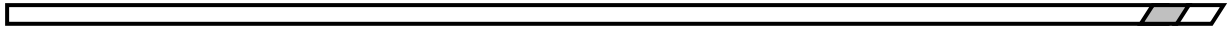

(Blank)

5. Advanced Operations

5.1 Measured Value Offset and Expansion.....	5-3
5.2 Line Frequency Noise Removal.....	5-5
5.3 Harmonic Measurement (Harmonic, Subharmonic, Fractional Harmonic).....	5-6
5.4 External 10 MHz Synchronization.....	5-7
5.5 Arithmetic Processing (Normalize and Ratio).....	5-8
5.5.1 Normalize (% , dB, etc.)	5-8
5.5.2 Ratio Measurement	5-10
5.6 Noise Density Measurement.....	5-12
5.6.1 Noise Density Measurement Operation.....	5-12
5.6.2 Noise Density Measurement Principle.....	5-14
5.7 PSD Input Offset Adjustment	5-15
5.8 DC Voltage Measurement (AUX IN)	5-17
5.9 DC Voltage Output (AUX OUT).....	5-19
5.10 Supplying Power to the Preamplifier.....	5-20
5.11 Setting Memory	5-21
5.12 Other Functions.....	5-23
5.12.1 Disable the Panel Operation (KEY LOCK)	5-23
5.12.2 Lamp Off (LAMP OFF)	5-23

This chapter describes the more advanced usage that is not covered in "4. Basic Operations. "
For details on dual frequency measurement, see "6. Dual Frequency Measurement"

5.1 Measured Value Offset and Expansion

An offset (OFFSET) can be applied to the measured value (X and Y).

A fixed crosstalk component included in the input signal can be canceled using the offset function.

Furthermore, offset adjustment can be performed to bring the measured value close to zero and expand (EXPAND) a small change and observe it.

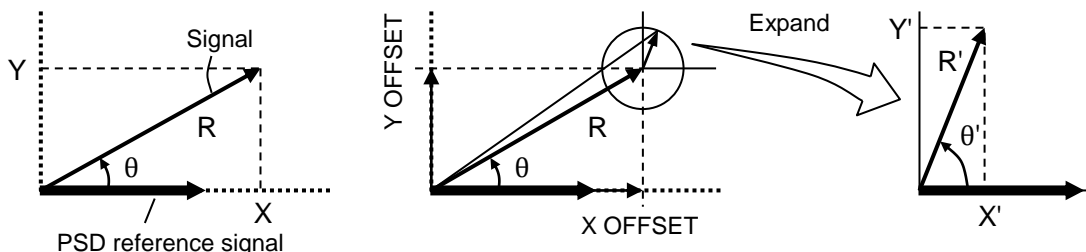

{Fine Measurement Screen}

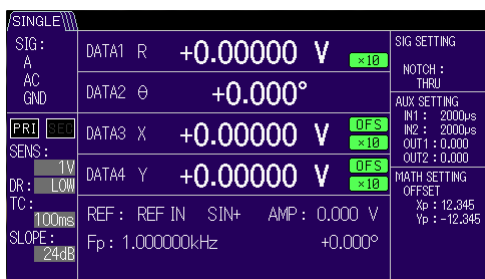

When the offset function is set to ON, the "OFS" icon is displayed in the measurement data field.

The offset adjustment value is displayed in MATH SETTING on the lower right corner of the fine measurement screen.

When the EXPAND function is set to ON, an icon showing a setting expansion value such as "x10" is displayed in the measurement data field.

First press the **DATA** key to go to the following {Output Signal Setting Screen}.

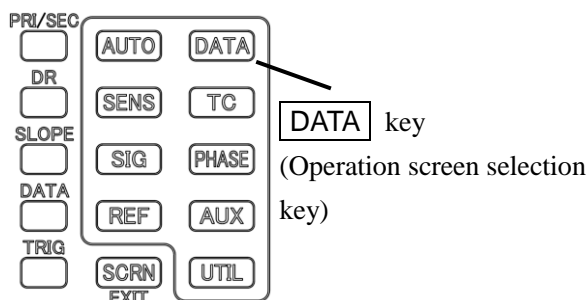

{Output Signal Setting Screen}

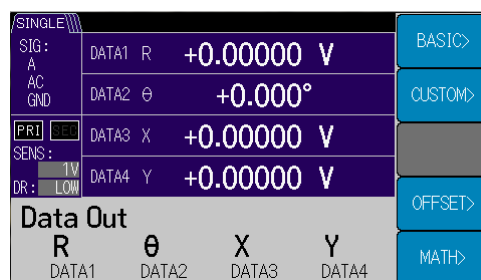

1) Offset

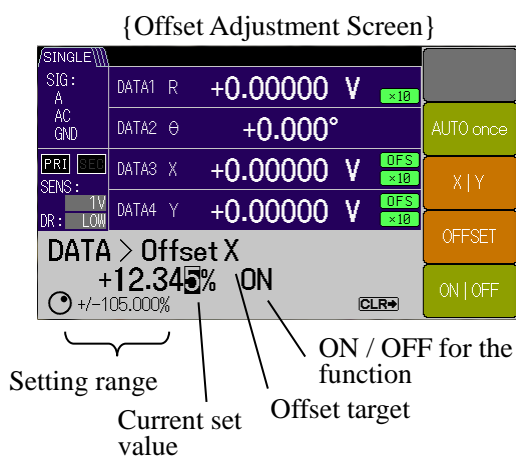

Next press the [OFFSET>] soft key to go to the {Offset Setting Screen}

Press the [OFFSET] soft key to move through the digits using the left/right cursor keys and then set the numerical value using the MODIFY knob or up/down keys.

Press the [X | Y] soft key to select the target (X or Y) to set the offset value.

Press the [ON | OFF] soft key to switch between ON and OFF for the offset adjustment. The offset value can be set individually for X and Y.

Press the [AUTO once] soft key to execute the auto offset adjustment only once to set the X and Y outputs to zero. When the auto setting is completed, the offset adjustment is set to ON.

2) Expansion

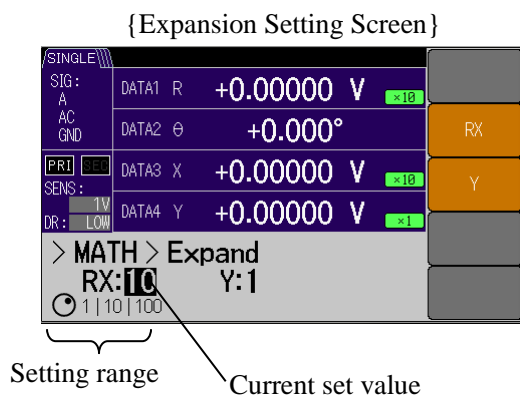

Next press the [MATH>] soft key to go to the {Math Selection Screen} Select "EXPAND" using the MODIFY knob or up/down keys to display the [EXPAND>] soft key.

Press the [EXPAND>] soft key to go to the {Expansion Setting Screen}.

Press the [RX] or [Y] soft key to set the expansion value {x1 | x10 | x100} using the MODIFY knob or up/down keys.

The expansion value for measurement data R and X is shared and the expansion value for Y is set individually.

The apparent sensitivity (signal full scale) can be expanded 0.1 times or 0.01 times using EXPAND.

■ Restrictions

Only detector outputs X, Y, and R can be expanded. If the X and Y offset adjustment is performed, the adjusted value is expanded.

Other parameters (phase, noise density, and AUX IN) cannot be expanded.

EXPAND is not executed while the normalize arithmetic processing or the ratio arithmetic processing is executed.

5.2 Line Frequency Noise Removal

A line filter (notch filter) to remove noise from the power supply included in the input signal is available. Line frequency noise removal has the following benefits.

- Dynamic reserve can be set to a smaller value to improve the measurement accuracy.
- Time constant and attenuation slope can be set to a smaller value to increase the response speed.

However, the transient response of the line filter may impact the measurement.

To set the power line filter, first press the **[SIG]** key to go to the {Input Signal Selection Screen}.

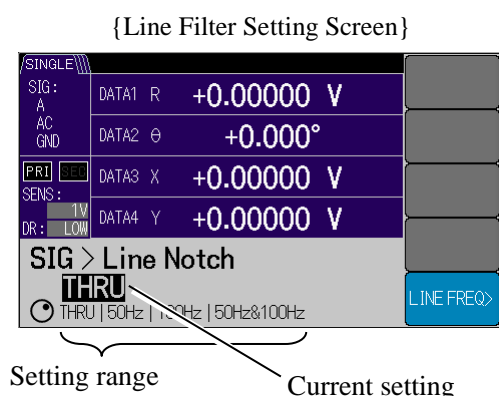

Next press the **[LINE NOTCH>]** soft key to go to the {Line Filter Setting Screen}.

The frequency of the line filter can be selected from {THRU | 50 Hz | 100 Hz | 50 Hz&100 Hz} using the MODIFY knob or up/down keys.

Press the **[LINE FREQ>]** soft key to go to the {Line Frequency Selection Screen}.

The line frequency (fundamental wave) can be selected from {50 Hz | 60 Hz} using the MODIFY knob or up/down keys.

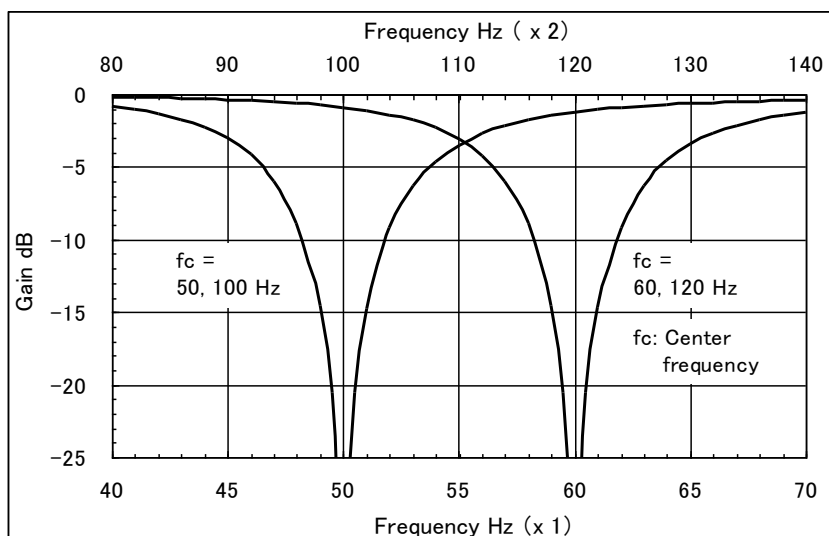

Figure 5-1 Line Filter Characteristics

50 Hz (60 Hz) and 100 Hz (120 Hz) can be cascade connected. The approximate characteristic of the measured value is corrected up to a gain of about -6 dB to prevent the attenuation. If the correction limit is exceeded, the correction amount is fixed to the limit value.

■ Restrictions (Only for the LI5660)

If the C or HF connector is selected, the line frequency filter cannot be set.

5.3 Harmonic Measurement (Harmonic, Subharmonic, Fractional Harmonic)

Fundamental wave (F), harmonic ($n \times F$), subharmonic (F / m), and fractional harmonic ($n \times F / m$) can be measured, where F is the frequency of the reference signal.

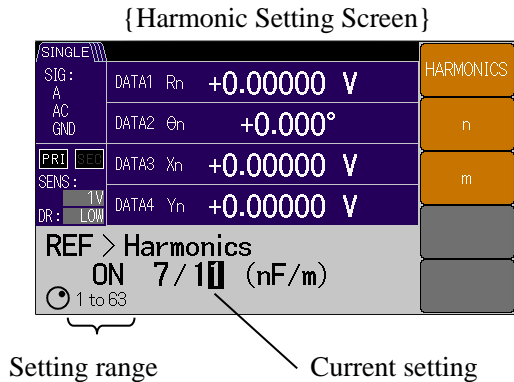

To set the harmonic measurement, first press the [REF] key to go to the {Reference Signal Setting Screen}.

Next press the [HMNC>] soft key to go to the {Harmonic Setting Screen}.

Press the [HARMONICS] soft key to select ON or OFF for the harmonic using the MODIFY knob or up/down keys.

Press the [n] soft key for the order of the harmonic and press the [m] soft key for the order of the subharmonic to move through the digits using the left/right cursor keys and then set the numerical value using the MODIFY knob or up/down keys.

The setting range is 1 to 63 for both n and m.

If the harmonic setting is set to ON, small letter "n" is added to the measurement parameter regardless of the harmonic order.

■ Restrictions

- If the measurement signal (SIGNAL) is selected for the reference signal source, the harmonic order is always 1 regardless of the harmonic setting of n or m.
- The frequency range of the harmonic that can be measured is limited to the synchronous frequency range of each input.

If the synchronous frequency range is exceeded, "OVER-FREQ" or "UNDER-FREQ" is displayed in the frequency display field.

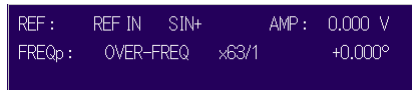

5.4 External 10 MHz Synchronization

The frequency reference source of the LI5655 / LI5660 can be synchronized with other devices (such as a signal generator).

If an external 10 MHz frequency reference source is connected to the 10MHz IN connector, the frequency synthesizer comprising the internal oscillator of the LI5655 / LI5660 is synchronized with the external 10 MHz.

Synchronizing operation allows synchronization to any frequency (can be configured) without having to use an external reference signal (REF IN). It makes it possible to perform measurements synchronized not only with the numerical value setting (INT OSC) but also with an external reference signal (REF IN) or measured signal (SIGNAL).

However, the phase does not match, so phase adjustment is required every time the frequency is changed. In general, once the signal (oscillation) stops, the phase is shifted, so phase adjustment is required again.

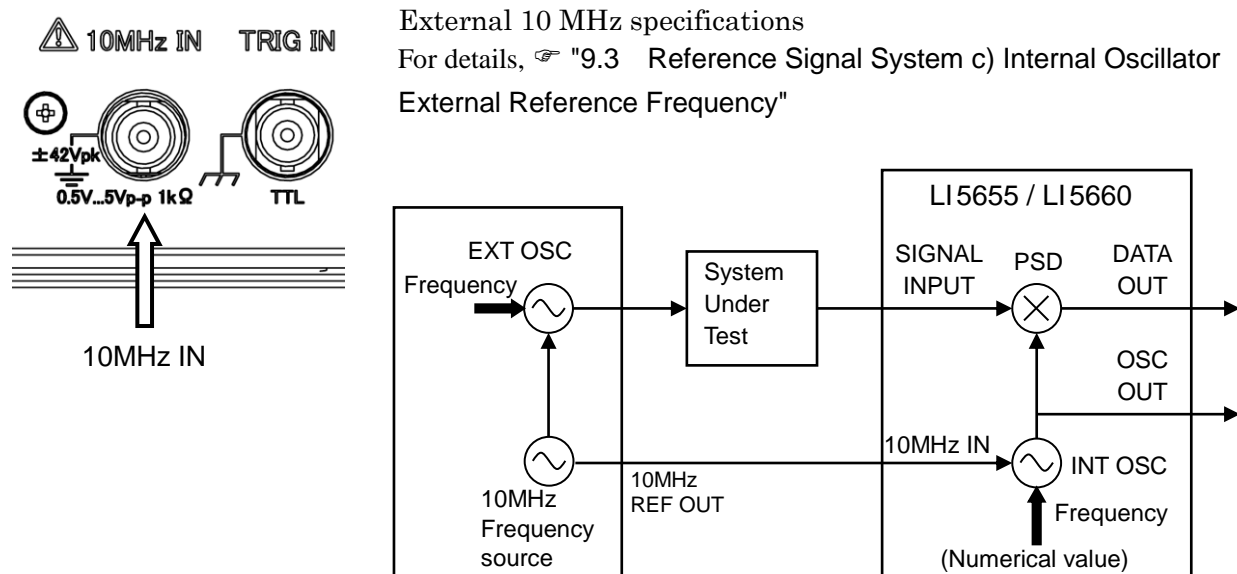
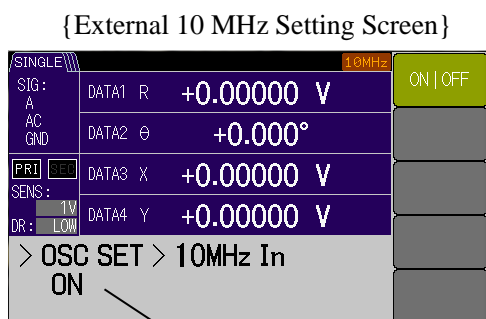

Figure 5-2 10 MHz Synchronous System Example

To set the external 10 MHz, first press the **[REF]** key to go to the {Reference Signal Setting Screen}.



Current setting

Next press the **[OSC SET>]** soft key to go to the {Internal Oscillation Setting Screen}.

Press the **[10MHz In>]** soft key to go to the {External 10 MHz Setting Screen}.

ON or OFF can be selected using the MODIFY knob or up/down keys.

If ON is set, the **10MHz** icon is displayed.

If a 10 MHz signal is input from 10MHz IN connector in this state, the color of the icon changes **10MHz** and synchronization is established.

5.5 Arithmetic Processing (Normalize and Ratio)

To perform an arithmetic processing (normalize or ratio), first press the **DATA** key to go to the {Output Signal Setting Screen}.

{Math Selection Screen}

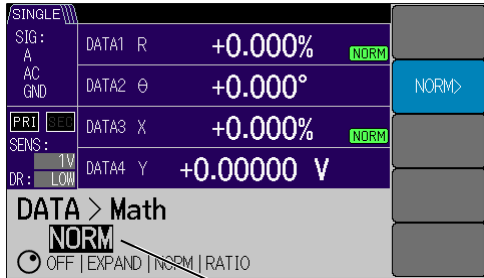

Settable parameters

Current setting

Next press the [MATH>] soft key to go to the {Math Selection Screen}.

Select arithmetic processing EXPAND, NORMALIZE, or RATIO using the MODIFY knob or up/down keys to display the soft key for each arithmetic processing.

Press the selected arithmetic processing soft key to set each arithmetic processing function.

5.5.1 Normalize (% , dB, etc.)

The ratio of measured values X and R to the standard value and sensitivity (signal full scale) can be output and displayed in % or dB.

1) Select the Operation Expression

{Normalize Setting Screen}

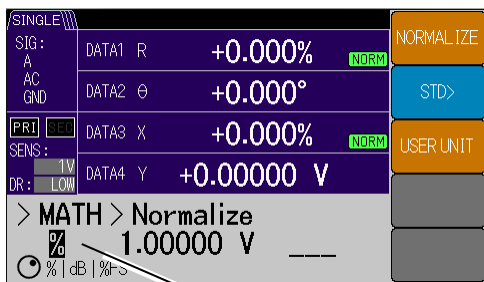

Settable parameters

Current setting

Press the [NORMALIZE] soft key to go to the {Normalize Setting Screen}.

The normalize arithmetic expression can be selected using the MODIFY knob or up/down keys.

- % : $(\text{measured value} \div \text{standard value}) \times 100$ [%]
Display range is $\pm 240\%$
- dB : $20 \times \log_{10} (|\text{measured value} \div \text{standard value}|)$ [dB]
Display range is ± 120 dB
- %FS : $(\text{measured value} \div \text{sensitivity setting}) \times 100$ [%FS]
Display range is $\pm 120\%$ of FS

2) Standard Value Setting

{Standard Value Setting Screen}

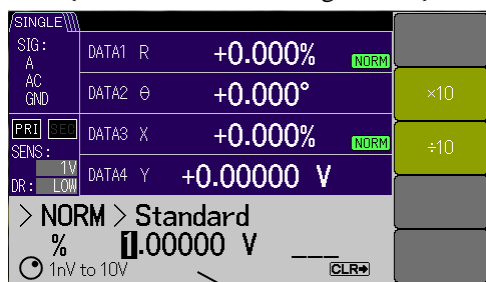

Settable parameters

Current set value

Press the [STD>] soft key to go to the {Standard Value Setting Screen}.

Move through the digits using the left/right cursor keys and then set the numerical value using the MODIFY knob or up/down keys.

The setting range is as follows.

- Voltage: 1 nV to 10 V (6-digit resolution)
- Current: 1 fA to 1 μ A (6-digit resolution)

The setting range is switched for the voltage measurement and current measurement.

3) User Unit Setting

{Normalize Setting Screen}

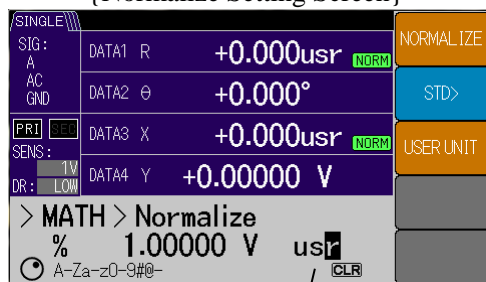

Settable characters

Current setting

Press the [USER UNIT] soft key to move through the digits using the left/right cursor keys and set the user unit string (1 to 3 characters) using the MODIFY knob or up/down keys.

The user unit string is displayed in place of the normal unit (% , etc). Alphanumeric characters (A-Z, a-z, 0-9) and some symbols (#, @, -), and blank " " can be used. If "_" is set, a blank " " is displayed.

Reset or press the **CLR** key to display " _ _ _ " in the setting screen and restore the normal unit.

■ Restrictions

The normalize arithmetic processing is performed for detector outputs X and R. The normalize arithmetic processing is not performed for other parameters (Y, θ , noise density, and AUX IN).

The normalize arithmetic processing cannot be executed while the ratio arithmetic processing or EXPAND arithmetic processing is executed.

5.5.2 Ratio Measurement

The LI5655 / LI5660 outputs and displays detector outputs X, Y, and R as a ratio to the signal (AUX IN 1) that is used as a reference to the magnitude.

If a sample inserted into the signal path is measured in a situation where the characteristics of the signal source and sensor fluctuate, measure the characteristics of the path that is used as a reference separately and obtain the ratio of them to correct the fluctuations in the common part to ensure that the measurement is correct. A dual beam method shown below measures the characteristics of the path that is used as a reference at a different frequency using two lock-in amplifiers to obtain a result where the characteristics of the light source and sensor are corrected.

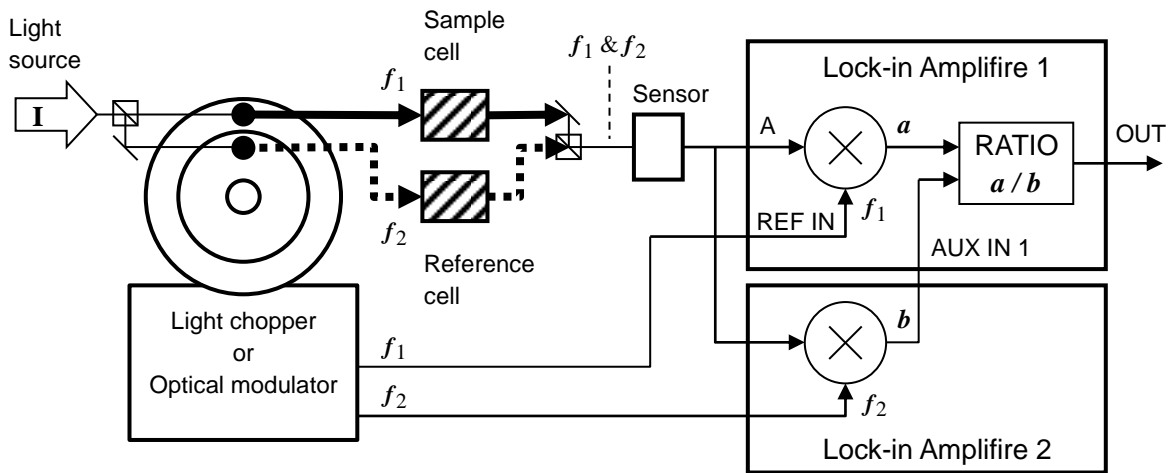
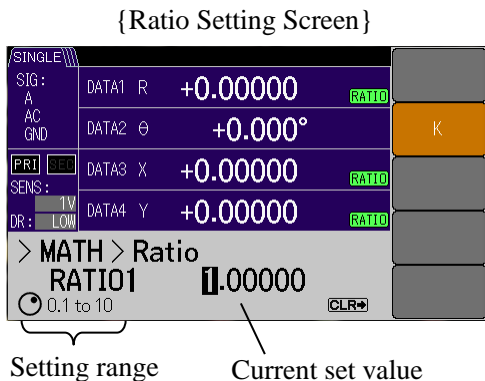

Figure 5-3 Ratio Measurement Application Example (Dual Beam Method)

The LI5655 / LI5660 can perform this ratio measurement by itself.

For details, see "6.9 Ratio Measurement (Dual Frequency Measurement)"

1) Ratio Setting



Press the [K] soft key in the {Ratio Setting Screen} to move through the digits using the left/right cursor keys and then set the K constant using the MODIFY knob or up/down keys.

$$\text{Ratio display value} = K \times (A \div B)$$

- K: Ratio scale factor setting value (Range 0.1 to 10, 6-digit resolution)
- A: Measurement display values (X, Y, R) ÷ sensitivity setting value
Value after the X and Y offset adjustment is performed.
- B: AUX IN 1 [V] ÷10 V

Ratio display range is ±2.4

If the ratio calculation result is +2.0, the analog output is +10 V.

2) Reference Value (AUX IN 1)

A reference signal is input into the AUX IN 1 connector on the rear panel.

The reference signal that is used as the denominator of the ratio calculation must be 1 V or more (the maximum allowable input voltage is ± 12 V) to reduce an error.

Although the frequency bandwidth of AUX IN is 5 kHz, the maximum update rate of B is about 10k samples/s, and a rapidly changing signal cannot be followed. So input a slowly changing signal of about 100 Hz or less.

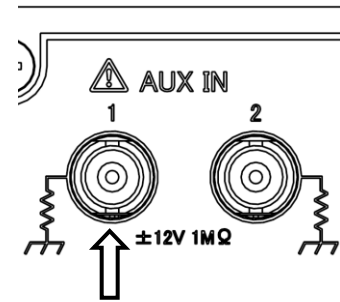

■ Restrictions

The ratio arithmetic processing is performed for detector outputs X, Y, and R. The ratio arithmetic processing is not performed for other parameters (θ , noise density, and AUX IN).

The ratio arithmetic processing cannot be executed while the normalize arithmetic processing or EXPAND arithmetic processing is executed.

5.6 Noise Density Measurement

5.6.1 Noise Density Measurement Operation

The following shows how to measure the noise density.

First press the **DATA** key to go to the {Output Signal Setting Screen}.

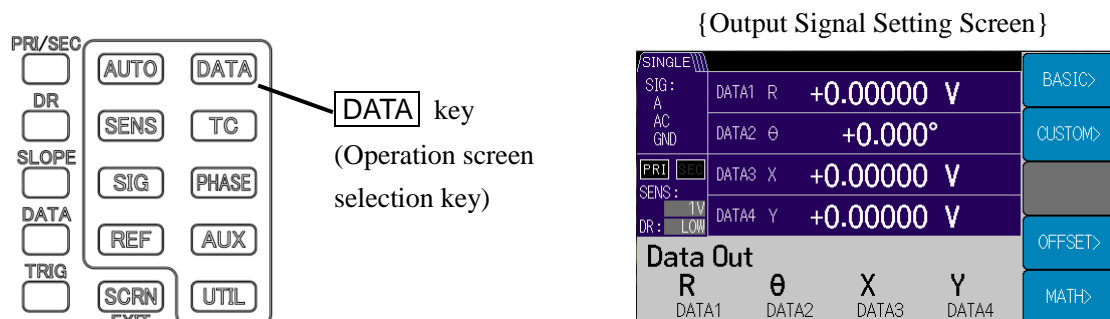

1) Display the Noise Density

{Basic Measurement Parameter Setting Screen}

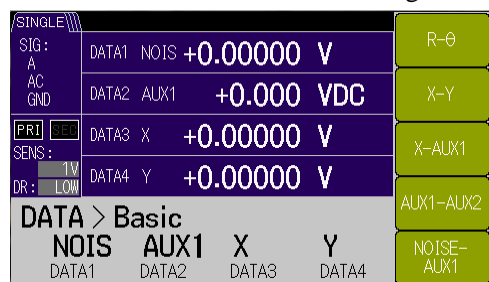

To display the noise density, press the [BASIC>] soft key and then the [NOISE-AUX1] soft key. NOISE and AUX IN 1 are set in DATA1 and DATA2, respectively. (Other settings are not changed.)

{Custom Measurement Parameter Setting Screen}

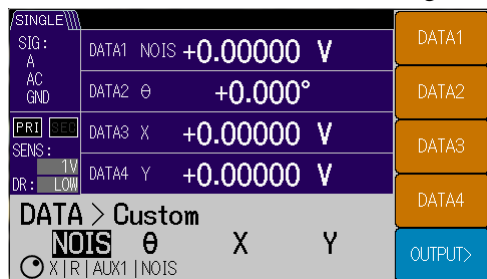

Press the [CUSTOM>] soft key and then the [DATA1] soft key to select "NOIS" using the MODIFY knob or up/down keys. NOISE is set in DATA1. (Other settings are not changed.)

2) Set the Time Constant

For the time constant (TC), set 1 ms or more, or a value of 10 times or more the signal cycle to be measured, and for the attenuation slope (SLOPE), set about 24 dB/oct, if there is no particular problem.

If the time constant and attenuation slope are too small, noise at distant frequencies or a ripple caused by phase sensitive detection may also be measured together. Therefore, the noise density may appear to be larger.

If the noise density decreases by increasing the time constant and attenuation slope, the time constant and attenuation slope are too small. If the time constant is increased, it takes longer to perform the measurement, so perform the manual adjustment as needed.

3) Set the Smoothing Factor

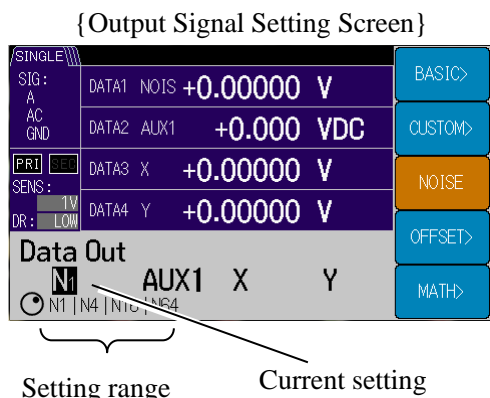

If you return to the {Output Signal Setting Screen}, the [NOISE] soft key is displayed.

Press the [NOISE] soft key to set the smoothing factor (1, 4, 16, 64) using the MODIFY knob or up/down keys.

Display example) N16: Smoothing factor = 16

If the smoothing factor is multiplied by 4, the fluctuations of the measured value decrease to about a half.

However, it takes a long time until the measured value is stabilized. By observing the variation of the following equation over time, read the median value, and use it as the measurement result.

$$200 \times \text{smoothing factor} \times \text{time constant [in seconds]}$$

4) Set the Sensitivity

The measurement full scale of the noise density is set in SENS (sensitivity).

Input connector		Measurement setting	Sensitivity range*2
A, A-B		Voltage noise density	20 nV to 1 V *3
C *1		Voltage noise density	1 mV to 10 V *3
I	1M [V/A]	Current noise density	1 pA to 1 μA *3
	100M [V/A]	Current noise density	100 fA to 10 nA *3
HF *1		Voltage noise density	1 mV to 1 V *3

*1: Only the LI5660 is equipped with the C and HF connectors.

*2: The sensitivity setting value of the noise density is the full scale and the sequence is 1-2-5. For details on the display range,

☞ "9.5 Measured Value Output and Display Section e) Numeric display"

*3: The units of the noise density (NOISE) are V_{rms} / \sqrt{Hz} (voltage) and A_{rms} / \sqrt{Hz} (current). Only V or A is displayed in the measurement screen. Add " $/ \sqrt{Hz}$ " to the unit that is displayed when you read it.

If there is the same frequency component as the measurement frequency, the noise density cannot be measured correctly. Furthermore, if a noise other than the measurement frequency is large, the dynamic reserve must be increased.

If "OVER" is displayed even if the measured value is sufficiently smaller than the full scale, increase the dynamic reserve or increase the sensitivity (signal full scale). However, if the dynamic reserve is increased, the input referred noise of this device increases.

There is a relationship for white noise as shown below.

$$\text{Noise density measured value} = \sqrt{\text{Input referred noise density of this device}^2 + \text{Input signal noise density}^2}$$

Noise density $4.5 \text{ nV}/\sqrt{\text{Hz}}$ (supplementary value) in the specifications is that when the dynamic reserve is LOW, 1 kHz and the sensitivity is 1 mV or less.

A noise smaller than that of the LI5655 / LI5660 cannot be measured. Use an external low-noise preamplifier (NF Corporation's SA series, etc.) to amplify the noise and measure it.

■ Supplementary Explanation

There are some cautions for the noise density measurement.

- The noise density measurement results vary depending on the selection of the sensitivity, dynamic reserve, time constant, and attenuation slope.
- If the time constant and attenuation slope are too small, other signals may be measured together.

When the sensitivity and time constant settings are determined, check the noise density of the LI 5655 / LI 5660 in a non-input-signal state. For the voltage measurement, short-circuit the input, and for the current measurement, open the input circuit (cover the input connector with a shield cap to protect against ambient noise) and measure the noise.

Then input the signal (noise) to be measured and check that the measured noise is sufficiently larger than the previously measured LI5655 / LI 5660 's own noise.

5.6.2 Noise Density Measurement Principle

If the RMS value (V_m) of a signal is measured by passing it through a filter with an equivalent noise bandwidth of B_N , the noise density (V_n) can be obtained by the following formula.

$$V_n = V_m / \sqrt{B_N}$$

A lock-in amplifier works as a band pass filter that uses the frequency (f_r) of the reference signal as the center frequency. A normal measurement measures only the center frequency, but a noise measurement measures the RMS values of all components of the band.

Actually a high pass filter is installed after a band limiting filter to remove the reference signal frequency components (DC components after phase sensitive detection) and obtain the RMS values. This prevents the influence of leak-in of the reference signal and the periodic fluctuations of the measured noise values.

The equivalent noise bandwidth (B_{bp}) for the noise measurement is a little narrower than that for measuring the magnitude of a signal. Therefore, the noise density is calculated using the equivalent noise bandwidth for the noise density.

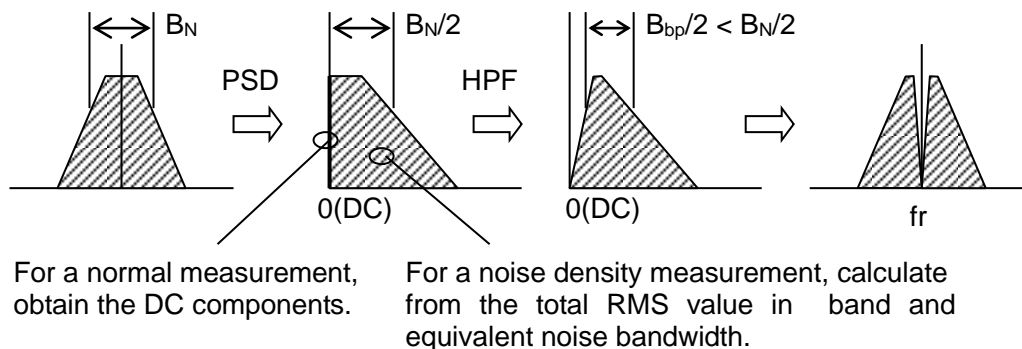
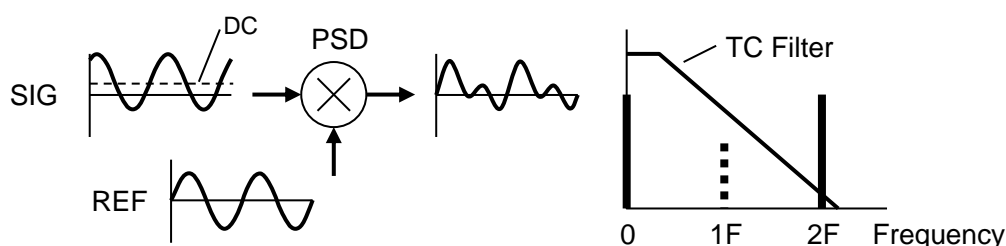

Figure 5-4 Noise Measurement and Bandwidth

5.7 PSD Input Offset Adjustment

The LI5655 / LI5660 has a function to cancel the DC offset of the PSD input.

If a DC component is included in the PSD input, a 1F ripple that is equal to the measurement frequency (F) occurs in the detection output. A large time constant is required to remove the 1F ripple. This slows the output response. If a high-speed response is needed at high frequencies, it is recommended to perform the PSD input offset adjustment. It is useful to use a synchronous filter at low frequency measurement.



If a large DC component is included in the input signal, set AC for the input coupling.

The PSD offset adjustment function of the LI5655 / LI5660 cancels a small DC offset that occurs in the LI5655 / LI5660.

1) PSD Input Offset Adjustment Operation

{PSD Adjustment Screen}



First press the **TC** key to go to the {Time Constant Setting Screen}.

Press the [PSD ADJ>] soft key to go to the {PSD Adjustment Screen}.

To perform the auto adjustment of the PSD input offset only once, press the [AUTO once>] soft key.

{PSD Adjustment Confirmation Screen}

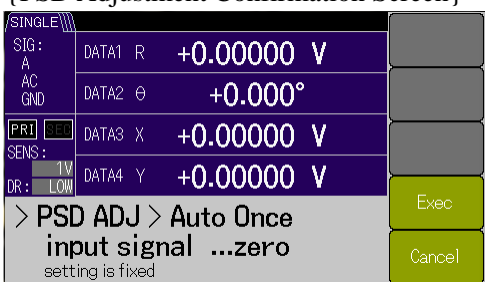

The {PSD Adjustment Confirmation Screen} is displayed. Keep the input connector in a non-signal state.

Press the [Exec] soft key to execute the auto adjustment.

Press the [Cancel] soft key to go back to the previous screen.

■ How to Set the Input Signal to Zero

Voltage measurement : Short-circuit the input connector using a short plug or 50 Ω terminator.

Current measurement : Cover the input connector with a shield cap or leave it open.

If the center contact is not shielded and is open, keep metals and dielectric materials where the potential fluctuates away from it to prevent noise coupling.

■ Preparations

The following preparations are needed to execute AUTO once.

- Determine the actual operating conditions.
If measurement conditions such as the signal input connector and sensitivity are changed, adjustment is required again.
- Set the input signal to zero.
- Perform the warm-up appropriately.
It can reduce drift after the adjustment.
Furthermore, keep the power voltage and ambient temperature as constant as possible.
If the continuous auto adjustment operation is used, those preparations are not needed.

2) PSD Input Offset Continuous Auto Adjustment Operation

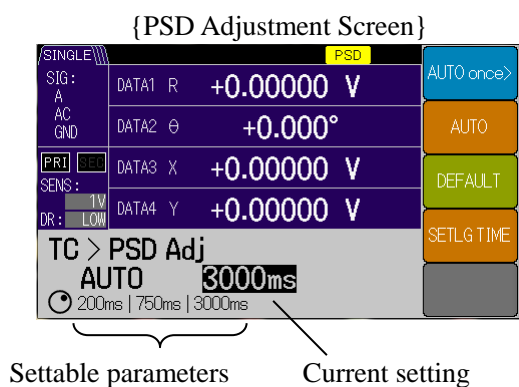

Press the [AUTO] soft key from the {PSD Adjustment Screen} to select AUTO or HOLD in the continuous auto setting using the MODIFY knob or up/down keys.

- AUTO: Performs the continuous auto adjustment operation.
- HOLD: Holds the last adjustment value.

The PSD icon is displayed during the execution of the continuous auto adjustment operation.

Press the [DEFAULT] soft key to reset the adjustment value to the factory default value and hold it.

Press the [SETLG TIME] soft key to set 200 ms, 750 ms, or 3000 ms for the settling time using the MODIFY knob or up/down keys.

The input offset (DC component) can be adjusted up to 25% of full-scale sensitivity.
The settling time refers to the time it takes for the input offset to settle to approximately 2% if it is 100%.

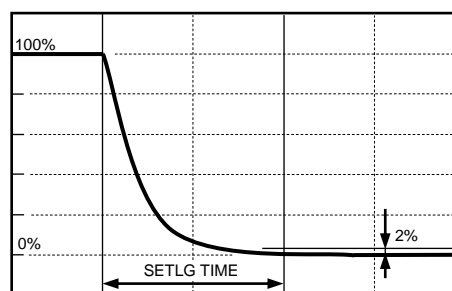

Response characteristics (for the continuous auto adjustment operation)

For the continuous auto adjustment operation, the signal gain decreases at low frequencies so a measurement error increases.
Use approximately 320 Hz or more if 200 ms is set, 85 Hz or more if 750 ms is set, and 21 Hz or more if 3000 ms is set.
If the adjustment range is exceeded, the maximum adjustment value is set. At this point, an error message is not displayed.

5.8 DC Voltage Measurement (AUX IN)

The LI5655 / LI5660 is equipped with two connectors for DC voltage measurement on the rear panel.

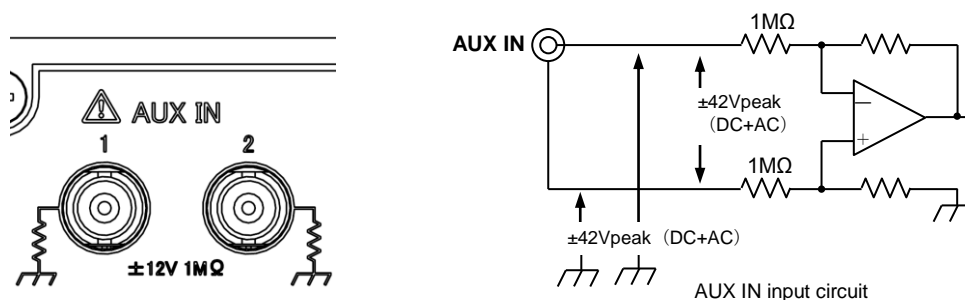

The measurement voltage range is ± 12 V and the display resolution is 0.001 V.

The sampling rate is 125 k samples/s, and the frequency bandwidth is approximately 5 kHz (-3 dB).

The maximum input voltage (non-destructive) is ± 42 V between the center contact of the BNC connector and the outer contact, and ± 42 V_{peak} (DC+AC) between the center contact and the enclosure, as well as between the outer contact and the enclosure.

Ensure that the potential of the signal ground (outer contact) is the same as the enclosure potential (ground potential) as much as possible.

If the potential of the signal ground (outer contact) exceeds the range of ± 1 V from the enclosure potential or fluctuates at a frequency exceeding 1 kHz, an additional error may occur.

If measurements fluctuate significantly, increase the smoothing time constant (narrow the bandwidth) to reduce the fluctuations. However, this slows the response.

If the input voltage changes in a stepwise manner, the time it takes for the measured value to settle to 99.9% of the final value is approximately 7 times the time constant.

The following shows how to measure the DC voltage.

First press the **DATA** key to go to the {Output Signal Setting Screen}.

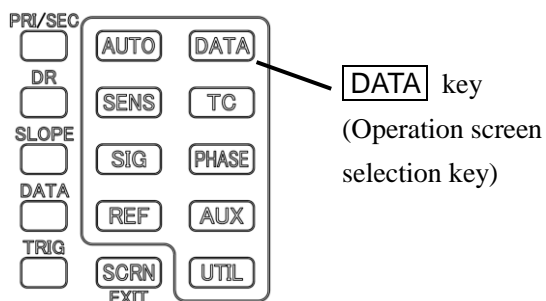

{Output Signal Setting Screen}

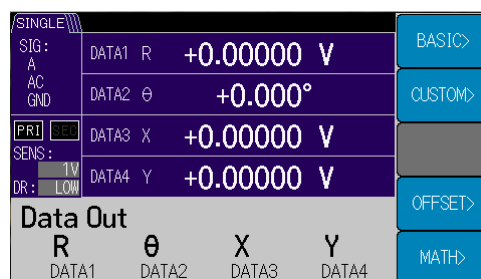

1) Display AUX

{Basic Measurement Parameter Setting Screen}

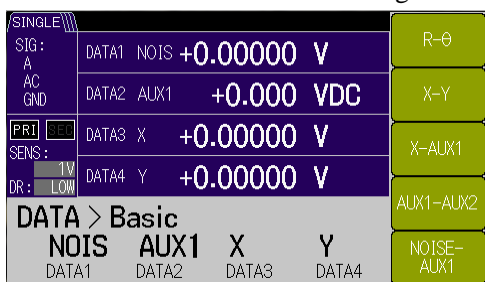

Press the [BASIC>] soft key and then the [AUX1-AUX2] soft key.

AUX1 and AUX2 are set in DATA1 and DATA2, respectively. (Other settings are not changed.)

{Custom Measurement Parameter Setting Screen}

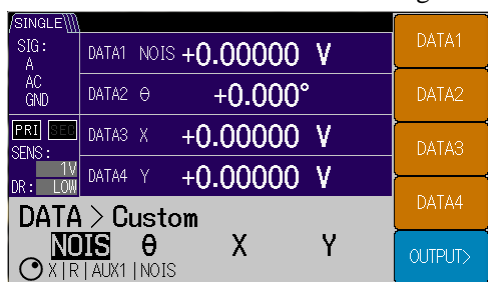

Press the [CUSTOM>] soft key and then the [DATA1] soft key to select "AUX1" using the MODIFY knob or up/down keys.

Press the [DATA2] soft key to select "AUX1" or "AUX2" using the MODIFY knob or up/down keys. (Other settings are not changed.)

2) Set the Smoothing Time Constant

First press the [AUX] key to go to the {Auxiliary I/O Setting Screen}.

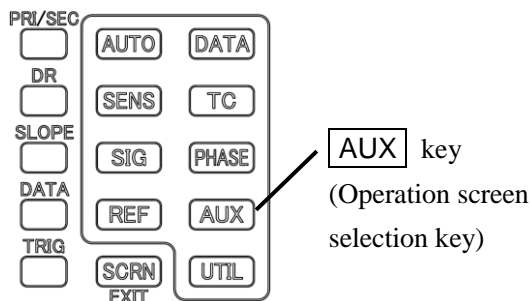

{Auxiliary I/O Setting Screen}

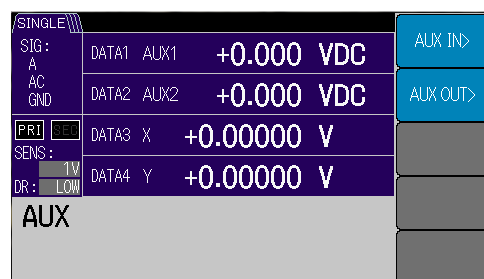

{Auxiliary Input Setting Screen}



Settable parameters Current set value

Press the [AUX IN>] soft key from the {Auxiliary I/O Setting Screen} to go to the {Auxiliary Input Setting Screen}.

Then, to set the smoothing time constant for AUX IN1, press the [IN1] soft key to select the time constant using the MODIFY knob or up/down keys.

To set the same for AUX IN2, press the [IN2] soft key to perform the same operation.

5.9 DC Voltage Output (AUX OUT)

The LI5655 / LI5660 is equipped with two DC voltage output connectors on the rear panel. The output impedance is approximately 1 kΩ.

The signal ground of the DC output voltage connector is connected to the enclosure.

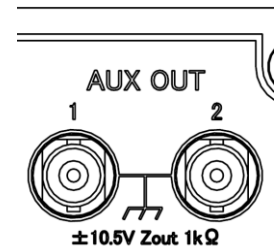

First press the **AUX** key to go to the {Auxiliary I/O Setting Screen}.

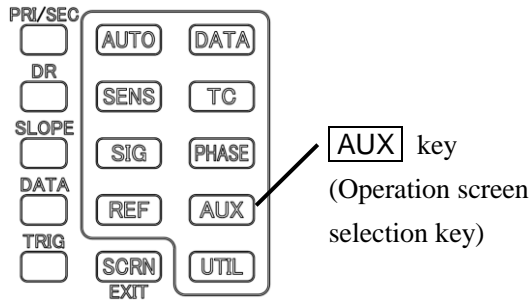

{Auxiliary I/O Setting Screen}

/SINGLE				
SIG: A	DATA1	AUX1	+0.000 VDC	AUX IND
AC GND	DATA2	AUX2	+0.000 VDC	AUX OUT>
PRI: []	DATA3	X	+0.00000 V	
SENS: []	DATA4	Y	+0.00000 V	
DR: []				
AUX				

{Auxiliary Output Setting Screen}

/SINGLE				
SIG: A	DATA1	R	+0.00000 V	OUT1
AC GND	DATA2	θ	+0.000°	OUT2
PRI: []	DATA3	X	+0.00000 V	
SENS: []	DATA4	Y	+0.00000 V	
DR: []				
AUX > Aux Out1				
+0.000VDC				
±/-10.5VDC CLR				

Setting range Current set value

Press the [AUX OUT>] soft key from the {Auxiliary I/O Setting Screen} to go to the {Auxiliary Output Setting Screen}.

To set the output voltage value for AUX OUT1, press the [OUT1] soft key to move through the digits using the left/right cursor keys and then set the numerical value using the MODIFY knob or up/down keys.

To set the same for AUX OUT2, press the [OUT2] soft key to perform the same operation.

The output voltage range is ±10.500V and the resolution is 0.001 V.

CAUTION

Do not apply a voltage to the output connector from outside. The internal circuit may be damaged.

There is an output current limit. Ensure that the load impedance is 1.1 kΩ or more.

5.10 Supplying Power to the Preamplifier

When you use a separately sold NF Corporation's preamplifier (LOW NOISE AMPLIFIER SA series), it is recommended to use a recommended power supply (LOW NOISE DC POWER SUPPLY LP series, etc).

In general, a preamplifier and its power supply are more immune to external noise if they are installed near the signal source. Lay the signal ground wires (reference potential) of the signal source and amplifier as close to each other as possible to reduce the influence of common-mode noise, and amplify a signal and then transmit it to make it more immune to the influence of noise.

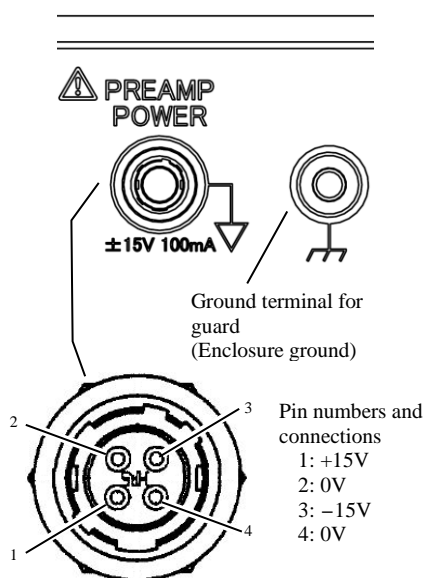

Hirose HR10-7R-4S (73)

Applicable Preamplifiers

The following preamplifiers were verified to work with the LI5655 / LI5660.

- WIDEBAND CURRENT AMPLIFIER SA-600 series
- LOW NOISE AMPLIFIER SA-400 series

This information is valid at the time when this instruction manual was prepared. For the latest information, consult with NF Corporation or one of our representatives.

⚠ CAUTION

Do not connect a device whose compatibility NF Corporation did not certify to the PREAMP POWER connector. Otherwise, the connected device or the LI5655 / LI5660 may be damaged or injury may result.

5.11 Setting Memory

The LI5655 / LI5660 is equipped with 9 sets of setting memory. Frequently used settings can be stored in the setting memory and recalled when they are needed.

To save settings to the setting memory or recall them, first press the **UTIL** key to go to the {Utility Screen}.

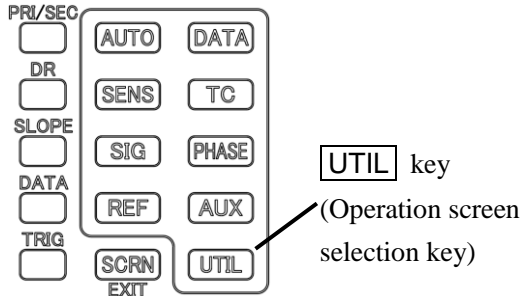

{Utility Screen}

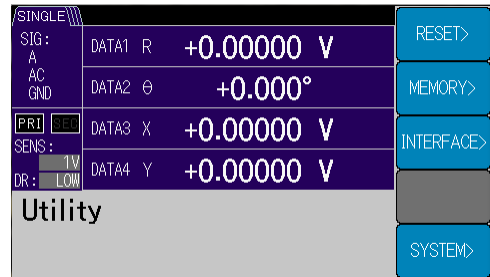

1) Select the Setting Memory

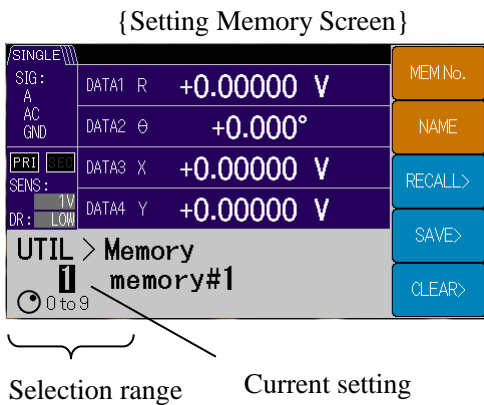

Press the [MEMORY>] soft key from the {Utility Screen} to go to the {Setting Memory Screen}.

To select the setting memory, press the [MEM No.] soft key to select a number from 0 to 9 using the MODIFY knob or up/down keys.

Setting memory "0" stores the setting values (resume memory) just before the power is turned off or shut off. When the power is turned on, setting memory "0" is recalled.

2) Change the Setting Memory Name

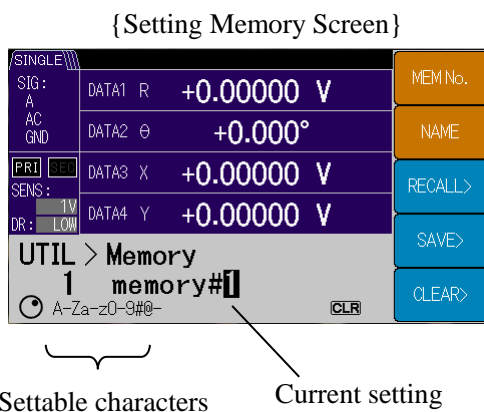

To change the setting memory name, press the [NAME] soft key to move through the positions using the left/right cursor keys and then set the memory name (1 to 8 characters) using the MODIFY knob or up/down keys.

Alphanumeric characters (A-Z, a-z, and 0-9) and some symbols (#, @, -) can be used.

A change of name is applied immediately so there is no check work.

3) Recall the Setting Memory

{Setting Memory Recall Screen}

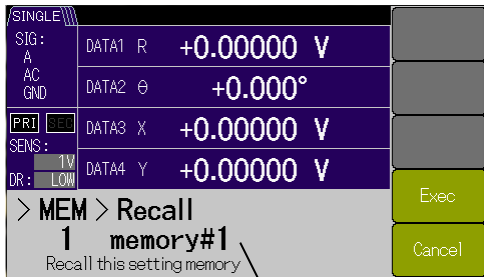

Selected setting memory

To recall the setting memory selected in the {Setting Memory Screen}, press the [RECALL>] soft key. The confirmation screen is displayed. To execute the recall, press the [Exec] soft key, and to cancel it, press the [Cancel] soft key.

The setting memory numbers to be recalled are 0 to 9.

4) Save to the Setting Memory

{Setting Memory Save Screen}

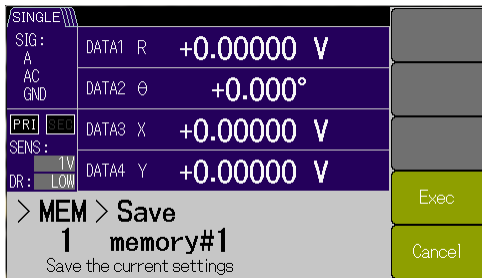

To save the setting to the setting memory selected in the {Setting Memory Screen}, press the [SAVE>] soft key. The confirmation screen is displayed. To execute it, press the [Exec] soft key, and to cancel it, press the [Cancel] soft key.

The setting memory numbers to which the setting can be saved are 1 to 9.

5) Clear the Setting Memory

{Setting Memory Clear Screen}

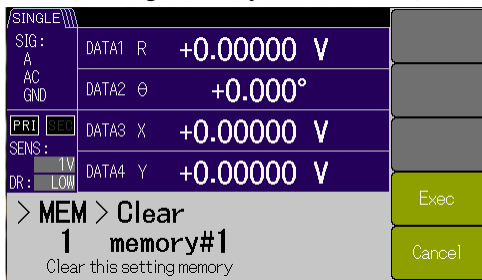

To clear the setting memory selected in the {Setting Memory Screen}, press the [CLEAR>] soft key. The confirmation screen is displayed. To execute it, press the [Exec] soft key, and to cancel it, press the [Cancel] soft key.

The setting memory numbers that can be cleared are 1 to 9.

5.12 Other Functions

5.12.1 Disable the Panel Operation (KEY LOCK)

If you wish to disable the panel key and knob operations to prevent misoperation, hold down the **CLR** key for at least 2 seconds in the measurement screen to turn on the KEY LOCK lamp. Once the lamp turns on, release the key immediately.

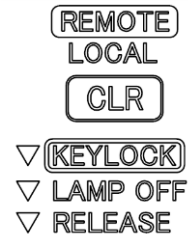

The front panel keys and knob cannot be operated while the KEY LOCK lamp is ON. However, they can be used for the lamp-off operation and key lock and lamp-off cancellation.

5.12.2 Lamp Off (LAMP OFF)

If you wish to avoid interference from ambient light in optical measurement, hold down the **CLR** key for at least 2 seconds to turn on the KEY LOCK lamp and continue to hold it down for at least another 2 seconds to turn off all lamps and the display backlight. When they turn off, release the key. Both the key lock and lamp-off are set to ON.

The lamp of the LAN connector on the rear panel also turns off in conjunction with the lamp-off.

■ Key Lock and Lamp-off Cancellation (RELEASE)

Hold down the **CLR** key for at least 2 seconds in the lamp-off state to cancel both the key lock and lamp-off states. When the power is turned off and then on, both the functions are canceled.

■ LOCAL Key (Remote Control)

Press the **CLR** key at remote mode (panel operation disable and REMOTE lamp ON) to restore the local mode (panel operation enabled).

For details, see "LI5655 / LI5660 Instruction Manual (Remote Control)"

"2. Switching between remote / local states"

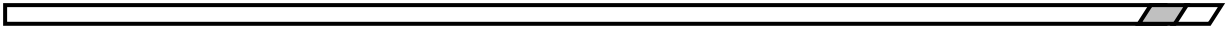

(Blank)

6. Dual Frequency Measurement

6.1 Overview of the Dual Frequency Measurement	6-3
6.1.1 SINGLE (Single Frequency Measurement)	6-3
6.1.2 DUAL1 (Fractional Harmonic Mode)	6-4
6.1.3 DUAL2 (Independent Frequency Mode).....	6-5
6.1.4 CASCADE (Cascade Mode).....	6-6
6.2 Detection Mode Setting.....	6-7
6.3 Measurement Parameter Setting, Output, and Display (Dual frequency Measurement)	6-8
6.4 Frequency Setting of the Internal Oscillator (Dual Frequency Measurement)	6-10
6.5 Time Constant Filter Setting (Dual Frequency Measurement)	6-11
6.6 Sensitivity Setting (Dual Frequency Measurement)	6-12
6.7 Phase Adjustment (Dual Frequency Measurement).....	6-12
6.8 Measured Value Offset and Expansion (Dual Frequency Measurement)	6-13
6.9 Ratio Measurement (Dual Frequency Measurement)	6-14

This chapter describes the dual frequency measurement (detection modes DUAL1, DUAL2, and CASCADE).

The same operations as those of the single frequency measurement (detection mode SINGLE) are omitted. Before reading this chapter, read the description of the operations for the single frequency measurement (Chapters 4 and 5).

6.1 Overview of the Dual Frequency Measurement

The LI5655 / LI5660 is equipped with two dual-phase primary and secondary PSD (Phase-Sensitive-Detector). This enables two frequency components included in a single input signal to be measured simultaneously. The LI5655 / LI5660 has the following four detection modes, including the normal single frequency measurement.

*1: C and HF connectors in the following sections are present only on the LI5660.

6.1.1 SINGLE (Single Frequency Measurement)

Performs a normal single frequency measurement.

A signal component of a fundamental frequency (F) or fractional harmonic frequency ($n \times F / m$) is measured, where F is the frequency of the reference signal. The secondary PSD is not used.

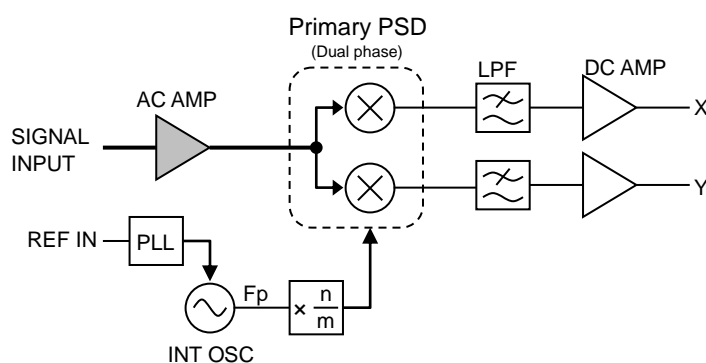

Setting Frequency Range

Signal input	Primary PSD	
	Reference signal source	Primary frequency (Fp) range
A A-B C *1 I	REF IN SIN POS TTL POS TTL NEG INT OSC SIGNAL	0.3 Hz to 3.2 MHz
HF *1	REF IN TTL POS TTL NEG INT OSC	8 kHz to 11.5 MHz

6.1.2 DUAL1 (Fractional Harmonic Mode)

The primary and secondary PSD are connected in parallel.

The primary PSD can measure the signal component of the fractional harmonic frequency ($n \times F / m$) and the secondary PSD can measure the signal component of the harmonic frequency ($n \times F$) simultaneously.

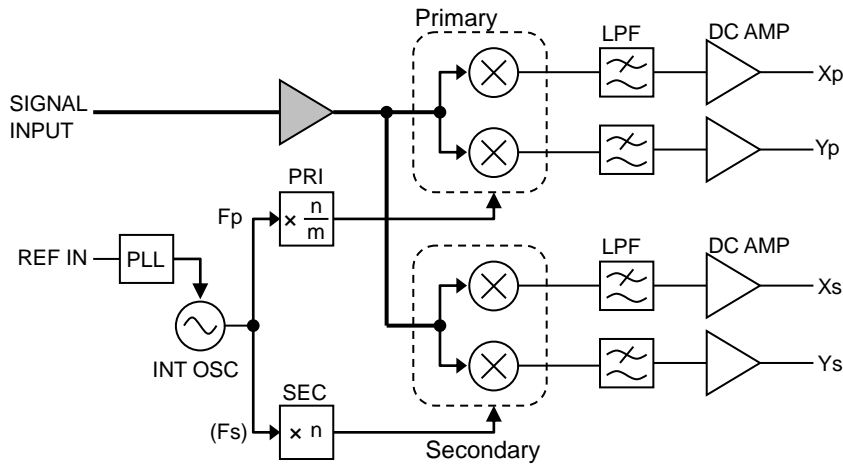

Setting Frequency Range

Signal input	Primary PSD		Secondary PSD	
	Reference signal source	Primary frequency (Fp) range	Reference signal source	Secondary frequency (Fs) range
A A-B C *1 I	REF IN SIN POS TTL POS TTL NEG INT OSC SIGNAL	0.3 Hz to 3.2 MHz	Same with the primary PSD	
HF *1	REF IN TTL POS TTL NEG INT OSC	8 kHz to 11.5 MHz		

■ Restrictions

The frequency range of the harmonic that can be measured is limited to the synchronous frequency range of each input.

If the measurement signal (SIGNAL) is selected for the reference signal source, the PRI side is always 1/1-fold and the SEC side is 1-fold regardless of the harmonic setting n or m.

■ Supplementary Explanation

Harmonic setting "n" is not the same in the primary and secondary PSD.

"n" and "m" of fractional harmonic ($n \times F / m$) of the primary PSD are "PRI n" and "PRI m," respectively.

"n" of harmonic ($n \times F$) of the secondary PSD is "SEC n."

They can be set individually.

6.1.3 DUAL2 (Independent Frequency Mode)

The primary and secondary PSDs are connected in parallel.

The primary PSD can measure the signal component of the primary frequency (F_p) and the secondary PSD can measure the signal component of the secondary frequency (F_s) simultaneously.

REF IN, INT OSC, and SIGNAL can be selected for the reference signal to the primary PSD. However, for the reference signal to the secondary PSD, only INT OSC can be selected.

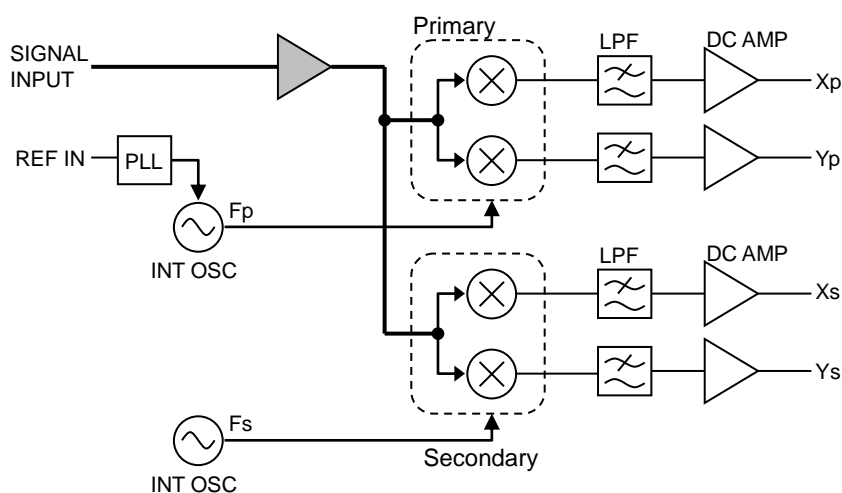

Setting Frequency Range

Signal input	Primary detector		Secondary detector	
	Reference signal source	Primary frequency (F_p) range	Reference signal source	Secondary frequency (F_s) range
A A-B C ^{*1} I	REF IN SIN POS TTL POS TTL NEG INT OSC SIGNAL	0.3 Hz to 3.2 MHz	INT OSC	0.3 Hz to 3.2 MHz
HF ^{*1}	REF IN TTL POS TTL NEG INT OSC	8 kHz to 11.5 MHz	INT OSC	8 kHz to 11.5 MHz

■ Supplementary Explanation

An external reference signal (synchronous frequency) input from REF IN is not synchronized with the secondary frequency.

If the reference signal source that inputs into REF IN is synchronized with the 10 MHz reference frequency, synchronization can be performed using the external 10 MHz synchronization function.

6.1.4 CASCADE (Cascade Mode)

The primary and secondary PSDs are cascade-connected.

Detects a primary frequency signal using the primary PSD and detects that result with a secondary frequency using the secondary PSD.

In CASCADE, The external reference signal (REF IN) is not connected to the primary PSD but to the secondary PSD. Therefore, although REF IN and INT OSC can be selected for the reference signal to the secondary PSD, only INT OSC can be selected for the reference signal to the primary PSD.

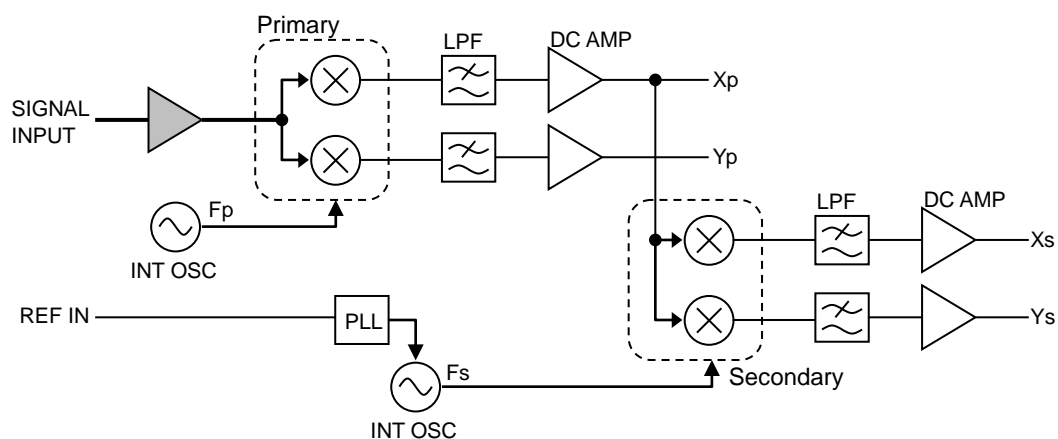

Setting Frequency Range

Signal input	Primary detector		Secondary detector	
	Reference signal source	Primary frequency (Fp) range	Reference signal source	Secondary frequency (Fs) range
A A-B C ^{*1} I	INT OSC	0.3 Hz to 3.2 MHz	REF IN SIN POS TTL POS TTL NEG INT OSC	0.3 Hz to 3.2 MHz
HF ^{*1}	INT OSC	8 kHz to 11.5 MHz	REF IN SIN POS TTL POS TTL NEG INT OSC	0.3 Hz to 3.2 MHz

■ Restrictions

There are some restrictions on the cascade mode.

- The measurement signal (SIGNAL) cannot be selected for the reference signal source.
- If the HF^{*1} input is selected, the frequency range of the primary frequency (Fp) is limited to 8 kHz to 11.5 MHz, and the frequency range of the secondary frequency (Fs) is limited to 0.3 Hz to 3.2 MHz.

6.2 Detection Mode Setting

To select the detection mode, first press the **REF** key to go to the {Reference Signal Setting Screen}.

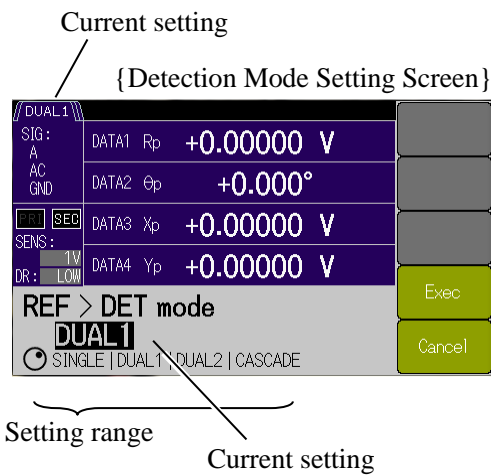
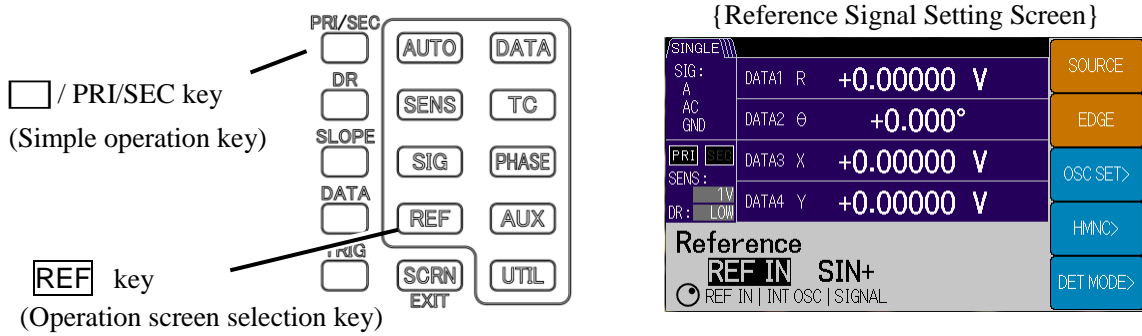

Press the [DET MODE>] soft key from the {Reference Signal Setting Screen} to go to the {Detection Mode Setting Screen}.

Select the detection mode using the MODIFY knob or up/down keys.

Press the [Exec] soft key to execute the setting.

Press the [Cancel] soft key to go back to the previous screen.

If DUAL1, DUAL2, or CASCADE is selected for the detection mode, the **□** / PRI/SEC key is enabled in the measurement screen.

Press the **□** / PRI/SEC key from the measurement screen to switch between the **PRI** (primary PSD) icon and **SEC** (secondary PSD) icon on the screen. The sensitivity (SENSE), time constant (TC), and attenuation slope (SLOPE) of the PSD that is lit can be set.

However, the dynamic reserve setting is shared by the primary and secondary PSDs.

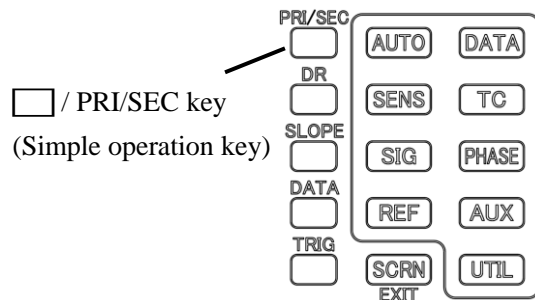

6.3 Measurement Parameter Setting, Output, and Display (Dual frequency Measurement)

The number of measurement parameter options that can be output and displayed is larger in the dual frequency measurement than that in the single frequency measurement.

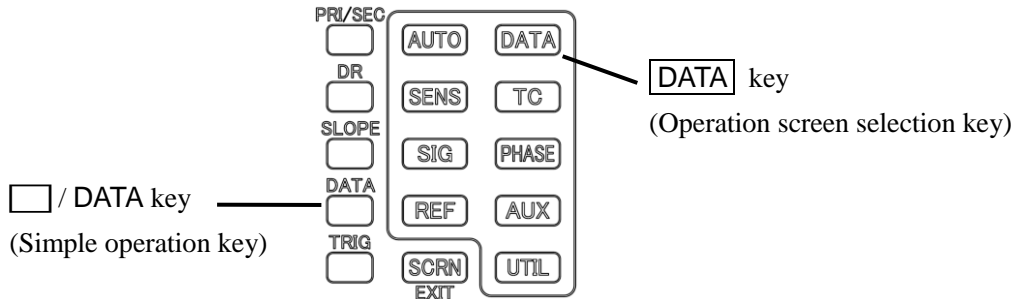

1) Operation in the Measurement Screen

Measurement parameters are switched as follows using the □ / DATA key only for DATA1 and DATA2.

DATA1 - DATA2: (before change) → $R_p - \theta_p \rightarrow X_p - Y_p \rightarrow X_s - Y_s \rightarrow X_p - X_s \rightarrow R_p - \theta_p$

2) Operation in the Operation Screen

First press the DATA key to go to the {Output Signal Selection Screen}.

{Output Signal Selection Screen}

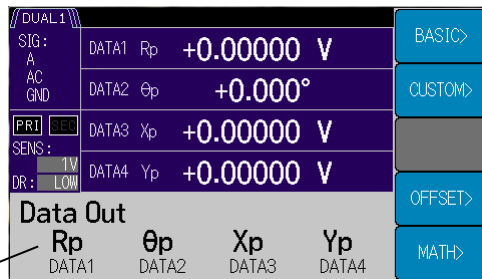

Current DATA1, DATA2, DATA3, DATA4 output and display parameters (for DUAL1)

{Basic Measurement Parameter Setting Screen}

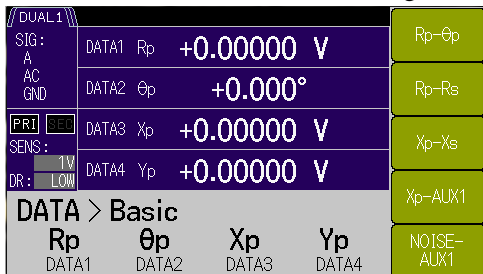

Next press the [BASIC>] soft key to display the basic combination of soft keys.

The soft key display content is specified in DATA1 and DATA2.

Press the [Xp-Yp] soft key to set Xp in DATA1 and Yp in DATA2.

Furthermore, DATA3 and DATA4 are not changed.

{ Custom Measurement Parameter Setting Screen }

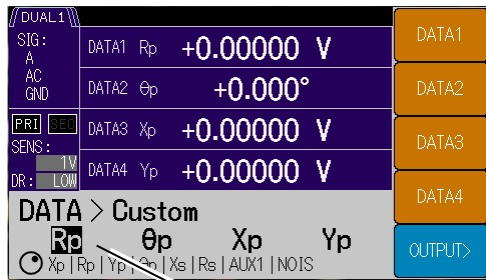

Press the [CUSTOM>] soft key to arbitrary set parameters in DATA1 to DATA4.

To change the parameter in DATA1, press the [DATA1] soft key and then select the measurement parameter using the MODIFY knob or up/down keys.

Setting range Current setting

The measurement parameters that can be set are as follows.

Output / display	Detection mode	
	SINGLE	DUAL1 DUAL2, CASCADE
DATA1	X, R, AUX IN 1, NOISE	X _p , R _p , Y _p , θ _p , X _s , R _s , AUX IN 1, NOISE
DATA2	Y, θ, AUX IN 1, AUX IN 2	Y _p , θ _p , X _s , R _s , Y _s , θ _s , AUX IN 1, AUX IN 2
DATA3	X, R	X _p , R _p , Y _p , θ _p , X _s , R _s
DATA4	Y, θ	Y _p , θ _p , X _s , R _s , Y _s , θ _s
Remark: X, Y, R, θ suffix	n: Harmonic order (n is added to the end when the harmonic is set. Example: Xn)	p: Primary PSD s: Secondary PSD n: Harmonic order (n is added to the end when the harmonic is set. Example: Xpn)

■ Restrictions

- Measurement parameter settings are retained for each of detection modes SINGLE, DUAL1, and DUAL2 (CASCADE shares the settings with DUAL2).
- Only the primary PSD can measure the noise density.

6.4 Frequency Setting of the Internal Oscillator (Dual Frequency Measurement)

In detection modes DUAL2 and CASCADE, the frequency of the internal oscillator can be set individually for the primary frequency and secondary frequency.

Furthermore, the frequency to output to the oscillator output (OSC OUT) can be selected for the primary frequency and secondary frequency.

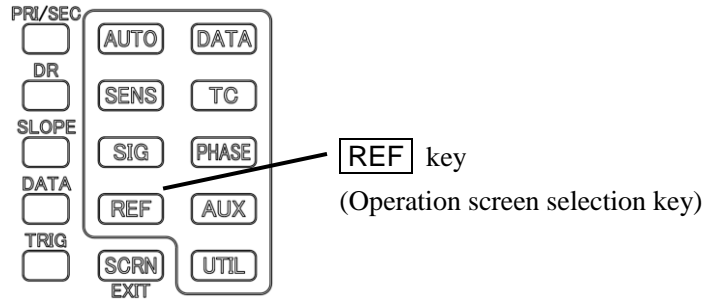

1) Frequency Setting of the Internal Oscillator

{Oscillator Setting Screen}



First press the **REF** key to go to the {Reference Signal Setting Screen}.

Next press the [OSC SET>] soft key to go to the {Oscillator Setting Screen}.

If the detection mode is SINGLE or DUAL1, use the internal oscillator [FREQ>] soft key, but if the detection mode is DUAL2 or CASCADE, press the [PRI FREQ>] soft key to set the primary frequency and press the [SEC FREQ>] soft key to set the secondary frequency.

If REF IN is selected for the reference signal, the [PRI FREQ>] soft key is not displayed in DUAL2 and the [SEC FREQ>] soft key is not displayed in CASCADE.

2) Output Selection of the Internal Oscillator

{OSC Output Oscillator Selection Screen}



A signal synchronized with the internal connector can be output from the OSC OUT connector.

Press the [SEL CH>] soft key to go to the {OSC Output Oscillator Selection Screen}.

Select the output oscillator using the MODIFY knob or up/down keys.

PRI: Synchronized with the primary frequency

SEC: Synchronized with the secondary frequency

6.5 Time Constant Filter Setting (Dual Frequency Measurement)

The time constant filters of the primary and secondary PSDs can be set individually.

{ Time Constant Filter Setting Screen }

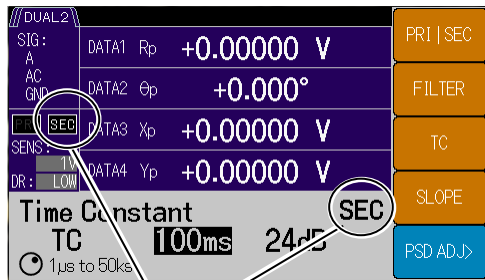

PSD display

To set the time constant, first press the **TC** key to go to the { Time Constant Filter Setting Screen }.

Press the [**PRI | SEC**] soft key to switch between the primary PSD and secondary PSD settings. Configure the setting for each PSD.

The procedure to select the filter (**FILTER**) and set the time constant (**TC**) and attenuation slope (**SLOPE**) is the same as when the detection mode is **SINGLE**.

For details, see "4.6 Time Constant Filter Setting and Characteristics"

The PSD input offset adjustment setting is the same for both PSDs.

If the detection mode is **CASCADE**, a signal to transmit to the secondary PSD may be attenuated depending on the time constant and attenuation slope settings on the primary PSD side. If the output signal of the secondary PSD cannot be detected, decrease the time constant and attenuation slope on the primary PSD side.

6.6 Sensitivity Setting (Dual Frequency Measurement)

The sensitivity of the primary and secondary PSD is set individually.

To set the sensitivity, first press the **[SENS]** key to go to the {Sensitivity Setting Screen}.

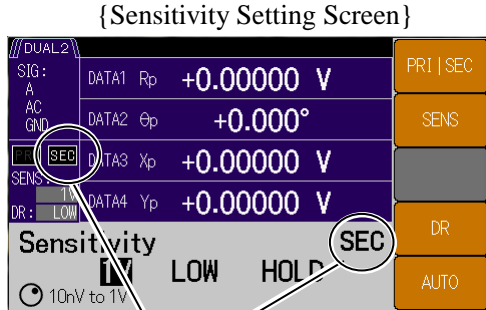

PSD display

Press the [PRI | SEC] soft key to switch between the primary PSD and secondary PSD settings.

Configure the setting for each PSD.

The procedure to set the sensitivity (SENS) and dynamic reserve (DR) is the same as when the detection mode is SINGLE.

The dynamic reserve and auto sensitivity adjustment settings are the same for both PADs.

For details, see "4.7 Sensitivity and Dynamic Reserve Setting"

■ Restrictions

The sensitivity setting of the secondary PSD is lower in level than the sensitivity setting of the primary PSD.

For example, if 100 mV is set for the sensitivity of the primary PSD, the sensitivity of the secondary PSD is limited to less than 100 mV (50 mV, 20 mV, etc.).

6.7 Phase Adjustment (Dual Frequency Measurement)

The phase adjustment range of the primary and secondary PSDs is set individually.

To adjust the phase, first press the **[PHASE]** key to go to the {Phase Adjustment Screen}.

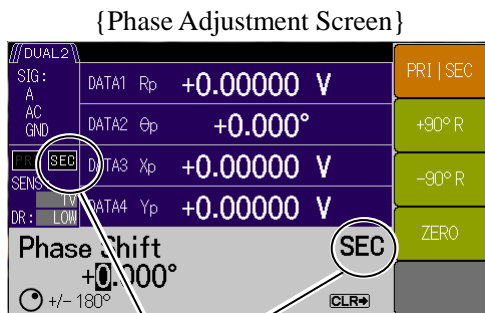

PSD display

Press the [PRI | SEC] soft key to switch between the primary PSD and secondary PSD settings.

Configure the setting for each PSD.

The procedure to adjust the phase setting is the same as when the detection mode is SINGLE.

For details, see "4.8 Phase Adjustment"

6.8 Measured Value Offset and Expansion (Dual Frequency Measurement)

The offset adjustment and expansion of the primary and secondary PSDs are set individually. First go to each setting screen in the following procedure.

1) Offset Adjustment

First press the **DATA** key to go to the {Output Signal Setting Screen}.

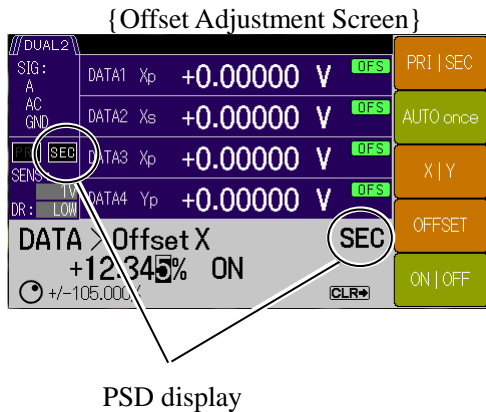

Press the [**OFFSET>**] soft key to go to the {Offset Adjustment Screen}.

Press the [**PRI | SEC**] soft key to switch between the primary PSD and secondary PSD settings.

Configure the setting for each PSD.

The offset adjustment procedure is the same as when the detection mode is SINGLE.

For details,

☞ "5.1 Measured Value Offset and Expansion"

2) Expansion

First press the **DATA** key to go to the {Output Signal Setting Screen}.

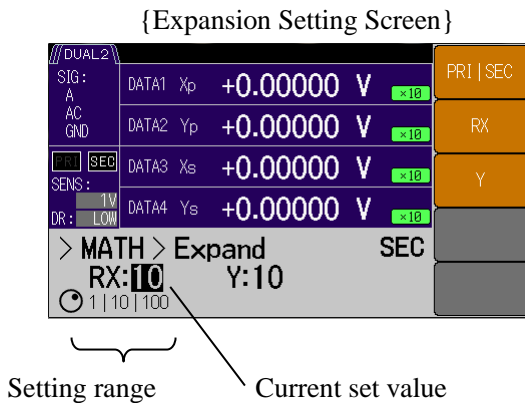

Press the [**MATH>**] soft key to go to the {Math Selection Screen}. Select EXPAND using the MODIFY knob or up/down keys to display the [**EXPAND>**] soft key.

Press the [**EXPAND>**] soft key to go to the {Expand Setting Screen}.

Press the [**PRI | SEC**] soft key to switch between the primary PSD and secondary PSD settings. Configure the setting for each PSD.

Press the [**RX**] or [**Y**] soft key to set the scale factor {x1 | x10 | x100} using the MODIFY knob or up/down keys.

The expansion scale factor for measurement data R and X is shared and the expansion scale factor for Y is set individually.

The apparent sensitivity (signal full scale) can be expanded 0.1 times or 0.01 times using EXPAND.

■ Restrictions

Only PSD outputs X, Y, and R (after X and Y offset adjustment) can be expanded. Other parameters (phase, noise density, and AUX IN) cannot be expanded.

EXPAND is not executed while the normalize arithmetic processing or ratio arithmetic processing is executed.

6.9 Ratio Measurement (Dual Frequency Measurement)

The denominator of the ratio arithmetic processing is always a primary PSD output (Xp, Yp, Rp). If the detection mode is DUAL1 or DUAL2, secondary PSD output (Xs) can be specified as the numerator, in addition to the normal AUX IN.

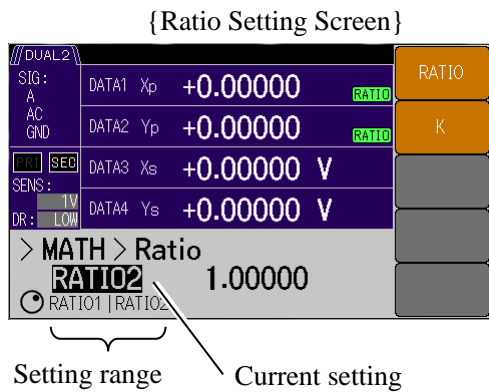

First press the **DATA** key to go to the {Measurement Data Setting Screen}.

Press the [MATH>] soft key to go to the {Math Selection Screen}. Select RATIO using the MODIFY knob or up/down keys to display the [RATIO>] soft key. Press the [RATIO>] soft key to go to the {RATIO Setting Screen}.

Press the [RATIO] soft key to select a RATIO arithmetic expression using the MODIFY knob or up/down keys.

RATIO selection	Contents of arithmetic expression	Detection mode
RATIO1	$K \times (\text{primary PSD } (X_p, Y_p, R_p) \div \text{AUX IN1})$ [%FS]	SINGLE DUAL1 DUAL2
	$K \times (\text{secondary PSD } (X_s, Y_s, R_s) \div \text{AUX IN1})$ [%FS]	CASCADE
RATIO2	$K \times (\text{primary PSD } (X_p, Y_p, R_p) \div \text{secondary PSD } X_s)$ [%FS]	DUAL1 DUAL2

The maximum update rate of the numerator is 10 k samples/s.

However, it may slow down depending on the internal processing.

7. Troubleshooting

7.1 Error Message.....	7-2
7.1.1 Power-On Errors	7-3
7.1.2 Panel Operation Errors.....	7-3
7.1.3 Errors During Measurement	7-4
7.1.4 Signal Overload.....	7-5
7.1.5 Loss of Synchronization	7-5
7.2 Troubleshooting.....	7-6
7.3 Q & A.....	7-7

7.1 Error Message

This chapter describes the errors that can occur during power-on self testing, panel operations and major errors that may occur in the normal course of measurement, with their causes and necessary remedies.

If repair is required, contact NF Corporation or one of our representatives.

When requesting repair of the LI5655 or LI5660, please let us know the contents of any error messages that may be displayed.

Rare events such as malfunctions due to strong external noise may cause error messages not described in this manual to be displayed.

Unusual operations such as firmware updates may cause error messages not described in this manual to be displayed. If other manuals have been provided, refer to them as well.

See the "LI5655 / LI5660 Instruction Manual (Remote Control)" for errors that only occur with remote control. Remote control-related errors display a message box like the following. These error messages automatically disappear after a few seconds.

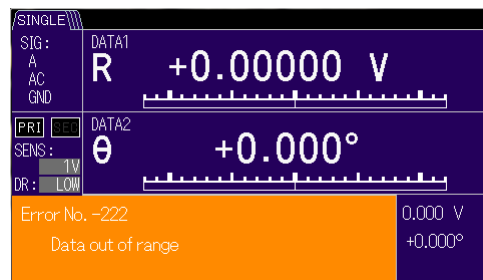

Error Message (Example)

7.1.1 Power-On Errors

If an error occurs during power-on self testing, the following error message is displayed on the startup screen.

Error Message	Contents and Cause	Remedy
Error No.-510 Backup Memory ...Initialized	Initialization occurs when resume memory contents have been lost.	Turn power off and back on. If the error recurs, a fault is present requiring repair.
Calibration ...Uncalibrated	Calibration data has been lost.	A fault is present requiring repair.

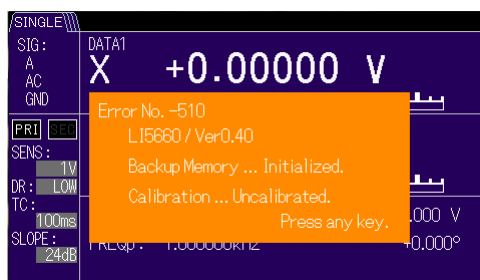

Error Display Screen Example

7.1.2 Panel Operation Errors

Errors displayed regarding panel operations are as follows.

Error Message	Contents and Cause	Remedy										
Error No.-206 Auto-once failed due to unlock	UNLOCK interrupted automatic setting execution. Affected Automatic Settings <table border="1" style="margin-left: 20px;"> <tr><td>AUTO</td><td>→[MEASURE]</td></tr> <tr><td>AUTO</td><td>→[SENS]</td></tr> <tr><td>AUTO</td><td>→[PHASE (PHASE PRI)]</td></tr> <tr><td>AUTO</td><td>→[PHASE SEC]</td></tr> <tr><td>DATA</td><td>→[OFFSET>]→[AUTO once]</td></tr> </table>	AUTO	→[MEASURE]	AUTO	→[SENS]	AUTO	→[PHASE (PHASE PRI)]	AUTO	→[PHASE SEC]	DATA	→[OFFSET>]→[AUTO once]	Check that the reference signal frequency and amplitude are normal and not indicating UNLOCK on the measurement screen.
AUTO	→[MEASURE]											
AUTO	→[SENS]											
AUTO	→[PHASE (PHASE PRI)]											
AUTO	→[PHASE SEC]											
DATA	→[OFFSET>]→[AUTO once]											
Error No.-207 X, Y out of range	The X or Y measurement value is out of range for adjustment, so automatic offset adjustment cannot be performed.	Increase the sensitivity (signal full scale). Or attenuate the input signal.										
Error No.-208 DC compensation value saturation occurred	PSD Adj out of automatic adjustment range. (Occurred only in AUTO once of PSD Adj)	Execute it as a no-signal condition. If the error recurs, a fault may be present. Contact with NF Corporation or one of our representatives.										
Error No.-330 Self-test error	Failure occurred in self-test results.	Check connections and retry self-test. If the error recurs, a fault may be present. Contact with NF Corporation or one of our representatives.										

7.1.3 Errors During Measurement

Errors that may be displayed during measurement are as follows.

Error Message	Contents and Cause	Remedy
Error No.-381 Overheat	The chassis is overheated. 1) Ambient temperature is high. 2) Cooling fan failure.	1) Move to a cooler location or provide more ventilation. Turn the power off and wait for the internal temperature to normalize before turning power back on. 2) Ask NF Corporation or one of our representatives for repair.
Error No.-382 Line over voltage	Power source overvoltage detected.	Turn off the power and check that voltage at the power outlet is within the voltage range of this product. Also make sure the power voltage selection switch is set correctly before turning back on.
Error No.-383 Internal communication error	An internal communication error occurred.	Turn power off and back on. If the error recurs, a fault is present requiring repair.

The above error messages remain displayed. Key-lock and lamp-off are canceled, but panel and remote operations are ignored and the screen does not update.

Turn the power off and apply the remedy.

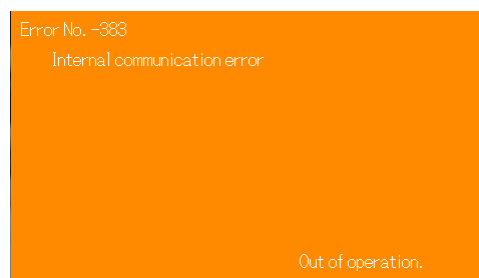

The internal communication error appears on all screens.

Error Display Screen Example

7.1.4 Signal Overload

If an excessive signal level is detected anywhere on the signal path from input to output and measurement is impossible, an icon is displayed in the screen.

For details, see "4.7.3 Signal Over-level Display and Monitor Output"

Over-level Status	Description	Remedy
PROTECT	Voltage exceeding the maximum input voltage was detected in the A or B connector. Both the A and B connectors are internally separated temporarily for protection.	Lower the signal level applied to the A or B connector. Use the C connector. (For the LI5660 only)
IN/OUT	Both events described in INPUT and OUTPUT below occurred.	(See below)
INPUT	Over-level occurred in the AC amplification part from the signal input connector to primary PSD input. The PSD input signal can be checked with the MONITOR OUT connector.	Increase the sensitivity (signal full scale). Increase the dynamic reserve. If a DC component is included in the input signal, use the AC coupling. Set the line filter to ON to attenuate the noise coming from the power supply.
OUTPUT	Over-level occurred in the signal processing part of the PSD output (time constant filter and DC amplification part). The output voltage allowable range was exceeded as a result of an OFFSET, EXPAND, NORMALIZE, RATIO, or other arithmetic processing. Measurement parameters that are not output and displayed are also included in the scope.	Increase the time constant and attenuation slope to attenuate the noise. Increase the sensitivity (signal full scale). Cancel the arithmetic processing and check the original signals (X, Y, R, AUX IN 1). Then configure the setting again so the output does not exceed the maximum level.
AUX	Excessive input into the AUX IN 1 or AUX IN 2 connector.	Lower the signal level applied to the AUX IN 1 or AUX IN 2 connector.

When more than one event occurs at the same time, their display priority status is according to the above table.

7.1.5 Loss of Synchronization

If the external reference signal or measurement signal is set for the reference signal source and they are not synchronized, the UNLOCK status is displayed in the measurement screen.

In such cases, check the waveform selection of the external reference signal, and that the actual reference signal amplitude, waveform and frequency are within the range of synchronization.

For details, see "4.4 Reference Signal Setting and Connection", "9.3 Reference Signal System"

If synchronization does not occur with a reference signal that is within the specified range and without noise or instability, ask us or our agent for repair.

7.2 Troubleshooting

If you suspect a problem, check the following list for a solution at once. If the problem is not resolved or remains unchanged after applying the suggested remedy, contact us or our agent.

Table 7-1 In case of suspected anomaly

Description	Possible Cause	Remedy
Power cannot be turned on	Bad power cord connection.	Securely plug in the power cord.
	The power source is out of the rated range.	Use a meter or other method to check the voltage at the power outlet. Check the setting of the line voltage selector switch on the rear. Be sure the power cord is unplugged when changing the setting of the line voltage selector switch.
	The fuse is blown.	Unplug the power cord and after checking that the source voltage matches the setting of the line voltage selector switch, replace the fuse. Even though the fuse has blown, because it indicates a failure, ask us or our agent for repair.
Panel Operation Disabled	The keys are locked.	If the KEY LOCK lamp is lit, press and hold the [CLR] key until the measurement screen disappears and then reappears. Release the key when the screen reappears. The KEY LOCK lamp turns off and panel operation is restored.
	Remote control is enabled.	If the REMOTE lamp is lit, press the [CLR] /LOCAL key to re-enable local control. In the Local Lock Out state, this operation is disabled. Use the external controller to re-enable local control.
If the instructions do not work as described	Settings are not initialized.	Many descriptions presume settings have been initialized. Try again after initializing by pressing the [UTIL] , [RESET>] , [Exec] key sequence.
Cooling fan sound increased	The fan may be faulty or deteriorated.	Ask NF Corporation or our agents for repair.

7.3 Q & A

Q1. I want to measure the peak voltage of the pulse signal.

Do the lock-in amplifier voltage V units represent V_{peak} ?

A1. The lock-in amplifier cannot measure peak values.

This instrument measures the effective value (V_{rms}) of the fundamental wave component of repetitive signals.

When measuring a pulse signal with the lock-in amplifier, the measured value depends on the pulse waveform characteristics (such as peak value, pulse width and duty cycle). If the waveform characteristics are already known, the peak value can be calculated from the effective value, although if the duty cycle is low, the S/N (signal-to-noise ratio) is low because the majority of the period has no signal (mostly noise). Also isolated one-shot pulse signals cannot be measured.

Q2. I want to view the signal waveform. Is it possible to reproduce the waveform buried in noise?

A2. The lock-in amplifier cannot display waveforms.

If the signal continuously repeats, a rough waveform might be compounded from the measured fundamental wave and harmonic components, but we do not recommend this because of the likelihood of large errors. Especially at high frequency, a correct waveform cannot be obtained because of high harmonic phase shift.

Q3. Can DC voltage be measured?

A3. The lock-in amplifier cannot measure DC signal.

Only AC signals can be measured. When changed to AC signals by amplitude modulation, DC signals can be measured. However in this case modulator gain must be calibrated.

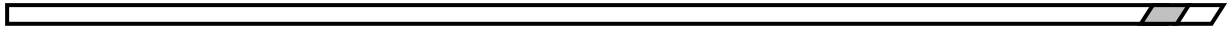

(Blank)

8. Maintenance

8.1 Preface	8-2
8.2 Daily Maintenance.....	8-3
8.3 Storage, Repacking, and Transportation	8-3
8.4 Version Confirmation.....	8-4
8.5 Main Function Confirmation	8-5
8.5.1 Self Test.....	8-5
8.6 Performance Test.....	8-6
8.6.1 Preface.....	8-6
8.6.2 Isolation Confirmation.....	8-8
8.6.3 Voltage Measurement Accuracy	8-10
8.6.4 Current Measurement Accuracy	8-16
8.6.5 Analog Output Voltage Accuracy of Measured Values.....	8-18
8.6.6 Common Mode Rejection Ratio.....	8-20
8.6.7 Input referred noise.	8-21
8.6.8 Phase Accuracy.....	8-22
8.6.9 Frequency Accuracy.....	8-24
8.6.10 Amplitude Accuracy of Internal Oscillator Sine Wave Output	8-25
8.6.11 AUX IN DC Voltage Measurement Accuracy.....	8-26
8.6.12 AUX OUT RMS Voltage Accuracy	8-27
8.7 Calibration	8-28
8.8 Maintenance Information.....	8-29

8.1 Preface

The following maintenance tasks are required to keep the instrument in top operating condition.

- Operation Inspection Check whether the instrument operates correctly.
- Performance Test Check whether the instrument satisfies the specified ratings.
- Adjustment and Calibration If the ratings are not satisfied, adjustment and calibration are performed by NF Corporation to recover proper performance.
- Fault Repair If performance is not improved, NF Corporation checks the cause and location of the fault, and repair.

This manual describes basic operation checking and performance testing procedures.

For advanced inspection, adjustment, calibration and fault repair, contact NF Corporation or our agent.

 **WARNING**

There are high voltage parts inside this device. Never remove the cover.

No one except trained service technicians who have knowledge of hazard prevention is authorized to check the inside of this device.

8.2 Daily Maintenance

Install the LI5655 / LI5660 in a location that satisfies the installation conditions.

For details, see "2.2.2 Installation Conditions".

The front panel of the LI5655 / LI5660 is made of plastic. Avoid damage from contact with sharp or hot objects.

When the panel or case needs cleaning, wipe with a soft cloth. To remove persistent contamination, wipe with a soft cloth soaked with neutral detergent and wrung out. Do not use any organic solvents like thinner or benzene, or any chemical cleaning cloth, as they may cause the surface finish to deteriorate, tarnish, or come off.

8.3 Storage, Repacking, and Transportation

Store the LI5655 / LI5660 in a location that satisfies the installation conditions.

For details, see "2.2.2 Installation Conditions".

When repacking for transport, use a carton with adequate strength and enough space for sufficient padding to withstand the weight and protect the instrument.

During transport, handle with care to avoid strong impact.

8.4 Version Confirmation

The same model products may have different version numbers due to functional improvements and fault repairs. Behavior can differ according to version, so if an anomaly is detected, provide us with the version information along with the symptoms.

Our website may provide guidance for updating the firmware.

After startup, the version information can be confirmed by the following procedure.

First, press the **UTIL** key to move to the {Utility Screen}.

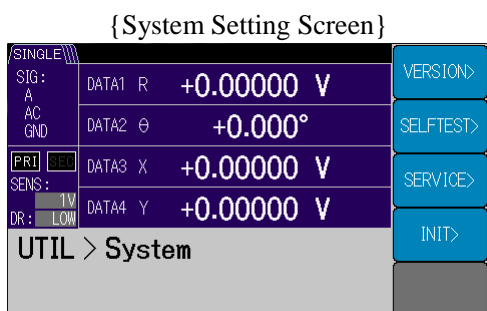
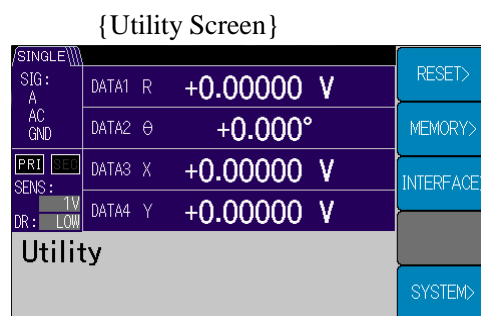
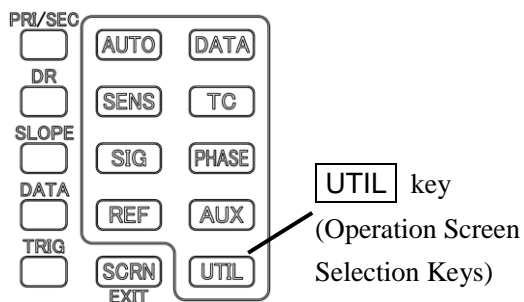

Press the [SYSTEM>] soft key to go to the {System Setting Screen}.

Press the [VERSION>] soft key to go to the {Version Information Screen}.

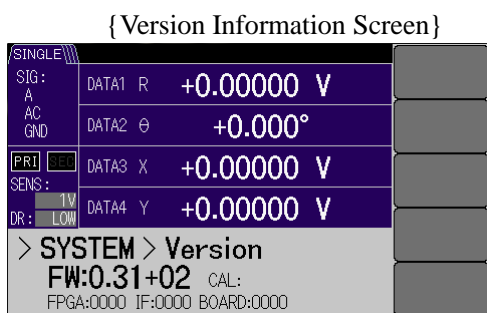

FW : Firmware version
 Cal : Last calibration date
 FPGA : FPGA version
 IF : Interface version
 BOARD : Board version

To return to the top level operating screen, press

SCRIN / EXIT.

8.5 Main Function Confirmation

Before performance testing, check the basic operation of the LI5655 / LI5660 by referring to "2.4 Simplified Operation Check".

8.5.1 Self Test

To execute self testing of the LI5655 / LI5660, move to the {Self Diagnosis Screen}.

{Self Diagnosis Screen}

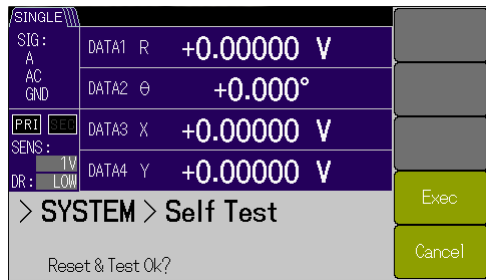

First, press the **UTIL** key to move to the {Utility Screen}, then press the [SYSTEM>] soft key to go to the {System Setting Screen}, then press the [SELF TEST>] soft key to go to the {Self Diagnosis Screen}.

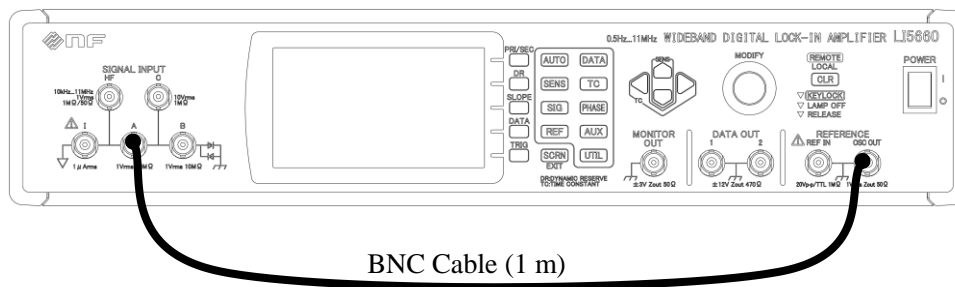

Connect the OSC OUT and the "A" of SIGNAL INPUT with a BNC cable (1 m).

Press the [Exec] soft key on the {Self Diagnosis Screen} to execute the self test.

Allow several tens of seconds for the self test.

8.6 Performance Test

8.6.1 Preface

A performance test is performed as part of preventative maintenance to prevent performance deterioration of the LI5655 / LI5660.

A performance test is conducted when necessary to verify performance during acceptance inspection, periodic inspection and after repair.

The simple performance test described here is performed using commercially available standards and measurement instruments. For advanced testing, ask NF Corporation or one of our agents. We handle requests for a fee.

If the specifications are not satisfied after a performance test, calibration or repair. Contact with NF Corporation or one of our agents.

1) Test environment confirmation

Conduct performance testing in the following environment.

- Ambient temperature : 23 \pm 5°C
- Ambient humidity : 20 to 70% RH, non-condensing
- Power supply voltage : 100 or 120 V AC \pm 10%, or 230 V AC +10%, -14%
- Warm-up time : At least 30 minutes

2) Test preparation

Before a performance test, initialize the settings.

To initialize the settings, press the **UTIL** key, **[RESET>]** soft key, and the **[Exec]** soft key, in that order.

For details, see "4.2 Simple Operation Procedure for Using the Device for the First Time"

3) Needed equipment

The following measurement equipment is required for operation inspection and performance testing.

Name	Required Capability	Example Model
Generator	Waveform: Sine wave Frequency: 0.5 Hz to 11 MHz Amplitude: 100 mVrms to 7 Vrms TTL output synchronized with sine wave	WF1947 (NF Corp.)
Digital Multi Meter (DMM)	AC Voltmeter (true rms) (100 mV to 10 V range) Accuracy: $\pm 0.1\%$ (10 Hz to 20 kHz) DC Voltmeter (100 mV to 100 V range) Accuracy: $\pm 0.04\%$ Ohmmeter (100 k Ω range [10 μ A]) (100 Ω range [1 mA]) Accuracy: $\pm 0.05\%$	34401A (Keysight)
RMS Voltmeter (true rms)	(100 mV to 10 V range) Frequency response correction should be enabled. Accuracy: $\pm 0.5\%$ (to 100 kHz) Accuracy: $\pm 0.7\%$ (to 1 MHz) Accuracy: $\pm 1\%$ (to 3 MHz) Accuracy: $\pm 4\%$ (to 11 MHz)	URE3 (Rohde & Schwarz)
Frequency Counter	Accuracy : ± 10 ppm, Resolution : 1 ppm or higher	53131A (Keysight)
Oscilloscope	Bandwidth: at least 10 MHz and 10 s/div	GDS2842 (NF Corp.)
Others		
BNC Cable	50 Ω , BNC, RG58/U equiv.	
Alligator Clip Cable	BNC-Alligator Clip Cable, and others	
Terminator	50 Ω , BNC	
Shorted Plug	BNC	
Divider	BNC, T-type	
Power Splitter	BNC, 50 Ω , 2-way	

8.6.2 Isolation Confirmation

Confirm the floating function of the signal input section.

In the following setting descriptions, LI 56xx represents both the LI5655 and LI5660.

1) Floating resistance confirmation

LI 56xx settings	: Set the signal ground to FLOAT.
Measurement instrument settings	: Set the DMM to resistance mode. Set the measurement range to 100 k Ω (test current 10 μ A or less).
Connections	: Connect the HOT side of the DMM to the COLD side of the signal input connector (e.g., A). Connect the COLD side of the DMM to chassis ground (e.g., COLD side of MONITOR OUT).
Measurement method	: Measure the DC resistance between HOT and COLD sides of the DMM.
Judgment (Pass Range)	: DC resistance = 8 k Ω to 11 k Ω (about 9.6 k Ω)

2) Ground resistance confirmation

LI 56xx settings	: Set the signal ground to GND.
Measurement instrument settings	: Set the DMM to resistance mode. Set the measurement range to 100 Ω (test current 10 mA or less).
Connections	: Connect the HOT side of the DMM to the COLD side of the signal input connector (e.g., A). Connect the COLD side of the DMM to chassis ground (e.g., COLD side of MONITOR OUT).
Measurement method	: Measure the DC resistance between HOT and COLD sides of the DMM.
Judgment (Pass Range)	: DC resistance = 10 Ω to 13 Ω (about 11 Ω)

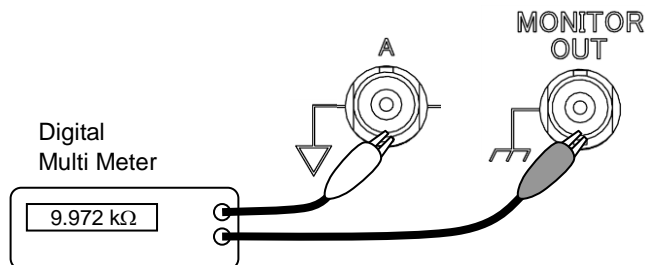

3) Clamp diode confirmation

- LI 56xx settings : Set the signal ground to FLOAT.
Display AUX1 for DATA1.
AUX OUT1 is +10 V and -10 V
- Measurement instrument settings : ———
- Connections : Connect the HOT sides of AUX IN1 and AUX OUT1 to the COLD side of the signal input connector (ex. A). Connect the COLD sides of AUX IN1 and AUX OUT1 to chassis ground (eg., COLD side of MONITOR OUT).
- Measurement method : With AUX OUT1 set to +10 V or -10 V, read the DATA1 (AUX IN1) measurement value (displayed).
- Judgment (Pass Range) : AUX IN 1 measured value = +1.2 V to +1.6 V (about +1.4 V), and -1.6 V to -1.2 V (about -1.4 V)

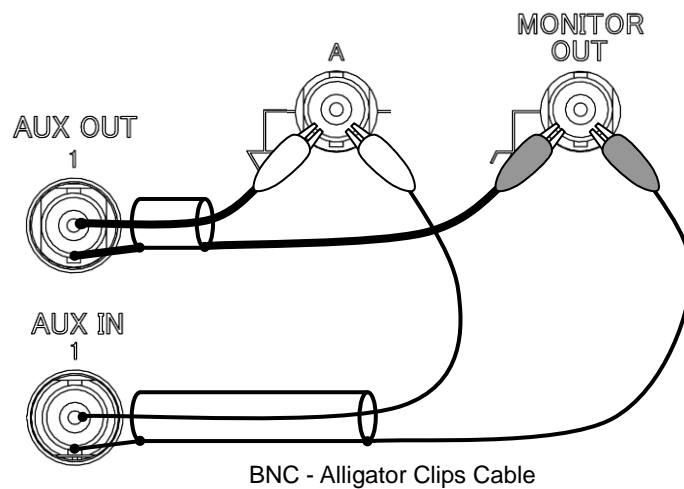

8.6.3 Voltage Measurement Accuracy

The following method cannot be used to test very small signal measurement accuracy. As testing very small signal measurement accuracy requires a separate precision attenuator, contact NF Corporation or our agent. The lock-in amplifier measures only fundamental frequency component. In contrast, general-purpose standard voltmeters measure effective (rms) values that include harmonic distortion and noise. Therefore, sufficient measurement accuracy cannot be obtained at low voltage.

In the following setting descriptions, LI 56xx represents both the LI5655 and LI5660. Also, the LI5660 is shown in the connection diagrams.

*1: Only the LI5660 is equipped with the C and HF connectors.

1) Input A

- LI56xx settings : Use connector A for signal input, and set the input coupling to AC. Set the signal ground to FLOAT. Use INT OSC (internal oscillator) as the reference signal source. Set the DR setting to LOW. Set the time constant to 100 ms. Set the attenuation slope to 24 dB/oct (SYNC OFF). Set measurement parameter DATA1 to R. Frequency, amplitude and sensitivity are per the following table.
- Measurement instrument settings : For 100 kHz or less, use the DMM in AC voltage mode. For 100 kHz to 3 MHz, use a RMS Voltmeter.
- Connections : Connect a BNC cable from one side of a divider at the LI56xx OSC OUT connector to connector A. Connect a BNC cable from the other side of the divider to the DMM.
- Measurement method : Select the following specified frequencies, amplitudes and sensitivities, and read the measurement values at DATA1 and the DMM (or RMS Voltmeter).
- Judgment (Pass Range) : Per the following table.

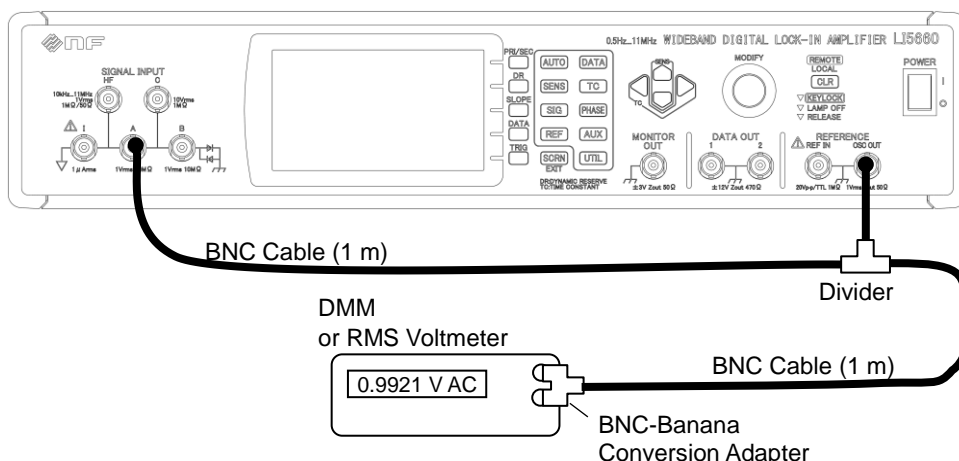

8.6 Performance Test

Judgment

Frequency	Sensitivity (rms)	INT OSC Amplitude Setting (rms)	R: Measured Value (rms) S: Voltmeter Reading (rms) R/S	Pass Range (R/S)				
20 kHz	1 V	1 V	<table style="width: 100%; border-collapse: collapse;"> <tr><td style="width: 50%; text-align: right;">--·----- V</td><td style="width: 50%;"></td></tr> <tr><td style="width: 50%; text-align: right;">--·----- V</td><td style="width: 50%; text-align: left;">--·-----</td></tr> </table>	--·----- V		--·----- V	--·-----	0.995 to 1.005
	--·----- V							
	--·----- V	--·-----						
	500 mV	500 mV	<table style="width: 100%; border-collapse: collapse;"> <tr><td style="width: 50%; text-align: right;">-----·_ mV</td><td style="width: 50%;"></td></tr> <tr><td style="width: 50%; text-align: right;">-----·_ mV</td><td style="width: 50%; text-align: left;">--·-----</td></tr> </table>	-----·_ mV		-----·_ mV	--·-----	
-----·_ mV								
-----·_ mV	--·-----							
200 mV	200 mV	<table style="width: 100%; border-collapse: collapse;"> <tr><td style="width: 50%; text-align: right;">-----·_ mV</td><td style="width: 50%;"></td></tr> <tr><td style="width: 50%; text-align: right;">-----·_ mV</td><td style="width: 50%; text-align: left;">--·-----</td></tr> </table>	-----·_ mV		-----·_ mV	--·-----		
-----·_ mV								
-----·_ mV	--·-----							
100 mV	100 mV	<table style="width: 100%; border-collapse: collapse;"> <tr><td style="width: 50%; text-align: right;">-----·_ mV</td><td style="width: 50%;"></td></tr> <tr><td style="width: 50%; text-align: right;">-----·_ mV</td><td style="width: 50%; text-align: left;">--·-----</td></tr> </table>	-----·_ mV		-----·_ mV	--·-----		
-----·_ mV								
-----·_ mV	--·-----							
50 kHz	1 V	1 V	<table style="width: 100%; border-collapse: collapse;"> <tr><td style="width: 50%; text-align: right;">-----·_ mV</td><td style="width: 50%;"></td></tr> <tr><td style="width: 50%; text-align: right;">-----·_ mV</td><td style="width: 50%; text-align: left;">--·-----</td></tr> </table>	-----·_ mV		-----·_ mV	--·-----	0.99 to 1.01
	-----·_ mV							
	-----·_ mV	--·-----						
	500 mV	500 mV	<table style="width: 100%; border-collapse: collapse;"> <tr><td style="width: 50%; text-align: right;">-----·_ mV</td><td style="width: 50%;"></td></tr> <tr><td style="width: 50%; text-align: right;">-----·_ mV</td><td style="width: 50%; text-align: left;">--·-----</td></tr> </table>	-----·_ mV		-----·_ mV	--·-----	
-----·_ mV								
-----·_ mV	--·-----							
200 mV	200 mV	<table style="width: 100%; border-collapse: collapse;"> <tr><td style="width: 50%; text-align: right;">-----·_ mV</td><td style="width: 50%;"></td></tr> <tr><td style="width: 50%; text-align: right;">-----·_ mV</td><td style="width: 50%; text-align: left;">--·-----</td></tr> </table>	-----·_ mV		-----·_ mV	--·-----		
-----·_ mV								
-----·_ mV	--·-----							
100 mV	100 mV	<table style="width: 100%; border-collapse: collapse;"> <tr><td style="width: 50%; text-align: right;">-----·_ mV</td><td style="width: 50%;"></td></tr> <tr><td style="width: 50%; text-align: right;">-----·_ mV</td><td style="width: 50%; text-align: left;">--·-----</td></tr> </table>	-----·_ mV		-----·_ mV	--·-----		
-----·_ mV								
-----·_ mV	--·-----							
100 kHz	1 V	1 V	<table style="width: 100%; border-collapse: collapse;"> <tr><td style="width: 50%; text-align: right;">-----·_ mV</td><td style="width: 50%;"></td></tr> <tr><td style="width: 50%; text-align: right;">-----·_ mV</td><td style="width: 50%; text-align: left;">--·-----</td></tr> </table>	-----·_ mV		-----·_ mV	--·-----	0.98 to 1.02
	-----·_ mV							
	-----·_ mV	--·-----						
	200 mV	500 mV	<table style="width: 100%; border-collapse: collapse;"> <tr><td style="width: 50%; text-align: right;">-----·_ mV</td><td style="width: 50%;"></td></tr> <tr><td style="width: 50%; text-align: right;">-----·_ mV</td><td style="width: 50%; text-align: left;">--·-----</td></tr> </table>	-----·_ mV		-----·_ mV	--·-----	
-----·_ mV								
-----·_ mV	--·-----							
100 mV	200 mV	<table style="width: 100%; border-collapse: collapse;"> <tr><td style="width: 50%; text-align: right;">-----·_ mV</td><td style="width: 50%;"></td></tr> <tr><td style="width: 50%; text-align: right;">-----·_ mV</td><td style="width: 50%; text-align: left;">--·-----</td></tr> </table>	-----·_ mV		-----·_ mV	--·-----		
-----·_ mV								
-----·_ mV	--·-----							
100 mV	100 mV	<table style="width: 100%; border-collapse: collapse;"> <tr><td style="width: 50%; text-align: right;">-----·_ mV</td><td style="width: 50%;"></td></tr> <tr><td style="width: 50%; text-align: right;">-----·_ mV</td><td style="width: 50%; text-align: left;">--·-----</td></tr> </table>	-----·_ mV		-----·_ mV	--·-----		
-----·_ mV								
-----·_ mV	--·-----							
1 MHz	1 V	1 V	<table style="width: 100%; border-collapse: collapse;"> <tr><td style="width: 50%; text-align: right;">--·----- V</td><td style="width: 50%;"></td></tr> <tr><td style="width: 50%; text-align: right;">--·----- V</td><td style="width: 50%; text-align: left;">--·-----</td></tr> </table>	--·----- V		--·----- V	--·-----	0.97 to 1.03
	--·----- V							
	--·----- V	--·-----						
	500 mV	500 mV	<table style="width: 100%; border-collapse: collapse;"> <tr><td style="width: 50%; text-align: right;">-----·_ mV</td><td style="width: 50%;"></td></tr> <tr><td style="width: 50%; text-align: right;">-----·_ mV</td><td style="width: 50%; text-align: left;">--·-----</td></tr> </table>	-----·_ mV		-----·_ mV	--·-----	
-----·_ mV								
-----·_ mV	--·-----							
200 mV	200 mV	<table style="width: 100%; border-collapse: collapse;"> <tr><td style="width: 50%; text-align: right;">-----·_ mV</td><td style="width: 50%;"></td></tr> <tr><td style="width: 50%; text-align: right;">-----·_ mV</td><td style="width: 50%; text-align: left;">--·-----</td></tr> </table>	-----·_ mV		-----·_ mV	--·-----		
-----·_ mV								
-----·_ mV	--·-----							
100 mV	100 mV	<table style="width: 100%; border-collapse: collapse;"> <tr><td style="width: 50%; text-align: right;">-----·_ mV</td><td style="width: 50%;"></td></tr> <tr><td style="width: 50%; text-align: right;">-----·_ mV</td><td style="width: 50%; text-align: left;">--·-----</td></tr> </table>	-----·_ mV		-----·_ mV	--·-----		
-----·_ mV								
-----·_ mV	--·-----							
3 MHz	1 V	1 V	<table style="width: 100%; border-collapse: collapse;"> <tr><td style="width: 50%; text-align: right;">--·----- V</td><td style="width: 50%;"></td></tr> <tr><td style="width: 50%; text-align: right;">--·----- V</td><td style="width: 50%; text-align: left;">--·-----</td></tr> </table>	--·----- V		--·----- V	--·-----	0.95 to 1.05
	--·----- V							
	--·----- V	--·-----						
	500 mV	500 mV	<table style="width: 100%; border-collapse: collapse;"> <tr><td style="width: 50%; text-align: right;">-----·_ mV</td><td style="width: 50%;"></td></tr> <tr><td style="width: 50%; text-align: right;">-----·_ mV</td><td style="width: 50%; text-align: left;">--·-----</td></tr> </table>	-----·_ mV		-----·_ mV	--·-----	
-----·_ mV								
-----·_ mV	--·-----							
200 mV	200 mV	<table style="width: 100%; border-collapse: collapse;"> <tr><td style="width: 50%; text-align: right;">-----·_ mV</td><td style="width: 50%;"></td></tr> <tr><td style="width: 50%; text-align: right;">-----·_ mV</td><td style="width: 50%; text-align: left;">--·-----</td></tr> </table>	-----·_ mV		-----·_ mV	--·-----		
-----·_ mV								
-----·_ mV	--·-----							
100 mV	100 mV	<table style="width: 100%; border-collapse: collapse;"> <tr><td style="width: 50%; text-align: right;">-----·_ mV</td><td style="width: 50%;"></td></tr> <tr><td style="width: 50%; text-align: right;">-----·_ mV</td><td style="width: 50%; text-align: left;">--·-----</td></tr> </table>	-----·_ mV		-----·_ mV	--·-----		
-----·_ mV								
-----·_ mV	--·-----							

2) Input C*1

- LI56xx settings : Use connector C for signal input.
 Set the signal ground to FLOAT.
 Use REF IN (external reference signal) for the reference signal source.
 Select the TTL+ reference signal waveform.
 Set the DR setting to LOW.
 Set the time constant to 100 ms.
 Set the attenuation slope to 24 dB/oct (SYNC OFF).
 Set measurement parameter DATA1 to R.
 Frequency, amplitude and sensitivity are per the following table.
- Measurement instrument settings : For 100 kHz or less, use the DMM in AC voltage mode.
 For 100 kHz to 3 MHz, use a RMS Voltmeter.
 Set the generator to sine wave.
- Connections : Connect the BNC cable from the generator synchronous output (SYNC OUT) connector to the LI56xx REF IN connector. : Connect a BNC cable from one side of a divider at the generator output connector to connector C. Connect a BNC cable from the other side of the divider to the DMM.
- Measurement method : Select the following specified frequencies, amplitudes and sensitivities, and read the measurement values at DATA1 and the DMM (or RMS Voltmeter).
- Judgment (Pass Range) : Per the following table.

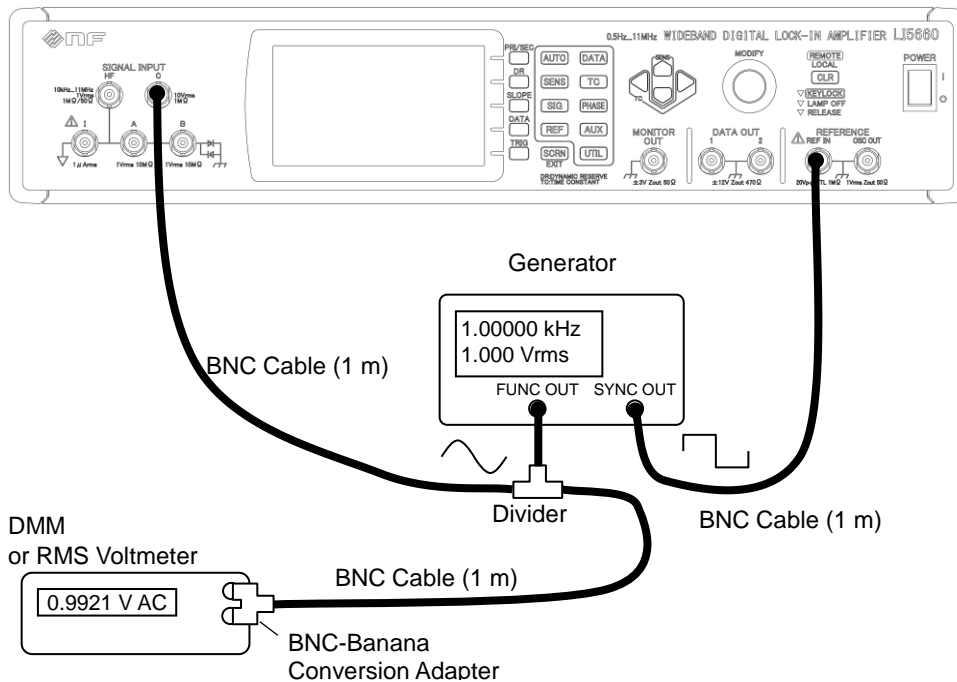

8.6 Performance Test

Judgment

Frequency	Sensitivity (rms)	Generator (no load) Amplitude Setting (rms)	R: Measured Value (rms) S: Voltmeter Reading (rms)	R/S	Pass Range (R/S)
20 kHz	10 V	7 V	-.---- V -.---- V	-.----	0.995 to 1.005
	5 V	5 V	-.---- V -.---- V	-.----	
	2 V	2 V	-.---- V -.---- V	-.----	
	1 V	1 V	-.---- V -.---- V	-.----	
50 kHz	10 V	7 V	-.---- V -.---- V	-.----	0.99 to 1.01
	5 V	5 V	-.---- V -.---- V	-.----	
	2 V	2 V	-.---- V -.---- V	-.----	
	1 V	1 V	-.---- V -.---- V	-.----	
100 kHz	10 V	7 V	-.---- V -.---- V	-.----	0.98 to 1.02
	5 V	5 V	-.---- V -.---- V	-.----	
	2 V	2 V	-.---- V -.---- V	-.----	
	1 V	1 V	-.---- V -.---- V	-.----	
1 MHz	10 V	7 V	-.---- V -.---- V	-.----	0.97 to 1.03
	5 V	5 V	-.---- V -.---- V	-.----	
	2 V	2 V	-.---- V -.---- V	-.----	
	1 V	1 V	-.---- V -.---- V	-.----	
3 MHz	10 V	7 V	-.---- V -.---- V	-.----	0.95 to 1.05
	5 V	5 V	-.---- V -.---- V	-.----	
	2 V	2 V	-.---- V -.---- V	-.----	
	1 V	1 V	-.---- V -.---- V	-.----	

3) Input HF *1

- LI56xx settings : Use the HF connector for signal input.
 Set the signal ground to FLOAT.
 Use REF IN for the reference signal source.
 Select the TTL+ reference signal waveform.
 Set the DR setting to LOW.
 Set the time constant to 100 ms.
 Set the attenuation slope to 24 dB/oct (SYNC OFF).
 Set measurement parameter DATA1 to R.
 Frequency, amplitude, sensitivity and input impedance are per the following table.
- Measurement instrument settings : Use the RMS Voltmeter.
 Set the generator to sine wave.
- Connections : Connect the BNC cable from the generator synchronous output (SYNC OUT) connector to the LI56xx REF IN connector. : Connect a BNC cable from one side of a divider at the generator output connector to connector HF. Connect a BNC cable from the other side of the divider to the DMM.
- Measurement method : Select the following specified frequencies, amplitudes, sensitivities and input impedances, and read the measurement values at DATA1 and the RMS Voltmeter.
- Judgment (Pass Range) : Per the following table.

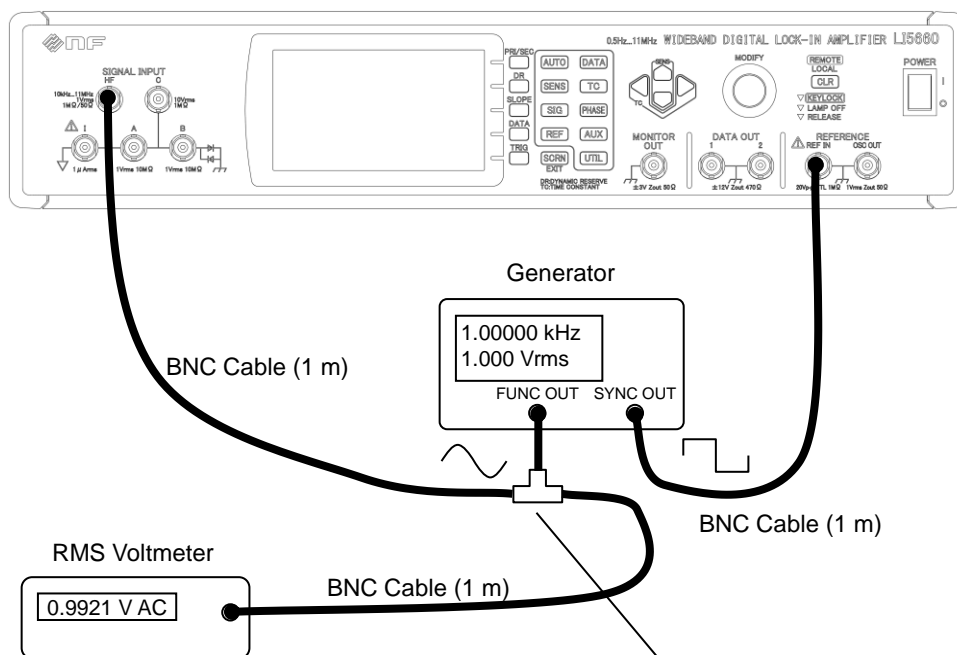

* When the LI 56xx is set to 50 Ω , install a 50 Ω terminator at the RMS Voltmeter.

Divider
 With the 50 Ω setting, use a Power Splitter

8.6 Performance Test

Judgment

Frequency (Z _{in})	Sensitivity (rms)	Generator (no load) Amplitude Setting (rms)	R: Measured Value (rms) S: Voltmeter Reading (rms) R/S	Pass Range (R/S)
1MHz (1 MΩ)	1 V	1 V	-.---- V -.---- V -.----	0.97 to 1.03
	500 mV	500 mV	----. _ mV ----. _ mV -.----	
	200 mV	200 mV	----. _ mV ----. _ mV -.----	
	100 mV	100 mV	----. _ mV ----. _ mV -.----	
3MHz (1 MΩ)	1 V	1 V	-.---- V -.---- V -.----	0.95 to 1.05
	500 mV	500 mV	----. _ mV ----. _ mV -.----	
	200 mV	200 mV	----. _ mV ----. _ mV -.----	
	100 mV	100 mV	----. _ mV ----. _ mV -.----	
10MHz (50 Ω)	1 V	3 V	-.---- V -.---- V -.----	0.93 to 1.07
	500 mV	1.5 V	----. _ mV ----. _ mV -.----	
	200 mV	600 mV	----. _ mV ----. _ mV -.----	
	100 mV	300 mV	----. _ mV ----. _ mV -.----	
11MHz (50 Ω)	1 V	3 V	-.---- V -.---- V -.----	0.86 to 1.14
	500 mV	1.5 V	----. _ mV ----. _ mV -.----	
	200 mV	600 mV	----. _ mV ----. _ mV -.----	
	100 mV	300 mV	----. _ mV ----. _ mV -.----	

8.6.4 Current Measurement Accuracy

- LI56xx settings : Use connector I for signal input.
 Set the input coupling to DC.
 Set the signal ground to FLOAT.
 Use INT OSC as the reference signal source.
 Set the DR setting to LOW.
 Set the time constant to 200 ms.
 Set the attenuation slope to 24 dB/oct (SYNC OFF).
 Set measurement parameter DATA1:R.
 Frequency, amplitude, sensitivity and current input conversion gain are per the following table.
- Measurement instrument settings : Set the DMM to AC voltage mode.
- Connections : Connect a BNC cable from one side of a divider at the LI56xx OSC OUT connector via the V-I conversion jig to connector I.
 Connect a BNC cable from the other side of the divider to the DMM.
- Measurement method : Select the following specified frequencies, amplitudes, sensitivities and current input conversion gains, and read the measurement values at DATA1 and the DMM.
- Judgment (Pass Range) : Per the following table.

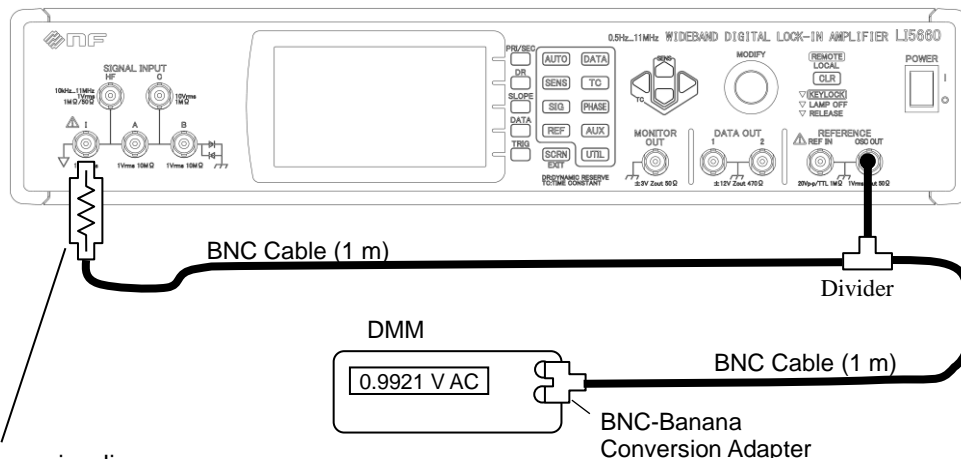

V-I Conversion Jig:

Uses a resistor of precisely known value.
 To suppress noise, keep the resistor in a shielded case with the BNC connectors.

- Prepare a 1 M Ω resistor for 1 M conversion gain.
- Prepare a 100 M Ω resistor for 100 M conversion gain.

Judgment

Sensitivity (rms) Conversion Gain	Frequency	INT OSC Amplitude Setting (rms)	P: Jig Resistance Value R: Measured Value (rms) S: Voltmeter Reading (rms)	$P \times R/S$	Pass Range ($P \times R/S$)
1 μ A 1M	1 kHz	1 V	- . - - - - M Ω - . - - - - μ A - . - - - - V	- . - - - -	0.99 to 1.01
10 nA 100M	125 Hz	1 V	- - - . - - M Ω - - . - - - nA - . - - - - V	- . - - - -	0.99 to 1.01

If, for example, the available accuracy of the 100 M Ω resistor is $\pm 1\%$, the pass range is expanded to 0.98 to 1.02, and judgment is an approximation. To improve accuracy, use a 10 M Ω resistor instead of 100 M Ω , and use 1/10th of the LI56xx INT OSC amplitude setting. In this case, because the LI56xx effective input impedance is about 100 k Ω , the pass range is 0.98 to 1.00 and the judgment is an approximation.

8.6.5 Analog Output Voltage Accuracy of Measured Values

- LI56xx settings : Use connector A for signal input.
Set the input coupling to AC.
Set the signal ground to FLOAT.
Use INT OSC (internal oscillator) as the reference signal source.
Set the frequency to 1 kHz and amplitude to 0 V (rms).
Set the sensitivity to 1 V (rms) and DR setting to LOW.
Set the time constant to 100 ms.
Set the attenuation slope to 24 dB/oct (SYNC OFF).
Set measurement parameter DATA1 to X, DATA2 to Y, DATA3 to X and DATA4 to Y.
Turn on the offset function for both X and Y.
- Measurement instrument settings : Set the DMM to DC voltage mode.
- Connections : Connect a shorted plug (or 50 Ω terminator) to connector A of the LI56xx.
Connect the LI56xx DATA OUT1 to 4 connectors to the DMM with a BNC cable.
- Measurement method : With the offset value set to +100%, 0% and -100%, read the measurement value on the DMM for each DATA OUT connector.
- Judgment (Pass Range) : Per the following table.

Measurement method

Judgment: Per the following table.

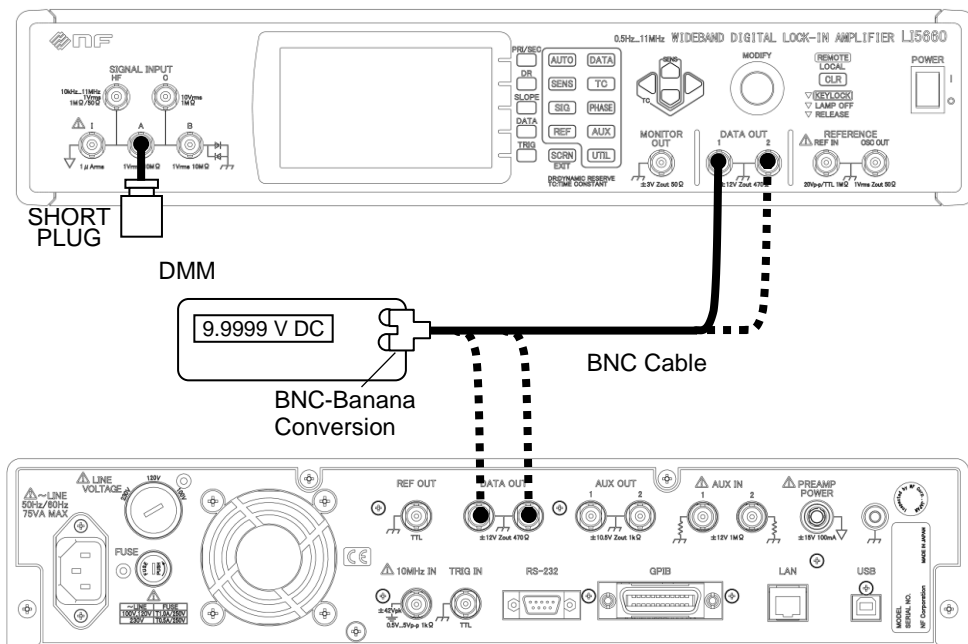

Judgment

Offset Value	DMM Reading Pass Range (± 10.040 V at $\pm 100\%$, ± 10 mV at 0%)			
	DATA1 (X)	DATA2 (Y)	DATA3 (X)	DATA4 (Y)
+100%	+ _ . _ _ _ V	+ _ . _ _ _ V	+ _ . _ _ _ V	+ _ . _ _ _ V
0%	_ . _ _ mV	_ . _ _ mV	_ . _ _ mV	_ . _ _ mV
-100%	- _ . _ _ _ V	- _ . _ _ _ V	- _ . _ _ _ V	- _ . _ _ _ V

8.6.6 Common Mode Rejection Ratio

- LI56xx settings : Use connector A-B for signal input.
Set the input coupling to AC.
Set the signal ground to FLOAT.
Set the line filter to THRU.
Use INT OSC (internal oscillator) as the reference signal source.
Set the amplitude to 1 V (rms).
Set the sensitivity to 200 μV (rms) and the DR setting to LOW.
Set the time constant to 100 ms.
Set the attenuation slope to 24 dB/oct (SYNC OFF).
Set measurement parameter DATA1 to R.
Frequency is per the following table.
- Measurement instrument settings : Only BNC cable and divider.
- Connections : Connect a BNC cable from one side of a divider at the LI56xx OSC OUT connector to connector A. Connect a BNC cable from the other side of the divider to connector B.
- Measurement method : At the frequencies in the following table, read the displayed DATA1 value.
- Judgment (Pass Range) : Per the following table.

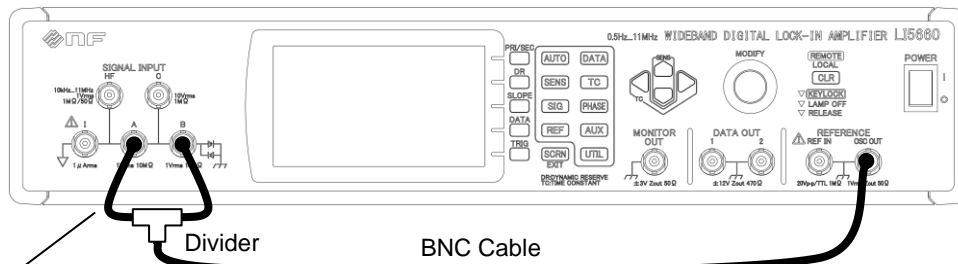

Two short BNC cables with the same characteristics

Judgment

Frequency Range	Time Constant	DATA1 (rms)	Pass Range
55 Hz	200 ms	. _ _ μV	< 10 μV
1 kHz	100 ms	. _ _ μV	< 10 μV

8.6.7 Input referred noise.

- LI56xx settings : Use connector A for signal input.
Set the input coupling to AC.
Set the signal ground to FLOAT.
Use INT OSC (internal oscillator) as the reference signal source.
Set the amplitude to 0V (rms).
Set measurement parameter DATA1 to NOISE.
Set sensitivity to $200 \text{ nV}/\sqrt{\text{Hz}}$ and DR to LOW.
Set the time constant to 100 ms.
Set the attenuation slope to 24 dB/oct (SYNC OFF).
Frequency is per the following table.
- Measurement instrument settings : Shorted plug
(if necessary, use an oscilloscope)
- Connections : Connect a shorted plug to connector A.
- Measurement method : Read the displayed DATA1 value.
(Note: If large fluctuations make reading difficult, connect an oscilloscope to LI56xx DATA OUT1. Set the time axis to 10 s/div or more and read the center value of the noise amplitude.)
- Judgment (Pass Range) : Per the following table.

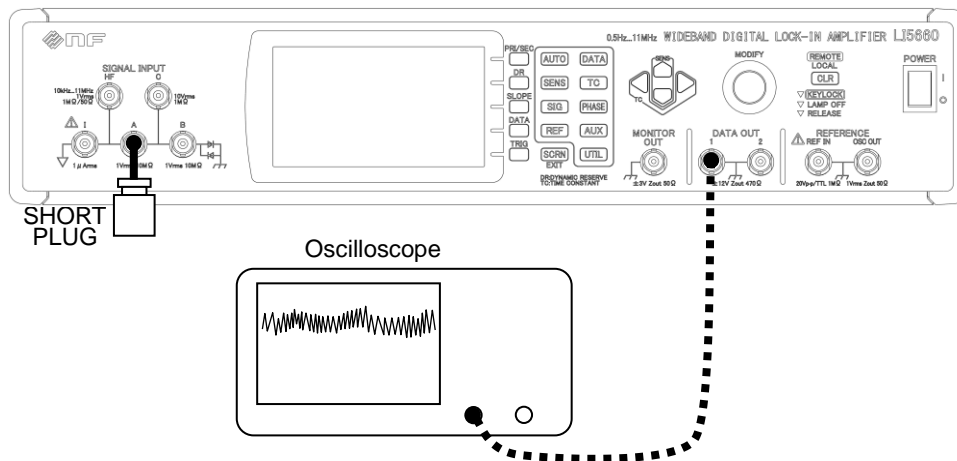

Judgment

NOISE	Pass Criteria*2
$_ _ \text{ nV}/\sqrt{\text{Hz}}$	$4.5 \text{ nV}/\sqrt{\text{Hz}}$

*2. Supplementary value. Not guaranteed. Frequency 1 kHz.

8.6.8 Phase Accuracy

1) Versus an external reference signal

- LI56xx settings : Use connector A for signal input.
 Set the input coupling to DC.
 Set the signal ground to FLOAT.
 Use REF IN (external reference signal) for the reference signal source.
 Select the SIN+ reference signal waveform.
 Set the sensitivity to 1 V (rms) and DR setting to LOW.
 Set the attenuation slope to 24 dB/oct (SYNC OFF).
 Set measurement parameter DATA2 to θ .
 Frequencies and time constants are as in the following table.
- Measurement instrument settings : Set the generator to sine wave.
- Connections : Connect a BNC cable from one side of a divider at the generator output connector to connector A. Connect a BNC cable from the other side of the divider to the REF IN connector.
- Measurement method : Set the following frequencies and time constants and read the displayed DATA2 value.
- Judgment (Pass Range) : Per the following table.

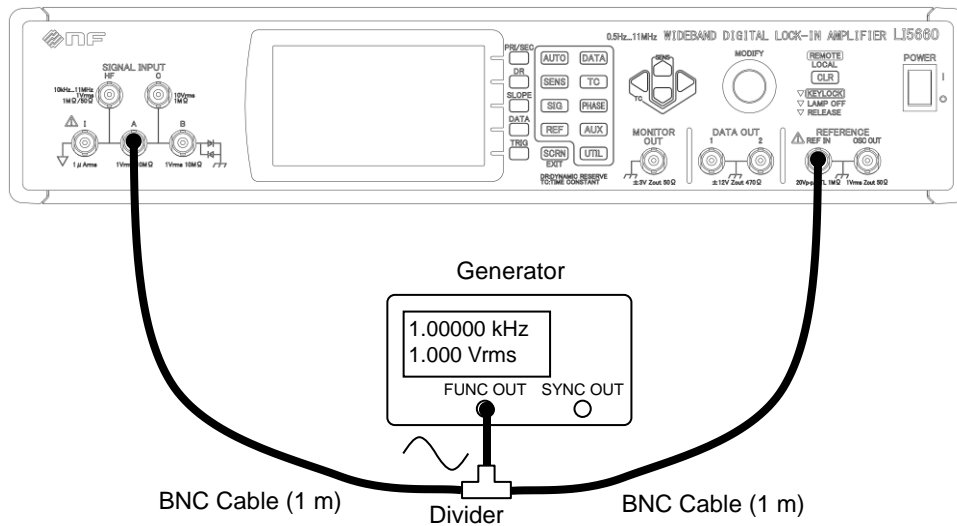

* Two short, equal-length BNC cables with the same characteristics.

Judgment

Frequency	Time Constant	θ	Pass Criteria* ²
10 Hz	1 s	---.---°	-1 to +1 °
1 kHz	100 ms	---.---°	-1 to +1 °
10 kHz	10 ms	---.---°	-1 to +1 °
100 kHz	10 ms	---.---°	-2 to +2 °
1 MHz	10 ms	---.---°	-5 to +5 °
3 MHz	10 ms	---.---°	-10 to +10 °

*2. Supplementary value. Not guaranteed.

Check that that the value is roughly within this range.

If too far off, there may be damage.

2) Versus the internal oscillator

- LI56xx settings : Change the following "1) Versus an external reference signal " settings.
Use INT OSC (internal oscillator) as the reference signal source.
Set the amplitude to 1 Vrms.
- Measurement instrument settings : Only BNC cable.
- Connections : Connect a BNC cable from the LI56xx OSC OUT connector to connector A.
- Measurement method : Set the following frequencies and time constants and read the displayed DATA2 value.
- Judgment (Pass Range) : Per the following table.

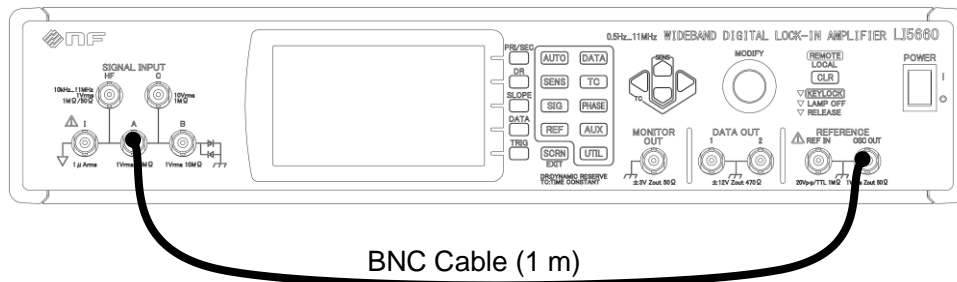

Judgment (same as " Versus an external reference signal ")

Frequency	Time Constant	θ	Pass Criteria* ³
10 Hz	1 s	---.---°	-1 to +1 °
1 kHz	10 ms	---.---°	-1 to +1 °
10 kHz	10 ms	---.---°	-1 to +1 °
100 kHz	10 ms	---.---°	-2 to +2 °
1 MHz	10 ms	---.---°	-5 to +5 °
3 MHz	10 ms	---.---°	-10 to +10 °

*3. Supplementary value. Not guaranteed.

8.6.9 Frequency Accuracy

- LI56xx settings : Use INT OSC (internal oscillator) as the reference signal source.
Set the frequency to 1 kHz and amplitude to 1 V (rms).
Open 10 MHz IN (external synchronous 10 MHz).
Signal input connectors, input coupling, signal ground, measurement parameters, sensitivity, DR setting, time constant and attenuation slope can be set arbitrarily.
- Measurement instrument settings : Use a frequency counter
- Connections : Connect the LI56xx OSC OUT connector to the frequency counter with a BNC cable.
- Measurement method : Read the measured value on the frequency counter.
- Judgment (Pass Range) : Per the following table.

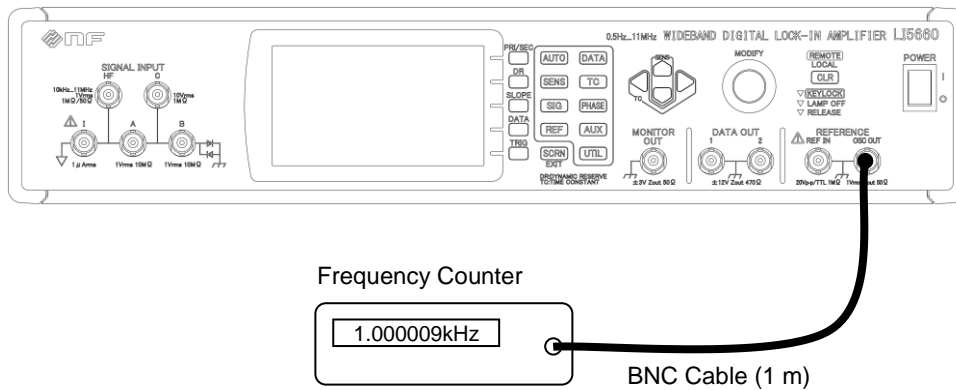

Judgment

Measured value	Pass Range
.. - - - - - kHz	0.999960 to 1.000040 kHz

8.6.10 Amplitude Accuracy of Internal Oscillator Sine Wave Output

- LI56xx settings : Use INT OSC (internal oscillator) as the reference signal source. Signal input connectors, input coupling, signal ground, measurement parameters, sensitivity, DR setting, time constant and attenuation slope can be set arbitrarily. Frequency, amplitude and amplitude range are per the following table.
- Measurement instrument settings : Set the DMM for 1 kHz in AC voltage mode. For 100 kHz to 3 MHz, use the RMS Voltmeter.
- Connections : Connect the LI 56xx OSC OUT connector to the DMM (or RMS Voltmeter) with a BNC cable.
- Measurement method : Read the measurement values on the DMM (or RMS Voltmeter).
- Judgment (Pass Range) : Per the following table.

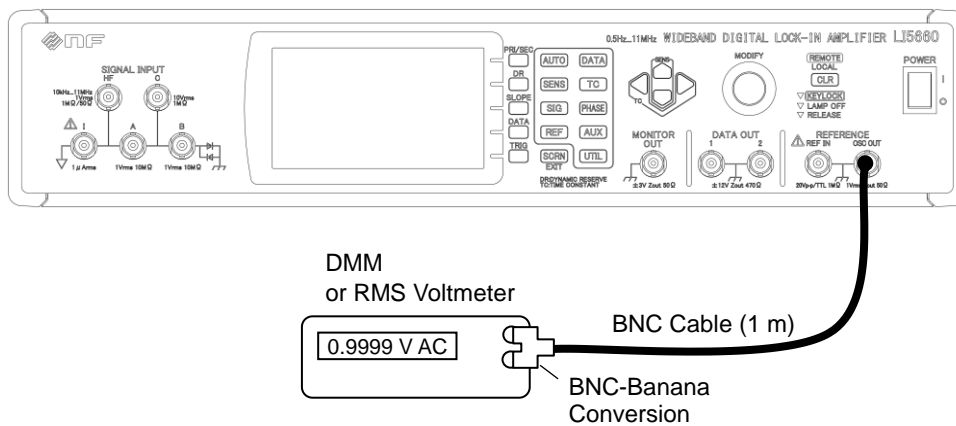

Judgment

Amplitude Range (rms)	Amplitude Setting (rms)	Pass Range Voltmeter Reading (rms)		
		1 kHz	1 MHz	3 MHz
1 V	1 V	0.979 to 1.021 _ . _ _ _ V	0.958 to 1.042 _ . _ _ _ V	0.925 to 1.075 _ . _ _ _ V
1 V	100 mV	97.0 to 103.0 _ _ _ . _ _ mV	94.0 to 106.0 _ _ _ . _ _ mV	88.0 to 112.0 _ _ _ . _ _ mV
100 mV	100 mV	97.0 to 103.0 _ _ _ . _ _ mV	94.0 to 106.0 _ _ _ . _ _ mV	88.0 to 112.0 _ _ _ . _ _ mV
10 mV	10 mV	8.80 to 11.20 _ . _ _ _ mV	4.30 to 12.40 _ . _ _ _ mV	4.30 to 15.70 _ . _ _ _ mV

8.6.11 AUX IN DC Voltage Measurement Accuracy

- LI56xx settings : Set measurement parameter DATA1 to AUX1, and DATA2 to AUX2. Reference signal source, frequency, amplitude, signal input connectors, input coupling, signal ground, sensitivity, DR setting, time constant and attenuation slope can be set arbitrarily. Set AUX OUT1 per following table.
- Measurement instrument settings : Set the DMM to DC voltage mode.
- Connections : Connect a BNC cable from one side of a divider at the LI56xx AUX OUT1 connector to AUX IN1 (or AUX IN2). Connect a BNC cable from the other side of the divider to the DMM.
- Measurement method : Read the measured value of the output voltage at AUX OUT1 on the DMM, and the displayed value of DATA1 (or DATA2). Also read the value when the shorting plug is connected to AUX IN1 (or AUX IN2)
- Judgment (Pass Range) : Per the following table.

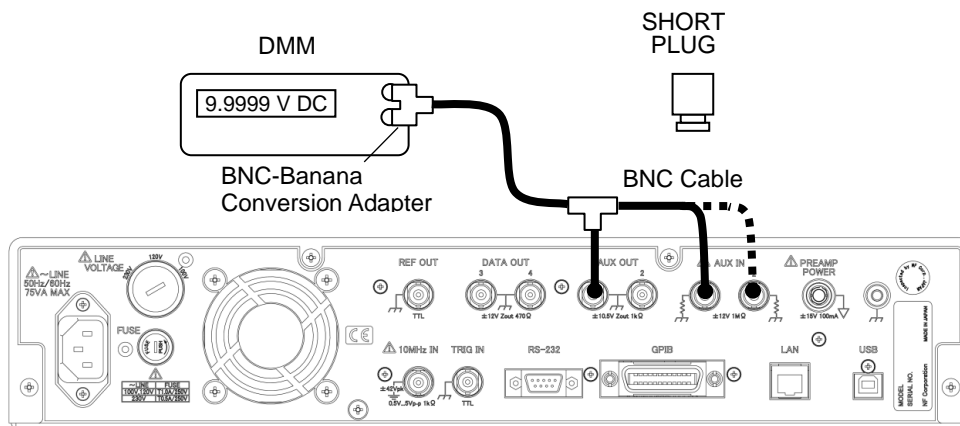

Judgment

AUX OUT 1	DMM reading: M	Pass Range	Measured value	
			AUX IN 1	AUX IN 2
+10 V	+ _ . _ _ V	$M \times 0.997 - 0.01 : + _ . _ _ _$ to $M \times 1.003 + 0.01 : + _ . _ _ _$	+ _ . _ _ V	+ _ . _ _ V
(short-circuited input)	/	- 10 mV to +10 mV	_ . _ _ mV	_ . _ _ mV
-10 V	- _ . _ _ V	$M \times 0.997 + 0.01 : - _ . _ _ _$ to $M \times 1.003 - 0.01 : - _ . _ _ _$	- _ . _ _ V	- _ . _ _ V

8.6.12 AUX OUT RMS Voltage Accuracy

- LI56xx settings : Measurement parameters, reference signal source, frequency, amplitude, signal input connectors, input coupling, signal ground, sensitivity, DR setting, time constant and attenuation slope can be set arbitrarily.
Set AUX OUT1 and AUX OUT2 per following table.
- Measurement instrument settings : Set the DMM to DC voltage mode.
- Connections : Connect the LI56xx AUX OUT1 (or AUX OUT2) connector to the DMM with a BNC cable.
- Measurement method : Read the measured value of the output voltage at AUX OUT1 (or AUX OUT2) on the DMM.
- Judgment (Pass Range) : Per the following table.

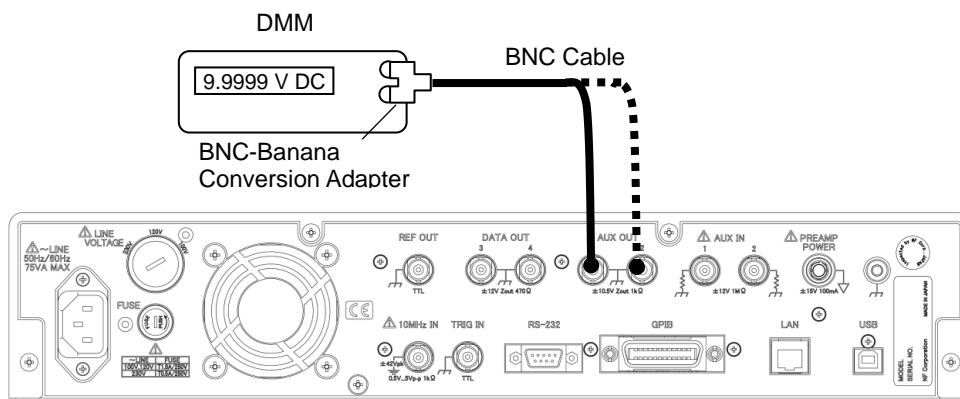

Judgment

AUX OUT 1, 2 Voltage Setting	Pass Range DMM reading	
	AUX OUT 1	AUX OUT 2
+10 V	+9.96 to +10.04 + _ . _ _ V	+9.96 to +10.04 + _ . _ _ V
0 V	-10 to +10 _ . _ mV	-10 to +10 _ . _ mV
-10 V	-10.04 to -9.96 - _ . _ _ V	-10.04 to -9.96 - _ . _ _ V

8.7 Calibration

If the performance test results do not satisfy the specifications, NF Corporation will perform adjustment or calibration to restore the original performance.

If calibration is required, contact NF Corporation or one of our agents.

After warranty expiration, we provide adjustment and calibration for a fee.

8.8 Maintenance Information

The {Maintenance Information Screen} shown below is for maintenance tasks such as repairs and calibration. It is not applicable to user operations.

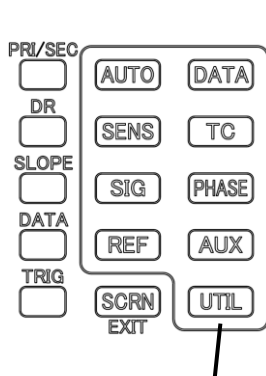

UTIL key
(Operation Screen Selection Keys)

To view the {Maintenance Information Screen}, press the **UTIL** key to display to the Utility Screen.

Pressing the [SYSTEM>] soft key switches to the {System Setting Screen}.

Pressing the [SERVICE>] soft key displays the {Maintenance Information Screen}.

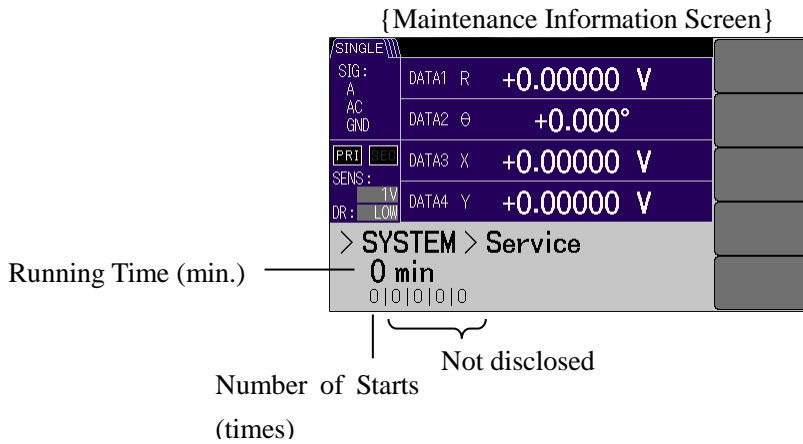

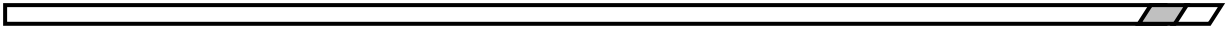

(Blank)

9. Specification

9.1 Measured signal system	9-2
9.2 Phase Sensitive Detector Section.....	9-7
9.3 Reference Signal System.....	9-11
9.4 Arithmetic Processing	9-15
9.5 Measured Value Output and Display Section	9-17
9.6 Monitor Output.....	9-18
9.7 Auxiliary Input (DC Voltage Measurement).....	9-19
9.8 Auxiliary Output (DC Voltage Output)	9-19
9.9 Automatic Setting Items	9-19
9.10 Data Memory	9-20
9.11 Remote Control Interface	9-21
9.12 General Specifications	9-22
9.13 External Dimensions Diagram.....	9-23

Nominal, Typical, Supplement and Approximate values

These values show the supplemental data of this product and do not guarantee the performance.

9.1 Measured signal system

*1. The C and HF connectors are present only on the LI5660, and not on the LI5655.

Therefore, specifications regarding C and HF connectors apply only to the LI5660.

a) Voltage Measurement

Input connector BNC (Front panel A, B, C, *1 HF*1)

Use B for A-B (differential input).

Input type A, C*1, HF*1 single-end,
A-B differential

Frequency range

A, A-B, C*1 0.5 Hz to 3 MHz

HF*1 10 kHz to 11 MHz

Sensitivity

A, A-B 10 nV to 1 V f.s. (1-2-5 sequence)

C*1 1 mV to 10 V f.s. (1-2-5 sequence)

HF*1 1 mV to 1 V f.s. (1-2-5 sequence)

- 1-2-5 sequence in repeating progression

1, 2, 5, 10, 20, 50, 100, 200, 500, ...

Voltage accuracy

A, A-B $\pm 0.5\%$ (1 kHz, signal level ≥ 1 mV, 23 ± 5 °C)*2
 $\pm 2\%$ (1 kHz, signal level ≥ 1 μ V)*2
 $\pm 0.5\%$ (≤ 20 kHz, sensitivity 100 mV to 1 V at 23 ± 5 °C)*3
 $\pm 1\%$ (≤ 50 kHz, sensitivity 100 mV to 1 V)*3
 $\pm 2\%$ (≤ 100 kHz, sensitivity 100 mV to 1 V)*3
 $\pm 3\%$ (≤ 1 MHz, sensitivity 100 mV to 1 V)*3
 $\pm 5\%$ (≤ 3 MHz, sensitivity 100 mV to 1 V)*3

*2. with at least 30% full-scale signal (sensitivity), and dynamic reserve LOW

*3. with DC coupling, dynamic reserve LOW, and full-scale signal

For details about dynamic reserve,

☞ "9.2 Phase Sensitive Detector c) Dynamic Reserve (DR)"

C*1 $\pm 0.5\%$ (≤ 20 kHz)
 $\pm 1\%$ (≤ 50 kHz)
 $\pm 2\%$ (≤ 100 kHz)
 $\pm 3\%$ (≤ 1 MHz)
 $\pm 5\%$ (≤ 3 MHz)

with sensitivity 1 V to 10 V, full-scale signal, and dynamic reserve LOW

HF*¹ ±3 % (≤ 1 MHz, input impedance 1 MΩ)
 ±5 % (≤ 3 MHz, input impedance 1 MΩ)
 ±7 % (≤ 10 MHz, input impedance 50 Ω)
 ±14 % (≤ 11 MHz, input impedance 50 Ω)
 dynamic reserve LOW, sensitivity 100 mV to 1 V, and full-scale signal

Voltage accuracy temperature drift

A, A-B ± 100ppm / °C (supplementary value)
 f: 1 kHz, dynamic reserve LOW, A input, sensitivity 1V, signal level 100 % of
 full-scale sensitivity

Input impedance

A, B 10 MΩ (nominal value), 50 pF in parallel (supplementary value)
 C *¹ 1 MΩ (nominal value), 50 pF in parallel (supplementary value)
 HF *¹ 1 MΩ (nominal value), 50 pF in parallel (supplementary value)
 | 50 Ω (nominal value)

Input referred noise.

A, A-B 4.5 nV/√ Hz (supplementary value)
 dynamic reserve LOW, sensitivity 1 mV or less, frequency 1 kHz, input short

Common-mode rejection ratio

A-B at least 100dB
 AC coupling, 50 Hz to 1 kHz, signal source impedance 0 Ω, dynamic reserve
 LOW, and sensitivity 20 mV or less (or MED and 2 mV or less)

Harmonic distortion

A, A-B -80 dBc or less (10 Hz to 5 kHz, 2-3rd order harmonics, each order)
 dynamic reserve LOW, sensitivity 1 V, signal level 30 % of full-scale sensitivity.

Maximum input voltage (linear operating range)

A, B, A-B ± 3 V (each connector voltage and differential voltage at DC coupling)
 dynamic reserve HIGH, sensitivity 1 V
 C *¹ ± 30 V
 dynamic reserve HIGH, sensitivity 10 V
 HF *¹ ± 3 V
 dynamic reserve HIGH, sensitivity 1 V

Nondestructive maximum input voltage

A, B	AC coupling: 10 Vrms, sine wave, ± 42 V DC DC coupling: ± 14 V When a signal is over-range, the internal signal protection circuit temporarily disconnects the input connector.
C*1	± 42 V
HF*1	± 5 V

b) Current measurement

Input connector	BNC (front panel I)
Input type	Single-end
Frequency range	0.5 Hz to maximum values shown in the table below (nominal values, 3dB reduction frequency)

Cs*4	Conversion Gain	
	1 M (10 ⁶) [V/A]	100 M (10 ⁸) [V/A]
None	1 MHz	10 kHz
150 pF	1 MHz	10 kHz
1 nF	150 kHz	1.5 kHz

*4. Signal Source + Connection Cable Capacitance

Sensitivity	100 fA to 1 μ A f.s. (with 1 M V/A conversion gain) 10 fA to 10 nA f.s. (with 100 M V/A conversion gain) Both in 1-2-5 sequence
Current accuracy	± 1 % at 23 ± 5 °C, dynamic reserve LOW, sensitivity 1 μ A (1 M V/A conversion gain at 1 kHz) as well as sensitivity 10 nA (100 M V/A conversion gain at 125 Hz), 30% or more of full-scale sensitivity signal Both are typical values
Current accuracy temperature drift	± 150 ppm / °C dynamic reserve LOW, supplementary value for (conversion gain 1 M [V/A], 1 kHz) and (conversion gain 100 M [V/A], 125Hz)
Input referred noise	150 fA/ $\sqrt{\text{Hz}}$ (1 M V/A conversion gain at 1 kHz) 15 fA/ $\sqrt{\text{Hz}}$ (100 M V/A conversion gain at 125 Hz) Both are supplementary values
Input impedance	1 k Ω (1 M V/A conversion gain) 100 k Ω (100 M V/A conversion gain) Both are supplementary values

Maximum input current (linear operating range)

$\pm 3 \mu\text{A}$

With DC coupling, dynamic reserve HIGH, conversion gain 1 M [V/A] ,
sensitivity 1 μA

Non-destructive maximum input current

$\pm 10 \text{ mA}$

c) Noise density measurement

Sensitivity	Voltage	20 nV/ $\sqrt{\text{Hz}}$ to 1 V/ $\sqrt{\text{Hz}}$ (at inputs A, A-B)
		1 mV/ $\sqrt{\text{Hz}}$ to 10 V/ $\sqrt{\text{Hz}}$ (at input C ^{*1})
		1 mV/ $\sqrt{\text{Hz}}$ to 1 V/ $\sqrt{\text{Hz}}$ (at HF input ^{*1})
	Current	1 pA/ $\sqrt{\text{Hz}}$ to 1 $\mu\text{A}/\sqrt{\text{Hz}}$ (with 1 M V/A at input I)
		100 fA/ $\sqrt{\text{Hz}}$ to 10 nA/ $\sqrt{\text{Hz}}$ (with 100 M V/A at input I)
All in 1-2-5 sequence		

d) Input Coupling^{*1}

A, A-B:	AC/DC switching AC coupling with two-stage cascaded 1st order HPF HPF fc: 0.1Hz (nominal value),
I:	AC/DC switching, After converting the voltage
C ^{*1} :	DC (Always automatically cancel DC component)
HF ^{*1} :	AC fc: 1 kHz (nominal value), when input impedance is 50 Ω , the AC-couple stage is positioned after the 50 Ω termination one.

e) Input Ground

FLOAT / CONNECT (to chassis) switching
Withstand voltage : $\pm 1 \text{ Vpk max. (DC+AC)}$
Impedance to chassis (nominal value) : 10 k Ω (float), 11 Ω (connected to the chassis)

Remarks: The outer contacts of input connectors A, B, C^{*1}, HF^{*1}, I and the preamp power supply output (PREAMP POWER) ground line (0 V) are connected together internally.
Other input and output signal grounds that are not specified otherwise are connected to the chassis.

f) Line Filter

rejection frequency (fundamental)

50 Hz | 60 Hz select

Function

- Through
- Fundamental rejection (50 Hz or 60 Hz)
- 2 nd order harmonics rejection (100 Hz or 120 Hz)
- Both of Fundamental and 2 nd order harmonics rejection

Attention

20 dB or more (at f_0)

Restrictions

When using the input C^{*1} and HF^{*1} , Line filter is disable regardless of Line filter settings.

9.2 Phase Sensitive Detector Section

*1. The C and HF connectors are present only on the LI5660, and not on the LI5655.

Therefore, specifications regarding C and HF connectors apply only to the LI5660.

a) Phase Sensitive Detector (PSD)

2 phase ($R\cos \theta$, $R\sin \theta$), Dual PSD (primary PSD, secondary PSD).

Settings Items	Primary PSD	Secondary PSD
Sensitivity	Individual	Individual ^{*2}
Time Constant	Individual	Individual
Phase	Individual	Individual
XY Offset	Individual	Individual
Dynamic Reserve	Individual	Common with Primary PSD

*2. The sensitivity of the secondary PSD is limited by that of the primary PSD.

The sensitivity setting of the secondary PSD can be higher than that of the primary PSD, but cannot be lower. (For example, if primary PSD sensitivity is 1 mV, secondary PSD sensitivity can be set to 500 μ V, but not 2 mV.)

b) Detection Modes

Detection Mode	Measurement Frequency	
	primary PSD	secondary PSD
SINGLE ^{*3}	fundamental / fractional harmonic	none
DUAL1 ^{*4}	fundamental / fractional harmonic	fundamental /harmonic
DUAL2 ^{*5}	primary frequency	secondary frequency
CASCADE ^{*6}	primary frequency	secondary frequency

*3. 2-phase detection is at one frequency.

*4. The fundamental and a harmonic component of one input signal are measured simultaneously.

*5. Two independent frequency components (primary and secondary) of one input signal are measured simultaneously.

*6. The Secondary PSD is connected in cascade with the primary PSD, so after a signal is detected by the Primary PSD, it is further detected by the secondary PSD.

For details about the primary and secondary frequencies,

☞ "9.3 Reference Signal System" c) Internal Oscillators".

c) Dynamic Reserve (DR)

Effective Range	100 dB or more (supplementary value)
Settings	LOW / MEDIUM / HIGH 3-point switching

The actual value changes according to sensitivity and dynamic reserve settings, frequency difference between signals and noise, and time constant filter setting. The following table shows nominal values at frequencies for which noise is sufficiently attenuated by the time constant filter. Settings that exceed 100 dB require a large time constant, and drift and measurement value errors may become larger.

- dynamic reserve (DR) definition

$$\text{DR} = \text{Maximum acceptable noise level} \div \text{Sensitivity (full-scale signal)}$$

Inputs: A, A-B, I

DR Setting			LOW		MEDIUM		HIGH	
Sensitivity (each input)			AC Gain dB	DR dB	AC Gain dB	DR dB	AC Gain dB	DR dB
I (1M)	I (100M)	A, A-B						
1 μ A	10 nA	1 V	0	6	0	6	0	6
500 nA	5 nA	500 mV	6	6	0	12	0	12
200 nA	2 nA	200 mV	14	6	6	14	0	20
100 nA	1 nA	100 mV	20	6	12	14	0	26
50 nA	500 pA	50 mV	26	6	14	18	0	32
20 nA	200 pA	20 mV	34	6	20	20	0	40
10 nA	100 pA	10 mV	40	6	26	20	0	46
5 nA	50 pA	5 mV	42	10	32	20	0	52
2 nA	20 pA	2 mV	48	12	32	28	0	60
1 nA	10 pA	1 mV	54	12	32	34	0	66
500 pA	5 pA	500 μ V	56	16	32	40	0	72
200 pA	2 pA	200 μ V	56	24	32	48	0	80
100 pA	1 pA	100 μ V	56	30	32	54	0	86
50 pA	500 fA	50 μ V	56	36	32	60	0	92
20 pA	200 fA	20 μ V	56	44	32	68	0	100
10 pA	100 fA	10 μ V	56	50	32	74	0	106
5 pA	50 fA	5 μ V	56	56	32	80	0	112
2 pA	20 fA	2 μ V	56	64	32	88	0	120
1 pA	10 fA	1 μ V	56	70	32	94	0	126
500 fA	- - -	500 nV	56	76	32	100	0	132
200 fA	- - -	200 nV	56	84	32	108	0	140
100 fA	- - -	100 nV	56	90	32	114	0	146
- - -	- - -	50 nV	56	96	32	120	0	152
- - -	- - -	20 nV	56	104	32	128	0	160
- - -	- - -	10 nV	56	110	32	134	0	166

AC Gain: Gain ahead of the phase sensitive detector (PSD)

(common to primary and secondary PSDs)

$$\text{Gain dB} = 20 \times \log_{10} (\text{linear gain}) \text{ dB}$$

$$\text{Example: } 10 \text{ times} \rightarrow 20 \times \log_{10} 10 = 20 \text{ dB}$$

Input: C*¹

DR Setting	LOW		MEDIUM		HIGH	
Sensitivity (Input C)	AC Gain dB	DR dB	AC Gain dB	DR dB	AC Gain dB	DR dB
10 V	0	6	0	6	0	6
5 V	6	6	0	12	0	12
2 V	14	6	6	14	0	20
1 V	14	12	6	20	0	26
500 mV	14	18	6	26	0	32
200 mV	14	26	6	34	0	40
100 mV	14	32	6	40	0	46
50 mV	14	38	6	46	0	52
20 mV	14	46	6	54	0	60
10 mV	14	52	6	60	0	66
5 mV	14	58	6	66	0	72
2 mV	14	66	6	74	0	80
1 mV	14	72	6	80	0	86

Input: HF*¹

DR Setting	LOW		MEDIUM		HIGH	
Sensitivity (Input HF)	AC Gain dB	DR dB	AC Gain dB	DR dB	AC Gain dB	DR dB
1 V	0	6	0	6	0	6
500 mV	6	6	0	12	0	12
200 mV	14	6	6	14	0	20
100 mV	20	6	6	20	0	26
50 mV	20	12	6	26	0	32
20 mV	20	20	6	34	0	40
10 mV	20	26	6	40	0	46
5 mV	20	32	6	46	0	52
2 mV	20	40	6	54	0	60
1 mV	20	46	6	60	0	66

Secondary PSD dynamic reserve includes the sensitivity ratio of the primary PSD's dynamic reserve.

secondary PSD DR = primary PSD DR + $20 \times \log_{10}$ (primary PSD sensitivity ÷ secondary PSD sensitivity) dB

Ex.) Input A, DR set to HIGH, primary PSD sensitivity 2 mV (DR value: 60 dB),

When secondary PSD sensitivity is 1 mV

$$\text{secondary PSD DR} = 60 \text{ dB} + 20 \times \log_{10} (2 \text{ mV} \div 1 \text{ mV}) \text{ dB} = 66 \text{ dB}$$

d) Time Constant Filter

Time constant	1 μ s to 50 ks (1-2-5 sequence)
Attenuation slope	6, 12, 18, 24 dB/oct
Synchronous filter	on/off

- About the Time Constant Filter

A cascaded first-order low-pass filter suppresses noise and ripple associated with phase sensitive detection.

This digital low-pass filter exhibits the same exponential response as an analog filter.

The time constant setting determines the response time of the first-order low-pass filter, and the attenuator slope is determined by the filter cascade (6 dB/oct per step).

The higher each setting, the greater the noise and ripple rejection ratio.

The following types of synchronous filter are available.

- About the Synchronous Filter

This is an integer-period moving-average filter.

Ripple caused by detection is greatly reduced, and the output is nearly settled in the averaging interval (integer period), so the time constant can be reduced (to obtain faster response).

However, at higher signal frequencies, ripple suppression may be insufficient.

e) Others

Phase noise	0.001 $^{\circ}$ rms (at 1 kHz, 18 dB/oct or greater attenuation slope)
	0.003 $^{\circ}$ rms (at 100 kHz, 12 dB/oct or greater attenuation slope)
	0.01 $^{\circ}$ rms (at 3 MHz, 12 dB/oct or greater attenuation slope)
	Supplementary value; reference signal is external sine wave 1Vrms, time constant 100ms, synchronization filter off

Phase temperature drift	± 0.01 $^{\circ}$ /C (from 100 Hz to 10 kHz)
	± 0.03 $^{\circ}$ /C (from 10 kHz to 100 kHz)
	± 0.2 $^{\circ}$ /C (from 100 kHz to 3 MHz)
	Supplementary value when input signal (A connector) and external reference signal (REF IN connector) are both Sine wave 1Vrms.

9.3 Reference Signal System

*1. The C and HF connections are present only on the LI5660, and not on the LI5655.
Therefore, specifications regarding C and HF connectors apply only to the LI5660.

a) Reference signal source

REN IN external reference signal*2
INT OSC interenal oscillator
SIGNAL measured signal*3

In SIGNAL, the reference signal is so synchronized with an input signal that the phase measurement value becomes zero.

*2 : The external reference signal is used as the primary PSD's reference frequency at SINGLE, DUAL1, and DUAL2, and is used as the secondary one at CASCADE.

*3 : This mode cannot be used when input HF is selected.

b) External reference signal

Waveform SIN POS The waveform crosses the threshold level only twice per period. The negative to positive crossing of the mean value is established as 0°.

 TTL POS The square wave crosses the threshold level only twice per period. The rising edge is 0°.

 TTL NEG The square wave crosses the threshold level only twice per period. The falling edge is 0°.

Input connector BNC (front panel REF IN)

Input impedance 1 MΩ (nominal value), 100 pF in parallel (supplementary value)

Input voltage range SIN 0.3 to 20 V_{p-p} (sine wave)

 TTL 0 to 5 V, High 2.6 V or more, Low 0.8 V or less (square wave)

Pulse width (square wave) 40 ns or more (both high and low levels)

Nondestructive maximum input voltage ±15 V

Synchronization frequency range per following table

Signal Input	Detection Mode	External Reference Signal Waveform	Synchronous Frequency Range
A A-B C *1 I	SINGLE DUAL1 DUAL2 CASCADE	SIN POS TTL POS TTL NEG	0.3 Hz to 3.2 MHz
HF *1	SINGLE DUAL1 DUAL2	TTL POS TTL NEG	8 kHz to 11.5 MHz
	CASCADE	SIN POS TTL POS TTL NEG	0.3 Hz to 3.2 MHz

Synchronization time 2 periods + 50 ms (supplementary value)
 Frequency display resolution
 6 digits (to 0.1 mHz below 100 Hz)
 Frequency measurement accuracy
 ±(40 ppm + 1 count)

c) Internal Oscillator*1

Frequency (primary and secondary)
 setting range 0.3 Hz to 11.5 MHz
 For A, A-B, C*1, and I inputs, 0.3 Hz to 3.2 MHz
 with HF*1 input, 8 kHz to 11.5 MHz
 Resolution 6 digits (to 0.1 mHz below 100 Hz)
 Accuracy ±40 ppm
 For numerical value settings, frequency is stable immediately after setting.

- About primary and secondary frequencies
 Two distinct frequencies are generated for DUAL2 and CASCADE detection modes. The primary frequency is that of the internal oscillator connected to the primary PSD. The secondary frequency is that of the internal oscillator connected to the secondary PSD.

Reference frequency source

Internal/external switching (external 10 MHz sync function)

External reference frequency

Input connector BNC (Rear panel 10MHz IN)
 Frequency range 10 MHz ±0.2%
 Waveform Sine or square wave (45 to 55% duty cycle)
 Signal level 0.5 Vp-p to 5 Vp-p
 Non-destructive maximum input voltage
 10 Vp-p
 Input impedance 1 kΩ (nominal value)
 Input coupling AC
 Withstand voltage (Allowed voltage to ground)
 ±42 Vpeak max (DC+AC)

- About the External 10 MHz synchronization Function
 This 10 MHz reference frequency for frequency synthesis is provided from an external oscillator, and can be used to synchronize with the reference frequency. Therefore, even if no external reference signal (REF IN) is available, synchronization is available by numerical frequency setting of the internal oscillator.

Sine wave output

Output connector BNC (front panel OSC OUT)
 Frequency primary frequency (with detection mode SINGLE, DUAL1)
 primary frequency or secondary frequency (With detection mode DUAL2, CASCADE, can be selected)

Amplitude Per following table

Range	10 mV	100 mV	1V
Extent	0 to 10.00 mVrms	0 to 100.0 mVrms	0 to 1.000 Vrms
Resolution	0.01 mVrms	0.1 mVrms	0.001 Vrms

Amplitude accuracy

- $\pm(2 \% \text{ of setting} + 1 \text{ mV}) \leq 20 \text{ kHz}$
- $\pm(3 \% \text{ of setting} + 1 \text{ mV}) \leq 100 \text{ kHz}$
- $\pm(4 \% \text{ of setting} + 2 \text{ mV}) \leq 1 \text{ MHz}$
- $\pm(7 \% \text{ of setting} + 5 \text{ mV}) \leq 3 \text{ MHz}$

When > 3.2 MHz, 0 Vrms regardless of the setting.

Maximum output current

$\pm 15 \text{ mA}$

Load: Resistor connected to signal ground. Following is the same.

Output impedance 50 Ω (nominal value)

Harmonic distortion -80 dBc or less (20 Hz to 5 kHz)*4
 -70 dBc or less (5 kHz to 100 kHz)*4
 -60 dBc or less (100 kHz to 1 MHz)*5
 -50 dBc or less (1 MHz to 3 MHz)*5

Output voltage setting 1Vrms

*4 : No load, supplementary value for each of 2nd to 5th order harmonic

*5 : 50 Ω load, supplementary value for each of 2nd and 3rd order harmonic

Square wave output

Output connector BNC (rear panel REF OUT)

Frequency Same as sine wave output

Signal level TTL (0 to 3.3 V nominal /no load), $\pm 8 \text{ mA max}$

Restrictions Above 3.2 MHz and with 0 Vrms sine amplitude, output is unstable (fixed at high or low level).

d) Harmonic measurement

detection mode SINGLE

The primary frequency to the PSD is n/m times of reference signal frequency.

n range (harmonic) 1 to 63

m range (sub harmonic) 1 to 63

detection mode DUAL1

The primary frequency to the primary PSD is n/m times of the reference signal frequency. And the secondary frequency to the secondary PSD is n times of the reference signal frequency.

n PRI range (harmonics number of primary PSD) 1 to 63

m PRI range (sub harmonics number of primary PSD) 1 to 63

n SEC range (harmonics number of secondary PSD) 1 to 63

Harmonics are measured under the following conditions.

Reference Signal Source	Fundamental frequency range	Harmonic frequency range
REF IN	Synchronization frequency range to external reference signal	Same as at left
INT OSC	Internal oscillator frequency setting range	Same as at left
SIGNAL	Synchronization frequency range to external reference signal	Regardless of n, m settings, always operates at n = 1 and m = 1

e) Phase Adjustment

Phase shift amount Range -180.000° to $+179.999^\circ$ Resolution 0.001°

f) Others

Orthogonality $\pm 0.001^\circ$ or better (supplementary value)Phase accuracy $\pm 1^\circ$ (DC coupling, ≤ 10 kHz) $\pm 2^\circ$ (DC coupling, ≤ 100 kHz) $\pm 5^\circ$ (DC coupling, ≤ 1 MHz) $\pm 10^\circ$ (DC coupling, ≤ 3 MHz)

Reference signal source = REF IN

Signal input connector A (sensitivity 1 V),

Supplementary value when input signal (A connector) and external reference signal (REF IN connector) are both Sine wave 1Vrms.

9.4 Arithmetic Processing

The following calculations are available for measurement values X, Y and R.

For measurement values X, Y and R, refer to "9.5 Measured Value Output and Display Section"

- a) Offset adjustment Control Enable/Disable
 X, Y: sensitivity of $\pm 105\%$ (resolution 0.001%)
 Both of primary PSD and secondary PSD can be set

- About Offset Adjustment

This function enables deduction of a certain amount from the detectors' X and Y outputs. Use it to cancel crosstalk components contained in the input. Also, by setting X and Y near zero, the following expansion capabilities can be used to improve the apparent sensitivity and resolution, enabling measurement of small changes.

b) Expansion

- EXPAND X, R: 1, 10, 100 (Ratio of X and R is common)
 Y: 1, 10, 100
 Primary PSD and secondary PSD can be set individual
 Apparent sensitivity (signal F. S.) is $1 / \text{EXPAND}$ magnification
 Unusable when normalize or ratio arithmetic processing is running.

c) Normalize

- Select from the following
- None
- % value = (measured value / standard value) $\times 100$
- dB value = $20 \times \log_{10} | \text{measurement values} / \text{standard values} |$
- % FS value = (measured value / sensitivity) $\times 100$
- When detection mode is SINGLE, DUAL1, DUAL2,
 the above measurement value = primary PSD output (X or R)
- When detection mode is CASCADE,
 the above measurement value = secondary PSD output (X or R)
- Standard value range
- : voltage 1nV to 10V
- : current 1fA to 1 μ A
- : resolution 6-digit
- Unusable when EXPAND or Ratio arithmetic processing is running.

d) Ratio

Select from the following

- None
- ratio = $K \times A \div B$

K: range 0.1 to 10 (resolution 0.00001)

A, B: Select from a combination of the below

A (measured value)	B (standard value)	detection mode
primary PSD output (X, Y, R) / sensitivity	AUX IN 1 measured value / 10 V	SINGLE DUAL1 DUAL2
primary PSD output (X, Y, R) / sensitivity	secondary PSD X output / sensitivity	DUAL1 DUAL2
secondary PSD output (X, Y, R) / sensitivity	AUX IN 1 measured value / 10 V	CASCADE

Maximum update rate of B is about 10 k samples/s.

When executing expansion or normalizing or ratio arithmetic processing cannot be performed.

- About the Ratio

This is the ratio of measured value A to standard value B. Determining the ratio enables canceling out characteristic variation of the parts common to the measurement and standard systems (signal source, path and sensor).

For a usage example, see "1.2 Applications" ■ Application Examples Taking Advantage of the Feature of the LI5655 / LI5660

- b) Measurement of Light Transmission and Absorption, and Suppression of illuminant Fluctuation

9.5 Measured Value Output and Display Section

a) Parameter

Select from the following.

Output/Display	Detection Mode	
	SINGLE	DUAL1 DUAL2, CASCADE
DATA1	X, R, AUX IN 1, NOISE	$X_p, R_p, Y_p, \theta_p, X_s, R_s, \text{AUX IN 1, NOISE}$
DATA2	Y, θ , AUX IN 1, AUX IN 2	$Y_p, \theta_p, X_s, R_s, Y_s, \theta_s, \text{AUX IN 1, AUX IN 2}$
DATA3	X, R	$X_p, R_p, Y_p, \theta_p, X_s, R_s$
DATA4	Y, θ	$Y_p, \theta_p, X_s, R_s, Y_s, \theta_s$
Remarks: X, Y, R, θ suffix	n: Harmonic (At harmonic value settings, n as a suffix. Ex.: Xn)	p: primary PSD s: secondary PSD n: Harmonic (At harmonic value settings, n as a suffix. Ex.: Xpn)

X	In-phase component ($=R \cos \theta$)
Y	Quadrature component ($=R \sin \theta$)
R	Signal amplitude
θ	Signal phase
NOISE	Noise density (primary PSD only)
AUX IN 1	DC voltage (rear panel AUX IN 1)
AUX IN 2	DC voltage (rear panel AUX IN 2)

b) Analog output

Front Panel

Output connectors	BNC (DATA OUT 1, DATA OUT2: corresponding to DATA1 and 2)
Maximum update rate	312.5 k samples/s.

Rear Panel

Output connectors	BNC (DATA OUT 3, DATA OUT4: corresponding to DATA3 and 4)
Maximum update rate	1.5625 M samples/s.

Common Specifications

Full-scale voltage	± 10 V (bipolar signals), +10 V (unipolar signals)
Output voltage range	± 12 V (no-load)
Max output current	± 10 mA
Output impedance	470 Ω (nominal value)
Output voltage accuracy	$\pm(0.3 \% + 10 \text{ mV})$, versus measured value corresponding voltage Refer to the rightmost column of the table in part "e) Numerical display" for measured values corresponding voltage values.

c) Measurement screen display

Select the screen to display measurement values from the following.

Normal : show the measured values (DATA1, DATA2) and key settings

Large : enlarged display the measured values (DATA1, DATA2)

Fine : show the measured values (DATA1, DATA2, DATA3, DATA4) and advanced settings

d) Bar Graphs

On Normal and Large measurement screens, displays measured values as bar graphs as well as numerical values.

e) Numeric display

Parameter	Numeric display		Measurement value for the full scale voltage of the analog output
	Range	Resolution	
X, Y	Sensitivity / Expand (±120%)	6 digits, at full-scale sensitivity	±Sensitivity/EXPAND
R	Sensitivity/EXPAND (0 to 120%)	6 digits, at full-scale sensitivity	Sensitivity/EXPAND
θ	-180.000 to +179.999°	0.001°	± 180 °
NOISE (Noise density)	Sensitivity 0 to 120%	6 digits, at full-scale sensitivity	Sensitivity
AUX IN 1, 2	± 12 V	0.0001 V	± 10 V
Ratios	± 2.4	0.00001	± 2
Normalize %	± 240 %	0.001 %	± 200 %
Normalize% of f.s.	± 120 % of FS	0.001 % of FS	± 100 % of FS
Normalize dB	± 120 dB	0.001 dB	± 100 dB

9.6 Monitor Output

Monitor signal	Phase sensitive detector input signal
Output connector	BNC (front panel MONITOR OUT)
Maximum output voltage	±3 V (no-load)
	Output is approximately AC Gain times the input. For details of AC Gain, ☞ "9.2 Phase Phase Detection Section, c) Dynamic Reserve (DR)"
Max output current	±20 mA
Output impedance	50 Ω (nominal value)

9.7 Auxiliary Input (DC Voltage Measurement)

Number of channels	2
Input connectors	BNC (rear panel AUX IN 1, 2)
Maximum allowable input voltage (linear operating range)	± 12 V
Nondestructive maximum input voltage	± 42 V
Input impedance	1 M Ω (nominal value), 50 pF in parallel (supplementary value) When signal ground is at chassis potential.
Voltage measurement accuracy	$\pm (0.3 \% + 10 \text{ mV})$, when the input ground is equal to the chassis potential
Frequency bandwidth	Highest: 5 kHz (-3 dB) (supplementary value)
Sampling rate	Highest: 125 k samples/s
Floating characteristics	Signal Ground Maximum voltage to ground (non-destructive) $\pm 42\text{Vpk max. (DC+AC)}$ Ground impedance 1M Ω (nominal value) Signal Maximum voltage to ground (non-destructive) $\pm 42\text{Vpk max. (DC+AC)}$

9.8 Auxiliary Output (DC Voltage Output)

Number of channels	2
Output connectors	BNC (rear panel AUX OUT 1, 2)
Output voltage range	± 10.500 V (0.001 V resolution)
Maximum output current	± 5 mA
Output impedance	1 k Ω (nominal value)
Output voltage accuracy	$\pm (0.3\% + 10 \text{ mV})$, no-load

9.9 Automatic Setting Items

Item	Function
Measurement	Perform the following items "time constant", "sensitivity", "phase"
Time constant	Set the time constant and attenuation slope corresponding to the frequency of the reference signal.
Sensitivity	Set the sensitivity, and dynamic reserve according to the input signal.
Phase	Set the phase shift value as Y and phase output θ to a zero.
Offset	Set each offset value, X and Y outputs to a zero.

9.10 Data Memory

Record data For each sample data, select arbitrary up to five words from the following recorded data

Recording data	Words	Data Resolution
STATUS	1 Word	16 bits
DATA 1	1 Word	16 bits
DATA 2	1 Word	16 bits
DATA 3	1 Word	16 bits
DATA 4	1 Word	16 bits
Reference Signal Frequency	2 Words	32 bits

STATUS detects the following signals.

- UNLOCK (Unsynchronization)
- PROTECT (Input A or B overload)
- INPUT (pre PSD overload)
- OUTPUT (post PSD overload)
- AUX (AUX input overload)

Recording capacity	Buffers 1, 2	16 to 8192 samples
	Buffer 3	16 to 65536 sample (FIFO)
Trigger signal	Internal timer / External trigger / Remote control commands / Manual trigger 1 sample recorded when trigger signal is received	
Sampling interval	Internal timer Range : 1.92 μ s to 20 s, repeated at equal intervals, Resolution : 640ns, 6 digit max. External trigger / Remote control commands / Manual trigger Range : $\geq 2.6 \mu$ s arbitrary intervals, trigger jitter : 640 ns (nominal value)	
External trigger	Input connector	BNC (rear panel TRIG IN)
	Signal level	TTL (High 2.6 V or more, LOW 0.8 V or less)
	Minimum pulse width	500 ns (both high and low level)
	Effective edge	Falling
	Input impedance	10k Ω (nominal value)
	Nondestructive maximum input voltage	± 15 V
Trigger delay time	Range	0 to 100 s
	Resolution	640 ns, 6 digits max
	Data is recorded after the delay time has elapsed.	
Operation	By remote control. Can not operate from panel (only manual triggering is possible).	

9.11 Remote Control Interface

USB	USBTMC, USB 2.0 HiSpeed
RS-232	Baud rate 4800, 9600, 19200, 38400, 57600, 115200, 230400 bps Cable and controller characteristics can inhibit communication speeds over 19200 bps. Flow control None, Software (X-ON/X-OFF), Hardware (RTS/CTS)
GPIB	Compliance standards IEEE 488.1, IEEE 488.2
LAN	10BASE-T and 100BASE-TX, TCP/IP, LXI

9.12 General Specifications

- Display 4.3-inch WQVGA, color LCD
- Power supply AC 100 V ± 10 % / 120 V ± 10 % / 230 V+10 %, - 14 %
However 250 V or less
50 Hz / 60 Hz ± 2 Hz, power consumption 75 VA or less
Overvoltage category II

- Environmental conditions

Operating

- Temperature 0 to +40°C
- Humidity 5 to 85% RH, absolute humidity 1 to 25 g/m³, non-condensing
- Altitude 2000 m or less

Storage

- Temperature -10 to +50°C
- Humidity 5 to 95% RH, absolute humidity 1 to 29 g/m³, non-condensing

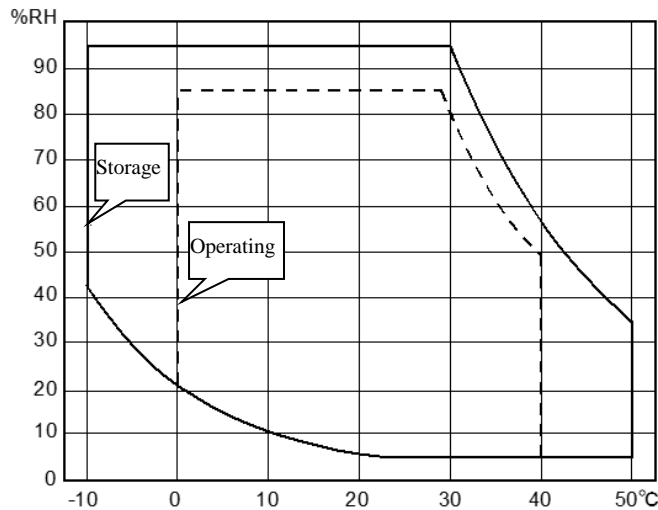

- Pollution degree 2 (indoor use)
- Warm-up time 30 minutes
- Setting memory 9 sets
- Resume Return to the last settings at power-on state
- Power output for preamp ± 15 V (nominal value)
100 mA max.(rear panel PREAMP POWER)
- Key-Lock Present (On, Off)
- Lamp control Present (On, Off)
Remarks: Cooling fan is always on. It cannot be turned off.
- RoHS Directive 2011/65/EU
- Safety and EMC EN 61010-1, EN 61010-2-030,
EN 61326-1, EN 61326-2-1
Remarks: Applies to products with CE marking displayed on the rear panel.
- External dimensions 430(W) × 88(H) × 400(D) mm, excluding protrusions
- Weight Approx. 7.5 kg, except for accessories

9.13 External Dimensions Diagram

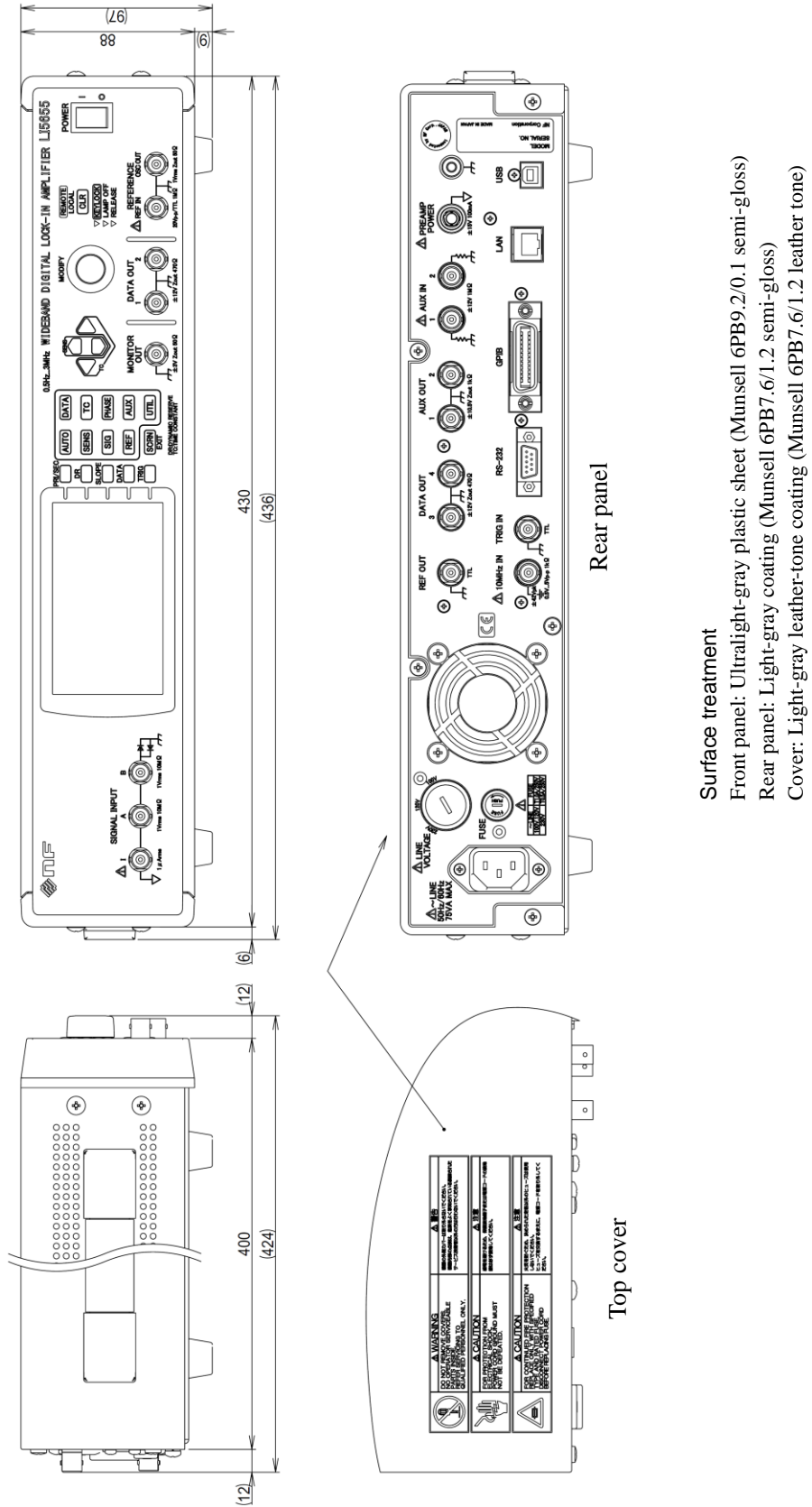

Figure 9-1 LI5655 External Dimensions Diagram

9.13 External Dimensions Diagram

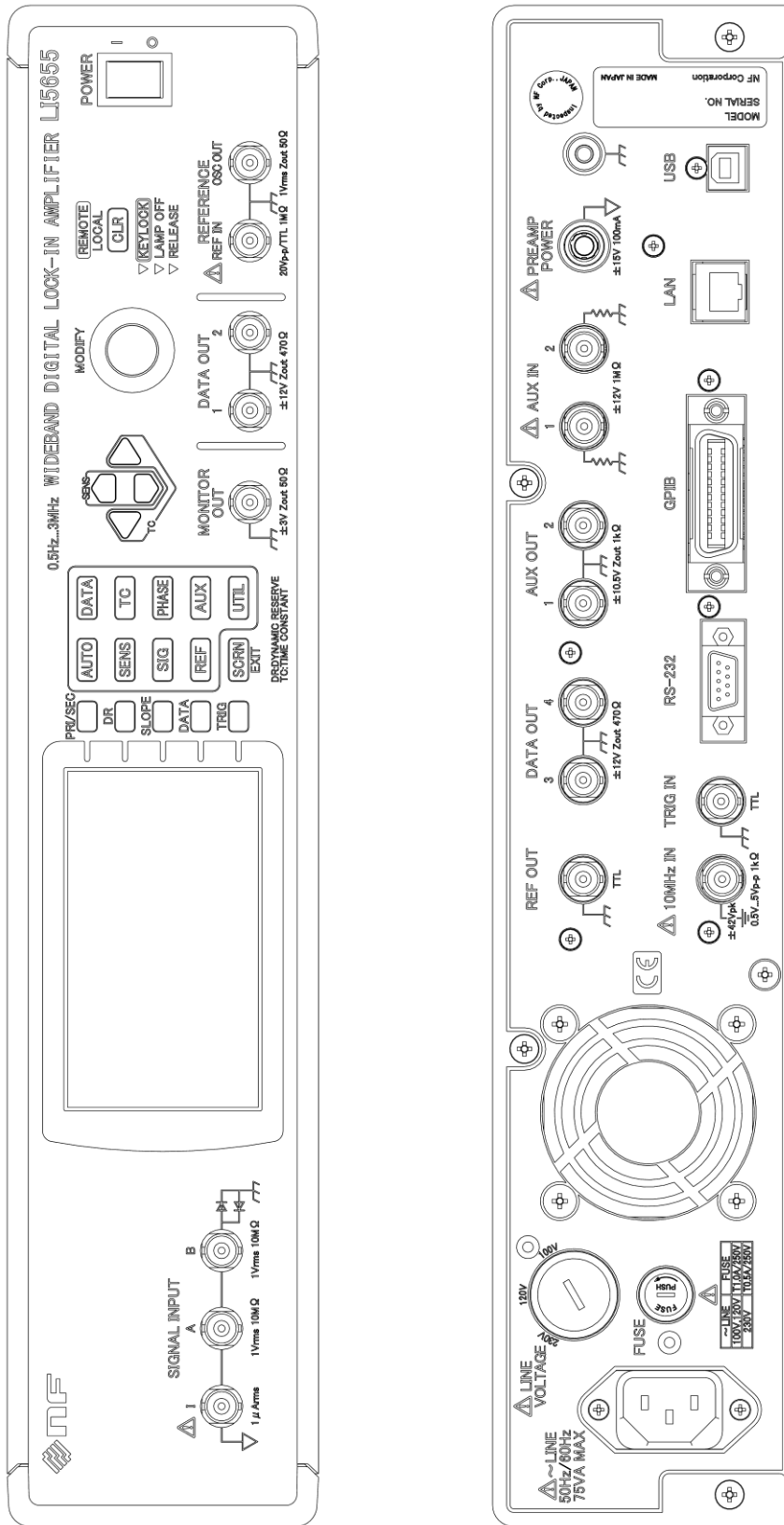

Figure 9-3 LI5655 Panel Diagram

9.13 External Dimensions Diagram

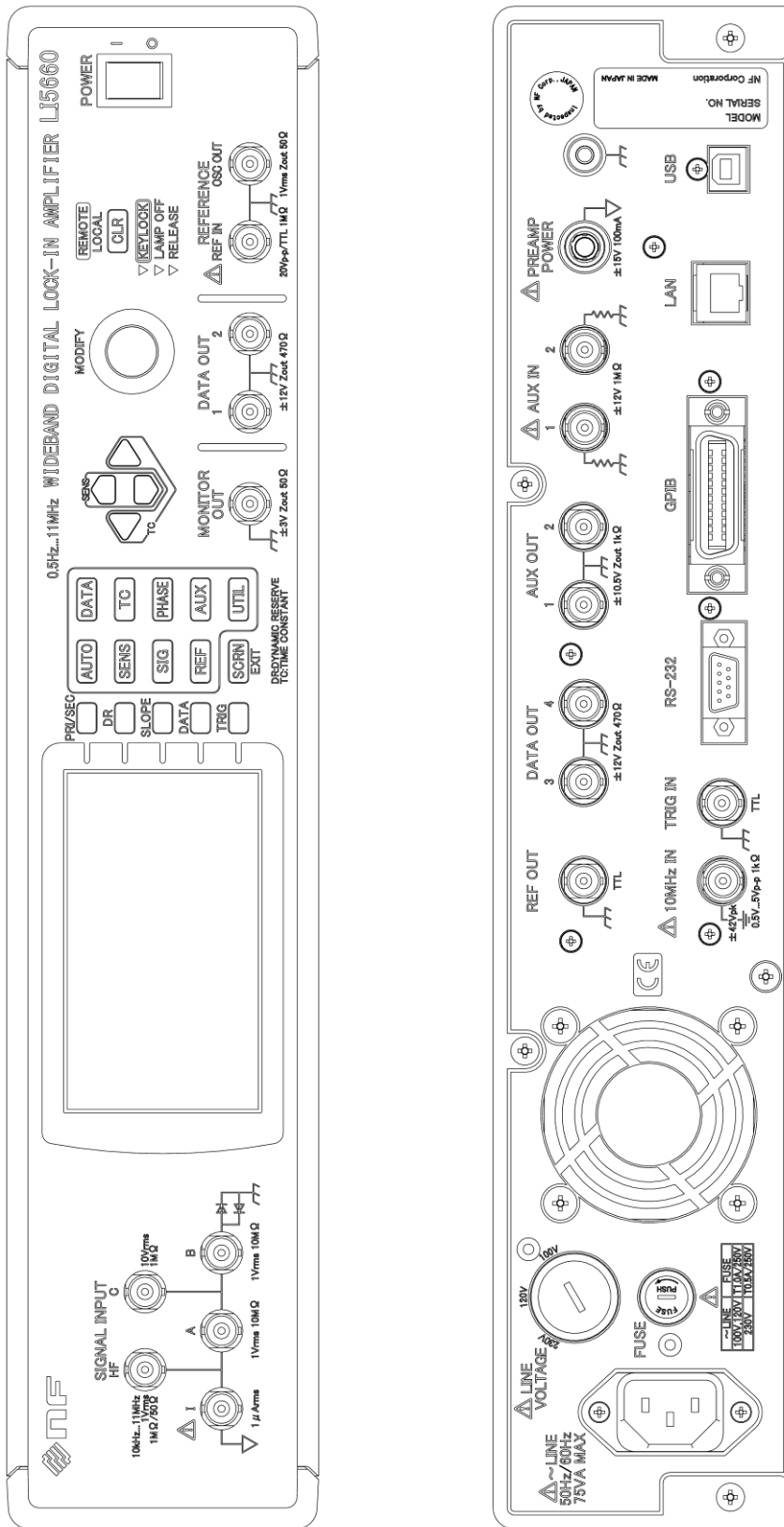

Figure 9-4 LI5660 Panel Diagram

Warranty

NF Corporation certifies that this product was thoroughly tested and inspected and found to meet its published specifications when it was shipped from our factory.

All **NF** products are warranted against defects in materials and workmanship for a period of one year from the date of shipment. During the warranty period, **NF** will repair the defective product without any charge for the parts and labor. For repair service under warranty, the product must be returned to either **NF** or an agent designated by **NF**. Purchaser shall prepay shipping charge, duties and taxes for the product to either **NF** or the agent from another country, and shipping charge for the return of the product to purchaser shall be paid by **NF** side.

This warranty shall not apply to any defect, failure or damage caused by a) improper use; b) improper or inadequate maintenance and care; or c) modification by purchaser or personnel other than **NF** representatives.

Request for Repair

When a failure occurred and the product was found to be defective or you have any uncertainty, please get in touch with **NF Corporation** or one of our representatives.

In such a case, let us know the model name (or product name), serial number (**SERIAL No.** given on the nameplate), and symptom and operating conditions as detail as possible.

Though we will make efforts to reduce the repair period, when five or more years have passed since you purchased the product, it may take time due to, for instance, the out of stock of repair parts.

Also, if the production of repair parts is discontinued, the product is extremely damaged, or the product is modified, we may decline the repair.

If there are any misplaced or missing pages, we will replace the manual. Contact the sales representative.

NOTES

- Reproduction of the contents of this manual is forbidden by applicable laws.
- The contents of this manual may be revised without notice.
- Information provided in this manual is intended to be accurate and reliable. However, we assume no responsibility for any damage regarding the contents of this manual.
- We assume no responsibility for influences resulting from the operations in this manual.

LI5655 / LI5660 INSTRUCTION MANUAL (OPERATIONS)

NF Corporation

3-20 Tsunashima Higashi 6-chome, Kohoku-ku. Yokohama-shi 223-8508, Japan

Phone +81-45-545-8111

Fax +81-45-545-8191

<http://www.nfcorp.co.jp/>

© Copyright 2016-2022, **NF Corporation**

