



PROGRAMMABLE AC/DC POWER SOURCE

KP3000S

INSTRUCTION MANUAL

NF Corporation

DA00030908-006

PROGRAMMABLE AC/DC POWER SOURCE

KP3000S

INSTRUCTION MANUAL

Preface

Thank you for purchasing our Programmable AC/DC Power Source KP3000S.

For safe and correct use of the electrical product, please first read "Safety Precautions" on the next page.

- Alert symbols in this manual

This manual uses the following alert symbols. The instructions by these alert symbols shall be carefully obeyed to ensure equipment operator's safety and prevent damage to equipment.

 WARNING

Equipment handling could result in death or serious injury. This symbol contains information to avoid such risk.

 CAUTION

Equipment handling could result in minor or moderate injury, or property damage. This symbol contains information to avoid such risk.

- This manual consists of the following chapters.

If it is the first time for you to use this product, start with "1. Outline."

1. **Outline:** Explains the overview, configuration, and features of this product.
2. **Preparation before Use:** Explains the preparations carried out before installation or operation.
3. **Basic operation:** Explains the component names and basic operations.
4. **Advanced Operation:** Explains the operations more extensively.
5. **Description of Screen and Menu:** Explains the screen configuration and menu composition.
6. **Remote Control:** Explains the remote control via communication interface.
7. **Options:** Explains the available options.
8. **Troubleshooting:** Explains the remedies when an error message is displayed, or when a failure is suspected.
9. **Maintenance:** Explains the methods of storage, repackaging, transportation, and maintenance.
10. **Specifications:** Provides the list of specifications of functions and performance.

- Scope of contents

The description of this manual applies to products with firmware version 1.40 and above.

For details on checking the firmware version, see Chapter 9.4.

———— Safety Precautions ————

For safe use, ensure to obey the following warnings and considerations.

We are not responsible for damage resulting from failure to obey these warnings and considerations.

This product is an insulation Class I device (with a protective conductor terminal) complying with the JIS and IEC standards.

- Ensure you obey the instructions in this instruction manual.

This instruction manual contains instructions for safe operation and use of this product.

Before using this product, please read this manual first.

All the warning items contained in this instruction manual are intended for preventing risks that may lead to serious accidents. Ensure to obey them.

- Ensure to ground.

Ensure to connect the protective conductor terminal of the power input terminal of this product to an earth ground so that ground resistance is 100 Ω or less. If the product is not certainly grounded, an electric shock might occur.

To prevent electric shock, ensure that the protective grounding conductor is connected before you connect a cable to the power input terminals L and N.

For grounding, use the supplied power cable or an equivalent cable whose diameter is same or greater.

- Check the power supply voltage.

This product operates on the power supply voltage specified in "*2.4 Grounding and Power Connections*". Before connecting this product to a power supply, make sure that the voltage of distribution board conforms to the power supply voltage rating of the product.

- If you notice anything strange

If this product produces smoke, unusual odor, or strange sound, immediately cut the power to the product and stop using it.

Should you encounter any anomaly like above, immediately contact us or our agent. Never use it until the repair is completed.

- Do not use in a gaseous atmosphere.

This may pose a risk of explosion or other.

- Do not remove the cover.

This product has high-voltage portions inside. Never remove the cover.

When inspection into the inside of the product is needed, never allow anybody to touch the innards except our certified service engineers.

- Do not modify the product.

Never modify the product. Modification to the product may pose a new risk. We may refuse the repair of a modified product at fault.

- Prevention of electric shock by output voltage

The maximum output of this product is ± 440 V. Be careful to avoid electric shock. Directly touching the output or changing the cable connection while the output is on may cause electric shock.

- This product weights over 18 kg.

Do not carry it alone, or you may suffer physical injury.

- Do not expose this product to water.

When this product is used in wet condition, it may cause an electric shock and a fire. If this product is exposed to water, cut the power at the distribution board immediately, and contact NF Corporation or one of our representatives.

- If lightning occurs, power off this product and cut the power at the distribution board.

A lightning may cause an electric shock, a fire and a failure.

- Safety symbols

The following shows the general definitions of the safety symbols used on the product main unit and in the instruction manual.



Refer to the instruction manual

This notifies the user of potential hazards and indicates that he/she must refer to the instruction manual.



Electric shock hazard

This indicates that an electric shock may occur under specific conditions.



Protection conductor terminal

This indicates that the terminal needs to be grounded in order to prevent electric shock accidents.

Before operating the equipment, ensure to connect this terminal to an earth ground so that ground resistance 100 Ω or less.



Warning

Equipment handling could result in death or serious injury. This symbol contains information to avoid such risk.



Caution

Equipment handling could result in minor or moderate injury, or property damage. This symbol contains information to avoid such risk.

- Other symbol

 Chassis

This indicates that the terminal (or external conductor for a connector) is connected to the chassis.

- Request about disposal

For environmental preservation, this product shall be disposed of through an appropriate industrial waste disposer.

This product does not include a battery.

Table of Contents

	Page
Preface	i
Safety Precautions.....	ii
List of Figures	xi
List of Tables	xiii
1. Outline.....	1
1.1 Overview.....	2
1.2 Polyphase System Configuration	2
1.3 Features	2
2. Preparation before Use.....	5
2.1 Check before Use	6
2.2 About Installation Environment	6
2.3 Cautions during Moving and Transportation.....	8
2.4 Grounding and Power Connections	10
2.5 Output and System Cable Connection	14
2.5.1 Polyphase System.....	17
2.6 How to Tilt Control Panel	20
2.7 Simple Operation Check.....	21
2.8 Calibration	23
3. Basic Operation.....	25
3.1 Component Name.....	26
3.1.1 Front.....	26
3.1.2 Rear.....	28
3.1.3 Control Panel.....	30
3.2 Power On/Off.....	31
3.2.1 Before Turning on the Power	31
3.2.2 Power On.....	32
3.2.3 Screen Display and Operations at Starting Up.....	32
3.2.4 The Settings Loaded after Startup	33
3.2.5 Checking the Rated Power	33
3.2.6 Power Off	33
3.3 Basic Key Operations	34
3.3.1 Changing the Output Function (Continuous/Sequence/Simulation).....	34
3.3.2 Item Selection.....	34
3.3.3 Using Soft-keys	35
3.3.4 Closing Windows	36
3.3.5 Entering Values (Numerical Entry Box).....	37
3.3.6 Entering Strings (Character String Entry Box).....	37

3.3.7	Using Shortcut Operations (SHIFT Key)	39
3.4	Using the Continuous Function	40
3.4.1	Setting the AC/DC Mode and the Signal Source	40
3.4.2	Setting the Output Range	43
3.4.3	Setting Waveforms	44
3.4.4	Setting the Output Voltage (Single-phase Output)	46
3.4.5	Setting the Output Voltage (Polyphase Output)	47
3.4.6	Setting the Output Frequency	49
3.4.7	Setting the Output On/Off Phase	49
3.4.8	Turning the Output On or Off	50
3.4.9	Using the Measurement Function	51
3.4.10	Switching the Display Format (RMS/AVG/Peak) of the Measured Value	52
3.4.11	Enlarge Display Letters for the Measured Value	54
3.4.12	Clearing the Output Current Peak-hold Value	56
3.4.13	Switching the Target Phase of which the Measured Values are Displayed (Polyphase Output)	58
4.	Advanced Operation	61
4.1	Using Limiter, Setting Limiter	62
4.1.1	Use Peak Current Limiter	62
4.1.2	Using RMS Current Limiter	64
4.1.3	Using Voltage Setting Range Limit	66
4.1.4	Using Frequency Setting Range Limit	67
4.1.5	About Wattage Limiter	68
4.2	Using Sequence Function	69
4.2.1	Basics	69
4.2.2	Parameters of Sequence Function	72
4.2.3	Example of Output Using Sequence Function	75
4.2.4	Process Flow in a Step	75
4.2.5	Edit a Sequence	77
4.2.6	Load a Sequence	80
4.2.7	Execute a Sequence	84
4.2.8	Save a Sequence	88
4.2.9	Clear/Rename Sequence	92
4.2.10	Set so as the Sequence Function is Selected at Power-on	96
4.2.11	Sequence Control by External Control	97
4.2.12	Screen Overview	97
4.3	Using Power Fluctuation Testing (Simulation) Function	99
4.3.1	Basics	99
4.3.2	Simulation Function Parameters	100
4.3.3	Output Examples Using Simulation Function	102
4.3.4	Process Flow in a Step	104
4.3.5	Editing Simulation	104

4.3.6	Loading a Simulation	107
4.3.7	Executing Simulation	110
4.3.8	Saving Simulation	112
4.3.9	Clear/Rename Simulation	116
4.3.10	Set so as the Simulation Function is Selected at Power-on	120
4.3.11	Simulation Control by External Control	121
4.3.12	Screen Overview	121
4.4	Measuring Harmonic Current	123
4.4.1	Harmonic current	123
4.4.2	Basics	124
4.4.3	Measured Value Display Method	124
4.5	Measuring Inrush Current	125
4.5.1	Inrush Current	125
4.5.2	Basics	126
4.5.3	Measurement Method	126
4.5.4	Measurement Tips	127
4.6	Using Clipped Sine Wave	127
4.7	Outputting Arbitrary Waveform	130
4.7.1	Basics	130
4.7.2	Arbitrary Waveform Creation Procedure	131
4.7.3	Arbitrary Waveform Creation Example	131
4.7.4	Transferring Arbitrary Waveform	131
4.7.5	Outputting Arbitrary Waveform	134
4.8	Using Memory Function	135
4.8.1	Basic Setting Memory	136
4.8.2	Arbitrary Waveform Memory	143
4.8.3	Sequence Memory	147
4.8.4	Simulation Memory	148
4.9	Using USB Memory Function	149
4.10	Using Monitor Function	150
4.11	Using Remote Sensing Function	153
4.12	Using AGC Function	155
4.13	Using Autocal Function	158
4.14	Adjusting DC Offset	162
4.15	Using for Unbalanced Polyphase Output	164
4.16	Using as DC Power Supply	166
4.17	Setting Voltage using External DC Input Signal	167
4.17.1	Using External Signal in AC-VCA Mode	167
4.17.2	Using External Signal in DC-VCA Mode	169
4.18	Control Using External Control Function	171
4.19	Synchronizing the Output Frequency with the Power Line or the External Signal ...	176
4.20	Amplifying the External Signal Input	178

4.21	Turning the Output On or Off Rapidly.....	179
4.22	Enabling Automatic Output-On at Power-On.....	181
4.23	Using the Emission CO ₂ Calculator	182
4.24	Power Unit Energization Setting (Using Under the Restricted Rated Power)	184
4.25	Key Lock.....	186
4.26	Beep.....	186
4.27	Changing the Background Color and the Contrast of the Screen.....	187
4.28	Restoring to the Factory Default Setting (Reset).....	188
5.	Description of Screen and Menu.....	193
5.1	Screen Configuration	194
5.1.1	Status Icon	195
5.1.2	Measured Value Display Items	196
5.1.3	Output Setting Display Items	197
5.1.4	Warning and Error Display.....	197
5.2	Menu Composition.....	198
5.2.1	Menus of the Continuous Function	198
5.2.2	Menus of the Sequence Function	199
5.2.3	Menus of the Simulation Function.....	200
5.2.4	Menus of the Memory Function	200
5.2.5	System Menus	201
6.	Remote Control	203
6.1	Communication Interface	204
6.1.1	USB.....	204
6.1.2	RS232	206
6.1.3	GPIB.....	208
6.1.4	LAN	210
6.2	Remote/Local State Switching	213
6.2.1	Remote State.....	213
6.2.2	Local State	213
7.	Options.....	215
7.1	Outlet.....	216
7.2	Casters	216
7.3	Application Software	216
7.4	System Cable (for Polyphase System).....	217
7.5	Remote Controller.....	217
7.6	Replacement Air Filter	218
7.7	Rack-Mount Adapter	218
7.8	Additional Cable	218
8.	Troubleshooting	219
8.1	Error Messages and Error Handling.....	220
8.1.1	Error Message Screen.....	220
8.1.2	If An Error Message is Displayed.....	220

8.1.3	If An Error Occurs Repeatedly	221
8.1.4	Protection Operation Types	222
8.1.5	Error Message List	223
8.2	When a Failure is Suspected	227
9.	Maintenance	233
9.1	Preface	234
9.2	Daily Maintenance	234
9.3	Storage, Repackaging, Transportation	236
9.4	Checking Firmware Version	237
10.	Specifications	239
10.1	Output Function	241
10.2	Output Range	241
10.3	AC/DC Mode.....	241
10.4	Signal Source	242
10.5	AC Output.....	243
10.6	DC Output.....	245
10.7	Output Voltage Stability.....	245
10.8	Distortion of Output Voltage Waveform	245
10.9	Power Input	246
10.10	Withstand Voltage and Insulation Resistance	246
10.11	Measurement Function	246
10.12	Power Unit Energization Setting	248
10.13	Current Limiter.....	249
10.14	Setting Range Limit Function.....	250
10.15	Remote Sensing	251
10.16	AGC.....	251
10.17	Autocal (Output Voltage Compensation)	252
10.18	Sequence	253
10.19	Simulation.....	254
10.20	Clipped Sine Wave	255
10.21	Arbitrary Wave	255
10.22	External Signal Input.....	256
10.22.1	External Synchronous Signal Input (Signal Source SYNC only)	256
10.22.2	Voltage Setting Signal Input (Signal Source VCA only)	256
10.22.3	External Signal Input (only EXT and ADD).....	257
10.23	General Function	257
10.24	Memory Function	258
10.25	Self-diagnosis/Protection Function.....	259
10.26	External Control I/O	260
10.27	External Interface	261
10.28	USB Memory Interface.....	262
10.29	Waveform Monitor Output.....	262

10.30 Safety, EMC, and RoHS	262
10.31 Operation Environment	263
10.32 Externals, Weight, and Terminal Block	263
10.33 Option	264
10.34 Outline Dimensional Drawing	265
Index	266

Figures and Tables

■List of Figures

	Page
Figure 2-1 How to Use the Adjuster Foot (Caster Type)	7
Figure 3-1 Component Name (Front)(Foot Type)	26
Figure 3-2 Component Name (Front) (When the outlet is selected)(Caster Type).....	26
Figure 3-3 Component Name (Rear)(Foot Type)	28
Figure 3-4 Component Name (Rear) (Caster Type)	28
Figure 3-5 Component Name (Control Panel)	30
Figure 3-6 The Self Check Screen to be Displayed when Starting the Unit in Other System or in Other Output Phase Configuration than before	32
Figure 3-7 The Rated Power Icon	33
Figure 3-8 The Root Menu	34
Figure 3-9 The Example of a Selection Box	35
Figure 3-10 The Example of a Data List Box.....	35
Figure 3-11 Soft-key Function.....	35
Figure 3-12 The Example of the Window with the [Close] Button.....	36
Figure 3-13 The Example of the Window with the [OK]/[Cancel] Button.....	36
Figure 3-14 The Numerical Entry Box	37
Figure 3-15 Character String Entry Box	38
Figure 3-16 The Normal View (left) and the Simple View Mode (right)	54
Figure 4-1 Step-control Parameters and intra-Step Parameters	70
Figure 4-2 Step Behavior	71
Figure 4-3 Stop Phase	74
Figure 4-4 Example of Sequence.....	75
Figure 4-5 Process Flow in Sequence Step	76
Figure 4-6 Branch Operation/Stop Operation.....	76
Figure 4-7 Sequence Edit View.....	98
Figure 4-8 Sequence Control View (Output Off State)	98
Figure 4-9 Sequence Control View (Output On State/Sequence in Execution)	98
Figure 4-10 Sequence Control View (Output On State/Sequence Stopped)	99
Figure 4-11 Simulation Function Steps	101
Figure 4-12 Voltage Dip Simulation Example.....	102
Figure 4-13 Voltage Change Simulation Example.....	103
Figure 4-14 Process Flow through Simulation Steps.....	104
Figure 4-15 Stop Operation	104
Figure 4-16 Simulation Edit View	122
Figure 4-17 Simulation Control View (Output Off State, Simulation Stopped)	122
Figure 4-18 Simulation Control View (Output On State, Simulation Running)	122

Figure 4-19 Simulation Control View (Output On State, Simulation Stopped)	123
Figure 4-20 Current Waveform Containing Many Harmonic Components	123
Figure 4-21 Inrush Current Example	125
Figure 4-22 Clipped Sine Wave	127
Figure 4-23 USB Memory Folder Structure	149
Figure 4-24 The Message Window to be Shown Before the Automatic Output-On After the Power-On	181
Figure 5-1 Component Name (Display Areas on the Screen).....	194
Figure 5-2 Menu Composition.....	198
Figure 7-1 Remote Controller External View	217
Figure 7-2 Front Grills	218
Figure 8-1 Error Message Screen Example	220
Figure 10-1 Range of Ambient Temperature/Humidity	263
Figure 10-2 Outline Dimensional Drawing.....	265

■List of Tables

	Page
Table 2-1 List of Content.....	6
Table 2-2 Heat Value	6
Table 2-3 Mass	7
Table 2-4 Power Input Terminal.....	11
Table 2-5 Maximum Input Power/Current and Power Input Cable.....	11
Table 2-6 Output Terminals	14
Table 2-7 Outlet List	16
Table 3-1 Component Name (Front)	27
Table 3-2 Component Name (Rear).....	29
Table 3-3 Component Name (Control Panel)	30
Table 3-4 How the Rated Power Icon is Displayed Depending on the Power Unit Energization Setting	33
Table 3-5 Character String Entry List.....	38
Table 3-6 Shortcut Operations	39
Table 3-7 Description of the AC/DC Mode	40
Table 3-8 The Description of the Signal Source.....	40
Table 3-9 List of the Selectable Combinations of the AC/DC Mode and the Signal Source.....	41
Table 3-10 The Setting Range per Output Range	43
Table 3-11 Main Measurement Functions	51
Table 3-12 The Measuring Mode for the Measured Values of the Output Voltage and Output Current	52
Table 4-1 Wattage Limiter Value per Phase	69
Table 4-2 Parameters of Sequence Function.....	72
Table 4-3 Example of Editing Sequence	75
Table 4-4 Simulation Function Parameters	100
Table 4-5 Simulation Function Steps and Settable Step Parameters	101
Table 4-6 Voltage Dip Simulation Edit Example	103
Table 4-7 Voltage Change Simulation Edit Example.....	103
Table 4-8 Different Output Voltage Settings Depending on Clip Depth Setting Method	128
Table 4-9 Content Saved in Sequence Memory	147
Table 4-10 Content Saved in Simulation Memory	148
Table 4-11 Setting Range of DC Offset Adjustment Value	162
Table 4-12 CONTROL I/O Pin Assignment	172
Table 4-13 Step sync code.....	173
Table 4-14 Memory specification.....	173
Table 4-15 The Output Terminal Impedance in the Output Off State when the Activation of the Output Relay is Disabled	179
Table 4-16 Setting Items to be Reset.....	188
Table 5-1 Component Name (Display Areas on the Screen).....	194
Table 5-2 Status Icons	195

Table 5-3 Measured Value Display Items.....	196
Table 5-4 Output Setting Display Items.....	197
Table 5-5 Menus of the Continuous Function.....	198
Table 5-6 Menus of the Sequence Function.....	199
Table 5-7 Menus of the Simulation Function.....	200
Table 5-8 Menus of the Memory Function.....	200
Table 5-9 System Menus	201
Table 7-1 Outlet	216
Table 7-2 Rack-Mount Adapter Model Names	218
Table 8-1 Description of the Error Message Screen.....	220
Table 8-2 Error Message List.....	223
Table 8-3 Actions When a Failure is Suspected.....	227

1. Outline

1.1	Overview	2
1.2	Polyphase System Configuration	2
1.3	Features	2

1.1 Overview

Programmable AC/DC power source KP3000S is a multifunction power source which can output 3 kVA AC / 3 kW DC at a maximum. It also provides various interfaces such as the external control input/output, communication interface, and remote controller (optional) to address a wide variety of usage. In addition you can configure single-phase three-wire or three-phase four-wire power source system with a respective System Cable (optional).

1.2 Polyphase System Configuration

You can connect two or three KP3000S using an optional System Cable to allow single-phase three-wire output or three-phase four-wire output, respectively (polyphase system).

1.3 Features

■ Various interfaces to address a variety of usage

The interface to use for the remote controlling from a computer or sequencer is equipped. USB and RS232 interface are standard, and either GPIB or LAN (LXI 1.4) interface can be chosen when ordering. You can use a contact/TTL signal to turn the output on/off or switch the memory without using a computer. The product also offers the status output for showing the device status and the output which is synchronized with Sequence or Simulation step. With these functions you can achieve various types of systemization and automatization. The AGC function and Autocal function for calibrating the output voltage drop are also provided.

■ Variable current limiter

This function can limit the effective value and the positive/negative peak value of the output current where the limiting value is variable. You can set the limiter so that the output is turned off when the limited condition continues for a certain time.

■ Globally adjustable power inlet without restricted by the power supply environment

KP3000S supports a wide range of power input from 100 V to 230 V.

■ Feature-rich measurement function

On the panel the product displays the effective value, peak value, average DC value, current peak-hold value, and active/apparent power of the output voltage/current, the power factor, crest factor, reactive power, and harmonic current.

■ Control Software (Optional)

You can perform the following operations by using optional Control Software:

- Operations same as those performed on the control panel
- Editing/transferring/exporting the arbitrary waveform data*
- Data logging (importing the measured values)
- Editing/transferring/exporting*/performing Sequence
- Editing/transferring/exporting*/performing Simulation

*Exporting the data to USB memory allows the data to be set to KP3000S.

■ USB memory support (supported format type: FAT32)

You can write/read the following data to/from a commercial USB memory stick:

- Basic setting
- Sequence
- Simulation
- Arbitrary waveform

■ Restriction of CO₂ emission (= power usage) and the display of CO₂ emission (= power usage) during operation

The efficiency is improved by about 27 % compared to the linear amplifier method by adopting the switching amplifier method. When the power output is low, the internal loss can be lowered by reducing the number of power units being powered on. The function for calculating and displaying the CO₂ emission from the internal loss or output power is equipped.

■ Options (partial)

- Remote Controller

A remote controller with the numeric keypad, jog, and shuttle.

- System Cable (for single-phase three-wire/three-phase connection)

Connect two or three KP3000S by this cable to configure a polyphase output system.

2. Preparation before Use

2.1	Check before Use	6
2.2	About Installation Environment	6
2.3	Cautions during Moving and Transportation.....	8
2.4	Grounding and Power Connections	10
2.5	Output and System Cable Connection.....	14
2.6	How to Tilt Control Panel	20
2.7	Simple Operation Check	21
2.8	Calibration.....	23

2.1 Check before Use

■ Check the safety.

To ensure equipment operator's safety, be sure to read the following sections of the instruction manual at the beginning.

- *Safety Precautions* (Page ii)
- *2.4 Grounding and Power Connections*

■ Check the appearance and contents.

If there is any problem, contact the seller (NF Corporation or our agent) from whom you purchased this product.

● Appearance check

Make sure that there is no damage or dent made during the transportation on the LCD screen, keys, jog, or shuttle of the control panel, or rear connectors.

● Contents (main unit and accessories) check

The contents are listed in Table 2-1. Make sure that all of the main unit and accessories are included.

Table 2-1 List of Content

Content		Quantity
Main unit	Main Unit	1
Accessories	Instruction Manual	1
	Power cable (3 m approx.)	1

2.2 About Installation Environment

To use safely and maintain the reliability, take the followings into consideration:

■ Install the product where the exhaust heat will not damage surroundings.

- This product performs forced air cooling using a fan. Keep the front and rear, on which the air inlet and outlet are located, away from the wall at least 50 cm to secure air circulation.
- This product exhausts the heat from the air outlet on the rear. Do not place heat-sensitive objects around the outlet.
- If you install the product in a closed narrow room, air conditioning equipment is required. The heat value of this product is shown in Table 2-2 (estimate at power input 200 V, rated output).

Table 2-2 Heat Value

	Rated output	Heat value	
KP3000S	3 kVA	0.9 kW	780 kcal/h

Note: Estimate at power input 200 V, rated output

■ Install the product on a sturdy place.

- The floor needs to have enough strength to support the weight of this product. The mass of this product is shown in Table 2-3.

Table 2-3 Mass

	Mass
KP3000S	50 kg approx.

- Do not install this product on a sloped surface. The Adjuster Foot (included within caster type) is only for temporary fixing, and cannot support the unit's own weight. You also must not lean on this product or use it as a support. How to use the Adjuster Foot is shown in Figure 2-1.

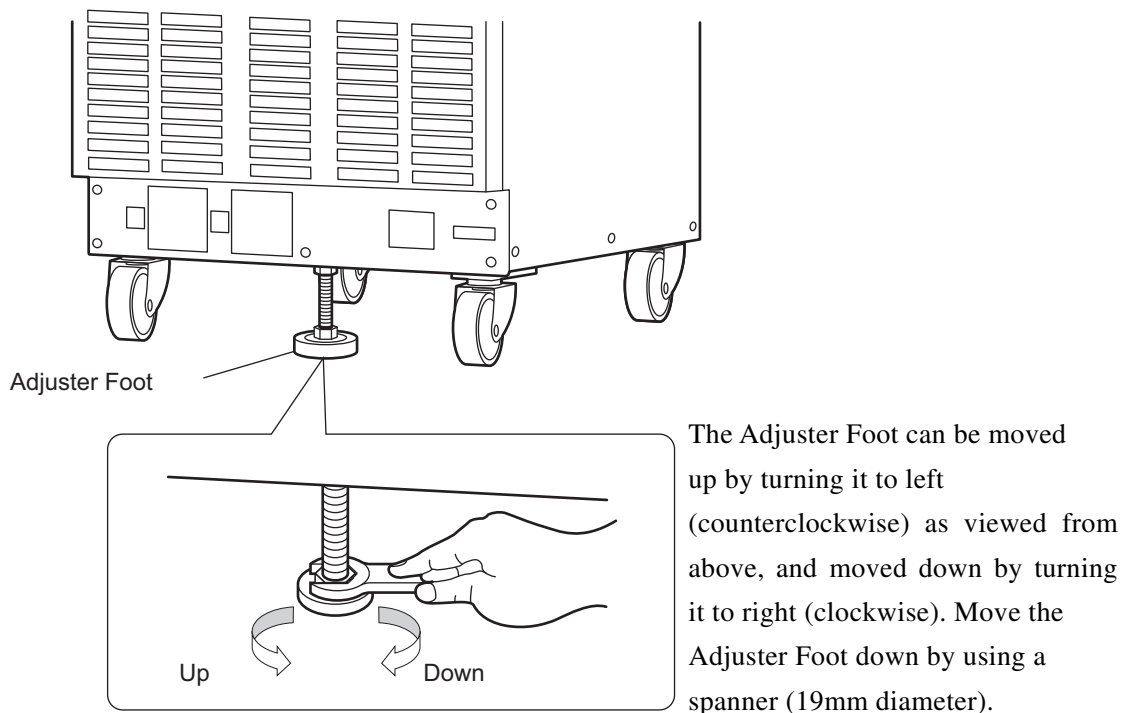

Figure 2-1 How to Use the Adjuster Foot (Caster Type)

■ About arrangement

- Do not place the product on its side, back or top.
- Do not stack the product on top of the other, or place it in front or back of the other (arrangement which makes the cabinet placed behind inhale the exhaust heat of the other).
- When you use multiple cabinets to form a polyphase system, there is no limitation regarding the order of the phases to be arranged. Arrange them in your convenient order within the range of the length of the System Cable.

■ Other installation location conditions

- Use the product indoors, at altitude up to 2000 m.
- Use the product where the temperature is 0 to +50 degrees Celsius, and the humidity is 5 to 85 %RH (the absolute humidity should be 1 to 25 g/m³, without condensation). However, on some specifications, the temperature range limit is stricter.

2. Preparation before Use

- Do not install the product in the following places:
 - Place exposed to inflammable gas
→This may pose a risk of explosion. Never install and use the product in such a place.
 - Outdoors, place exposed to direct sunlight, or place near fire or heat source
→This may reduce the performance, or cause failure.
 - Place exposed to briny air
→ This may cause salt damage.
 - Place exposed to corrosive gas or water, or humid place
→This may cause corrode or failure.
 - Place near electromagnetic field source, high-voltage equipment, or power line
→This may cause malfunction.
 - Place of frequent vibration
→This may cause malfunction or failure.
 - Dusty place
→This may cause failure. Especially do not install the product in a place with conductive dust.
- Electromagnetic emissions from this product may interfere with reception of radio and television broadcasts. Unless the user takes special measures to reduce electromagnetic emissions, using this product in a residential area must be avoided.

2.3 Cautions during Moving and Transportation

Follow the instructions below when moving or transporting this product.

- Remove all wirings connected to this product.

WARNING

- Before removing the wiring, be sure to turn off this product to cut the power from the distribution board. Otherwise, an electric shock might occur.
-

- Check before movement and transportation

- Check the mass before moving the product (Table 2-3).

- Moving with casters

The casters attached to this product (caster type) or optional are intended for use to move the product on a horizontal surface. To move the product on a sloped or uneven surface, licensed personnel should move it by operating a lifting machine or crane instead of the casters.

- As this product is heavy, whenever it is moved, at least two people are required to move it.
- Move the Adjuster Foot (included within caster type) up enough from the floor by using a spanner (19 mm diameter). You can move the Adjuster Foot up by turning it counterclockwise as viewed from above.

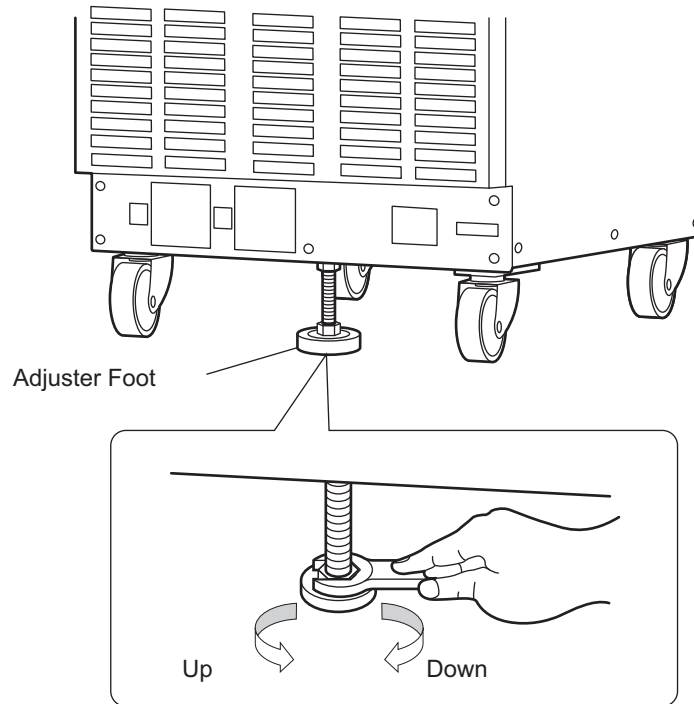

⚠ WARNING

- Do not use the casters to move this product on a sloped surface. This product may move automatically due to its own weight, and cause physical injury.
 - Do not use the casters to move this product on an uneven or irregular surface. This product may fall down, and cause physical injury.
-

2.4 Grounding and Power Connections

■ Ensure to ground.

This product uses a line filter. If the product is not grounded, an electric shock might occur.

⚠ WARNING

- Ensure to connect the protective conductor terminal of the power input terminal of this product to an earth ground so that ground resistance is 100 Ω or less. If the product is not certainly grounded, an electric shock might occur.
 - To prevent electric shock, ensure that the protective grounding conductor is connected before you connect a cable to the power input terminals L and N.
 - For grounding, use the supplied power cable or an equivalent cable whose diameter is same or greater (see Table 2-5).
-

■ Before connecting the product to power source, check the followings.

⚠ WARNING

- The power supply for this product must be taken from the distribution board.
- Be sure to switch off the breaker or the switch at the distribution board before connecting this product to the distribution board. Otherwise, an electric shock might occur.
- Route the wire so that the distance between this product and the distribution board breaker or switch is 3 m or less. If the distance with the distribution board exceeds 3 m, install another breaker or switch within 3 m from this product to connect. Use a breaker complying with IEC 60947-2 or a switch complying with IEC 60947-3 which can disconnect both L and N. (Protective grounding must not be disconnected.) Mark the breaker or the switch with a sign indicating that it is a disconnecting device of power input for this product.

These are from requirements in IEC 61010-1.

⚠ CAUTION

- Condensation may form inside the product when the ambient temperature or humidity changes suddenly, for example, after transportation in winter. In such case, leave the product in room temperature enough time to evaporate the condensation, and then connect the product to the power source.
-

■ Check the power source

For safety, use the product in the ranges of input voltage and frequency described below. Connect the product to a distribution board which provides the power sufficiently higher than the maximum input power of each (see Table 2-5).

Voltage range: Single-phase 100 to 230 V

Frequency range: 50 Hz/60 Hz

■ About power input terminal

Table 2-4 Power Input Terminal

	KP3000S
Screw	M6

■ About power input cable

The power input cable supplied with this product varies in diameter in Table 2-5. A crimp-type terminal is attached to each cable on the end which is to be connected to the input terminal of this product.

- On the supplied power input cable, the end which is to be connected to the distribution board has no terminal attached. Use a crimp-type terminal appropriate for the terminal screw diameter of the distribution board to connect the cable firmly.
- The supplied power input cable is dedicated only to this product. Do not use it with any other product.
- When you use a power input cable other than the one supplied with the product, select a cable which has an appropriate diameter in consideration of the safety standards and consumption current. Use a protective grounding conductor of which diameter is the same or greater than the power input cable.

Table 2-5 Maximum Input Power/Current and Power Input Cable

Rated output	Maximum Input Power	Maximum Input Current		Supplied power input cable	
		Power Input 90 V	Power Input 170 V	For both 100 V and 200 V series (Power Input 90 V or More)	Only for 200 V Series (Power Input 170 V or More)
3 kVA	4.50 kVA	50 A	26 A	14 mm ² approx.	5.5 mm ² approx.

■ Power source connection procedure

Check the current capacity of the single-phase distribution board before wiring. The wiring must be performed by a professional engineer.

⚠ WARNING

- Before connecting this product to the power source, be sure to cut the power to the distribution board. Otherwise, an electric shock might occur.

2. Preparation before Use

1. Remove the resin-molded power input terminal cover and the power input cable holder.

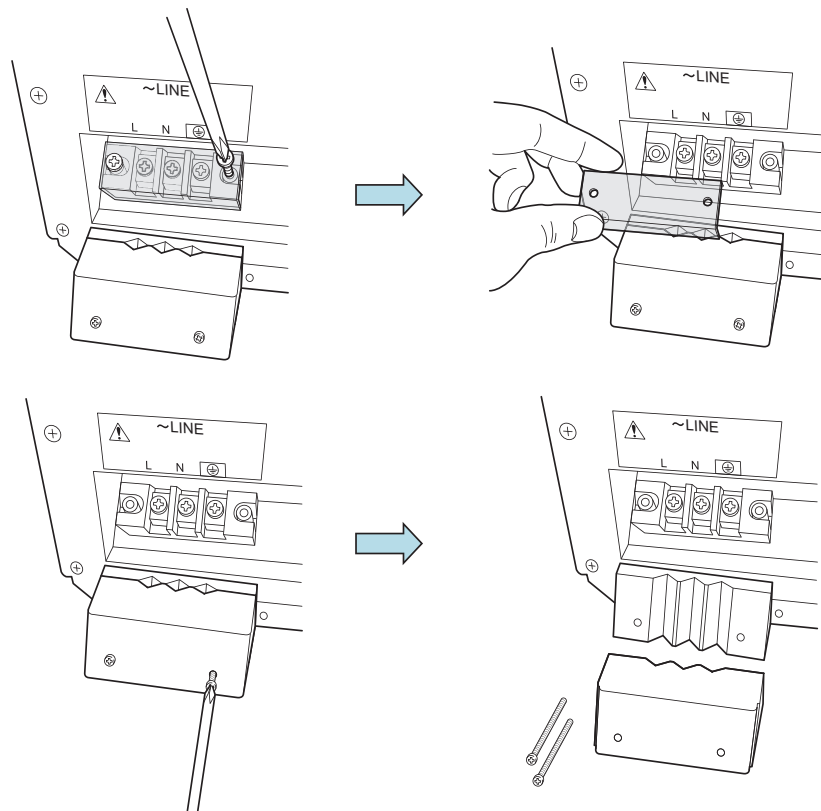

2. Connect the power input cable to the power input terminal of this product. Be sure to tighten the screws firmly.

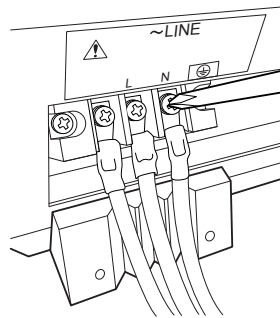

- Attach the resin-molded power input terminal cover and the power input cable holder. Direct the folded part of the resin-molded power input terminal cover to the upper side of the product.

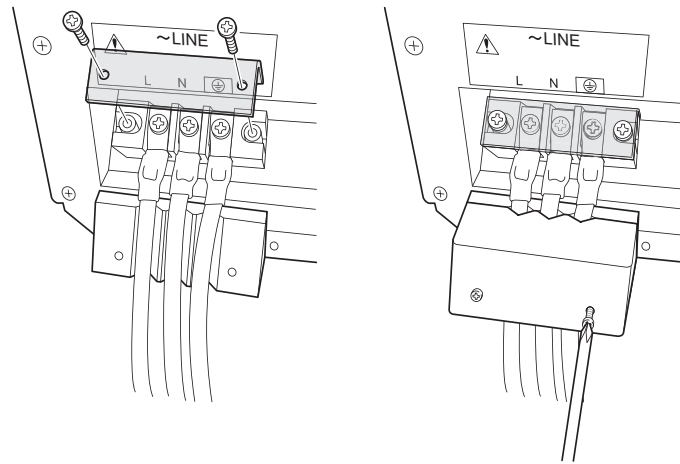

- Ensure that the power switch of this product is turned off, and then connect the power input cable to the single-phase distribution board.

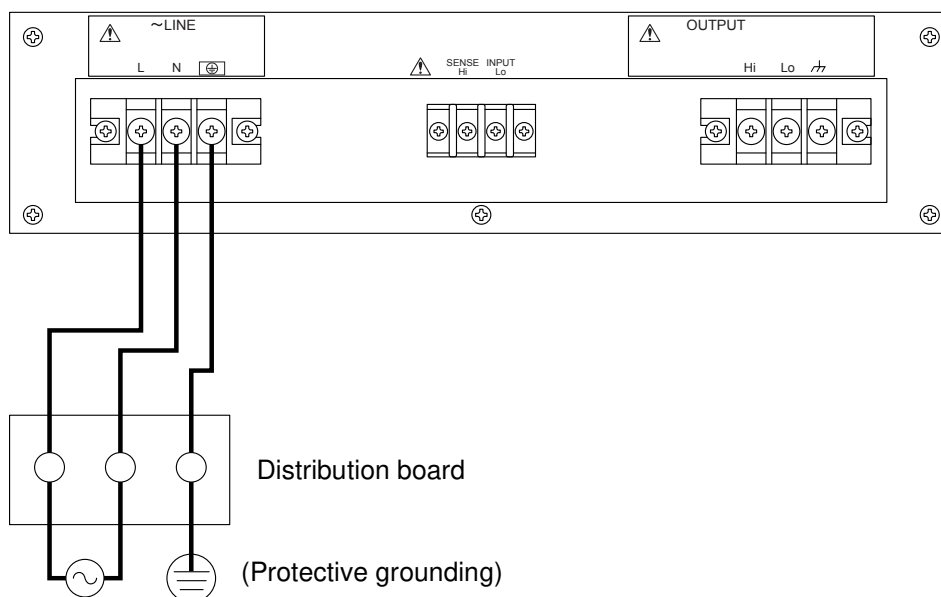

⚠ WARNING

- Do not use this product when the resin-molded terminal cover is removed. Otherwise, an electric shock might occur.

⚠ CAUTION

- Be sure to check phases L and N are correctly connected between this product and the distribution board.

2.5 Output and System Cable Connection

- Before connecting, check the followings.

⚠ WARNING

- Before touching the output terminal, be sure to turn off the power switch of this product, and cut the power to the distribution board. Otherwise, an electric shock might occur.

⚠ CAUTION

- The output terminals that can be grounded are the Lo terminals. Do not ground the Hi terminal.

- About output terminal

Table 2-6 Output Terminals

	KP3000S
Screw	M6

- Connection procedure

1. Remove the resin-molded output terminal cover and the output cable holder of the output terminal.

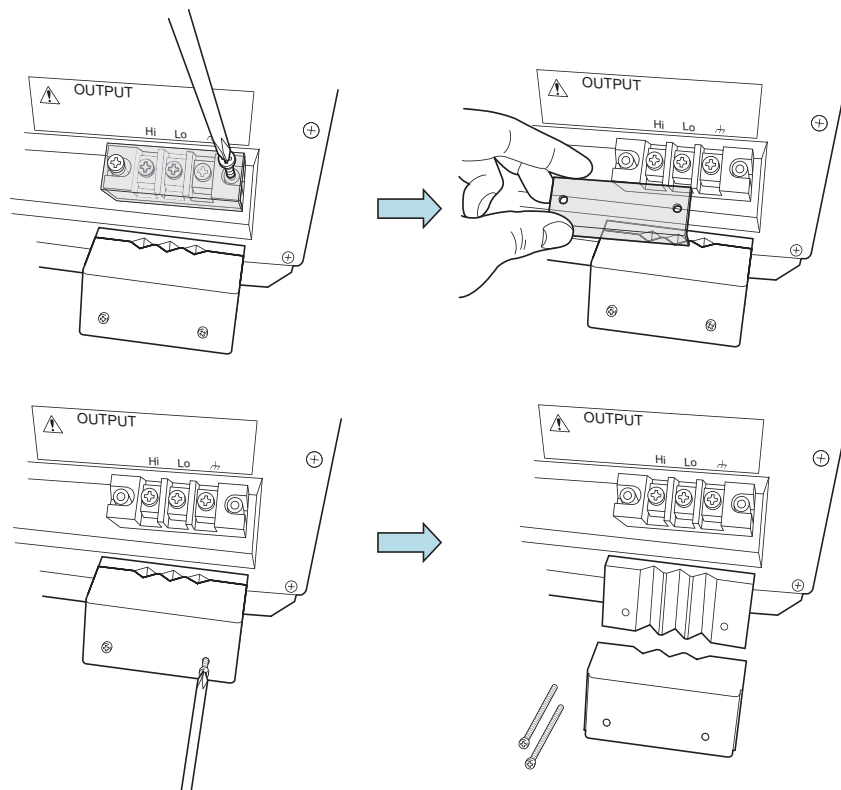

2. Connect the output terminal to the load with a cable. Be sure to tighten the screws firmly. If you want to ground the output terminal at one point only, ground the Lo terminal. The Hi terminal should not be grounded. If the load has a ground terminal, connect it to the chassis terminal of the output terminal of this product.

⚠ CAUTION

- The output terminal that can be grounded is the Lo terminals. Do not ground the Hi terminal.
-

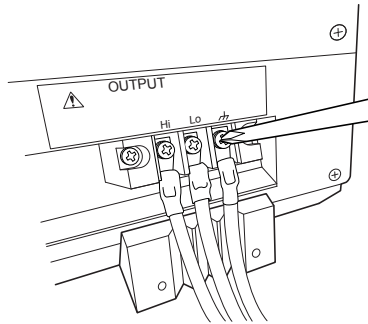

3. Attach the resin-molded terminal cover and the output cable holder. Direct the folded part of the resin-molded terminal cover to the upper side of the product.

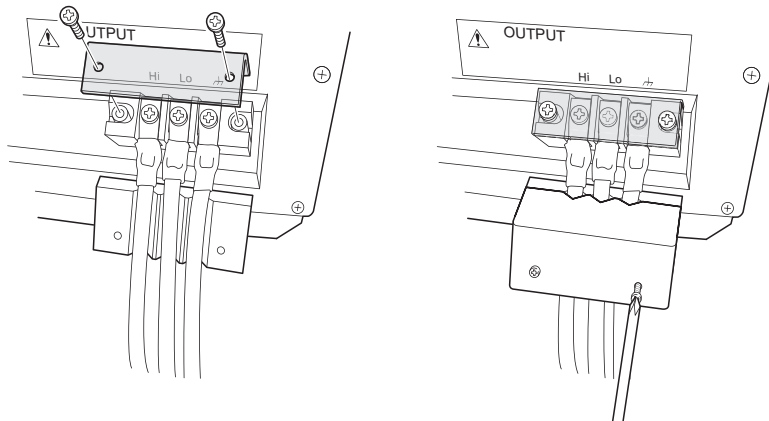

⚠ WARNING

- Do not use this product when the resin-molded terminal cover is removed. Otherwise, an electric shock might occur.
-

■ About outlet (Optional)

The output terminals, the maximum voltage, the maximum current, and available output range are listed in Table 2-7.

Each outlet can provide up to 15 A of current. If a current exceeding 15 A flows, the circuit breaker may operate to cut the output. When the circuit breaker operates, the button is pushed out forward. Pushing in this button resets the breaker, and power can be provided from the outlet.

The outlet is dedicated to AC output. It can be used in the AC or ACDC mode. In the settings below, the outlet is separated from the output by the internal relay of this product. However, only the Hi terminal is separated.

- When in DC mode (DC-INT, DC-VCA)
- When in the 200 V range

Table 2-7 Outlet List

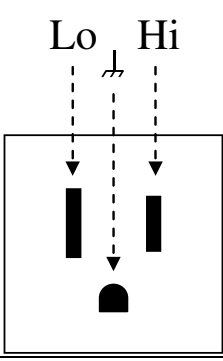
Type	NEMA 5-15
Form And Terminals	
Maximum Voltage	125 Vrms
Maximum Current	15 Arms
Available Output Range	100 V range

⚠ WARNING

- When using the outlet only and not using the outlet terminal, attach the resin-molded terminal cover so that the folded part of it is directed to the lower side of the product, in order to avoid contact with the output terminal.

⚠ CAUTION

- Use the outlet only for AC output without DC offset. Do not take DC output or AC output with DC offset from the outlet.
 - Use the outlet for 15 A or less output.
-

2.5.1 Polyphase System

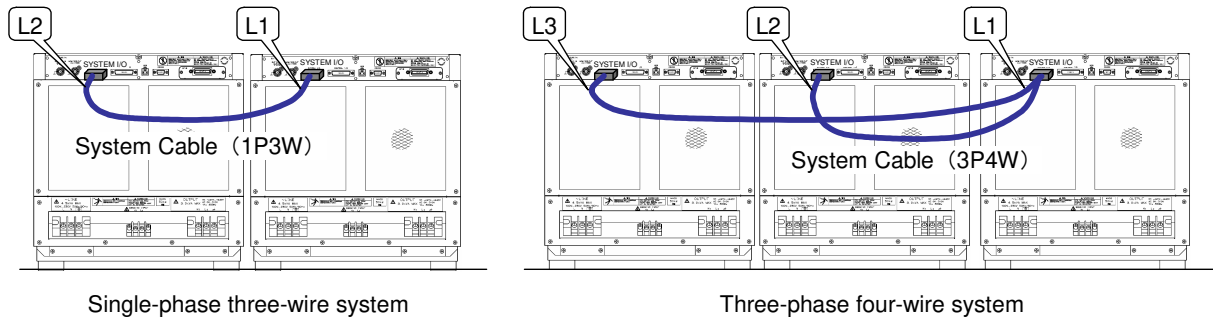

Optional System Cable should be connected to the SYSTEM I/O connector of this product. The cabinet which the L1 connector of the System Cable is connected to becomes L1 phase, and the output terminals Hi and Lo correspond to the L1 and N terminals, respectively. This is same for L2 and L3 phases. This product recognizes the polyphase system by checking the state of the system cable connection at power-on, so connect the System Cable before turning on the power.

Notes

- You cannot connect KP3000S in parallel to boost up a single-phase output.
- Turn on all power supplies within 20 seconds.
- The L2 and L3 cabinets in a polyphase system are restricted in their operation as follows:
 - Cannot use the communication interface (USB, RS232, GPIB, LAN).
 - Cannot use the external control.
 - Cannot use a USB memory.
 - Cannot connect and use the remote controller.
 - Starts according to the contents of the Basic Setting Memory No.1 of the L1 cabinet.
 - Does not accept the control panel key operations except for special cases.
 - Can only display the output measured value of their own cabinet in the measurement display. The display format of the measured value (3.4.10) follows that of the L1 cabinet.
 - System Lock occurs, if the main firmware of each cabinet does not match. For details, see 8.1.5.

■ Connection procedure

1. Connect the connector L1 of the System Cable to the SYSTEM I/O connector of the cabinet which is to be L1 phase. Also connect the L2 and L3 connectors in the same way.

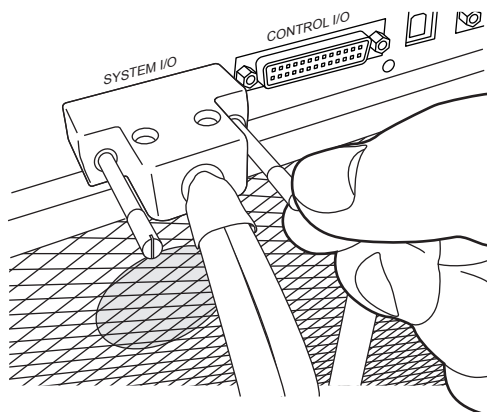

2. Remove the resin-molded output terminal cover and the output cable holder of each cabinet.

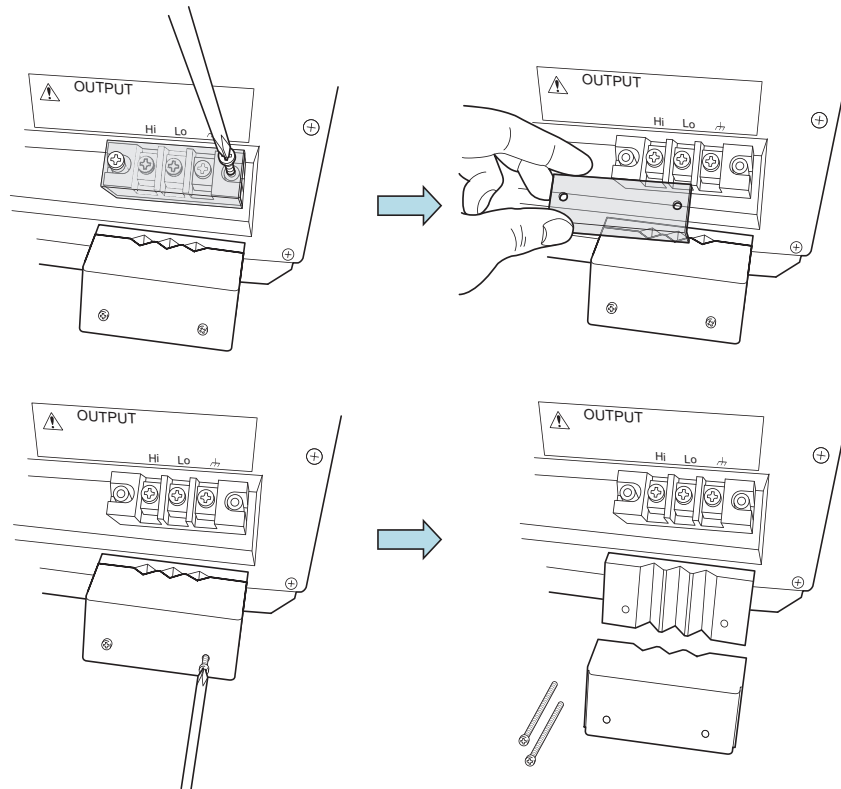

3. Connect the output terminal to the load with a cable. Connect a voltage line to the Hi output terminal of each cabinet. The neutral line can be connected to the Lo terminal with two methods described below. The neutral line can be grounded. If the load has a ground terminal, connect it to the chassis terminal of each output terminal. Be sure to tighten the screws firmly.
 - (a) When connecting the load with the neutral line (single-phase three-wire or three-phase four-wire connection).

Connect the neutral point of load with the Lo terminal of each cabinet using cables with same length and diameter as the voltage line. Alternatively, connect between the Lo terminals of each cabinet by a cable which is as short as possible and has a diameter equal to or more than that of the voltage line, and then connect one of the Lo terminals with the neutral point of load by a cable with same length and diameter as the voltage line.
 - (b) When not connecting the load with the neutral line (three-phase three-wire connection), connect between the Lo terminals of each cabinet by a cable which is as short and thick as possible (with a diameter equal to or more than that of the voltage line).

⚠ CAUTION

- The terminal which can be grounded is the Lo terminal of each cabinet. Do not ground the Hi terminal (L1, L2, and L3 voltage lines).

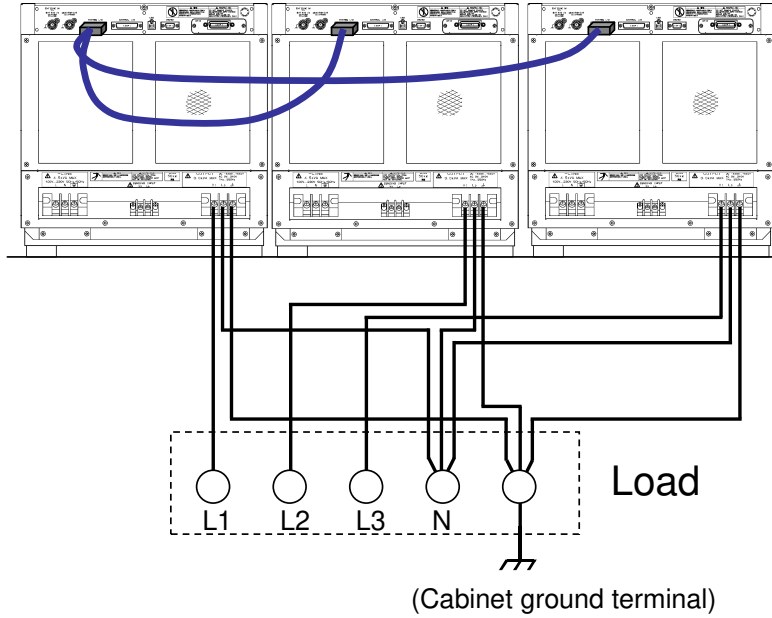

(a) Three-phase four-wire connection

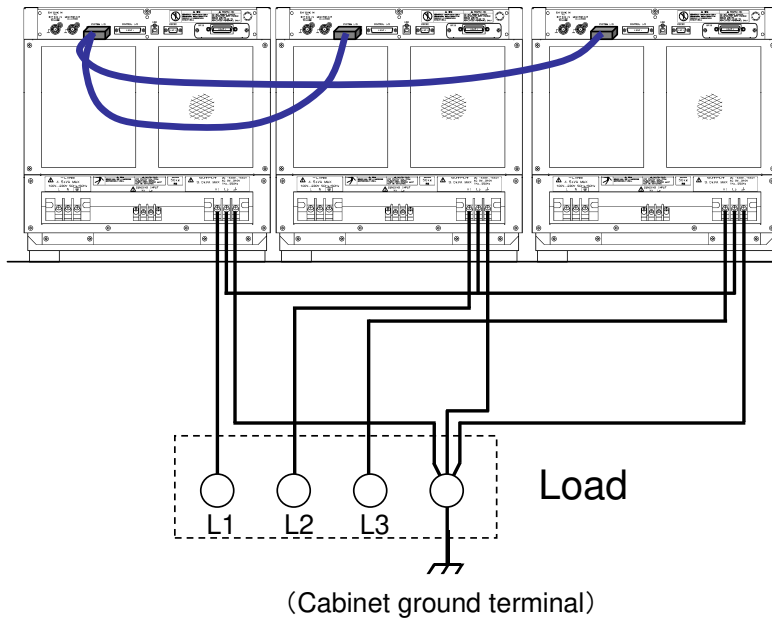

(b) Three-phase three-wire connection

2. Preparation before Use

4. Attach the resin-molded output terminal cover and the output cable holder to each cabinet. Direct the folded part of the resin-molded terminal cover to the upper side of the product.

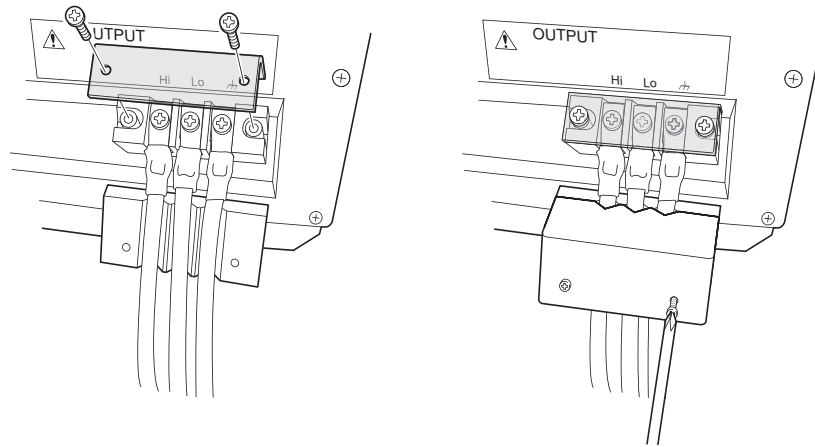

⚠ WARNING

- Do not use this product when the resin-molded terminal cover is removed. Otherwise, an electric shock might occur.
-

2.6 How to Tilt Control Panel

You can tilt up the control panel to operate it. There is a lever in the back under the control panel, which is locked with the hook of the chassis, being pulled by a spring. The hook consists of two steps, which can be used to tilt the control panel and fix it in two ways.

■ Operation procedure

1. Pull the lever in the back under the control panel. The handle moves toward you and the lock of the control panel is released.



2. While holding the lever in pulled position, tilt the control panel by desired degree.



3. Release the lever slowly. The control panel will be locked.

⚠ WARNING

- When closing the control panel, pull the lever and press down on the panel slowly in order to avoid pinching your fingers.
-

2.7 Simple Operation Check

This section describes how to perform a simple operation check when you purchased a new product, or after storing the product for a long period. This check should be performed without load. For a polyphase system, remove the System Cable, and check the single-phase output for each cabinet. If you are not satisfied with the results verified at the operation check, please request the repair to us or our agent.

■ Operation procedure

1. Connect the power supply referring to "*2.4 Grounding and Power Connections.*"
2. Attach the resin-molded output terminal cover and the output cable holder without connecting anything to the output terminals or any other terminal/connector.

2. Preparation before Use

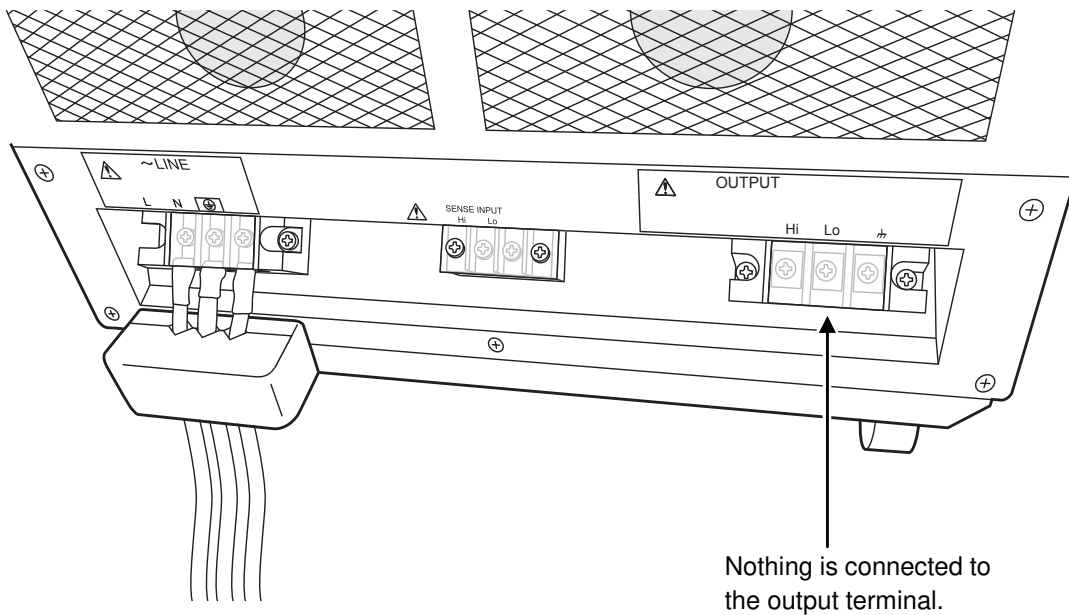

3. Turn on the switch of the distribution board, and then turn on the power switch of this product. Check that all LEDs on the control panel illuminate for several seconds, and then turn off, and that our logo mark appears on the LCD screen (see 3.2.3). If LAN interface is equipped, "LXI" is displayed below the logo mark.

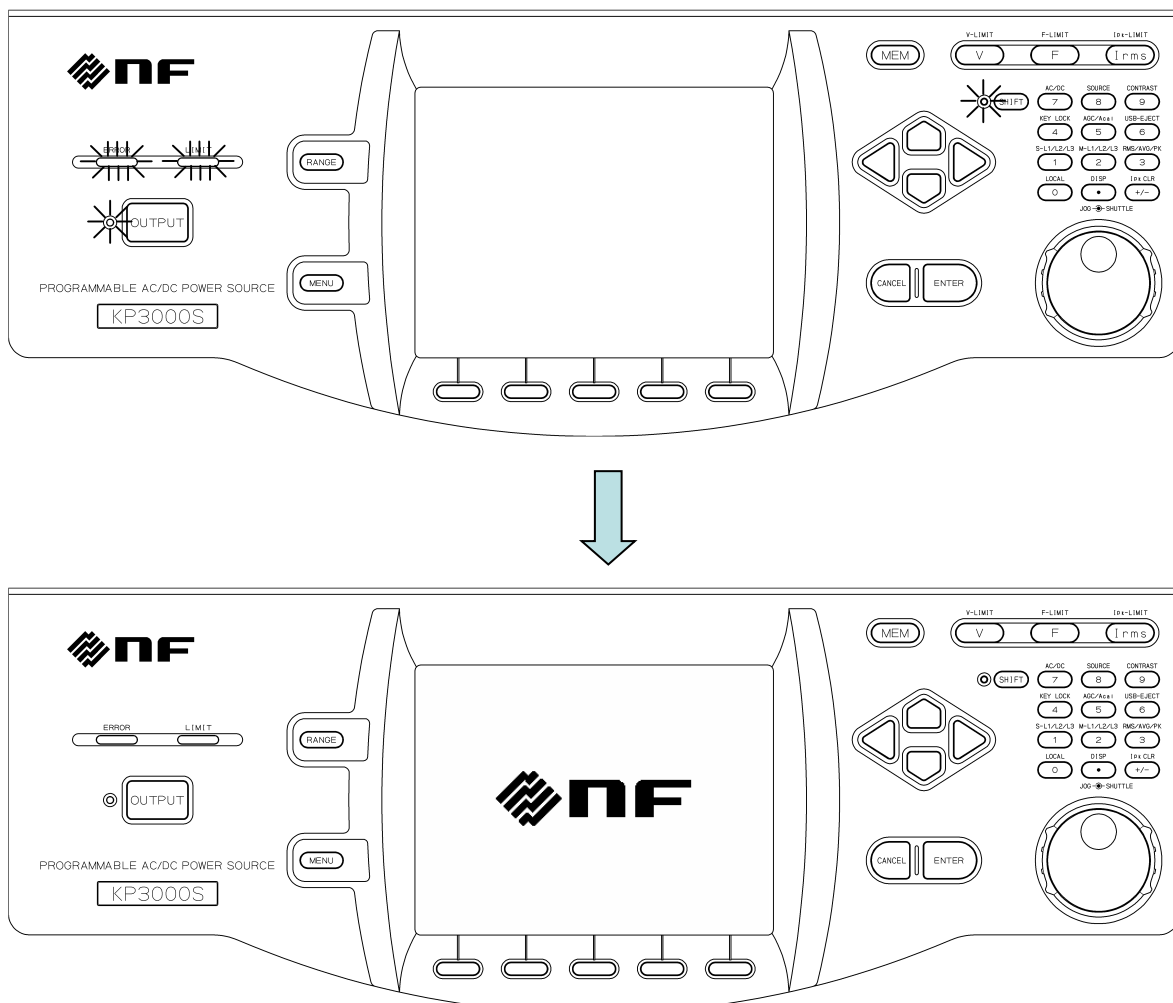

4. Except when you purchased a new product, refer to "4.28 Restoring to the Factory Default Setting (Reset)" to initialize the product to factory defaults. The product will be reset, and display the Continuous screen automatically.
5. When you purchased a new product, the product will start and then display the Continuous screen automatically.
6. Check that the measured values of 100 V range, AC-INT, V, and I are displayed in rms, and that the AC voltage (ACV) is set to 0 V.

Continuous		100V	AC-INT	1P2W
		3.0k		
1φ L1				
V	0.1 Vrms	P	0.0 W	
I	0.04 Arms	S	0.0 VA	
		Q	0.0 var	
		PF	0.00	
Ipk-Hold	-0.31 Apk	CF	4.40	
1φ All				
Freq	50.00 Hz	ACV	0.0 Vrms	
Wave	SIN			
Osc	Measure	Misc	Limiter	

7. Press the OUTPUT key to turn the output on. Press the V key to open the numerical entry box for AC voltage (ACV). Raise the AC voltage setting value gradually by using the jog, shuttle, arrow keys, and numeric keypad.

Continuous		100V	AC-INT	1P2W
		3.0k		
1φ L1				
V	75.0 Vrms	P	0.0 W	
I	0.04 Arms	S	2.7 VA	
		Q	2.7 var	
		PF	0.01	
Ipk-Hold	-0.31 Apk	CF	4.29	
1φ All				
Freq	50.00 Hz	ACV	0.0 Vrms	
Wave	SIN		75.0Vrms	
Osc	Measure	Misc	Limiter	

2.8 Calibration

When the product needs calibration, contact us or our agent.

3. Basic Operation

3.1	Component Name.....	26
3.2	Power On/Off.....	31
3.3	Basic Key Operations.....	34
3.4	Using the Continuous Function.....	40

3.1 Component Name

3.1.1 Front

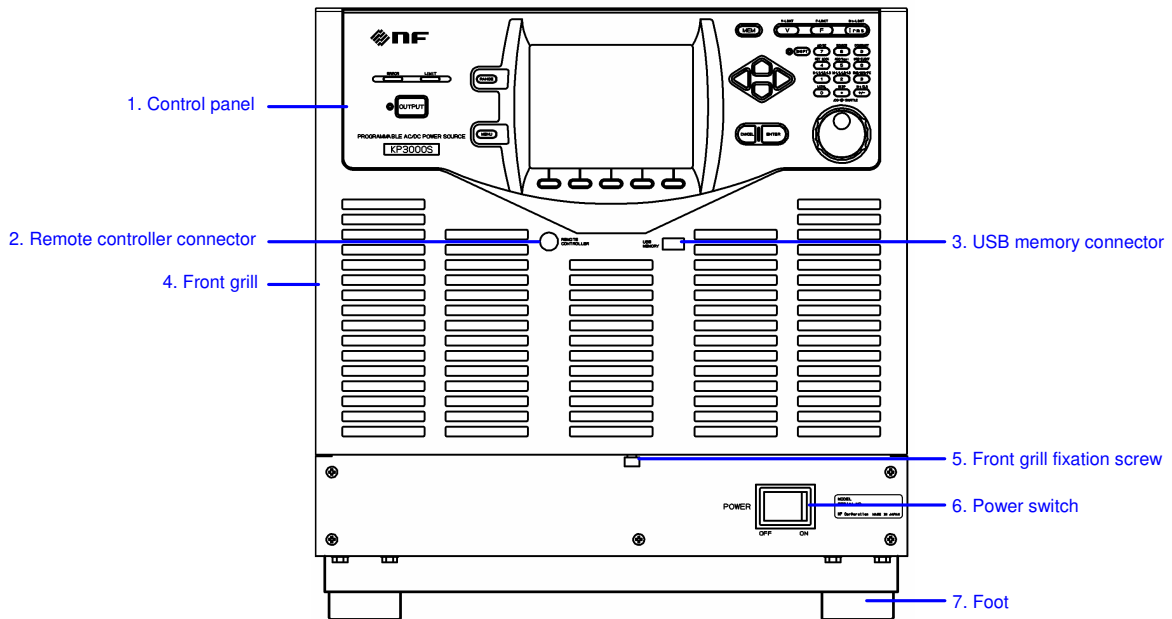

Figure 3-1 Component Name (Front)(Foot Type)

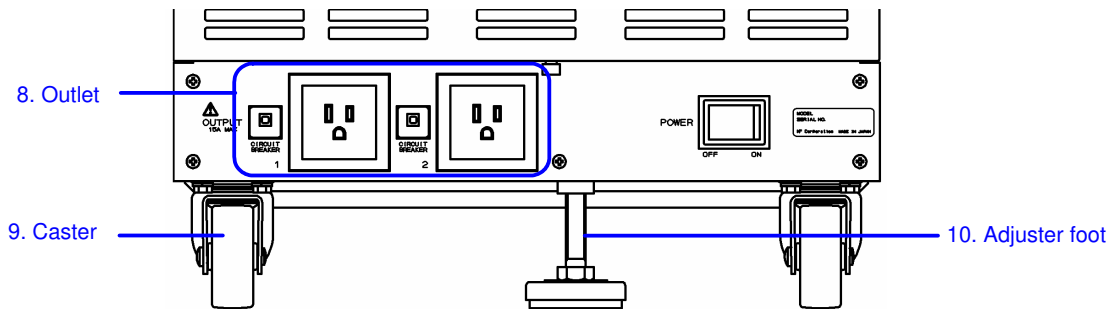

Figure 3-2 Component Name (Front) (When the outlet is selected)(Caster Type)

Table 3-1 Component Name (Front)

Number	Name	Description	Refer to
1	Control panel	Configures the settings and turns the output on or off. Information such as setting values and measured values is displayed on the LCD screen.	3.1.3
2	Remote controller connector	Optional remote controller can be connected.	7.5
3	USB memory connector	USB memory can be connected.	4.9
4	Front grill	The fresh air inlet. An air filter is attached.	9.2
5	Front grill fixation screw	Screw for fixing front grilles.	9.2
6	Power switch	Turns the power on/off.	3.2
7	Foot	It is a foot made of rubber.	-
8	Outlet [†]	Can provide up to 15 A of AC output per outlet.	2.5
9	Caster ^{† ‡}	Caster with the freely movable front-wheels and fixed rear-wheels. Can be used to move this product in the horizontal location.	2.3
10	Adjuster Foot ^{† ‡}	Can be used to fix this product temporarily in the horizontal location.	2.2

Note: † indicates an option

Note: ‡ indicates a caster type

3.1.2 Rear

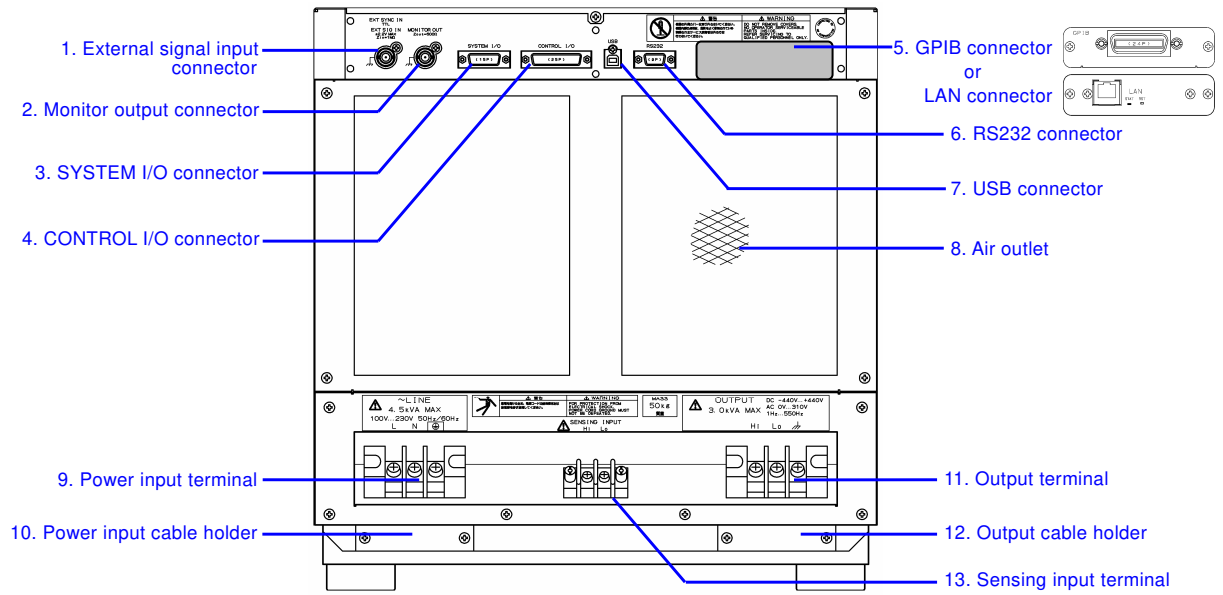

Figure 3-3 Component Name (Rear)(Foot Type)

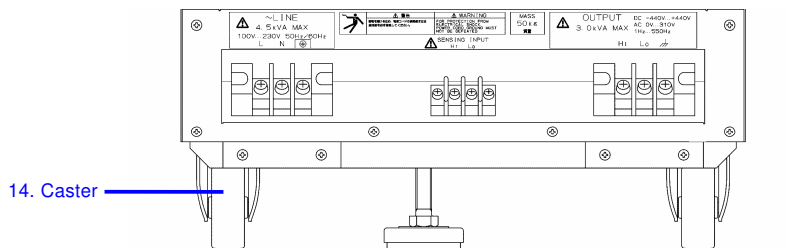

Figure 3-4 Component Name (Rear) (Caster Type)

Table 3-2 Component Name (Rear)

Number	Name	Description	Refer to
1	External signal input connector	Used when controlling the voltage value setting by the external signal (VCA), when synchronizing the output frequency with the external signal (SYNC), and when outputting the amplified external signal (EXT, ADD).	4.17, 4.19, 4.20
2	Monitor output connector	Can observe waveforms of the output voltage and output current when connected to a unit such as oscilloscopes.	4.10
3	SYSTEM I/O connector	A System Cable [†] can be connected to make a polyphase output system.	2.5.1
4	CONTROL I/O connector	Used to control this product externally by logic signal and non voltage contact. Also it can obtain the state of this product with a logic signal.	4.18
5	GPIB connector or LAN connector	GPIB or LAN communication interface. Either one can be chosen when ordering.	6.1.3, 6.1.4
6	RS232 connector	RS232 communication interface.	6.1.2
7	USB connector	USB communication interface.	6.1.1
8	Air outlet	Air outlet for exhausting the heat.	2.2
9	Power input terminal	Power input terminal.	2.4
10	Power input cable holder	Used to fix the power input cable.	2.4
11	Output terminal	Output terminal.	2.5
12	Output cable holder	Used to fix the output cable.	2.5
13	Sensing input terminal	Connect to the load end that is located in the distance from the main unit to detect its voltage.	4.11
14	Caster ^{† ‡}	Caster with the freely movable front-wheels and fixed rear-wheels. Can be used to move this product in the horizontal location.	2.3

Note: † indicates an option

Note: ‡ indicates a caster type

3.1.3 Control Panel

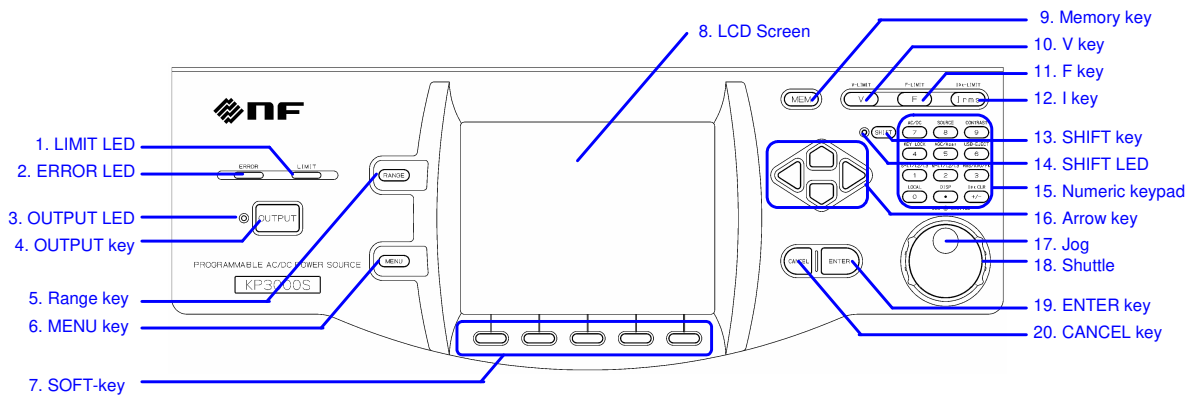

Figure 3-5 Component Name (Control Panel)

Table 3-3 Component Name (Control Panel)

Number	Name	Description	Refer to
1	LIMIT LED	Illuminates when the peak current limiter, RMS current limiter, or active wattage limiter activates.	4.1
2	ERROR LED	Illuminates when an error is detected.	8.1
3	OUTPUT LED	Illuminates in the output on state.	3.4.8
4	OUTPUT key	Turns the output on or off.	3.4.8
5	RANGE key	Switches between the 100 V and 200 V ranges.	3.4.2
6	MENU key	Displays the root menu.	3.3.1
7	Soft-key	Assigned with the functions displayed at the bottom of the LCD screen.	5.1
8	LCD screen	Displays the measured values or menu.	5.1
9	MEMORY key	Displays the Memory View.	4.8
10	V key	Opens the numerical entry box for the output voltage setting.	3.4.4, 3.4.5
11	F key	Opens the numerical entry box for the frequency setting.	3.4.6

Table 3-3 Component Name (Control Panel) (continued)

Number	Name	Description	Refer to
12	I key	Opens the RMS current limiter set window.	4.1.2
13	SHIFT key	Turns on or off the shift state, which enables Shortcut operations.	3.3.7
14	SHIFT LED	Illuminates when the shift state is turned on.	3.3.7
15	Numeric keypad	Used to enter a value directly.	3.3.5
16	Arrow key	Used to move across the items or incrementing/decrementing the value by one step.	3.3
17	Jog	Used to move across the items or incrementing/decrementing the value by one step.	3.3
18	Shuttle	Used to move across the items in the selection box or incrementing/decrementing the value. The greater the turning angle is, the faster you move or increment/decrement.	3.3
19	ENTER key	Confirms the selection.	3.3
20	CANCEL key	Returns to the previous state without confirming the selection. The numerical entry box is closed when the value was incremented or decremented using the jog, shuttle, or arrow key.	3.3

3.2 Power On/Off

3.2.1 Before Turning on the Power

This product can output AC 310 V/DC 440 V at a maximum. In a single-phase three-wire system, it can also output AC 620 V at a maximum between the wires. The wrong operations may cause the electric shock or result in malfunction of your load. Please check the following before starting operations.

- When you use this product for the first time, we recommend you to perform the test operation without any connection to the output (without loads) with the instruction manual at your side.
- Double-check the connection to the power supply. Ensure that the cable is appropriate for the input current and firmly connected.
- Double-check the connection to the output. Ensure that the cable is appropriate for the output current and firmly connected.

3.2.2 Power On

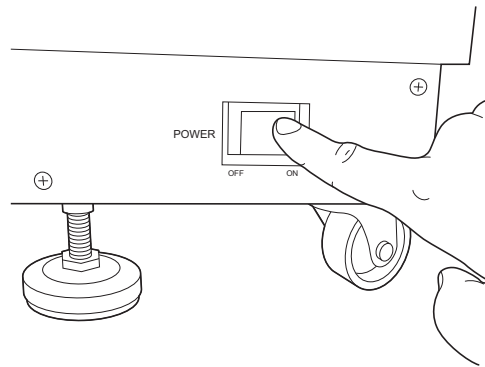

Press "On" side of the power switch. If you configured a polyphase system, all cabinets need to be turned on within 20 seconds while the order does not matter.

3.2.3 Screen Display and Operations at Starting Up

When you power on the cabinet, all LEDs in the control panel illuminate. The LEDs are lighted off after a while and the following contents are displayed in the order below.

1. The "NF" logo mark is displayed for a few seconds or more than 10 seconds. The length for which this logo is displayed depends on your system.
2. The self check is performed and the result is displayed. If any problem is detected, or if you change the polyphase system connection, the startup process halts in the self check screen shown in Figure 3-6. Check the self check result and press the ENTER key to resume the startup process.

Power On Self Test	100V	AC-INT	3P4W
	3.0k		
Model	KP3000S		
Version	1.20		
Last Adjust	2009/10/02 14:30		
ROM CHECK			OK
RAM READ/WRITE CHECK			OK
MEMORY CHECK			OK
CALIBRATION MEMORY CHECK			OK
VERSION CHECK			OK
SYSTEM CONFIGURATION CHECK			Updt
ID:68 PU-ON Setting Updated			
Press Enter Key to Continue			

Figure 3-6 The Self Check Screen to be Displayed when Starting the Unit in Other System or in Other Output Phase Configuration than before

3. Depending on the output function selection setting at power-on, the Continuous function screen, Sequence function screen, or Simulation function screen is displayed. For detailed information about the output function selection at power-on setting, see 4.2.10 and 4.3.10.

4. If the output function selection is set to the Continuous function and the output-on at power-on setting is on, the output is turned on after the confirmation message to inform that the output is automatically turned on is displayed for about 10 seconds. If you press the ENTER key while this message is displayed, you can cancel the setting of automatic output-on. For detailed information about the output-on at power-on setting, see 4.22.

3.2.4 The Settings Loaded after Startup

For the Continuous function, the output settings are invoked from the Basic Setting Memory No.1 and other settings are loaded from the System Setting Memory. For details, see 4.8 and 10.24.

For the Sequence function and the Simulation function, the factory default settings are loaded for the content of each step.

If you changed the configuration of a polyphase system, the settings are invoked depending on the output phase configuration.

3.2.5 Checking the Rated Power

On the screen after startup, the rated power icon is displayed in the position shown in Figure 3-7. The value in the icon indicates the maximum electric power that can be output. In Figure 3-7, the maximum electric power is 3.0 kVA.

If the rated power is restricted by the power unit energization setting, the icon is highlighted as shown in Table 3-4. For detailed information about the power unit energization setting, see 4.24.

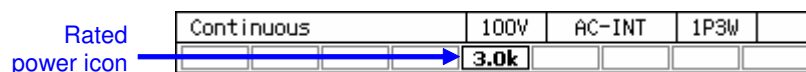

Figure 3-7 The Rated Power Icon

Table 3-4 How the Rated Power Icon is Displayed Depending on the Power Unit Energization Setting

Normal icon Example: 3.0k	All power unit energization settings are enabled. The rated power is set to the maximum value that the system and the power supply voltage can provide.
Highlighted icon Example: 1.5k	Because some power unit energization settings are disabled, the rated power is restricted.

- Notes -----
- For a polyphase system, the rated power is displayed for each phase.
-

3.2.6 Power Off

Disable the output and ensure the OUTPUT LED is off before pressing "Off" side of the power switch. All screens disappear and all LEDs turn off, then the power input and the output are blocked inside the system. For a polyphase system, although the order for turning off cabinets is not significant, a communication error message may appear if the interval between the operations of turning off the cabinets is too long. This does not cause any problem.

3.3 Basic Key Operations

3.3.1 Changing the Output Function (Continuous/Sequence/Simulation)

To change the Continuous/Sequence/Simulation function, press the MENU key. This operation displays the root menu shown in Figure 3–8.

Five icons are available in the root menu. The cursor location is informed by the highlighted icon. The description of the icon at the cursor location is displayed in the box located at the bottom of the screen. Move the cursor to the function you want to select by using arrow keys or the jog. Each icon in upper line represents the Continuous function, Sequence function, and Simulation function from the left. When you press the ENTER key, the screen for the selected function is displayed. You cannot change the function in the output on state. However, you can move to the Memory function screen or System function screen.

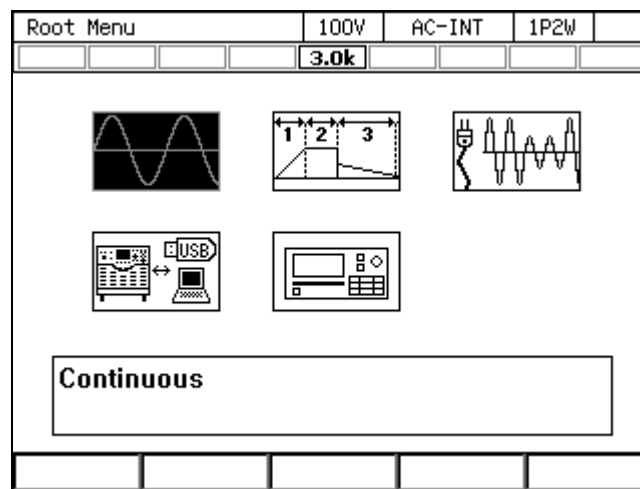



Figure 3-8 The Root Menu

3.3.2 Item Selection

You can move the cursor (highlighted icon) by using arrow keys or the jog. However, some items cannot be selected depending on your system. These items are skipped when moving the cursor. If you press the ENTER key, the item under the cursor is selected and run. If the item is a menu, the menu screen, window, or selection box is displayed. If you press the CANCEL key, the menu in the upper hierarchy is displayed without selection or execution of that item.

■ Selection box

If the menu has numbers before its menu items as shown in Figure 3–9 (selection box), pressing the corresponding number on the numeric keypad also selects and runs the item. You can also move the cursor by using the shuttle.

If you select an item with  on the right, the selection box in the lower hierarchy menu is displayed. In addition to the ENTER key, you can also use → arrow key to open the selection box of that menu.

You cannot select grayed items in a selection box, which are different depending on your setting.

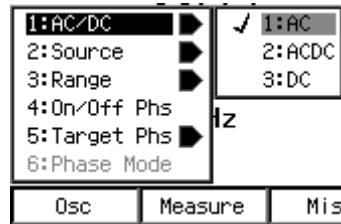

Figure 3-9 The Example of a Selection Box

■ Data list box

When selecting data in the memory, the data list box shown in Figure 3–10 is displayed. To select a data in a data list box, hover the cursor over the box by using the arrow keys or jog and press the ENTER key. This operation enables the cursor to move over each data in the data list box. Hover the cursor over the item you want to select by pressing the up or down arrow key or turning the jog or shuttle and press the ENTER key.

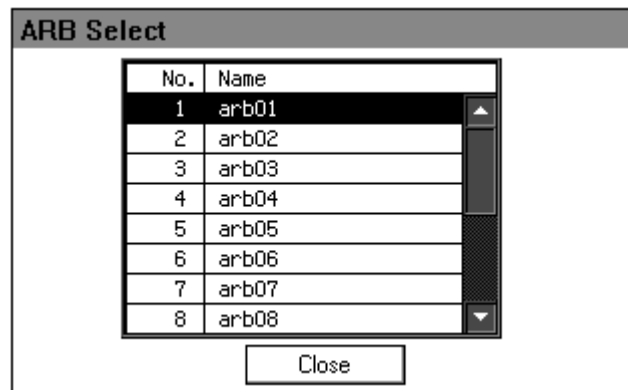

Figure 3-10 The Example of a Data List Box

3.3.3 Using Soft-keys

When the soft-key function is displayed at the bottom of the LCD screen as shown in Figure 3–11, pressing a soft-key performs the function assigned to that key.

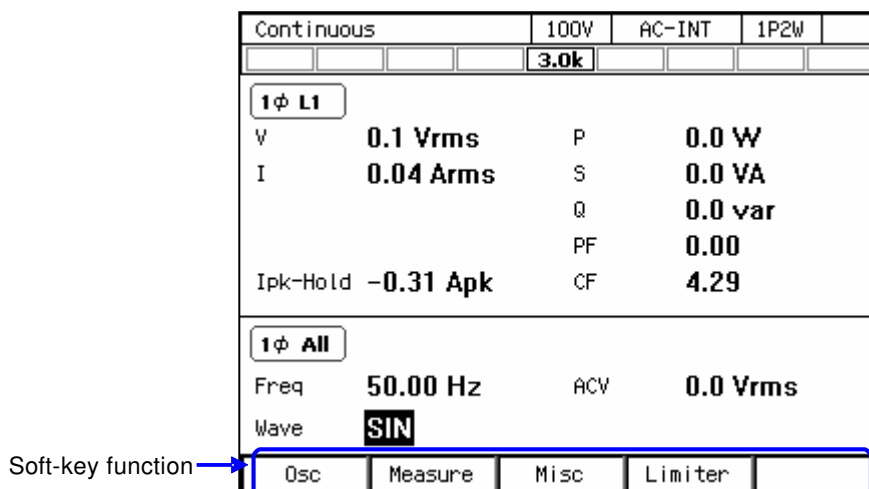

Figure 3-11 Soft-key Function

3.3.4 Closing Windows

■ The window with the [Close] button

Following three methods are available to close the window with the [Close] button shown in Figure 3-12.

- Move the cursor to the [Close] button in the window by using the arrow keys or the jog and press the ENTER key.
- Press the CANCEL key.
- Press the soft-key under the [Close] button (third button from the left).

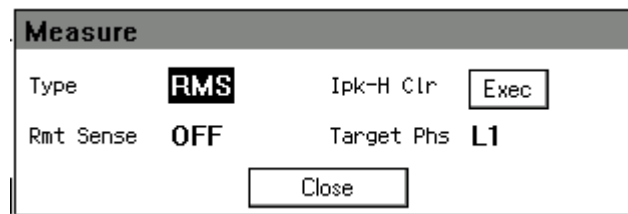

Figure 3-12 The Example of the Window with the [Close] Button

■ Window with the [OK]/[Cancel] button

Following three methods are available to close the window with the [OK]/[Cancel] button shown in Figure 3-13.

- Move the cursor to the [OK] button or [Cancel] button in the window by using the arrow keys or the jog and press the ENTER key.
- Press the CANCEL key. To do so, perform the same operation as you did to select the [Cancel] button.
- Pressing the soft-key under the [OK] button (fourth button from the left) means same as selecting the [OK] button. Similarly, pressing the soft-key under the [Cancel] button (second button from the left) means same as selecting the [Cancel] button.

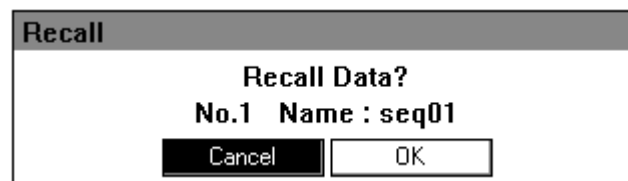

Figure 3-13 The Example of the Window with the [OK]/[Cancel] Button

3.3.5 Entering Values (Numerical Entry Box)

■ Entering values with arrow keys/jog or shuttle

For an item to set value, hover the cursor over the value (which will be highlighted) and press the ENTER key to open a numerical entry box shown in Figure 3–14 in which you can enter a value. Move to the desired digit by using the right or left arrow key and increment/decrement the value by using the up or down arrow key/the jog or shuttle. During the edit, the value is confirmed every time it is incremented or decremented. The value for the voltage or frequency output is applied even during the edit. If you press the ENTER key or the CANCEL key, the numerical entry box is closed.

■ Enter values directly by using the numeric keypad

For an item required to set values, hover the cursor over a value (which will be highlighted) and enter a new value by using the numeric keypad. A numerical entry box opens as you start entering a value, and the entered value is displayed. Press the ENTER key to confirm the value. The previous values for the voltage or frequency output are held until you press the ENTER key. If you press the CANCEL key, the settings are not changed.

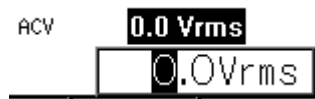

Figure 3-14 The Numerical Entry Box

----- Notes -----

- If you already know the value to set, the direct entry using the numeric keypad will be convenient.
- If you want to increment/decrement the value by one step at one time, use the up and down arrow key.
- If you want to increment/decrement the value by a large amount step by step, use the jog.
- If you want to increment/decrement the value by a large amount quickly, use the shuttle.

3.3.6 Entering Strings (Character String Entry Box)

Enter the name of the data when saving it to the internal memory or USB memory. In this case, hover the cursor over the string (which will be highlighted) and press the ENTER key. This operation opens a character string entry box shown in Figure 3-15.

When you turn the jog or press the up or down arrow key in a character string entry box, the character at the cursor (highlighted character) is changed in a way shown in Table 3-5. When you press a key in the numeric keypad, the corresponding value or symbol is entered. To move the cursor position, use the right or left arrow key. When you press the ENTER key, the edited string is confirmed and the character string entry box is closed.

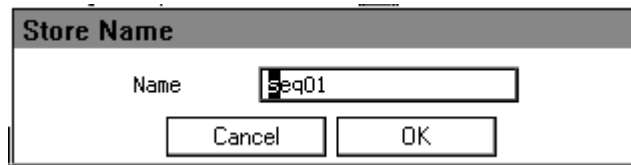

Figure 3-15 Character String Entry Box

Table 3-5 Character String Entry List

← Turning the jog in the counterclockwise direction Turning the jog in the clockwise direction
 Pressing the down arrow key Pressing the up arrow key →

ABCDEFGHIJKLMNOPQRSTUVWXYZabcdefghijklmnopqrstuvwxyz 0123456789!#\$%&'()+,-.:=@[]^_`{ }~□

(Note) □ indicates a space.

----- Notes -----

- The name of the data which will be saved in the internal memory or USB memory must be 20 characters long at a maximum.

3.3.7 Using Shortcut Operations (SHIFT Key)

When you press the SHIFT key, the SHIFT LED illuminates. In this state (shift state), pressing one of the V, F, I, and any keys in the numeric keypad enables shown in Table 3-6. In this instruction manual, pressing a key in the shift state is denoted by "**SHIFT** + X."

If you press the SHIFT key once more in the shift state, the SHIFT LED is lighted off and the shift state exits.

Notes

- The shift state is kept until you press the SHIFT key next time. Therefore, continuous Shortcut operations can be performed.
- You do not have to hold down the SHIFT key while you press another key.

Table 3-6 Shortcut Operations

Shortcut	Item	Description	Refer to
SHIFT + V	V-LIMIT	Opens the setting window for the voltage setting range limit.	4.1.3
SHIFT + F	F-LIMIT	Opens the setting window for the frequency setting range limit.	4.1.4
SHIFT + I rms	IpK-LIMIT	Opens the peak current limiter set window.	4.1.1
SHIFT + 1	S-L1/L2/L3 [†]	Switches the target phase to be configured in the following order: L1, L2, L3 (unbalanced mode), All Phase, and All Line (balanced mode).	3.4.5, 4.15
SHIFT + 2	M-L1/L2/L3 [†]	Switches the target phase of which the measured value is displayed in the following order: L1, L2, L3, L1-L2, L2-L3, L3-L1.	3.4.13
SHIFT + 3	RMS/AVG/PK [†]	Switches the display format of the measured value in the following order: RMS, AVG, PK.	3.4.10
SHIFT + 4	KEY LOCK	Enables/Disables the key lock.	4.25
SHIFT + 5	AGC/Acal	Opens the AGC/Autocal set window.	4.12, 4.13
SHIFT + 6	USB-EJECT	Performs the eject operation for removing a USB memory.	4.9
SHIFT + 7	AC/DC	Switches the AC/DC mode in the following order: AC, ACDC, DC.	3.4.1
SHIFT + 8	SOURCE	Switches the signal source in the following order: INT, VCA, SYNC, EXT, ADD.	3.4.1
SHIFT + 9	CONTRAST	Changes to the state in which the contrast is selected in the LCD set window.	4.27
SHIFT + 0	LOCAL	Exits the Remote state between the devices connected to the communication interface and enters the Local state in which the panel operations are accepted.	6.2
SHIFT + .	DISP	Switches the measured value display mode between normal and simple.	3.4.11
SHIFT + +/-	IpK CLR	Clears the current peak-hold value.	3.4.12

Note: If you change the item presented with [†] symbol using a Shortcut operations, the setting is not saved in the System Setting Memory (see 10.24).

3.4 Using the Continuous Function

3.4.1 Setting the AC/DC Mode and the Signal Source

The description of the AC/DC mode is shown in Table 3-7. The description of the signal source is shown in Table 3-8. The selectable combinations of the AC/DC mode and the signal source are shown in Table 3-9.

----- Notes -----

- If the load is a transformer whose core saturates even with small amount of DC component, select the AC mode.
- If you output AC less than 40 Hz, select the ACDC mode. You cannot set the frequency to less than 40 Hz in the AC mode.
- In the AC mode, if the output is a waveform that has a long cycle or is dissymmetric in terms of positive and negative (e.g. when the phase is changed rapidly or the different values are set for the positive and negative in the peak current limiter), the waveform may be transformed by the DC component removing function of the AC mode. If you want to make the output waveform similar to the signal source, select the ACDC mode.

Table 3-7 Description of the AC/DC Mode

AC/DC mode	Description
AC	Only the AC voltage can be set. The AC coupling is used between the signal source and the amplification section and the DC component is removed.
ACDC	The AC voltage and the DC voltage can be set respectively. The DC coupling is used between the signal source and the amplification section and both of the AC component and the DC component are output.
DC	Only the DC voltage can be set; the AC voltage is fixed to zero. The DC coupling is used between the signal source and the amplification section.

Table 3-8 The Description of the Signal Source

Signal source	Description
INT	The signal source is internal. Set the output voltage, output waveform, frequency, output on phase, and output off phase through the control panel or the remote control.
VCA	The signal source is internal. The output voltage can be controlled with the external DC input signal. The output voltage setting cannot be set through the control panel or the remote control. All conditions except for output voltage setting is same as INT.
SYNC	The signal source is internal. The frequency of the internal signal source is synchronized with the external input signal or the power line. The frequency setting cannot be set through the control panel or the remote control. All conditions except for output frequency setting is same as INT.
EXT	The signal source is external. Outputs the amplified external input signal. Set the voltage gain through the control panel or the remote control.
ADD	The signal source is the total of the external and the internal signal source. Set the voltage gain for the external input signal, output voltage for the internal signal source, output waveform, frequency, output on phase, and output off phase through the control panel or the remote control.

Table 3-9 List of the Selectable Combinations of the AC/DC Mode and the Signal Source

Output phase configuration	AC/DC mode	Signal source				
		INT	VCA	SYNC	EXT	ADD
1P2W	AC	AC-INT	AC-VCA	AC-SYNC	AC-EXT	AC-ADD
	ACDC	ACDC-INT	-	ACDC-SYNC	ACDC-EXT	ACDC-ADD
	DC	DC-INT	DC-VCA	-	-	-
1P3W	AC	AC-INT	AC-VCA	AC-SYNC	-	-
	ACDC*1	ACDC-INT	-	ACDC-SYNC	-	-
	DC	-	-	-	-	-
3P4W	AC	AC-INT	AC-VCA	AC-SYNC	-	-
	ACDC*1	ACDC-INT	-	ACDC-SYNC	-	-
	DC	-	-	-	-	-

*1: The DC voltage cannot be set in 1P3W or 3P4W of the ACDC mode.

■ Operation procedures using soft-keys

1. Press the [Osc] soft-key and select [1:AC/DC].

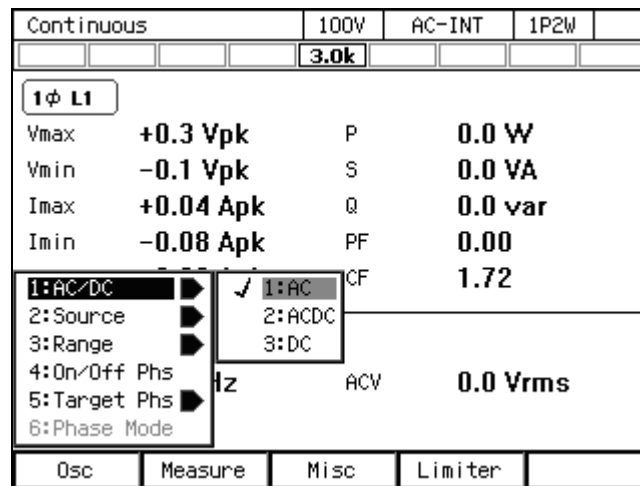

2. In the displayed selection box, select the desired AC/DC mode.

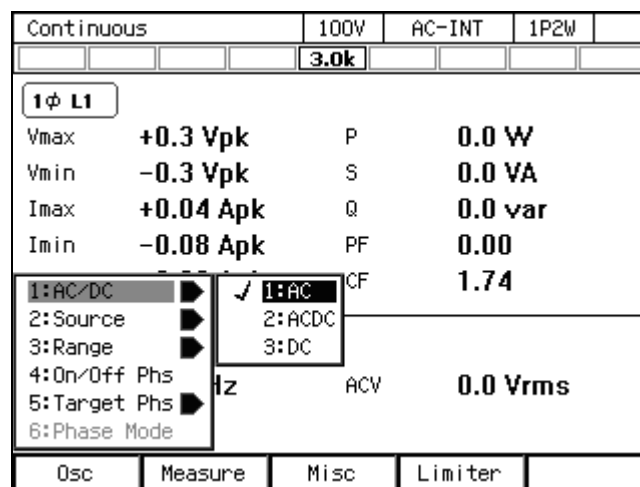

- Press the [Osc] soft-key and select [2:Source].

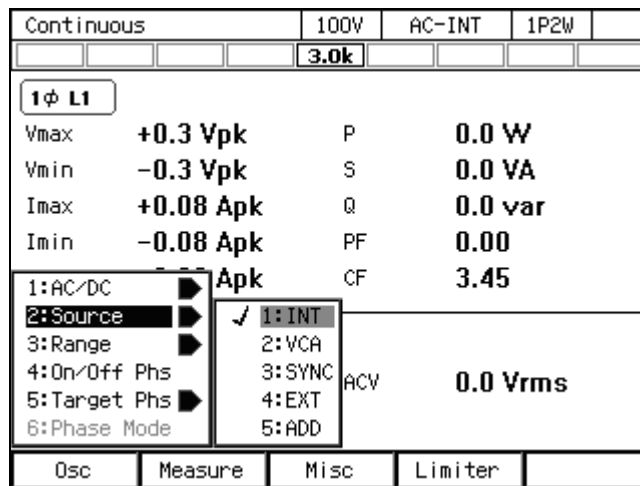

- In the displayed selection box, select the desired signal source.

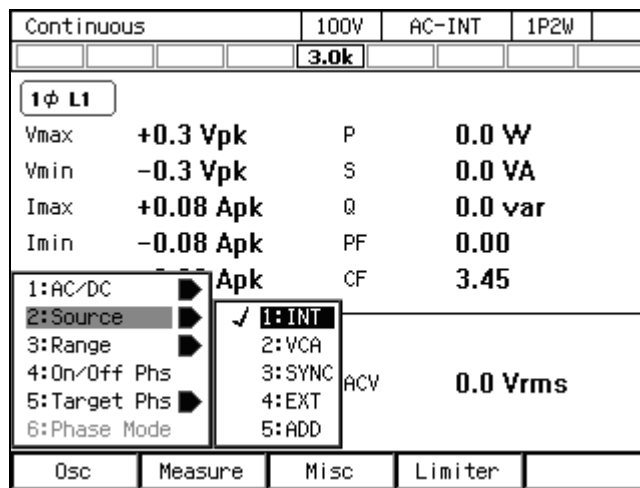

■ Operation procedures by using shortcuts

- SHIFT** + **7** Switching the AC/DC mode

Press the SHIFT key to enter the shift state (the SHIFT LED illuminates). When you press the 7 key of the numeric keypad during the shift state, the AC/DC mode is switched in the following order: AC, ACDC, DC, AC. Some modes may be skipped and cannot be selected depending on the signal source.

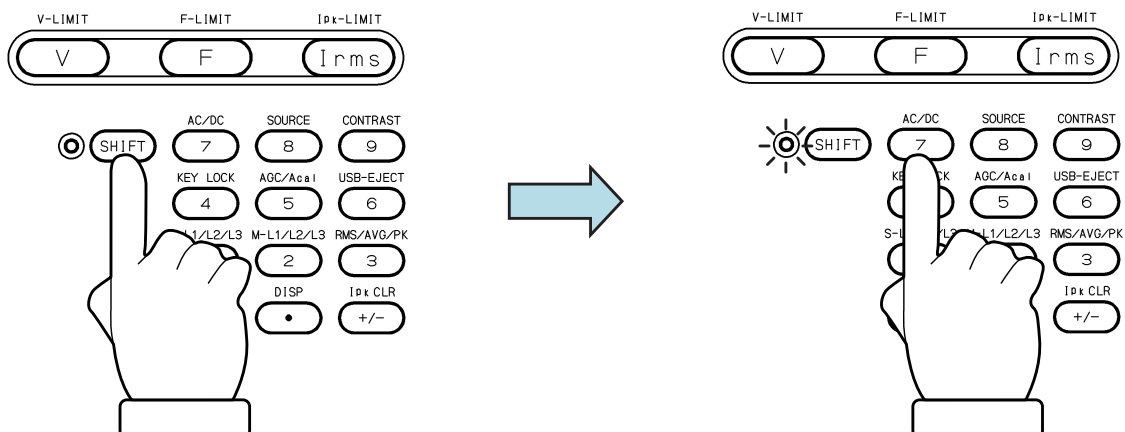

2. **SHIFT** + **8** Switching the signal source

Press the SHIFT key to enter the shift state (the SHIFT LED illuminates). When you press the 8 key of the numeric keypad during the shift state, the signal source is switched in the following order: INT, VCA, SYNC, EXT, ADD, INT. Some signal sources may be skipped and cannot be selected depending on the AC/DC mode.

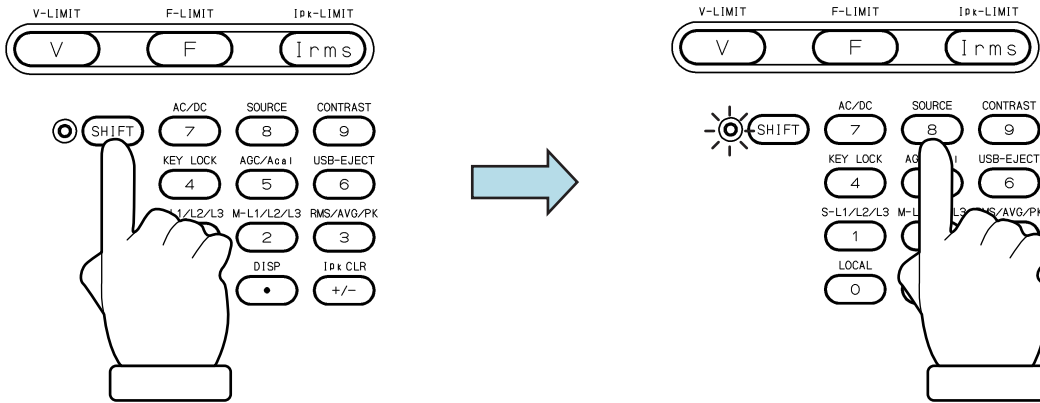

3.4.2 Setting the Output Range

You can select the 100 V range or 200 V range. Table 3-10 shows the setting range for each range.

- Notes -----
- You cannot switch the output range in the output on state.
-

Table 3-10 The Setting Range per Output Range

Setting Item				Setting Range		
				100 V range	200 V range	Unit
DC voltage				-220.0 to +220.0	-440.0 to +440.0	V
AC voltage	Phase Voltage		SIN, CLP	0.0 to 155.0	0.0 to 310.0	Vrms
			ARB	0.0 to 440.0	0.0 to 880.0	Vp-p
	Line voltage	1P3W	SIN	0.0 to 310.0	0.0 to 620.0	Vrms
		3P4W	SIN	0.0 to 268.4	0.0 to 536.8	Vrms
External Input Gain				0.0 to 220.0	0.0 to 440.0	Times
Peak current limiter (positive)				Refer to 10.13		
Peak current limiter (negative)						
RMS current limiter						
Voltage Setting Limit				Refer to 10.14		

■ Operation procedures using soft-keys

1. Press the [Osc] soft-key and select [3:Range].

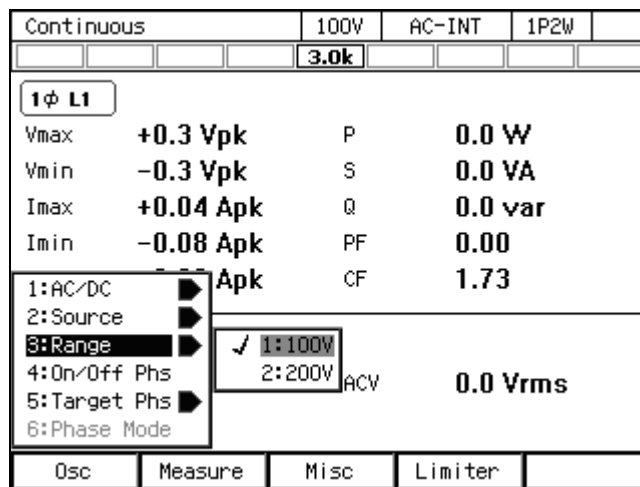

2. In the displayed selection box, select the desired output range.

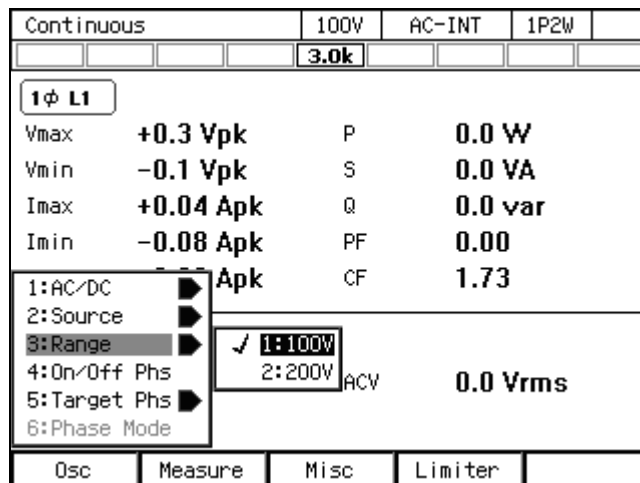

■ Operation procedures using the RANGE key

The range is toggled between 100 V range and 200 V range every time you press the RANGE key.

3.4.3 Setting Waveforms

You can select a waveform of the internal signal source from sine wave (SIN), clipped sine wave (CLP, three types available), and arbitrary waveform (ARB, 16 types available). See 4.6 for details on the clipped sine wave, and 4.7 on the arbitrary waveform.

Notes

- The AC voltage setting (ACV) is common between SIN and CLP, but ARB is independent of these. When you switch the waveform selection among SIN, CLP, and ARB, the AC voltage setting is also switched. The DC output voltage setting (DCV) is same regardless of the waveform setting.
- The waveform can be changed in the output on state, but the AC output voltage setting (ACV) is also switched as described above if you switch the waveform selection between SIN, CLP, and ARB. Set ACVs for SIN, CLP, and ARB in the output off state before you change the waveform in the output on state.

■ Operation procedure

1. Select the [Wave] item.

Continuous		100V	AC-INT	1P2W
		3.0k		
1φ L1				
Vmax	+0.3 Vpk	P	0.0 W	
Vmin	-0.1 Vpk	S	0.0 VA	
Imax	+0.04 Apk	Q	0.0 var	
Imin	-0.08 Apk	PF	0.00	
Ipk-Hold	-0.08 Apk	CF	1.73	
1φ All				
Freq	50.00 Hz	ACV	0.0 Vrms	
Wave	SIN			
Osc	Measure	Misc	Limit	

2. In the displayed selection box, select the desired waveform (SIN, CLP, ARB).

Continuous		100V	AC-INT	1P2W
		3.0k		
1φ L1				
Vmax	+0.3 Vpk	P	0.0 W	
Vmin	-0.3 Vpk	S	0.0 VA	
Imax	+0.04 Apk	Q	0.0 var	
Imin	-0.08 Apk	PF	0.00	
Ipk-Hold	0.08 Apk	CF	1.73	
1φ All				
Freq	50.00 Hz	ACV	0.0 Vrms	
Wave	SIN			
Osc	Measure	Misc	Limit	

3. If you select CLP or ARB, the [Select] icon (**Select**) is displayed next to it. When you move the cursor onto the [Select] icon, the clip ratio or crest factor is displayed for the clipped sine wave, or the arbitrary waveform data name for the arbitrary waveform. When you press the ENTER

key, the setting window opens for the clipped sine wave or the selection window opens for the arbitrary waveform. In this window, set or select items as needed.

Continuous		100V	AC-INT	1P2W
		3.0k		
1φ L1				
Vmax	+0.3 Vpk	P		0.0 W
Vmin	-0.3 Vpk	S		0.0 VA
I _{max}	+0.04 Apk	Q		0.0 var
I _{min}	-0.08 Apk	PF		0.00
I _{pk-Hold}	-0.08 Apk	CF		1.71
1φ All				
Freq	50.00	90.0 %	ACV	0.0 Vrms
Wave	CLP	Select		
Osc	Measure	Misc	Limiter	

3.4.4 Setting the Output Voltage (Single-phase Output)

Set the AC component and DC component separately for the output voltage of the internal signal source. For the AC component, set the output voltage in the ACV item. For the DC component, set it in the DCV item.

----- Notes -----

- The output voltage setting is common between SIN and CLP, but ARB is independent of these. When you switch the waveform setting among SIN, CLP, and ARB, the output voltage setting is also switched.
- In the ACDC mode, the voltage setting range limit is applied to the additional values of the AC voltage setting (recalculated to a peak value) and the DC voltage setting. For details, see 4.1.3.

■ Operation procedures for setting the AC voltage

1. Select the [ACV] item and then enter a numeric value. For how to enter values, see 3.3.5.

Continuous		100V	AC-INT	1P2W
		3.0k		
1φ L1				
V	0.1 Vrms	P		0.0 W
I	0.02 Arms	S		0.0 VA
		Q		0.0 var
		PF		0.00
I _{pk-Hold}	-0.08 Apk	CF		3.50
1φ All				
Freq	50.00 Hz		ACV	100.0 Vrms
Wave	SIN			80.0Vrms
Osc	Measure	Misc	Limiter	

Notes

- Set the RMS values for the voltages of the sine wave (SIN) and the clipped sine wave (CLP) and the Peak-to-Peak value for the voltage of the arbitrary waveform (ARB).

■ Operation procedures for setting the DC voltage

1. Select the [DCV] item and then enter a numeric value. For how to enter values, see 3.3.5.

Continuous		100V	ACDC-INT	1P2W
		3.0k		
1φ L1				
V	0.1 Vrms	P	0.0 W	
I	0.02 Arms	S	0.0 VA	
		Q	0.0 var	
		PF	0.00	
Ipk-Hold	-0.08 Apk	CF	3.44	
1φ All				
Freq	50.00 Hz	ACV	+30.0V	
Wave	SIN	DCV	+0.0 V	
Osc	Measure	Misc	Limiter	

3.4.5 Setting the Output Voltage (Polyphase Output)

This section describes the operations in the balanced mode in a polyphase system. In the balanced mode, the phase voltage and the line voltage are set for all phases at once. To enter the balanced mode, select the [Osc] soft-key → [6: Phase Mode] to open the phase mode set window, and select [1:Balance] in the Mode item. For details on the unbalanced mode, see 4.15.

■ Operation procedures for setting the phase voltage

1. Check the icon in the output display area (see 5.1) is **2φ All** (single-phase three-wire system) / **3φ All** (three-phase system). If the different icon is shown, press the [Osc] soft-key and select [5:Target Phs] → [4:All Phs]. Or perform the Shortcut operation **SHIFT** + **1** to switch to [All Phs].

Continuous		100V	AC-INT	3P4W
		3.0k		
3φ L1				
V	0.1 Vrms	P	0.0 W	
I	0.02 Arms	S	0.0 VA	
		Q	0.0 var	
		PF	0.00	
			3.50	
1:AC/DC	▶	1:L1		
2:Source	▶	2:L2		
3:Range	▶	3:L3		
4:On/Off Phs	▶	✓ 4:All Phs		
5:Target Phs	▶	5:All Line		
6:Phase Mode	▶			
			0.0 Vrms	
Osc	Measure	Misc	Limiter	

2. Select the [ACV] item and then enter a numeric value. For how to enter values, see 3.3.5.

Continuous		100V	AC-INT	3P4W
		3.0k		
3φ L1				
V	0.1 Vrms	P	0.0 W	
I	0.02 Arms	S	0.0 VA	
		Q	0.0 var	
		PF	0.00	
Ipk-Hold	-0.08 Apk	CF	3.50	
3φ All				
Freq	50.00 Hz	ACV	0.0 Vrms	
Wave	SIN		100.0Vrms	
Osc	Measure	Misc	Limiter	

■ Operation procedures for setting the line voltage

1. Press the [Osc] soft-key and select [5:Target Phs] → [5:All Line]. Or perform the Shortcut operation (SHIFT) + (1) to switch to [All Line]. Check that the icon in the output display area (see 5.1) is **2φ Line** (single-phase three-wire system)/**3φ Line** (three-phase system).

Continuous		100V	AC-INT	3P4W																								
		3.0k																										
3φ L1																												
V	0.1 Vrms	P	0.0 W																									
I	0.02 Arms	S	0.0 VA																									
		Q	0.0 var																									
		PF	0.00																									
Ipk-Hold	-0.08 Apk	CF	3.51																									
<table border="0"> <tr> <td>1:AC/DC</td> <td>▶</td> <td>1:L1</td> <td></td> </tr> <tr> <td>2:Source</td> <td>▶</td> <td>2:L2</td> <td></td> </tr> <tr> <td>3:Range</td> <td>▶</td> <td>3:L3</td> <td></td> </tr> <tr> <td>4:On/Off Phs</td> <td>▶</td> <td>✓ 4:All Phs</td> <td></td> </tr> <tr> <td>5:Target Phs</td> <td>▶</td> <td>5:All Line</td> <td></td> </tr> <tr> <td>6:Phase Mode</td> <td></td> <td></td> <td></td> </tr> </table>					1:AC/DC	▶	1:L1		2:Source	▶	2:L2		3:Range	▶	3:L3		4:On/Off Phs	▶	✓ 4:All Phs		5:Target Phs	▶	5:All Line		6:Phase Mode			
1:AC/DC	▶	1:L1																										
2:Source	▶	2:L2																										
3:Range	▶	3:L3																										
4:On/Off Phs	▶	✓ 4:All Phs																										
5:Target Phs	▶	5:All Line																										
6:Phase Mode																												
			0.0 Vrms																									
Osc	Measure	Misc	Limiter																									

2. Select the [ACV] item and then enter a numeric value. For how to enter values, see 3.3.5.

Continuous		100V	AC-INT	3P4W
		3.0k		
3φ L1				
V	0.1 Vrms	P	0.0 W	
I	0.02 Arms	S	0.0 VA	
		Q	0.0 var	
		PF	0.00	
Ipk-Hold	-0.08 Apk	CF	3.47	
3φ Line				
Freq	50.00 Hz	ACV	0.0 Vrms	
Wave	SIN		200.0Vrms	
Osc	Measure	Misc	Limiter	

Notes

- The line voltage can be set only for the sine wave in the balanced mode.

3.4.6 Setting the Output Frequency

Set the AC component frequency of the internal signal source.

■ Operation procedure

1. Select the [Freq] item and follow the instructions in 3.3.5 to enter a value.

Continuous	100V	AC-INT	1P2W	
	3.0k			
1φ L1				
V	0.1 Vrms	P	0.0 W	
I	0.02 Arms	S	0.0 VA	
		Q	0.0 var	
		PF	0.00	
Ipk-Hold	-0.08 Apk	CF	3.44	
1φ All				
Freq	50.00 Hz	ACV	100.0 Vrms	
Wave	60.00Hz			
Osc	Measure	Misc	Limiter	

3.4.7 Setting the Output On/Off Phase

Set the phases when the output turns on/off. After the output-on operation, the voltage output is started from the output on phase. After the output off operation, the voltage output is completed when it reaches the output off phase. The output off phase can be disabled. If disabled, the output is turned off immediately after the operation of output off.

■ Operation procedure

1. Press the [Osc] soft-key and select [4:On/Off Phs]. The output on/off phase setting window opens.

Continuous	100V	AC-INT	1P2W	
	3.0k			
1φ L1				
V	0.1 Vrms	P	0.0 W	
I	0.02 Arms	S	0.0 VA	
		Q	0.0 var	
		PF	0.00	
		CF	3.47	
<div style="display: flex; align-items: center;"> <div style="border: 1px solid black; padding: 2px; margin-right: 5px;"> 1: AC/DC 2: Source 3: Range 4: On/Off Phs 5: Target Phs 6: Phase Mode </div> <div style="margin-left: 10px;"> Apk Iz </div> </div>				
		ACV	100.0 Vrms	
Osc	Measure	Misc	Limiter	

- Set the on and off phase in the [On Phase] item and [Off Phase] item respectively. If you want to disable the off phase, select [Disable].

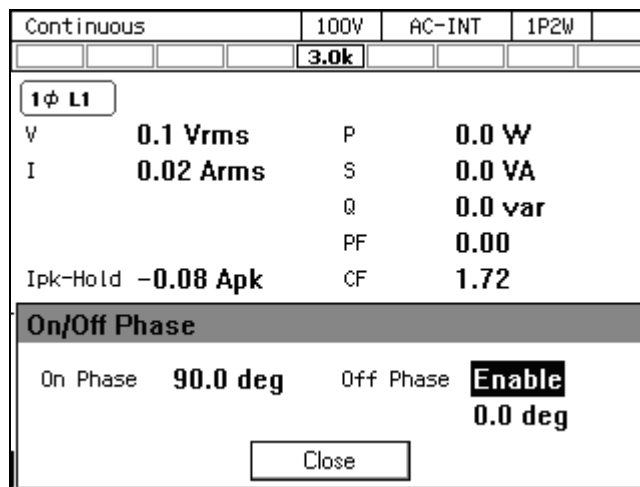

- Close the window. For how to close the window, see 3.3.4.

----- Notes -----

- The output on/off phase setting is invalid for the Sequence and the Simulation.

3.4.8 Turning the Output On or Off

Use the OUTPUT key to turn the output on or off. The OUTPUT LED illuminates in the output on state.

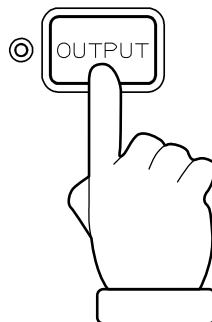

----- Notes -----

- For how to turn the output on or off rapidly, see 4.21.

3.4.9 Using the Measurement Function

The measured values are displayed in the measured value area (see 5.1). The main measurement functions of this product are shown in Table 3-11. For details of the display items of the measured value, see 5.1.2.

Table 3-11 Main Measurement Functions

Item		Description	Unit
V	Output voltage effective value	The effective (RMS) value of the output voltage on the output terminal.	Vrms
Vavg	Output voltage average value	The average DC value of the output voltage on the output terminal.	V
Vmax	Output voltage maximum peak value	The maximum peak value of the output voltage on the output terminal.	Vpk
Vmin	Output voltage minimum peak value	The minimum peak value of the output voltage on the output terminal.	Vpk
I	Output RMS current	The effective (RMS) value of the output current. When the line voltage display is L1-L2/L2-L3/L3-L1, the phase current of the L1/L2/L3 phase is displayed respectively.	Arms
Iavg	Output current average value	The average DC value of the output current.	A
Imax	Output current maximum peak value	The maximum peak value of the output current. When the line voltage display is L1-L2/L2-L3/L3-L1, the phase current of the L1/L2/L3 phase is displayed respectively.	Apk
Imin	The minimum peak value of the output current	The minimum peak value of the output current. When the line voltage display is L1-L2/L2-L3/L3-L1, the phase current of the L1/L2/L3 phase is displayed respectively.	Apk
Ipk-Hold	Output current peak-hold value	The hold value of Imax or Imin, either of which the value is bigger. When the line voltage display is L1-L2/L2-L3/L3-L1, the phase current of the L1/L2/L3 phase is displayed respectively.	Apk
P	Active power	The active power provided to the load. The power of the phase is displayed when in the phase voltage display. The total power of all phases is displayed when in the line voltage display.	W
S	Apparent power	The apparent power provided to the load. The power of the phase is displayed when in the phase voltage display. The total power of all phases is displayed when in the line voltage display.	VA
Q	Reactive power	The reactive power provided to the load. The power of the phase is displayed when in the phase voltage display. The total power of all phases is displayed when in the line voltage display.	var

Table 3-11 Main Measurement Functions (continued)

Item		Description	Unit
PF	Power factor	The power factor of the load. The power factor of the phase is displayed when in the phase voltage display in the polyphase system. It is not displayed when in the line voltage display.	—
CF	Crest factor	The crest factor of the output current (peak value/effective value). It is not displayed for the line voltage display in the polyphase system.	—
F	Synchronization frequency	The measured frequency value of the synchronization signal source when the signal source is SYNC.	Hz

3.4.10 Switching the Display Format (RMS/AVG/Peak) of the Measured Value

You can switch the display format of the measured value (RMS/AVG/Peak) for the output voltage and output current. The items which are displayed in each measuring mode are shown in Table 3-12.

Table 3-12 The Measuring Mode for the Measured Values of the Output Voltage and Output Current

Measuring mode	Items to be Displayed (Output Voltage, Output Current)
RMS	V, I, Ipk-Hold
AVG	Vavg, Iavg, Ipk-Hold
Peak	Vmax, Vmin, Imax, Imin, Ipk-Hold

■ Operation procedures using soft-keys

1. Press the [Measure] soft-key and select [2:Measure]. The [Measure] window opens.

Continuous	100V	AC-INT	1P2W
	3.0k		
1φ L1			
V	0.1 Vrms	P	0.0 W
I	0.02 Arms	S	0.0 VA
		Q	0.0 var
		PF	0.00
Ipk-Hold	-0.08 Apk	CF	3.44
1φ All			
Freq		ACV	100.0 Vrms
Wave			
Osc	Measure	Misc	Limiter

- Select the [Type] item. In the displayed selection box, select the desired measuring mode.

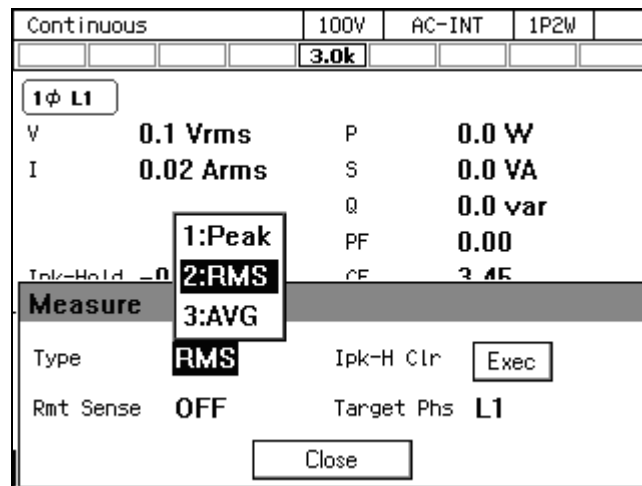

- Close the window. For how to close the window, see 3.3.4.

■ Operation procedures by using shortcuts

- SHIFT**+**3** Switching the display format of the measured values

Press the SHIFT key to enter the shift state (the SHIFT LED illuminates). When you press the 3 key of the numeric keypad during the shift state, the measuring mode is switched in the following order: RMS, AVG, Peak, RMS. Some measuring modes may be skipped and cannot be selected depending on the AC/DC mode.

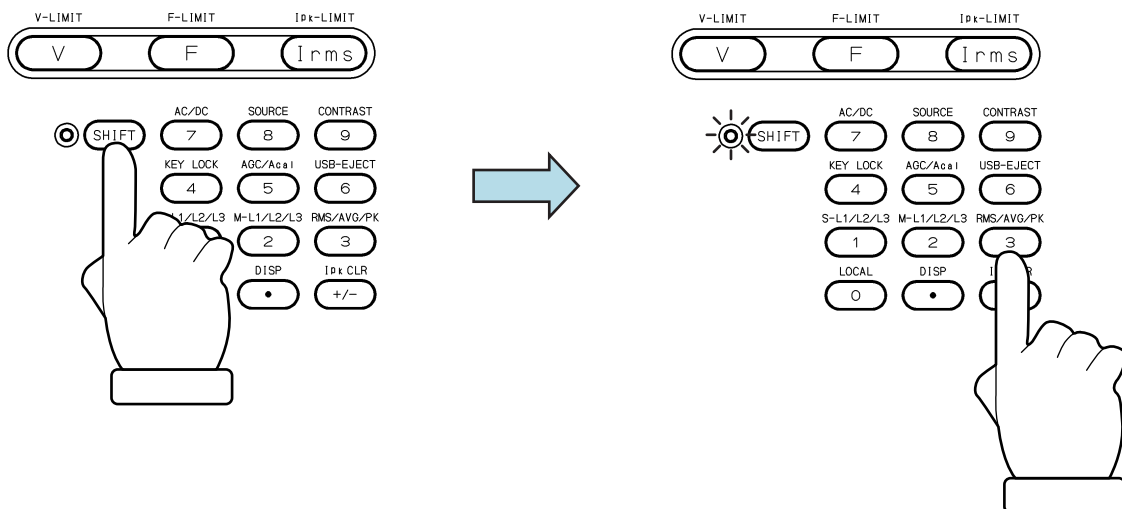

3.4.11 Enlarge Display Letters for the Measured Value

You can switch the measured value display mode between normal (normal) and the mode in which the letters are enlarged (simple) shown in Figure 3–16. In the Simple View mode, three types of measured values are displayed. You can select the measured value being displayed in the Simple View mode.

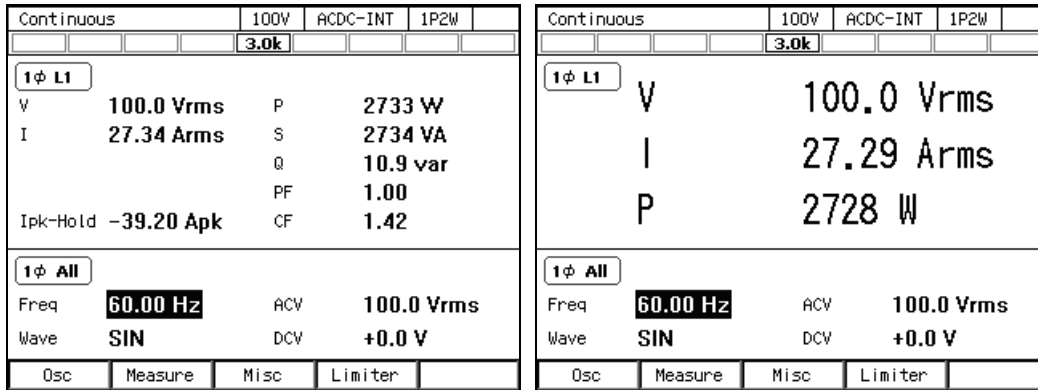

Figure 3-16 The Normal View (left) and the Simple View Mode (right)

Notes

- If the measured value display mode is changed to Peak in the Simple View mode, the maximum peak values (Vmax/Imax) are displayed instead of the voltage/current measured value. Also, if the measured value display mode is changed to RMS/AVG from Peak, the effective/average values are displayed instead of the maximum and minimum peak values.
- If the AC/DC mode and the signal source are changed in the Simple View mode, the measured voltage values are forced to be displayed instead of the items that are not displayed in the mode after the change, such as the power factor or crest factor. If this operation is applied to multiple items, the measured current value is displayed for the second item, and the current peak-hold value for the third.

■ Switching the measured value display mode (normal/simple)

The mode is toggled between normal and simple every time you perform the Shortcut operation with **SHIFT** + **•**. You can also change the mode by following the steps below.

1. Press the [Measure] soft-key and select [1:Mode].
2. Select 1: Normal/2: Simple.

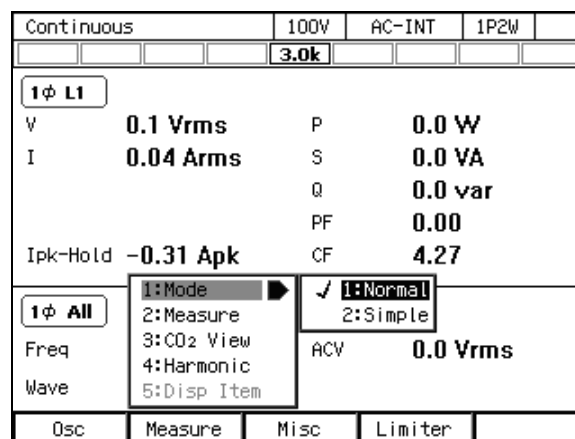

■ Selecting the measured value being displayed in the Simple View mode (procedure 1)

1. In the Simple View mode, press the [Measure] soft-key and select [5:Disp Item]. The setting window for display items opens.

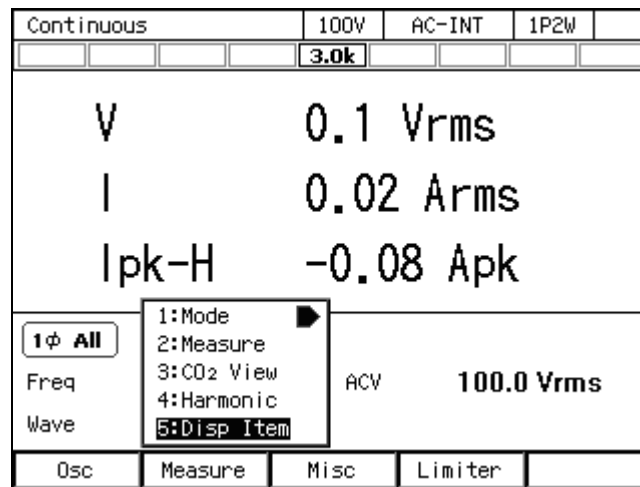

2. In the [Item1] to [Item3] items, select measured values to be displayed.

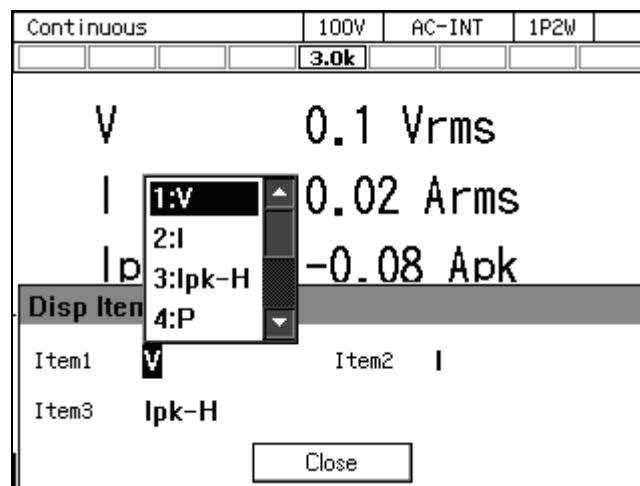

3. Close the window. For how to close the window, see 3.3.4.

- Selecting the measured value being displayed in the Simple View mode (procedure 2)

In the Simple View mode, hover the cursor over the measured value item and press the ENTER key. The selection box for choosing display items opens.

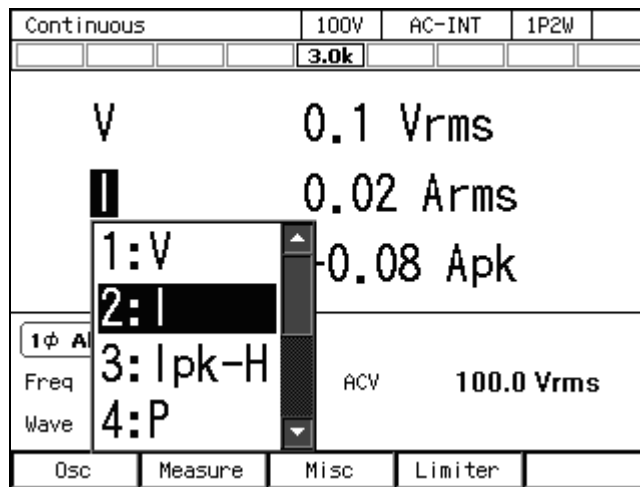

3.4.12 Clearing the Output Current Peak-hold Value

The output current peak-hold value is the maximum absolute value of the measured output current peak value, which is then updated appending signs and held. This held value can be cleared. After the held value is cleared, it is updated with the value measured after that. The held value is cleared when the power is turned off.

- Operation procedures using soft-keys

1. Press the [Measure] soft-key and select [2:Measure]. The [Measure] window opens.

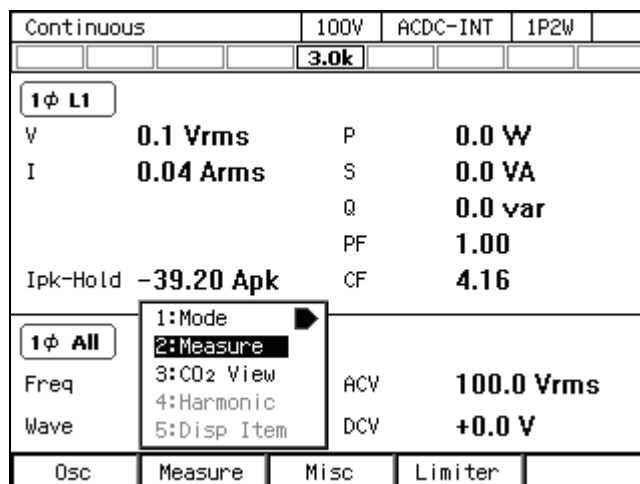

2. Move the cursor to [Exec] of the [Ipk-H Clr] item and press the ENTER key.

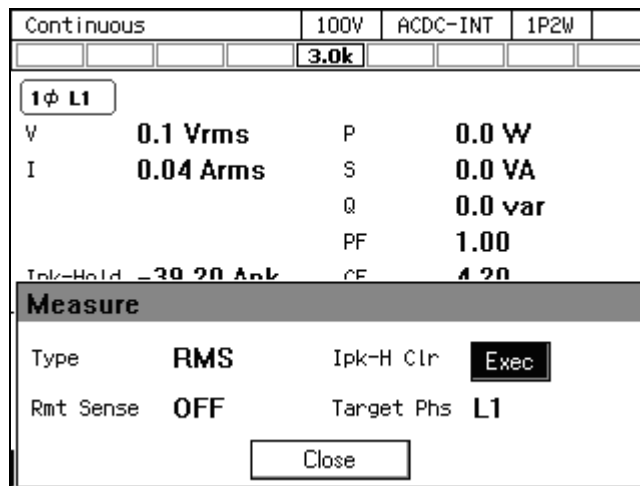

3. Close the window. For how to close the window, see 3.3.4.

■ Operation procedures by using shortcuts

1. **SHIFT** + **+/-** Clearing the current peak-hold value

Press the SHIFT key to enter the shift state (the SHIFT LED illuminates). When you press the +/- key in the numeric keypad in the shift state, the output current peak-hold value is cleared.

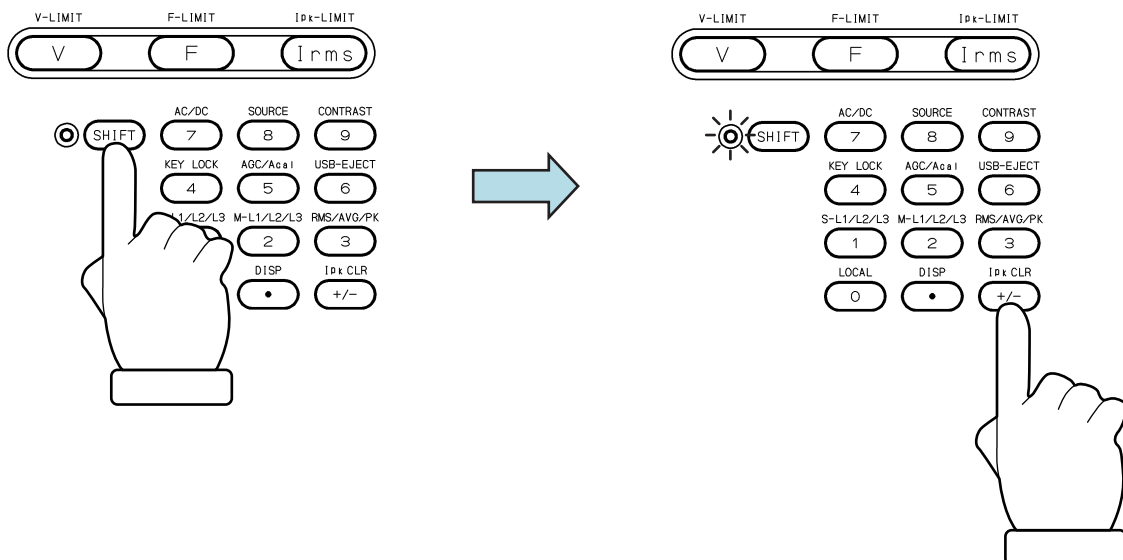

3.4.13 Switching the Target Phase of which the Measured Values are Displayed (Polyphase Output)

You can switch the phase of which the measured values are displayed on the LCD screen of L1 cabinet in the polyphase system. You can select the line voltage display.

----- Notes -----

- Even if the line voltage display is selected, the phase voltage is displayed when Peak is selected for the measuring mode. If L1-L2, L2-L3, or L3-L1 is selected, the maximum and minimum peak values of the phase voltage for L1, L2, or L3 is displayed respectively.
- The line voltage display (RMS display) is not the line voltage value that is measured directly. This is the value that is calculated based on the phase setting value and the measured phase voltage value.
- In the line voltage display, the measured output current value indicates the phase current. If L1-L2, L2-L3, or L3-L1 is selected, measured values of the phase current for L1, L2, L3 is displayed.
- In the line voltage display, the power factor and crest factor are not displayed.
- In the line voltage display, the measured output power value indicates the output power of the phase when in the phase voltage display, and total output power of all phases when in the line voltage display.

■ Operation procedures using soft-keys

1. Press the [Measure] soft-key and select [2:Measure]. The [Measure] window opens.

Continuous		100V	AC-INT	3P4W
		3.0k		
3φ L1				
V	0.1 Vrms	P	0.0 W	
I	0.01 Arms	S	0.0 VA	
		Q	0.0 var	
		PF	0.14	
Ipk-Hold	-0.08 Apk	CF	3.67	
3φ All		1:Mode 2:Measure 3:CO2 View 4:Harmonic 5:Disp Item		
Freq		ACV	0.0 Vrms	
Wave				
Osc	Measure	Misc	Limiter	

- In the [Target Phs] item, select the phase of which the measured value is to be displayed. For the line voltage, select L1-L2, L2-L3, or L3-L1.

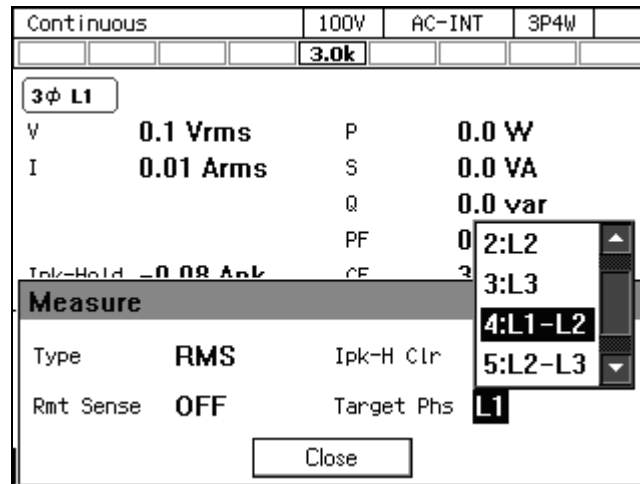

- Close the window. For how to close the window, see 3.3.4.

■ Operation procedures by using shortcuts

- SHIFT**+**2** Switches the target phase of which the measured value is displayed

Press the SHIFT key to enter the shift state (the SHIFT LED illuminates). When you press the 2 key in the numeric keypad in the shift state, the phase is switched in the order of L1→L2→L1-L2→L1 ... in the single-phase three-wire. In the three-phase, it is switched in the order of L1→L2→L3→L1-L2→L2-L3→L3-L1→L1 ...

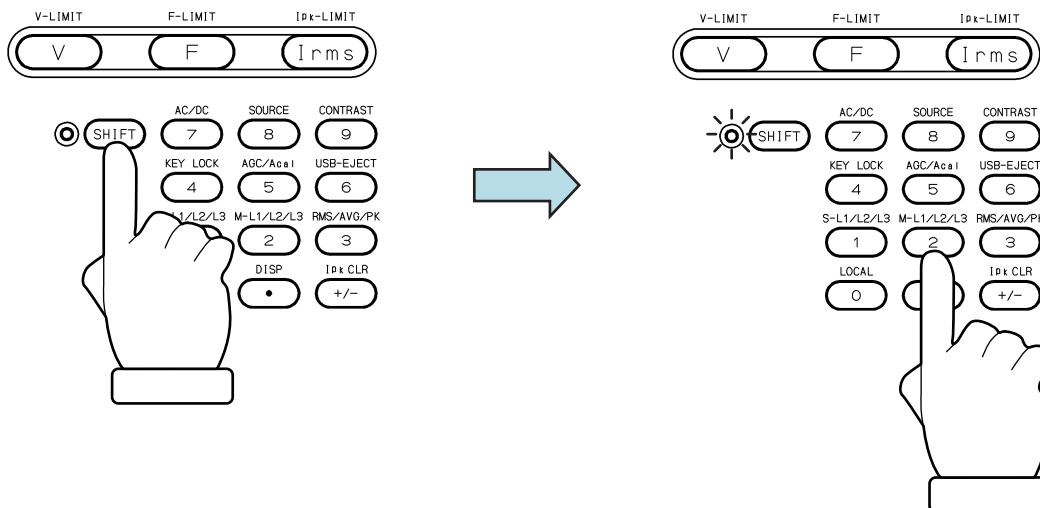

4. Advanced Operation

4.1	Using Limiter, Setting Limiter	62
4.2	Using Sequence Function	69
4.3	Using Power Fluctuation Testing (Simulation) Function	99
4.4	Measuring Harmonic Current	123
4.5	Measuring Inrush Current	125
4.6	Using Clipped Sine Wave	127
4.7	Outputting Arbitrary Waveform	130
4.8	Using Memory Function	135
4.9	Using USB Memory Function	149
4.10	Using Monitor Function	150
4.11	Using Remote Sensing Function	153
4.12	Using AGC Function	155
4.13	Using Autocal Function	158
4.14	Adjusting DC Offset	162
4.15	Using for Unbalanced Polyphase Output	164
4.16	Using as DC Power Supply	166
4.17	Setting Voltage using External DC Input Signal	167
4.18	Control Using External Control Function	171
4.19	Synchronizing the Output Frequency with the Power Line or the External Signal	176
4.20	Amplifying the External Signal Input	178
4.21	Turning the Output On or Off Rapidly	179
4.22	Enabling Automatic Output-On at Power-On	181
4.23	Using the Emission CO ₂ Calculator	182
4.24	Power Unit Energization Setting (Using Under the Restricted Rated Power)	184
4.25	Key Lock	186
4.26	Beep	186
4.27	Changing the Background Color and the Contrast of the Screen	187
4.28	Restoring to the Factory Default Setting (Reset)	188

4.1 Using Limiter, Setting Limiter

4.1.1 Use Peak Current Limiter

Peak value of output current is limited by the peak current limiter. While the limiter is working, icon  is displayed and LIMIT LED illuminates.

Setting values of peak current limiter are variable, and kept independently for each of 100 V and 200 V ranges.



You can choose whether to make the output off or not upon the triggering of the peak current limiter. If you choose to set the output off, specify the continuous operation time of limiter until the output off becomes effective. Whether output off is set or not and the time setting are common regardless of the output ranges.

For the default setting range, see 10.13.

----- Notes -----

- Output current value may be limited by a value that is different from the setting value, depending on the load.
- For an inductive load, overvoltage protection may be triggered due to the operation of peak current limiter. Overvoltage protection may be avoided by lowering the limiter setting value both for negative and positive values.
- When the number of power units that are energized is increased or decreased based on the power unit energization setting, the setting values of the peak current limiter are reset to the factory default setting corresponding to the ratings output power.
- In the polyphase system, the setting of the peak current limiter is common to all phases.
- If the output off after the continuous operation of the limiter for the specified duration is enabled, the setting of output-off phase is ignored.
- In the case that the peak current limiter operates when the setting value of the peak current limiter is set as asymmetry between positive and negative in the AC mode, the DC component is generated in the output. Although the function to remove the DC component of the output works in the AC mode, when the peak current limiter operates intermittently, the DC component may not be removed sufficiently, or the output waveform may be modified.

■ Operation procedure

1. Push [Limiter] soft-key to select 1: Ipk Limiter (or push  + ). Opens the peak current limiter set window.

Continuous		100V	AC-INT	1P2W
		3.0k		
1ϕ L1				
V	0.1 Vrms	P	0.0 W	
I	0.02 Arms	S	0.0 VA	
		Q	0.0 var	
		PF	0.00	
Ipk-Hold	-0.08 Apk	CF	3.43	
1ϕ All				
Freq	50.00 Hz	ACV	1:Ipk Limiter	
Wave	SIN		2:Irms Limiter	
			3:V/F Limiter	
Osc	Measure	Misc	Limiter	

2. In the [+Iop]/[-Iop] item, set the peak current limiter value of positive/negative.

Continuous		100V	AC-INT	1P2W
		3.0k		
1ϕ L1				
V	0.1 Vrms	P	0.0 W	
I	0.02 Arms	S	0.0 VA	
		Q	0.0 var	
		PF	0.00	
Ipk Limiter				
+Iop	63.0 Apk			
-Iop	-63.0 Apk			
Output OFF	Disable			
Close				

3. Set the [Output OFF] item as [Enable] or [Disable]. When setting to [Enable], also set the time from the start of limiter operation to the output off.

Continuous		100V	AC-INT	1P2W
		3.0k		
1ϕ L1				
V	0.1 Vrms	P	0.0 W	
I	0.02 Arms	S	0.0 VA	
		Q	0.0 var	
		PF	0.00	
Ipk Limiter				
+Iop	1:Disable			
-Iop	2:Enable			
Output OFF	Disable			
Close				

4. Close the window.

4.1.2 Using RMS Current Limiter

Effective value of output current is limited by the RMS current limiter. While the limiter is working, icon  is displayed and LIMIT LED illuminates.

Setting values of RMS current limiter are variable, and kept independently for each of 100 V and 200 V ranges.

You can choose whether to make the output off or not upon the triggering of the RMS current limiter. If you choose to set the output off, specify the continuous operation time of limiter until the output off becomes effective. Whether output off is set or not and the time setting are common regardless of the output ranges.

For the default setting range, see *10.13*.

Notes

- It will take time from the limiter starts operation until the output current is restricted enough, because the RMS current limiter needs to calculate effective value. Use the peak current limiter to limit the current quickly. For peak current limiter, see *4.1.1*.
- When the number of units is increased or decreased based on the power unit energization setting, the setting is reset to the factory default setting corresponding to the capacity.
- In the polyphase system, the setting of the RMS current limiter is common to all phases.
- If the output off after the continuous operation of the limiter for the specified duration is enabled, the setting of output-off phase is ignored.

CAUTION

- For loads with very low impedance (e.g. output short circuit, etc.), the RMS current limiter cannot sufficiently limit the output current and may exceed the rated current. Use within the rated current range by checking the current measured value and using the peak current limiter together etc.
-

■ Operation procedure

1. Push [Limiter] soft-key to select 2:Irms Limiter (or push I key). Opens the RMS current limiter set window.

Continuous		100V	AC-INT	1P2W
		3.0k		
1φ L1				
V	0.1 Vrms	P	0.0 W	
I	0.03 Arms	S	0.0 VA	
		Q	0.0 var	
		PF	0.00	
Ipk-Hold	-0.86 Apk	CF	5.58	
1φ All				
Freq	50.00 Hz	ACV	1:Ipk Limiter	
Wave	SIN		2:Irms Limiter	
			3:V/F Limiter	
Osc	Measure	Misc	Limiter	

2. Set the value of RMS current limiter in [Io] item.

Continuous		100V	AC-INT	1P2W
		3.0k		
1φ L1				
V	0.1 Vrms	P	0.0 W	
I	0.03 Arms	S	0.0 VA	
		Q	0.0 var	
		PF	0.00	
Ipk-Hold	-0.86 Apk	CF	5.71	
Irms Limiter				
Io	31.5 Arms			
Output OFF	Disable			
Close				

3. Set the [Output OFF] item as [Enable] or [Disable]. When setting to [Enable], also set the time from the start of limiter operation to the output off.

Continuous		100V	AC-INT	1P2W
		3.0k		
1φ L1				
V	0.1 Vrms	P	0.0 W	
I	0.03 Arms	S	0.0 VA	
		Q	0.0 var	
		PF	0.00	
Ipk-Hold	-0.86 Apk	CF	5.62	
Irms Limiter				
Io	1:Disable			
	2:Enable			
Output OFF	Disable			
Close				

4. Close the window.

4.1.3 Using Voltage Setting Range Limit

For the Continuous function, when the signal source is INT, SYNC, or ADD, the range of the output voltage setting value to the internal signal source can be limited. Even if trying to set a voltage that exceeds the limit, the setting value is restricted to the limiting value. This can prevent mis-setting when you do not want to set values outside the range.

As for the voltage setting range limiting values, each value is kept independently for the following settings for 100 V and 200 V ranges respectively: SIN/CLP waveform in AC mode, ARB waveform in AC mode, ACDC mode, and DC mode.

In case of polyphase output, the setting of the voltage setting range limit is common to all phases, and kept as the effective value of the phase voltage in this product. When the line voltage setting (effective value setting) is selected in balanced mode, it is converted into the effective value setting of the phase voltage according to the following formula and kept in this product.

Balanced three-phase output:

$$\text{Phase voltage} = \frac{1}{\sqrt{3}} \times \text{Line voltage}$$

Balanced single-phase three-wire output:

$$\text{Phase voltage} = \frac{1}{2} \times \text{Line voltage}$$

The limiting value should be set using the effective value or the positive and negative peak value. The effective value can be used only when in the AC mode and the waveform is a sine wave or a clipped sine wave. The limiting value can be set using the line voltage in polyphase output when in AC mode and balanced mode, and the output voltage setting is a line voltage setting. In other cases, set using the positive and negative peak values of phase voltage.

For the default setting range, see 10.14.

Notes

- The voltage setting range limit is useful for the prevention of an excessive output when a setting value is rapidly increased or decreased by using the shuttle.
 - The limitation is applied to the additional values of the AC voltage setting (recalculated to a peak value) and the DC voltage setting.
 - The voltage setting range limit cannot be applied to the external signal source of EXT and ADD.
 - The Sequence and the Simulation function do not include the voltage setting range limiting function.
 - The voltage setting range limit that does not include an output voltage already set cannot be set.
 - In polyphase output, the voltage setting range limit is common to all phases.
 - In ACDC mode, set the voltage setting range limit setting using the positive and negative peak values of the phase voltage regardless of the settings of the waveform, balanced/unbalanced mode, phase voltage/line voltage.
-

■ Operation procedure

1. Push [Limiter] soft-key to select 3: V/F Limiter (or push **SHIFT** + **V**). Opens the setting window for the voltage/frequency setting range limit.

Continuous		100V	ACDC-INT	1P2W
		3.0k		
1φ L1				
V	0.1 Vrms	P	0.0 W	
I	0.03 Arms	S	0.0 VA	
		Q	0.0 var	
		PF	0.00	
Ipk-Hold	-0.86 Apk	CF	5.15	
1φ All				
Freq	50.00 Hz	ACV	1: Ipk Limiter	
Wave	SIN	DCV	2: I rms Limiter	
			3: V/F Limiter	
Osc	Measure	Misc	Limiter	

2. The screen for the effective value setting or the peak value setting opens depending on the signal source setting/output waveform settings made here. Set the voltage setting range limiting value in the [V] item (effective value setting) and [+Vop]/[-Vop] item (peak value setting).

Effective Value Setting

Continuous		100V	AC-INT	1P2W
		3.0k		
1φ L1				
V	0.1 Vrms	P	0.0 W	
I	0.03 Arms	S	0.0 VA	
		Q	0.0 var	
		PF	0.00	
Ipk-Hold	-0.86 Apk	CF	5.34	
V/F Setting Range Limiter				
V	155.0 Vrms	Freq Up	550.00 Hz	
		Freq Lo	40.00 Hz	
Close				

Peak value setting

Continuous		100V	ACDC-INT	1P2W
		3.0k		
1φ L1				
V	0.1 Vrms	P	0.0 W	
I	0.03 Arms	S	0.0 VA	
		Q	0.0 var	
		PF	0.00	
Ipk-Hold	-0.86 Apk	CF	5.23	
V/F Setting Range Limiter				
+Vop	220.0 Vpk	Freq Up	550.00 Hz	
-Vop	-220.0 Vpk	Freq Lo	1.00 Hz	
Close				

3. Close the window.

4.1.4 Using Frequency Setting Range Limit

You can limit the range of the frequency setting value for the internal signal source by using the frequency setting range limit. Even if trying to set a frequency that exceeds the limit, the setting value is restricted to the limiting value. This can prevent mis-setting when you do not want to set values outside the range.

The frequency setting range limiting value is common to both 100 V and 200 V ranges.

For the default setting range, see 10.14.

Notes

- The frequency setting range limit is useful for the prevention of an unintended frequency setting when a setting value is rapidly increased or decreased by using the shuttle.

■ Operation procedure

1. Push [Limiter] soft-key to select 3: V/F Limiter (or push **SHIFT**+**F**). Opens the setting window for the voltage/frequency setting range limit.

Continuous		100V	ACDC-INT	1P2W
		3.0k		
1φ L1				
V	0.1 Vrms	P	0.0 W	
I	0.03 Arms	S	0.0 VA	
		Q	0.0 var	
		PF	0.00	
Ipk-Hold	-0.86 Apk	CF	5.15	
1φ All				
Freq	50.00 Hz	ACV	1: Ipk Limiter	
Wave	SIN	DCV	2: Irms Limiter	
			3: V/F Limiter	
Osc	Measure	Misc	Limiter	

2. Set values in the [Freq Up]/[Freq Lo] item so that the upper value of the frequency setting range limit is higher than or equal to the lower limit.

Continuous		100V	AC-INT	1P2W
		3.0k		
1φ L1				
V	0.1 Vrms	P	0.0 W	
I	0.03 Arms	S	0.0 VA	
		Q	0.0 var	
		PF	0.00	
Ipk-Hold	-0.86 Apk	CF	5.15	
V/F Setting Range Limiter				
V	155.0 Vrms	Freq Up	550.00 Hz	
		Freq Lo	40.00 Hz	
Close				

3. Close the window.

4.1.5 About Wattage Limiter

The wattage limiter operates when trying to output the power exceeding the rated power. When the wattage limiter operates, the output voltage is suppressed until the active power per phase is the value in Table 4-1 (reference value). While the limiter is working, icon **WAT** is displayed and LIMIT LED illuminates.

Table 4-1 Wattage Limiter Value per Phase

		Rated output per phase	Wattage limiter value (reference value)
Number of power units per phase	1	1.5 kVA	1.575 kW
	2	3 kVA	3.150 kW

----- Notes -----

- If the wattage limiter operates, suppress the output wattage within the rated output power by lowering the output voltage setting value.
 - Active power (unit: W) is restricted by the wattage limiter, however, reactive power (unit: var) is not restricted. Therefore, the apparent power (unit: VA) may exceed the rated power depending on the power factor of the load. Set the output voltage so that the apparent power does not exceed the rated power, regardless of the operation of the wattage limiter.
 - The value of the wattage limiter cannot be changed. To limit the output power to a value that is lower than the rating, decrease the number of power units that are energized through the power unit energization setting, or use the peak current limiter or the RMS current limiter.
-

4.2 Using Sequence Function

4.2.1 Basics

By using Sequence function, an output setting can be changed step-by-step according to the program (sequence) created beforehand. This section describes the basics for using the Sequence function.

■ AC/DC Mode and Signal Source

Sequence function keeps the selection of the AC/DC mode and a signal source, independently from Continuous function/Simulation function. AC/DC mode can be selected from AC/ACDC/DC. A signal source is fixed as INT.

■ Keep a sequence setting

The sequence setting is kept per AC/DC mode. Every time AC/DC mode is changed, the sequence setting that is already kept is loaded. The sequence setting is cleared when the power is turned off. To save the setting, you need to save it in internal memory or USB memory (see 4.9).

■ Step

One sequence consists of a series of two or more steps. To use Sequence function, first set each step.

■ Step-control Parameters and intra-Step Parameters

There are the following two major types of parameters in Sequence function:

● Step-control parameter

Parameter to control the flow between two or more steps. This defines duration of each step and the next step to transition. Settings of step synchronous code and trigger output are included in step-control parameter for convenience.

● Intra-Step parameter

Parameter to define output state in each step. This defines basic parameters such as a waveform, frequency, and how they are changed in the step.

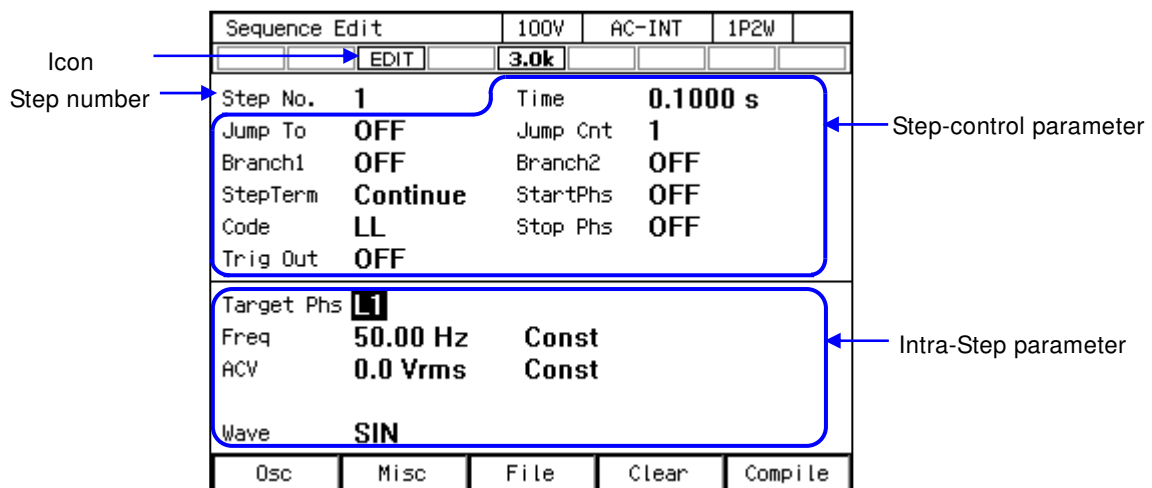

Figure 4-1 Step-control Parameters and intra-Step Parameters

■ Step No. 0

Step No. 0 is assigned to the stand-by state before the sequence starts. If the terminal specification of the step other than No. 0 is End, the execution transitions to step No. 0 and enters into the stand-by state. Step Time and the Step Behavior setting of No. 0 specifies the action to transit to No. 0 at the end of a sequence.

■ Step Behavior (Const, Keep, Sweep)

For the intra-Step parameter other than waveforms and phases, the following three patterns can be set as the method to change values in the step.

- Constant (Const)

Fixed to the value set in the step.

- Keep

Keeping the value immediately before transitioning to the step. That is, the value is changed depending on the status of the previous step. Although the parameter value can be set even if the operation type setting is Keep, the parameter setting value is ignored when sequence is executed.

- Sweep

It changes linearly from the value immediately before transitioning to the value set in the step, taking the Step Times. In other words, it reaches the setting value after the Step Time passes in the step. The starting value is changed depending on the status of the previous step.

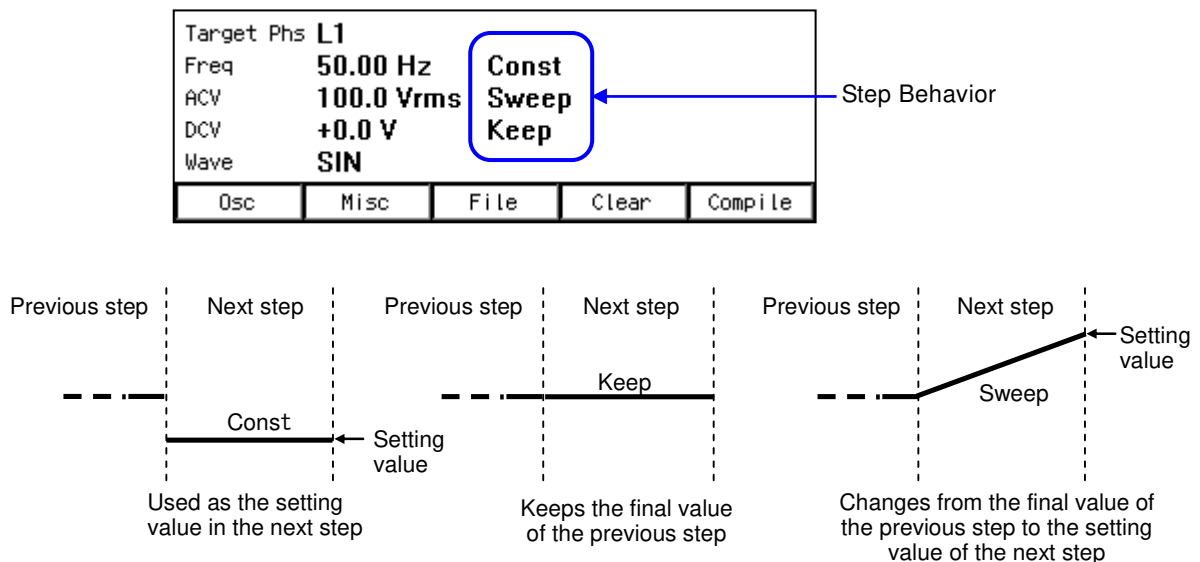

Figure 4-2 Step Behavior

Notes

- The Step Behavior for the waveform and phase is always Constant (Const).
- Keeps as many intra-Step parameter setting values as the number of phases in each step based on the output phase configuration.
- Cannot be set using line voltage in the single-phase three-wire output and three-phase output.
- The rate of crest factor/clip ratio cannot be changed though a clipped sine wave can be selected as an output waveform in Sequence function. Set these parameters beforehand using Continuous function.
- Sequence function displays the measured value in Sequence function, which is equivalent to that of the Continuous function. However, harmonic current measurement (see 4.4) cannot be displayed.

4.2.2 Parameters of Sequence Function

Table 4-2 shows the parameters of Sequence function. The common parameters are common to one sequence. In Sequence function, signal source is fixed to INT. In each step, set the step-control parameter and the intra-Step parameter. As for intra-Step parameter, the item and range that can be set differ depending on the output range (100 V/200 V range) and output mode (AC-INT/ACDC-INT/DC-INT) as in the case of Continuous function. This section describes intra-Step parameters and step-control parameters separately.

Table 4-2 Parameters of Sequence Function

Common parameter	Step-control parameter	Intra-Step parameter
Output range AC/DC mode	Step Time Jump-to step Jump count (1 to 9999, or infinite) Branch step Step termination Step sync code output (2bit) Start Phase Stop Phase Trigger output	Frequency Waveform Phase angle AC phase voltage DC voltage

- Frequency (Freq), waveform (Wave), phase angle (Phase), AC phase voltage (ACV), DC voltage (DCV)

The setting for the output of each step. In polyphase system, AC phase voltage and phase angle can be set for each phase. In the phase angle, set the phase difference with the L1 phase. Phase angle can also be set per step. The phase angle of L1 phase cannot be set, and is fixed as 0 deg.

- Step Time (Step Time)

Set the output time of that step. Unit can be selected from [s] or [ms].

- Jump-to step (Jump To)

When selected, the destination step of the jump at the end of the step can be specified. By specifying the Jump count ([Jump Cnt]), you can set up a loop to repeat the same step. After jumping for the times specified for one sequence, the action at the end of step follows the step termination setting.

If Jump-to is set to off, the action at the end of step follows the step termination setting.

----- Notes -----

- When the step termination is set as [Hold], the hold status is enabled before the jump.
-

■ Jump count (Jump Cnt)

Number of times of jumps to jump to the step specified in Jump-to. This can be set when Jump-to ([Jump To]) is selected. When the Jump count is set to 0, infinite times of jumps occur.

----- Notes -----

- The number of times that a particular step is repeated is Jump count + 1.
-

■ Branch step (Branch1, Branch2)

When the step is under execution or in the hold state, the step to transition when the branching instruction through panel operation or external control is detected can be specified. There are two systems of branch instructions (Branch1 and Branch2), and an instruction can be set for each.

----- Notes -----

- Transition using branch is executed immediately after a branching instruction is detected. Step Time, Stop Phase, and step termination setting are ignored.
-

■ Step termination (Step Term)

Specifies the action when the step completes. When [Continue] is selected, transitions to the step of the next number. When [End] is selected, the sequence is terminated and the execution transitions to step No. 0 and enter into the stand-by state. When [Hold] is selected, the output at the end of the step is suspended, and the execution transitions to the step of the next number when Resume instruction is detected.

----- Notes -----

- When [Step Term] is set to [Hold], the execution enters into hold state before jump. Jumps when Resume instruction is detected.
 - When [Step Term] is set to [Hold], after the jumps repeated for the specified Jump count, the execution transitions to the step of the next number when Resume instruction is detected in hold state.
 - While in the hold state due to the step termination in a step where step termination phase is enabled, the execution transitions to Jump-to step or the step of next number when Resume instruction is detected, after the hold state is kept until Stop Phase.
-

■ Step sync code output (Code)

State output to CONTROL I/O connector. Code to output while the execution of the step, which is specified by 2-bit H/L.

■ Start Phase (StartPhs)

Determines the phase of AC waveform of L1 phase when the step starts. The phase when a step starts in L2 and L3 phase of polyphase system is the addition of the setting value of intra-Step parameter Phase and the setting value of the step Start Phase.

----- Notes -----

- Step Start Phase setting can be disabled. In that case, the phase when the phase starts becomes the phase when the previous step ended.
 - In DC mode, the step Start Phase cannot be set.
-

■ Stop Phase (Stop Phs)

Determine the phase of AC waveform when the step ends. The phase when a step ends in L2 and L3 phase of polyphase system is the addition of the setting value of intra-Step parameter Phase and the setting value of the step Stop Phase. When the stop phase setting is active, the execution waits for the Step Time that was set pass, and keeps the output setting until it reaches the Stop Phase that was set, and then transitions to the next step. As the result, the actual step time is longer by one cycle at a maximum than the set Step Time. Figure 4–3 shows an example where both the Stop Phase of the previous step and the Start Phase of the next step are set to 0°.

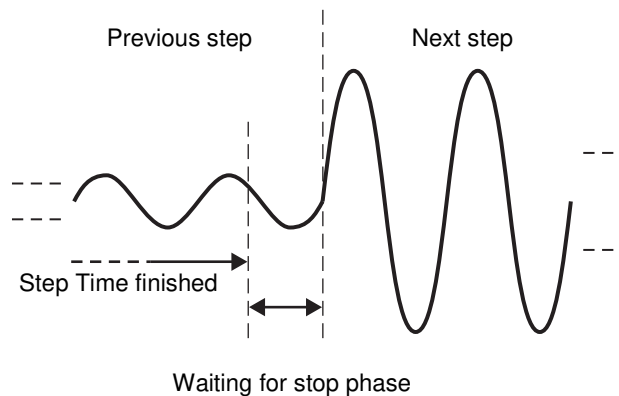

Figure 4-3 Stop Phase

----- Notes -----

- When the Step Behavior is set to [Sweep], output is constant while waiting for the step Stop Phase after the Step Time passes.
 - Step Stop Phase setting can be disabled. In this case, when the set Step Time has passed, the execution transitions to the next step without waiting for step Stop Phase.
 - In DC mode, the step Stop Phase cannot be set.
-

■ Trigger output (Trig Out)

State output to CONTROL I/O connector. This specifies whether the trigger output presents when the step starts. Polarity and pulse width of the trigger output complies with the trigger output setting (see 4.2.5).

4.2.3 Example of Output Using Sequence Function

As an example, consider the sequence that gradually changes DC voltage like Figure 4-4.

Set the output mode to DC-INT. Edit the sequence like Table 4-3. Parameters not included in this table should be left as the factory default setting.

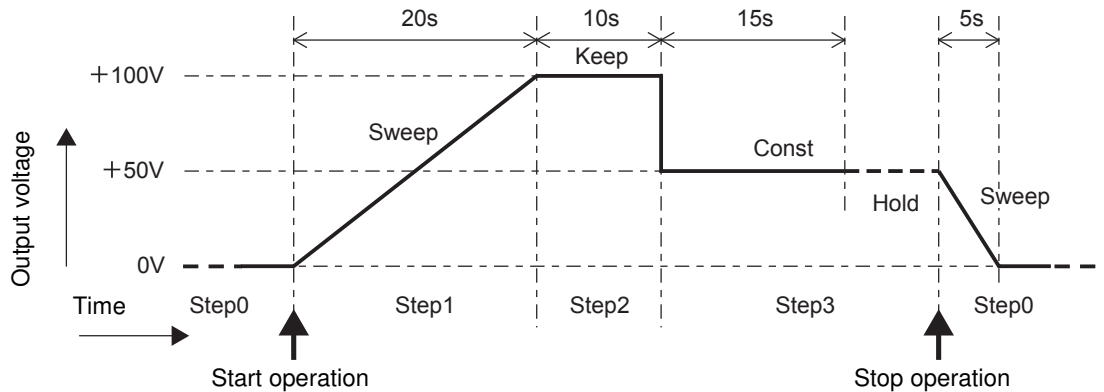

Figure 4-4 Example of Sequence

Table 4-3 Example of Editing Sequence

Step Number		0	1	2	3
Step-control parameter	Step Time (Time)	5 s	20 s	10 s	15 s
	Jump-to (Jump To)	—	OFF	OFF	OFF
	Step termination (Step Term)	—	Continue	Continue	Hold
Intra-Step Parameter	DC Voltage (DCV)	0 V	+100 V	(Optional)	+50 V
	Step Behavior	Sweep	Sweep	Keep	Const

Notes

- Step Time and the Step Behavior of step No. 0 specifies the action after the transition to step No. 0 at the end of a sequence.
- Jump-to of step No. 0 cannot be specified. The execution always transitions to step No. 1 when the sequence starts.
- In the case that the step termination is set to [Hold] (No. 3), and when the execution is in the Hold state, it transitions to step No. 0 and enters into the stand-by state if the Stop operation is executed. If you perform Resume operation here, the execution transitions to the step of the next number (No. 4).

4.2.4 Process Flow in a Step

Figure 4-5 shows the process flow in one step. The transition such as Figure 4-6 occurs by branch operation or stop operation, regardless of the flow in the step.

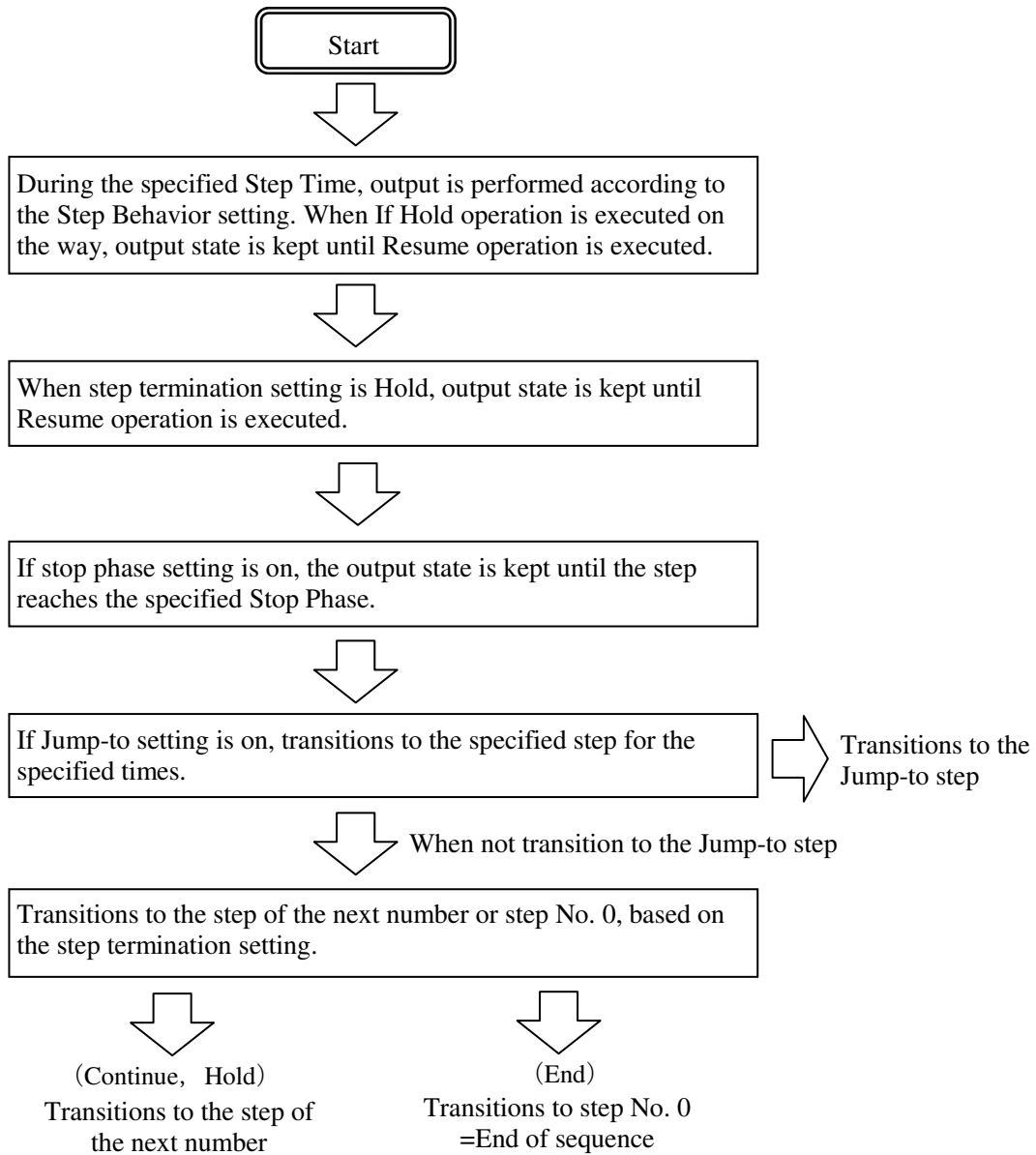

Figure 4-5 Process Flow in Sequence Step

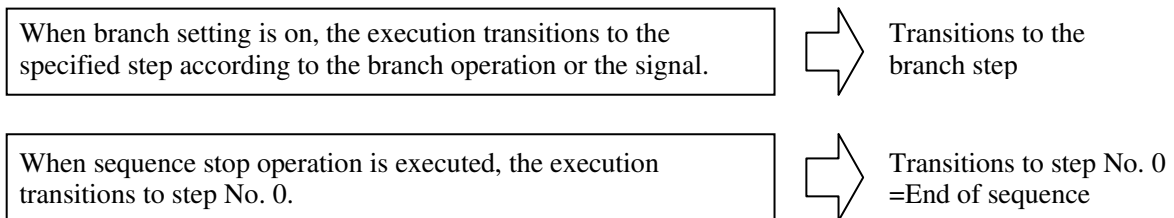

Figure 4-6 Branch Operation/Stop Operation

4.2.5 Edit a Sequence

----- Notes -----

- A sequence being edited is kept per AC/DC mode. If AC/DC mode is changed, the edited contents of sequence are loaded based on the change.
 - When the power is turned off, edited contents of the sequence are cleared, and all sequences have the default setting values when it is started next time. To keep the edited contents of sequence, save them in the Sequence Memory (see 4.2.8).
 - When the sequence is loaded from Sequence Memory, the sequence being edited at that time is discarded.
 - You can also turn the output on in the Sequence Edit View. In this case, the output will be set to the state set in the Step No.0 when the sequence was last compiled (see 4.2.7).
-

■ Transit to Sequence Edit View

Press the MENU key to open the root menu, then select [Sequence] (see 3.3.1). While the Sequence Control View is displayed, if you push the [Edit] soft-key, the execution transitions to the Sequence Edit View.

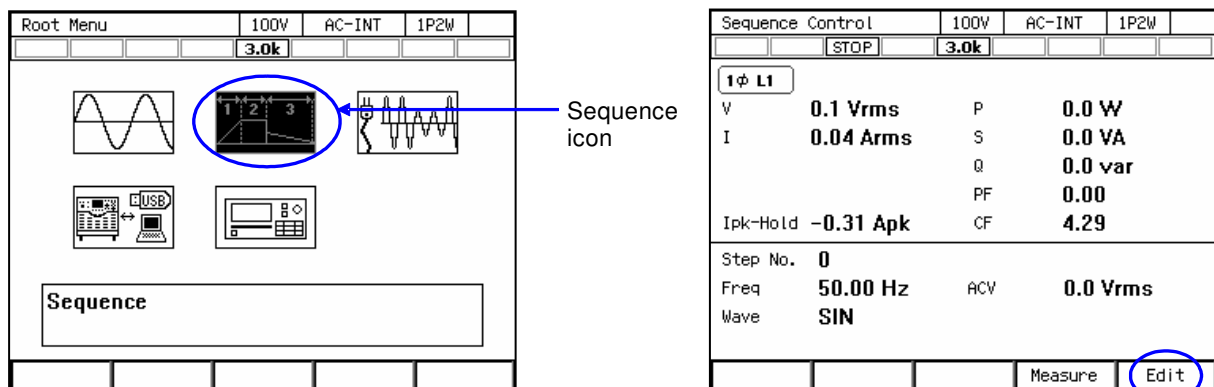

■ Edit a sequence

1. Push [Osc] soft-key on Sequence Edit View, then select AC/DC mode and 100 V/200 V range. To edit the saved sequence, load the sequence (see 4.2.6).

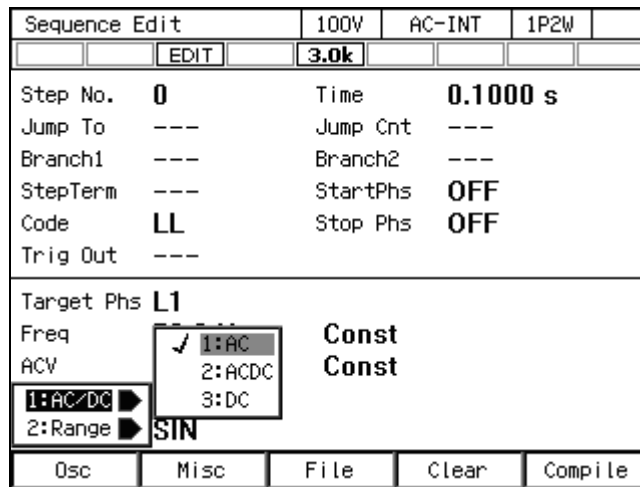

2. Set the parameter of each step. You can move between each step by changing [Step No.].

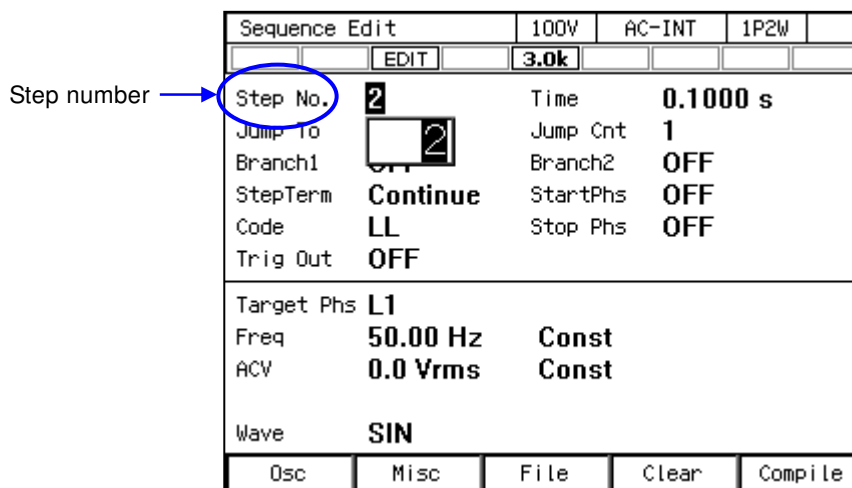

3. You can select s or ms as the unit of Step Time by selecting [Misc] soft-key → [1: TimeUnit].

Sequence Edit		100V	AC-INT	1P2W
EDIT		3.0k		
Step No.	2	Time	0.1000 s	
Jump To	OFF	Jump Cnt	1	
Branch1	OFF	Branch2	OFF	
StepTerm	Continue	StartPhs	OFF	
Code	LL	Stop Phs	OFF	
Trig Out	OFF			
Target Phs L1				
Freq	50.00 Hz	Const		
ACV	0.0 Vrms	Const		
Wave	1:TimeUnit	2:ms	✓ 1:s	
Osc	Misc	File	Clear	Compile

4. You can set polarity of trigger output and pulse width by selecting [Misc] soft-key → [2: Trig Out].

Sequence Edit		100V	AC-INT	1P2W
EDIT		3.0k		
Step No.	2	Time	0.1000 s	
Jump To	OFF	Jump Cnt	1	
Branch1	OFF	Branch2	OFF	
StepTerm	Continue	StartPhs	OFF	
Code	LL	Stop Phs	OFF	
Trig Out	OFF			
Trig Out				
Polarity	Negative			
Width	10.0 ms			
Close				

4.2.6 Load a Sequence

----- Notes -----

- When the sequence is loaded, the sequence being edited at that time is discarded.
- In Sequence Control View, a sequence cannot be loaded.

■ Load the sequence stored in the internal memory

1. In Sequence Edit View, select [File] soft-key → [2: Recall]. Sequence Recall View is opened.

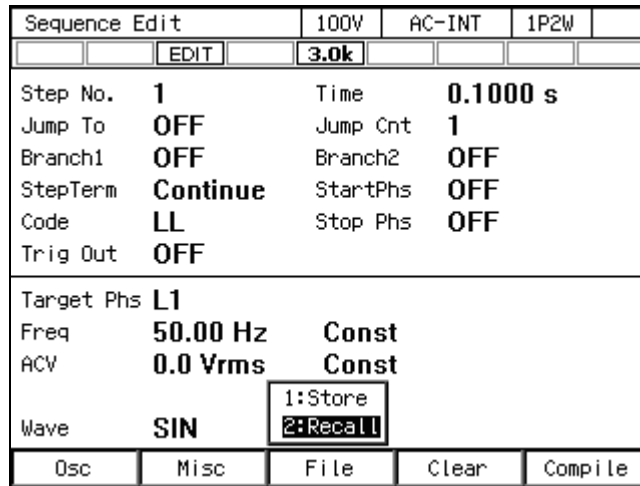

2. In the [From] item, select [1: System].

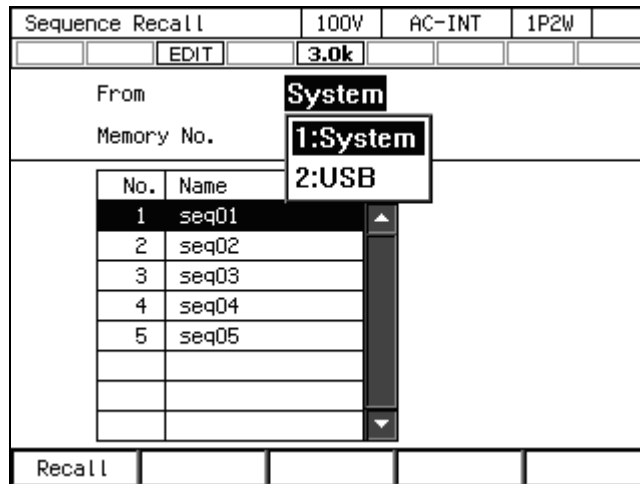

- Specify the memory number of the sequence to be loaded in [Memory No.] item, and then push [Recall] soft-key.

Sequence Recall		100V	AC-INT	1P2W
EDIT		3.0k		
From		System		
Memory No.		1		
No.	Name			
1	seq01			
2	seq02			
3	seq03			
4	seq04			
5	seq05			
Recall				

- The confirmation window for loading the sequence opens. Select [OK]. The sequence with the specified memory number is loaded.

Sequence Recall		100V	AC-INT	1P2W
EDIT		3.0k		
From		System		
Memory No.		1		
No.	Name			
1	seq01			
2	seq02			
3	seq03			
4	seq04			
Recall				
Recall Data? No.1 Name : seq01				
Cancel		OK		

■ Load the sequence stored in the USB memory

For how to connect USB memory to this product, and how to disconnect from this product, see 4.9.

1. In Sequence Edit View, select [File] soft-key → [2: Recall]. Sequence Recall View is opened.

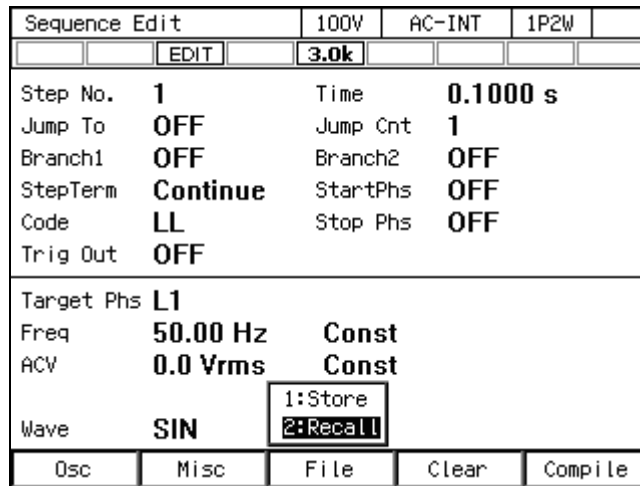

2. In the [From] item, select [2: USB].

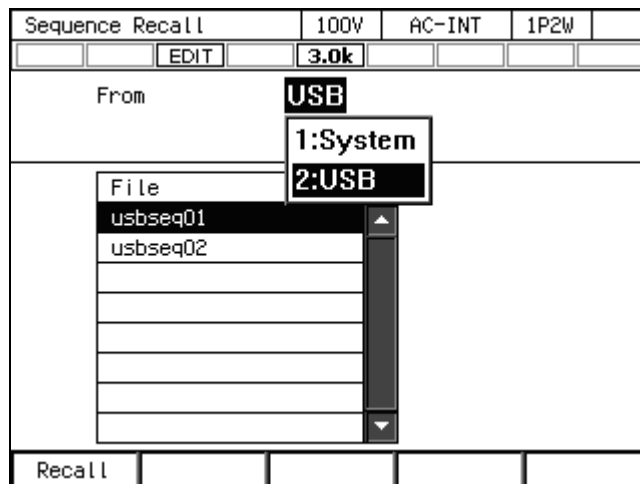

3. From data list box, select the sequence to load.

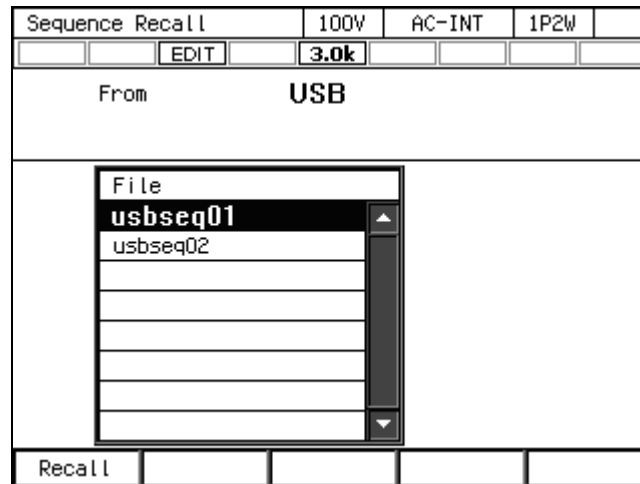

4. Push the [Recall] soft-key.
5. The confirmation window for loading the sequence opens. Select [OK]. The specified sequence data is loaded.

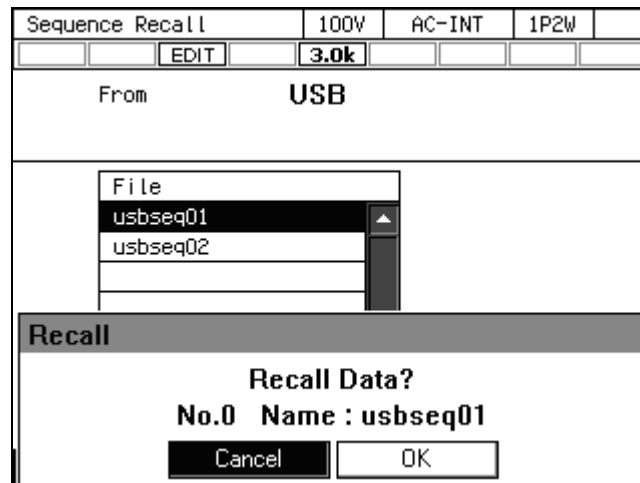

----- Notes -----

- The number of sequence data files saved in a USB memory should be 500 or less. If the number of files exceeds this limit, this product cannot recognize the sequence data files in the USB memory.
-

4.2.7 Execute a Sequence

The edited sequence can be executed after converted to executable program by compile operation.

■ Transition to Sequence Control View

When pushing [Compile] soft-key in the Sequence Edit View, the edited sequence is compiled, and then the screen transitions to Sequence Control View. If output is turned on in the Sequence Edit View, the output transitions to the state set in the step No.0 at the same time as compiling.

Sequence Edit		100V	AC-INT	1P2W
EDIT		3.0k		
Step No.	1	Time	0.1000 s	
Jump To	OFF	Jump Cnt	1	
Branch1	OFF	Branch2	OFF	
StepTerm	Continue	StartPhs	OFF	
Code	LL	Stop Phs	OFF	
Trig Out	OFF			
Target Phs L1				
Freq	50.00 Hz	Const	Const	
ACV	0.0 Vrms	Const	Const	
Wave SIN				
Osc	Misc	File	Clear	Compile

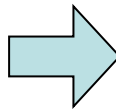

Sequence Control		100V	AC-INT	1P2W
STOP		3.0k		
1φ L1				
V	0.1 Vrms	P	0.0 W	
I	0.16 Arms	S	0.0 VA	
		Q	0.0 var	
		PF	0.03	
		CF	4.00	
Ipk-Hold +4.07 Apk				
Step No. 0				
Freq	50.00 Hz	ACV	0.0 Vrms	
Wave SIN				
Start			Measure	Edit

Sequence Edit View

Sequence Control View

- Notes -----
- If an improper setting is detected during compilation, an error message is displayed and the screen does not transition to the Sequence Control View.
-

■ Start/Terminate a sequence

1. If output is turned off in the Sequence Edit View, the sequence can be executed when output is turned on in the Sequence Control View. At this point, the output is in the state set in the step No. 0. When a sequence is stopped, the **STOP** icon is displayed.

Sequence Control		100V	AC-INT	1P2W
STOP		3.0k		
1φ L1				
V	0.1 Vrms	P	0.0 W	
I	0.04 Arms	S	0.0 VA	
		Q	0.0 var	
		PF	0.00	
Ipk-Hold	-0.31 Apk	CF	4.29	
Step No. 1				
Freq	50.00 Hz	ACV	0.0 Vrms	
Wave	SIN			
Start			Measure	Edit

2. When pushing [Start] soft-key, the sequence is started. While the sequence is executed, icon **RUN** is displayed.

Sequence Control		100V	AC-INT	1P2W
RUN		3.0k		
1φ L1				
V	0.1 Vrms	P	0.0 W	
I	0.04 Arms	S	0.0 VA	
		Q	0.0 var	
		PF	0.00	
Ipk-Hold	-0.31 Apk	CF	4.23	
Step No. 4				
Freq	50.00 Hz	ACV	0.0 Vrms	
Wave	SIN			
	Stop	Hold	Bran1	Bran2

4. Advanced Operation

- When [Stop] soft-key is pushed while sequence is executed, the execution transitions to the output state that is set in the step No. 0, and then sequence is terminated. The output remains on.

Sequence Control		100W	AC-INT	1P2W
STOP		3.0k		
1ϕ L1				
V	0.1 Vrms	P	0.0 W	
I	0.04 Arms	S	0.0 VA	
		Q	0.0 var	
		PF	0.00	
Ipk-Hold	-0.31 Apk	CF	4.29	
Step No. 1				
Freq	50.00 Hz	ACV	0.0 Vrms	
Wave	SIN			
Start			Measure	Edit

----- Notes -----

- In the output off state, the sequence cannot be started.
 - Output on/off setting is not active in sequence.
-

■ Return to Sequence Edit View

If you push the [Edit] soft-key, the execution transitions back to the Sequence Edit View.

■ Suspend a sequence

1. When pushing [Hold] soft-key while a sequence is executed, the sequence is suspended. The output state is kept while suspended. Icon **[HOLD]** is displayed.

Sequence Control		100V	AC-INT	1P2W
RUN		3.0k		
1φ L1				
V	0.1 Vrms	P	0.0 W	
I	0.04 Arms	S	0.0 VA	
		Q	0.0 var	
		PF	0.00	
Ipk-Hold	-0.31 Apk	CF	4.23	
Step No. 4				
Freq	50.00 Hz	ACV	0.0 Vrms	
Wave	SIN			
Stop		Hold	Bran1	Bran2

2. To restart the sequence, push [Resume] soft-key. If you push [Stop] soft-key, the execution transitions to step No. 0 and the sequence is terminated.

Sequence Control		100V	AC-INT	1P2W
HOLD		3.0k		
1φ L1				
V	0.1 Vrms	P	0.0 W	
I	0.04 Arms	S	0.0 VA	
		Q	0.0 var	
		PF	0.00	
Ipk-Hold	-0.31 Apk	CF	4.23	
Step No. 7				
Freq	50.00 Hz	ACV	0.0 Vrms	
Wave	SIN			
Resume	Stop		Bran1	Bran2

■ Branch a sequence

If you push [Bran1] or [Bran2] soft-key while a sequence is executing, the execution transitions to the branch step 1 or 2 that is set in the step being executed.

Sequence Control		100W	AC-INT	1P2W
HOLD		3.0k		
1φ L1				
V	0.1 Vrms	P	0.0 W	
I	0.04 Arms	S	0.0 VA	
		Q	0.0 var	
		PF	0.00	
Ipk-Hold	-0.31 Apk	CF	4.23	
Step No. 7				
Freq	50.00 Hz	ACV	0.0 Vrms	
Wave	SIN			
Resume	Stop		Bran1	Bran2

4.2.8 Save a Sequence

----- Notes -----

- In Sequence Control View, a sequence cannot be saved.
- All sequence data that are edited in each mode of AC/DC mode are saved as one memory number/file by one save operation.

■ Save a sequence to internal memory

1. In Sequence Edit View, select [File] soft-key → [1: Store]. Sequence Store View is opened.

Sequence Edit		100W	AC-INT	1P2W
EDIT		3.0k		
Step No.	1	Time	0.1000 s	
Jump To	OFF	Jump Cnt	1	
Branch1	OFF	Branch2	OFF	
StepTerm	Continue	StartPhs	OFF	
Code	LL	Stop Phs	OFF	
Trig Out	OFF			
Target Phs	L1			
Freq	50.00 Hz	Const		
ACV	0.0 Vrms	Const		
Wave	SIN	1:Store	2:Recall	
Osc	Misc	File	Clear	Compile

2. In the [To] item, select [1: System].

Sequence Store	100V	AC-INT	1P2W
	EDIT	3.0k	
To	System		
Memory No.	1:System		
	2:USB		
No.	Name		
1	seq01		
2	seq02		
3	seq03		
4	seq04		
5	seq05		
Store		Clear	Rename

3. Specify the memory number of location to save in [Memory No.] item, and then push [Store] soft-key.

Sequence Store	100V	AC-INT	1P2W
	EDIT	3.0k	
To	System		
Memory No.	1		
	1		
No.	Name		
1	seq01		
2	seq02		
3	seq03		
4	seq04		
5	seq05		
Store		Clear	Rename

4. A window to confirm the save name opens. Enter the name, and then select [OK]. For how to enter a string, see 3.3.6.

Sequence Store	100V	AC-INT	1P2W
	EDIT	3.0k	
To	System		
Memory No.	1		
No.	Name		
1	seq01		
2	seq02		
3	seq03		
4	seq04		
Store Name			
Name seq01			
Cancel		OK	

■ Save a sequence to USB memory

For how to connect USB memory to this product, and how to disconnect from this product, see 4.9.

1. In Sequence Edit View, select [File] soft-key → [1: Store]. Sequence Store View is opened.

Sequence Edit		100V	AC-INT	1P2W
EDIT		3.0k		
Step No.	1	Time	0.1000 s	
Jump To	OFF	Jump Cnt	1	
Branch1	OFF	Branch2	OFF	
StepTerm	Continue	StartPhs	OFF	
Code	LL	Stop Phs	OFF	
Trig Out	OFF			
Target Phs	L1			
Freq	50.00 Hz	Const		
ACV	0.0 Vrms	Const		
Wave	SIN	1:Store	2:Recall	
Osc	Misc	File	Clear	Compile

2. In the [To] item, select [2: USB].

Sequence Store		100V	AC-INT	1P2W
EDIT		3.0k		
To	System			
Memory No.	1:System			
	2:USB			
No.	Name			
1	seq01			
2	seq02			
3	seq03			
4	seq04			
5	seq05			
Store		Clear	Rename	

4.2.9 Clear/Rename Sequence

■ Clear/Rename a sequence saved in internal memory

1. In Sequence Edit View, select [File] soft-key → [1: Store]. Sequence Store View is opened.

Sequence Edit		100V	AC-INT	1P2W
EDIT		3.0k		
Step No.	1	Time	0.1000 s	
Jump To	OFF	Jump Cnt	1	
Branch1	OFF	Branch2	OFF	
StepTerm	Continue	StartPhs	OFF	
Code	LL	Stop Phs	OFF	
Trig Out	OFF			
Target Phs	L1			
Freq	50.00 Hz	Const		
ACV	0.0 Vrms	Const		
Wave	SIN	1:Store	2:Recall	
Osc	Misc	File	Clear	Compile

2. In the [To] item, select [1: System].

Sequence Store		100V	AC-INT	1P2W
EDIT		3.0k		
To	System			
Memory No.	1:System			
	2:USB			
No.	Name			
1	seq01			
2	seq02			
3	seq03			
4	seq04			
5	seq05			
Store		Clear	Rename	

3. Specify the number of memory to be operated in [Memory No.] item.

Sequence Store	100V	AC-INT	1P2W
	EDIT	3.ok	
To	System		
Memory No.	1		
No.	Name		
1	seq01		
2	seq02		
3	seq03		
4	seq04		
5	seq05		
Store		Clear	Rename

4. To clear, push [Clear] soft-key. Confirmation message is displayed. Select [OK]. In the cleared number of the memory, the sequence data at factory shipment is stored.

Sequence Store	100V	AC-INT	1P2W
	EDIT	3.ok	
To	System		
Memory No.	1		
No.	Name		
1	seq01		
2	seq02		
3	seq03		
4	seq04		
Clear			
Clear Data?			
No.1 Name : seq01			
Cancel		OK	

- To rename, push [Rename] soft-key. Rename window opens. Enter a new name and then select [OK]. For how to enter a string, see 3.3.6.

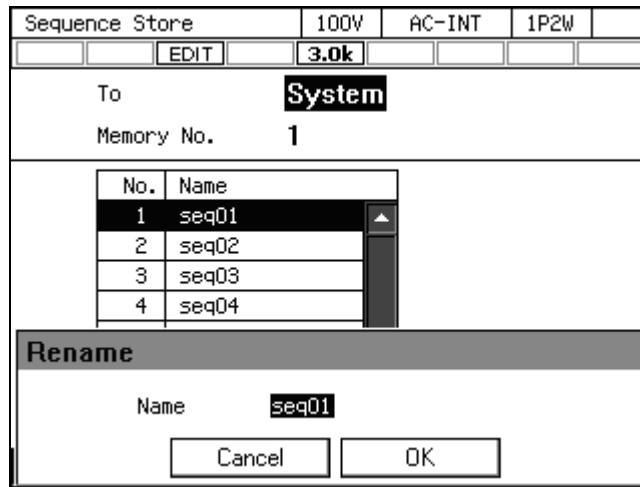

■ Delete/Rename a sequence saved in USB memory

For how to connect USB memory to this product, and how to disconnect from this product, see 4.9.

- In Sequence Edit View, select [File] soft-key → [1: Store]. Sequence Store View is opened.

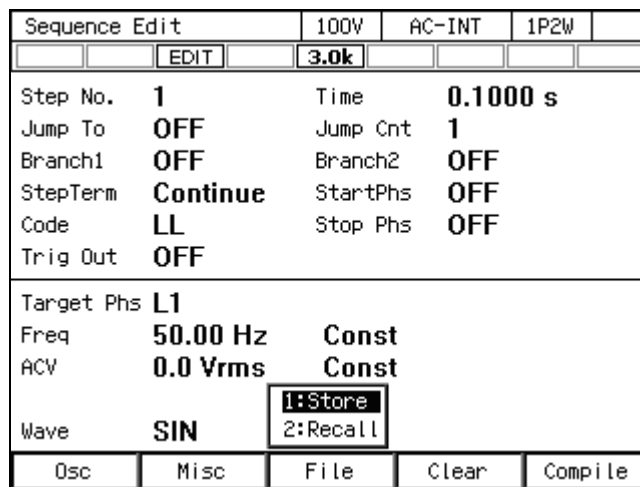

2. In the [To] item, select [2: USB].

Sequence Store	100V	AC-INT	1P2W
	EDIT	3.0k	
To	System		
Memory No.	1:System		
	2:USB		
No.	Name		
1	seq01		
2	seq02		
3	seq03		
4	seq04		
5	seq05		
Store			
Clear		Rename	

3. Select the data that is the target of the operation in the data list box.

Sequence Store	100V	AC-INT	1P2W
	EDIT	3.0k	
To	USB		
File			
usbseq01			
usbseq02			
Store			
New		Delete	
Rename			

4. To clear, push [Delete] soft-key. Confirmation message is displayed. Select [OK]. The corresponding file in USB memory is deleted.

Sequence Store	100V	AC-INT	1P2W
	EDIT	3.0k	
To	USB		
File			
usbseq01			
usbseq02			
Delete			
Delete File?			
File : usbseq01			
Cancel		OK	

- To rename, push [Rename] soft-key. Rename window opens. Enter a new name and then select [OK]. For how to enter a string, see 3.3.6.

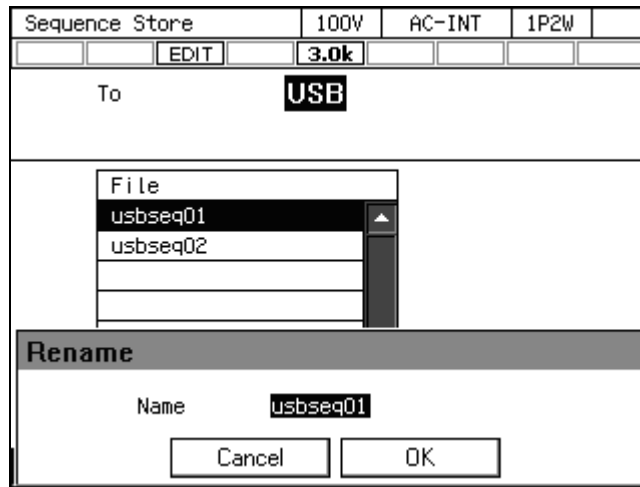

4.2.10 Set so as the Sequence Function is Selected at Power-on

You can set so as the Sequence function is selected at power-on.

■ Operation procedure

- Press the MENU key to move to the root menu, then select [System]. The system setting window opens.

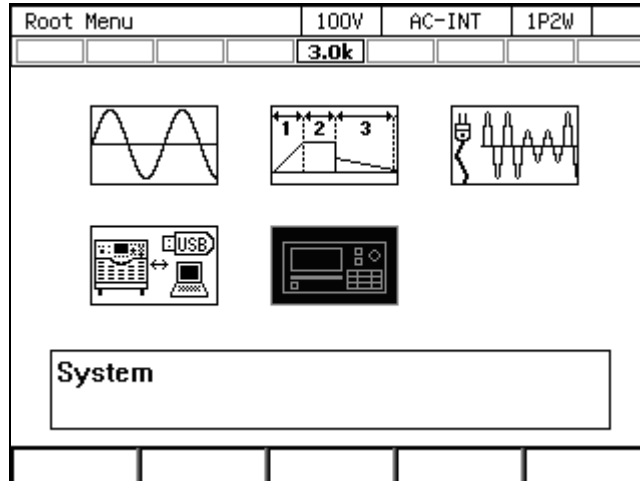

2. In [PwOn Mode] item, select [2: Seq].

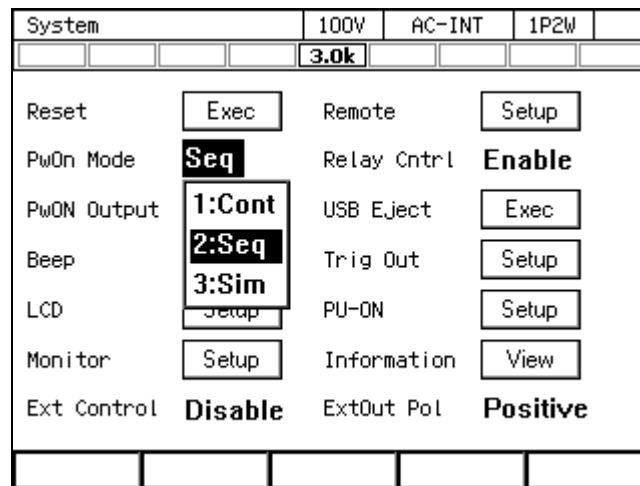

----- Notes -----

- To set so as to Continuous function is selected at power-on, select [1: Cont] in [PwOn Mode] item.
-

4.2.11 Sequence Control by External Control

External control enables to start/stop/suspend/branch a sequence and to recall the memory. For details, see 4.18.

4.2.12 Screen Overview

The Sequence function view is broadly separated into the Sequence Edit View and the Sequence Control View. It is Sequence Edit View that is displayed when sequence icon is selected from the root menu. After pushing [Compile] soft-key in Sequence Edit View, the screen transitions to the Sequence Control View.

----- Notes -----

- You cannot transition to root menu by pushing the MENU key in the Sequence Control View. To transition to the root menu, first move to the Sequence Edit View and then push the MENU key.
-

■ Sequence Edit View

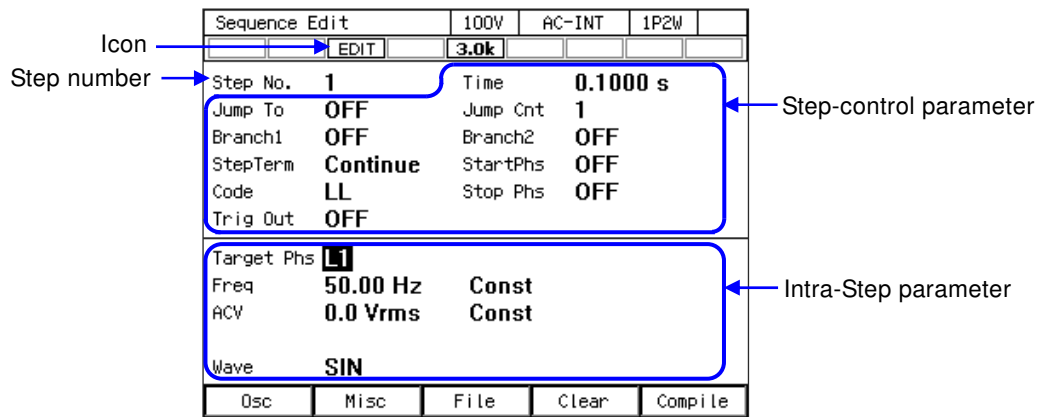

Figure 4-7 Sequence Edit View

■ Sequence Control View (output off state/sequence stopped)

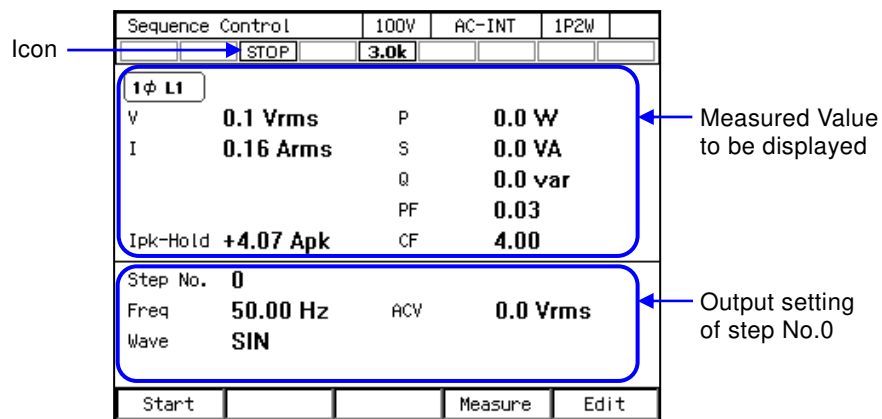

Figure 4-8 Sequence Control View (Output Off State)

■ Sequence Control View (output on state/sequence in execution)

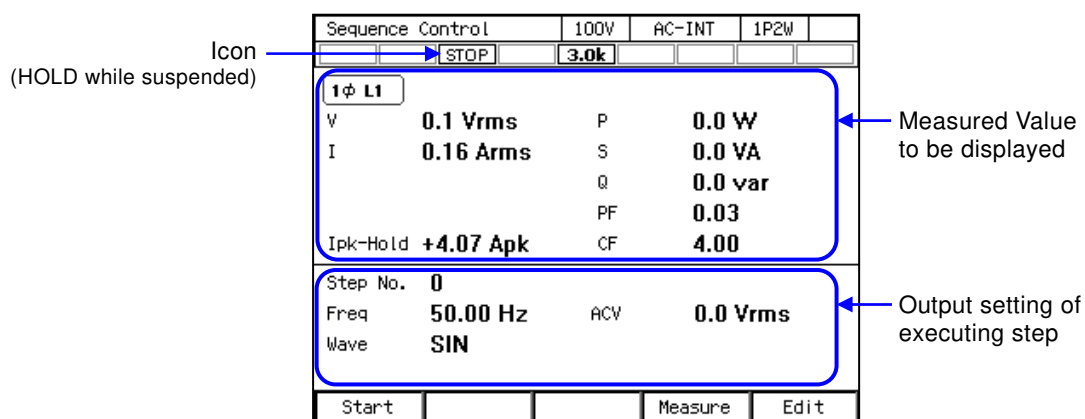

Figure 4-9 Sequence Control View (Output On State/Sequence in Execution)

■ Sequence Control View (output on state/sequence stopped)

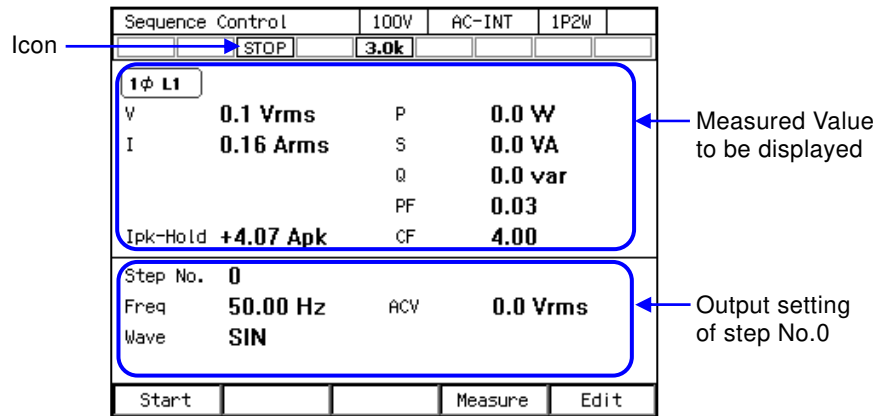

Figure 4-10 Sequence Control View (Output On State/Sequence Stopped)

4.3 Using Power Fluctuation Testing (Simulation) Function

4.3.1 Basics

The Power fluctuation testing (Simulation) function allows you to edit and output voltage patterns that simulate power line anomalies such as blackout, voltage rise, voltage drop, abrupt phase change, and abrupt frequency change. This section describes the basics for using the Simulation function.

■ AC/DC Mode and Signal Source

Simulation function sets the AC/DC mode and a signal source, independently from Continuous function/Sequence function. The setting is fixed to ACDC-INT.

■ Keep simulation setting file

The simulation setting is cleared when the power is turned off. To save the setting, you need to save it in internal memory or USB memory (see 4.9).

■ Step

The output by the Simulation function consists of six types of steps: Initial, Normal 1, Trans 1, Abnormal, Trans 2, and Normal 2. Before the simulation starts, KP3000S stands by at the Initial Step. During the simulation, the step changes in the order of Initial, Normal 1, Trans 1, Abnormal, Trans 2, and Normal 2. After the simulation ends, KP3000S returns to the Initial Step and stands by.

■ Step parameter

Each parameter of Step Time, AC voltage, frequency, start phase, stop phase, trigger output, and synchronization output can be set for each step. However, some parameters cannot be set in some steps.

■ Initial Step

Initial Step is assigned to the stand-by state before the simulation starts. KP3000S also moves to the Initial Step and becomes stand-by state after the simulation ends, except when the repeat count is specified to 0 (= infinite count).

■ Transition Step (Trans 1 and Trans 2)

The Step Times of Trans 1 and Trans 2 can be set to zero for simulating the abrupt voltage and phase changes. When the Step Time is set to the value other than zero, the set voltage and frequency are swept linearly at the previous and next steps. Note that the AC voltage, frequency, start phase, and Stop Phase cannot be set in the Transition Steps.

■ Other issues

- The Exit operation is available during the simulation. Performing the Exit operation moves to the Initial Step. The output remains on.
- You can set the repeat on/off and repeat count for the simulation. When the repeat is set to on and the repeat count to zero (0), the testing repeats infinitely.

----- Notes -----

- The Simulation function does not support the standard tests defined by organizations such as IEC. Use this function for a preliminary testing.
-

4.3.2 Simulation Function Parameters

Table 4-4 shows the parameters of Simulation function. The common parameters are common to one simulation. In the Simulation function, the signal source is fixed to INT sine wave and the ACDC mode to ACDC mode. When in polyphase, the balanced mode is always used. In each step, set the step-control parameter and the intra-Step parameter. As for intra-Step parameter, the range that can be set differ depending on the output range (100 V/200 V range) as in the case of Continuous function.

Table 4-4 Simulation Function Parameters

Common parameter	Step-control parameter	Intra-Step parameter
Output range AC/DC mode (Fixed to ACDC) Waveform (Fixed to sine wave)	Step Time Start Phase Stop Phase Trigger output Step sync code output (2bit) Repeat count (1 to 9999 or infinite)	Frequency AC voltage

■ Relationship between each step and settable Step parameters

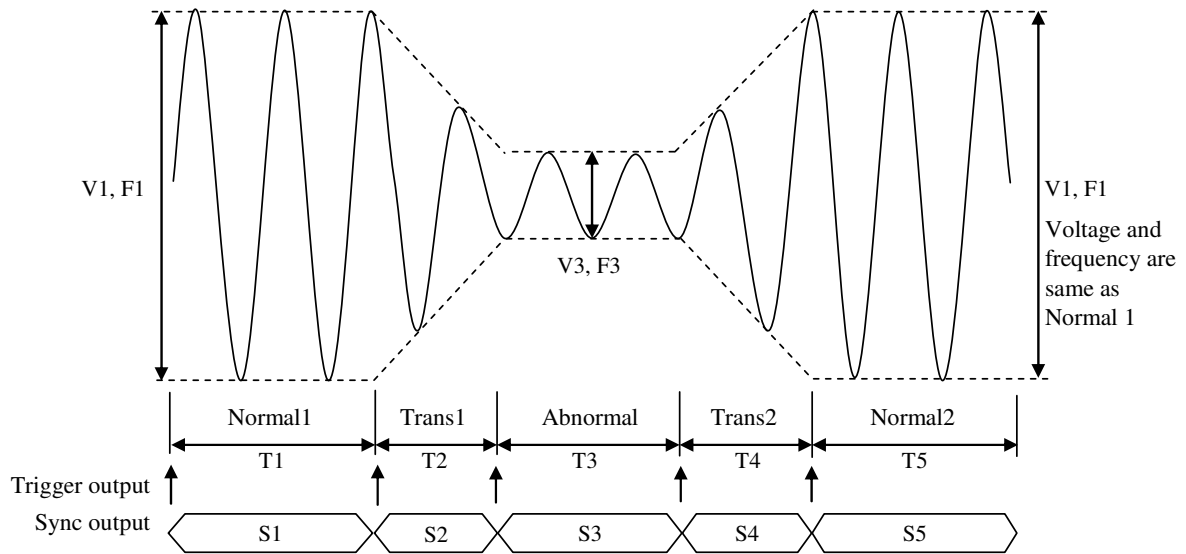

Figure 4-11 Simulation Function Steps

Table 4-5 Simulation Function Steps and Settable Step Parameters

Step	Initial	Normal 1	Trans 1	Abnormal	Trans 2	Normal 2
Step time	—	T1	T2	T3	T4	T5
AC voltage	V0	V1	—	V3	—	—(=V1)
Frequency	F0	F1	—	F3	—	—(=F1)
Start phase	ON/OFF P0	ON/OFF P1	—	ON/OFF P3	—	ON/OFF P5
Stop Phase	ON/OFF Q0	ON/OFF Q1	—	ON/OFF Q3	—	ON/OFF Q5
Trigger output	—	ON/OFF	ON/OFF	ON/OFF	ON/OFF	ON/OFF
Sync code output	S0	S1	S2	S3	S4	S5

Note: "—" means that this parameter cannot be set.

■ Start phase (Start Phs)

ON or OFF can be selected for the start phase. When ON is selected, the step starts at the specified start phase. When OFF is selected, the step starts at the phase in which the previous step ended. When selecting ON, a numerical entry box in which you can specify the start phase opens.

The start phase can be set at the Normal 1, Normal 2, and Abnormal steps. For other steps, the start phase is fixed to OFF and cannot be specified.

■ Stop phase (Stop Phs)

ON or OFF can be selected for the stop phase. When ON is selected, the step ends at the specified stop phase. If the phase is not the specified stop phase after the Step Time elapsed, the execution continues the output of that step until reaching the specified Stop Phase, then performs the next step. When OFF is selected, the step transitions to the next step when the Step Time has elapsed regardless of the phase. When selecting ON, a numerical entry box in which you can specify the stop

phase opens.

The stop phase can be set at the Normal 1, Normal 2, and Abnormal steps. For other steps, the stop phase is fixed to OFF and cannot be specified.

■ Trigger output (Trig Out)

State output to CONTROL I/O connector. This specifies whether the trigger output presents when the step starts. Polarity and pulse width of the trigger output complies with the trigger output setting (see 4.3.5). At the Initial Step, the trigger output cannot be specified and thus no trigger is output.

■ Step sync code output (Code)

State output to CONTROL I/O connector. Code to output while the execution of the step, which is specified by 2-bit H/L. The step synchronization code can be specified also at the Initial Step.

■ Repeat (Repeat)

You can set to repeat the simulation in a series from the Normal 1 step to the Normal 2 step. Specify the ON or OFF of repeat and the repeat count. When Repeat is set to ON, the simulation repeats for the specified count. The simulation in a series is repeated for the repeat count + 1. Setting the repeat count to zero (0) means an infinite count. When Repeat is set to OFF, the KP3000S executes the simulation only once and finishes it without performing the repeat operation.

4.3.3 Output Examples Using Simulation Function

■ Voltage dip simulation

In this simulation, the 50 Hz 100 V power source repeats a 70 % voltage dip for 0.5 seconds three times at 10-second intervals as shown in Figure 4-12. For this case, set so that the total of Normal 1 and Normal 2 Step Times becomes 10 seconds and set the repeat count to 3. Set the Trans 1 and Trans 2 Step Times to zero (Table 4-6).

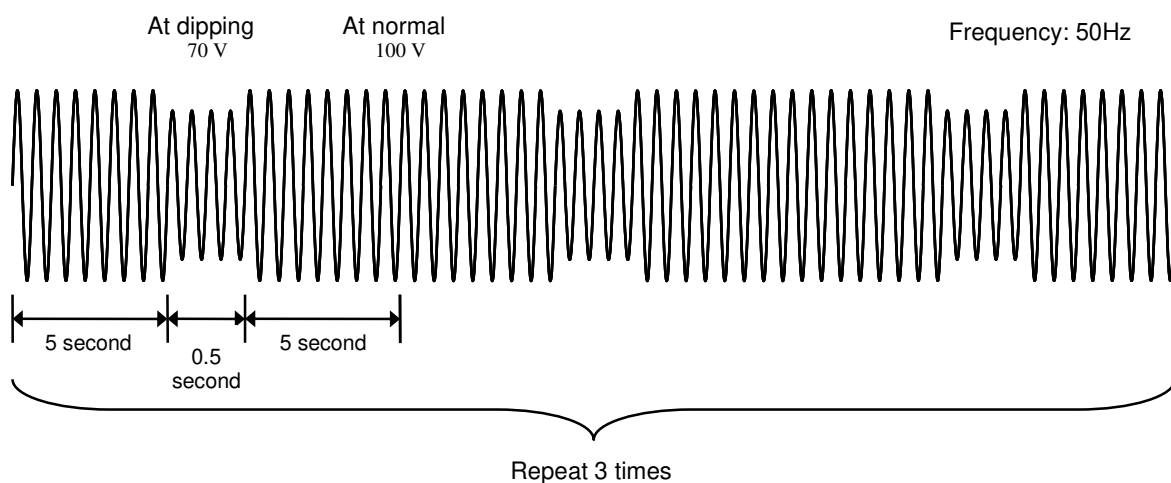

Figure 4-12 Voltage Dip Simulation Example

Table 4-6 Voltage Dip Simulation Edit Example

Step	Initial	Normal 1	Trans 1	Abnormal	Trans 2	Normal 2
Step Time	—	5 s	0 s	0.5 s	0 s	5 s
AC voltage	100 V	100 V	—	70 V	—	—
Frequency	50 Hz	50 Hz	—	50 Hz	—	—
Start phase	OFF	OFF	—	OFF	—	OFF
Stop Phase	OFF	OFF	—	OFF	—	OFF
Repeat count	2 times					

■ Voltage change simulation

In this simulation, the 50 Hz 100 V power source repeats the voltage change three times at 10-second intervals, while the voltage drops to 70 % and then linearly recovers in 0.5 seconds during one cycle as shown in Figure 4-13. For this case, set so that the total of Normal 1 and Normal 2 Step Times becomes 10 seconds and set the repeat count to 3. Set the Trans 1 Step Time to zero (Table 4-7).

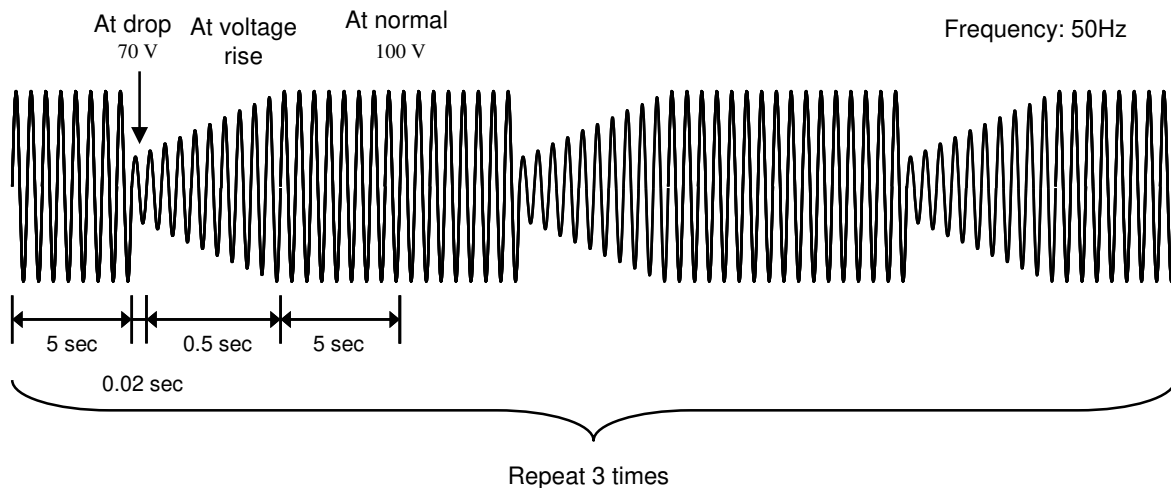
**Figure 4-13 Voltage Change Simulation Example****Table 4-7 Voltage Change Simulation Edit Example**

Step	Initial	Normal 1	Trans 1	Abnormal	Trans 2	Normal 2
Step Time	—	5 s	0 s	0.02 s	0.5 s	5 s
AC voltage	100 V	100 V	—	70 V	—	—
Frequency	50 Hz	50 Hz	—	50 Hz	—	—
Start phase	OFF	OFF	—	OFF	—	OFF
Stop Phase	OFF	OFF	—	OFF	—	OFF
Repeat count	2 times					

4.3.4 Process Flow in a Step

Figure 4–14 shows the process flow in one step. The End operation causes the transition as shown in Figure 4–15.

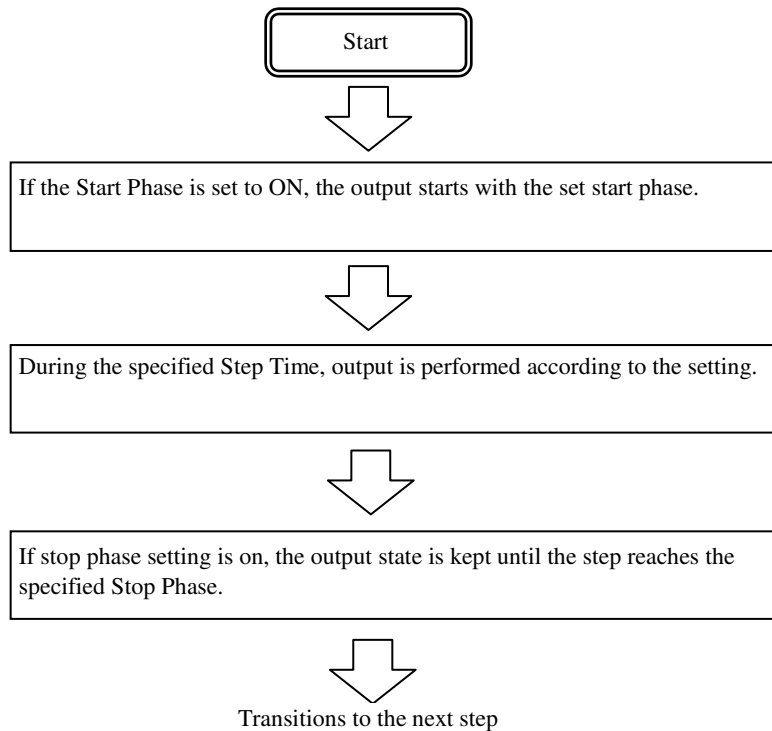

Figure 4-14 Process Flow through Simulation Steps

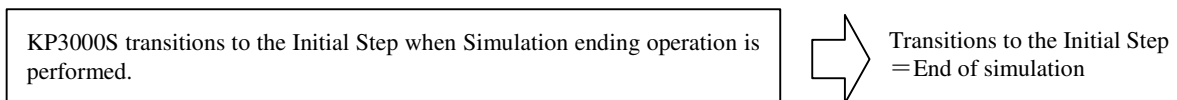

Figure 4-15 Stop Operation

4.3.5 Editing Simulation

- Notes -----
- When the power is turned off, edited contents of the simulation are cleared, and all simulations have the default setting values when it is started next time. To keep the edited contents of simulation, save them in the Simulation Memory (see 4.3.8).
 - When a simulation is loaded from memory, the simulation you are editing is discarded.
 - You can also turn on output on the Simulation Edit View. In this case, the output will be set to the state set in the initial step when Power Fluctuation Testing was last compiled (see 4.3.7).
-

■ Transition to Simulation Edit View

Press the MENU key to open the root menu, then select [Simulation] (see 3.3.1). While the Simulation Control View is displayed, if you push [Edit] soft-key, the execution transitions to the Simulation Edit View.

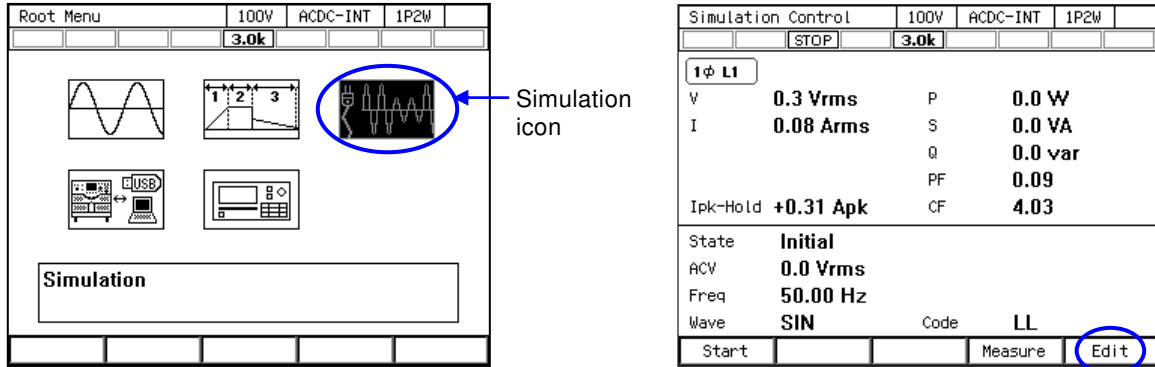

■ Creating (editing) a simulation

1. In the Simulation Edit View, press the [Osc] soft-key, and then select 100 V or 200 V range. To create a new simulation from an existing one, load the existing one (see 4.3.6).

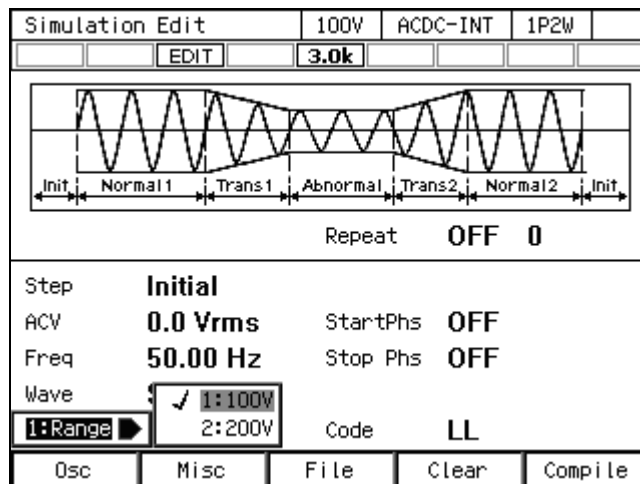

2. Set the parameter of each step. You can move between each step by changing [Step] item.

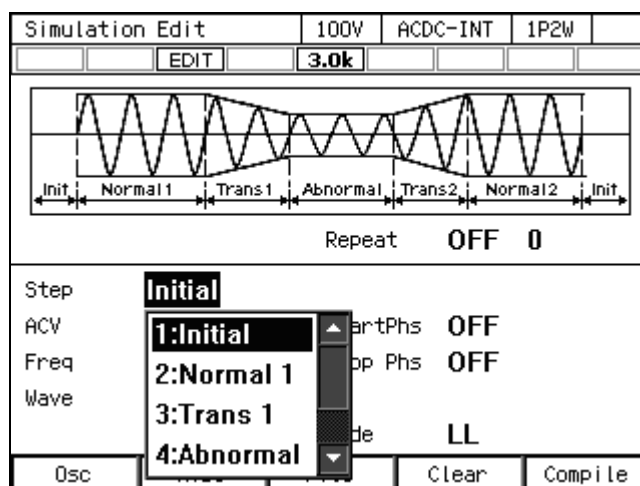

4. Advanced Operation

3. You can select s or ms as the unit of Step Time by selecting [Misc] soft-key → [1: TimeUnit].

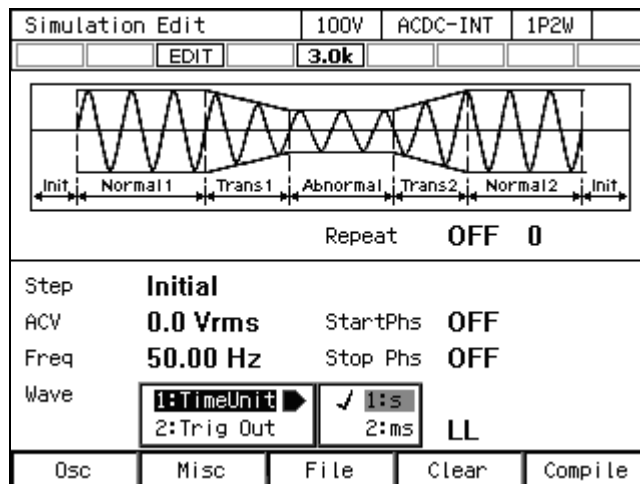

4. You can set polarity of trigger output and pulse width by selecting [Misc] soft-key → [2: Trig Out].

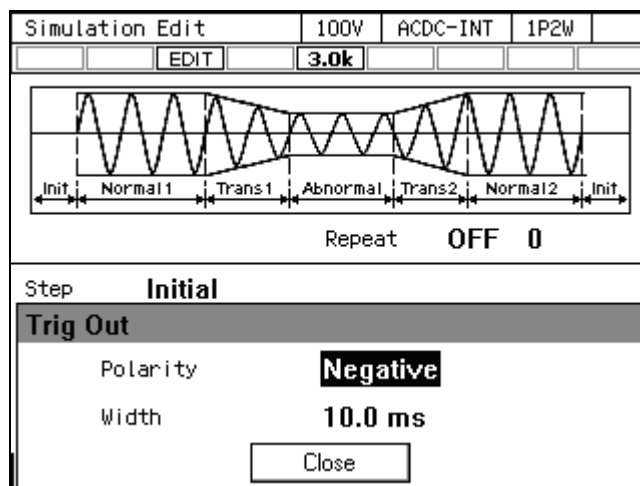

5. Press the [Clear] soft-key to clear all the steps you are editing and return to the factory default.

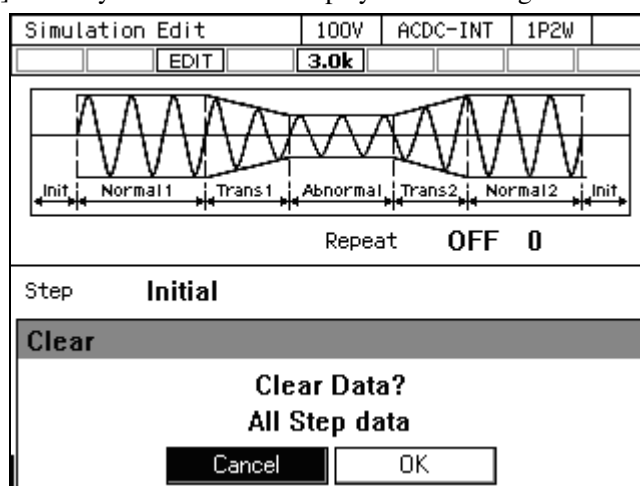

4.3.6 Loading a Simulation

----- Notes -----

- When a simulation is loaded, the simulation you are editing is discarded.
 - Simulation cannot be loaded in the Simulation Control View.
-

■ Load the simulation stored in the internal memory

1. In Simulation Edit View, select [File] soft-key → [2: Recall]. The Simulation Recall View opens.

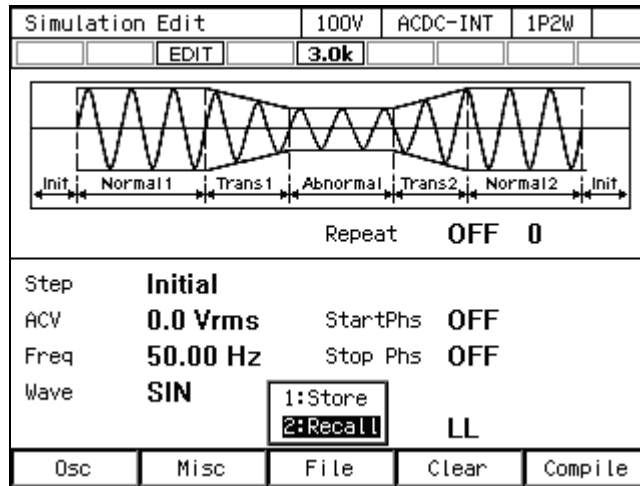

2. In the [From] item, select [1: System].

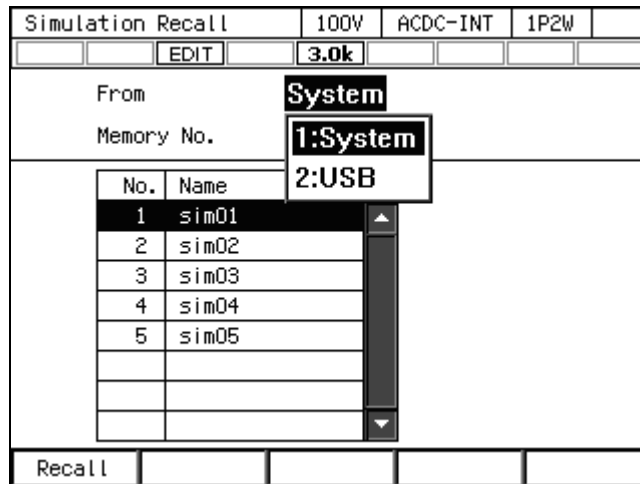

- Specify the memory number of simulation to be loaded in [Memory No.] item, and then push [Recall] soft-key.

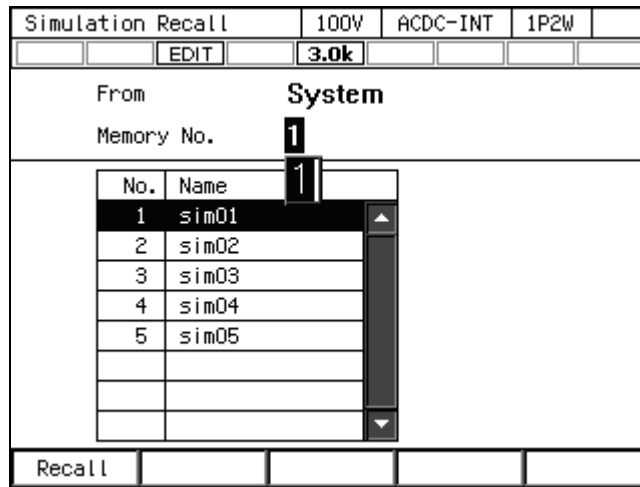

- The confirmation window for loading the simulation opens. Select [OK]. The simulation with the specified memory number is loaded.

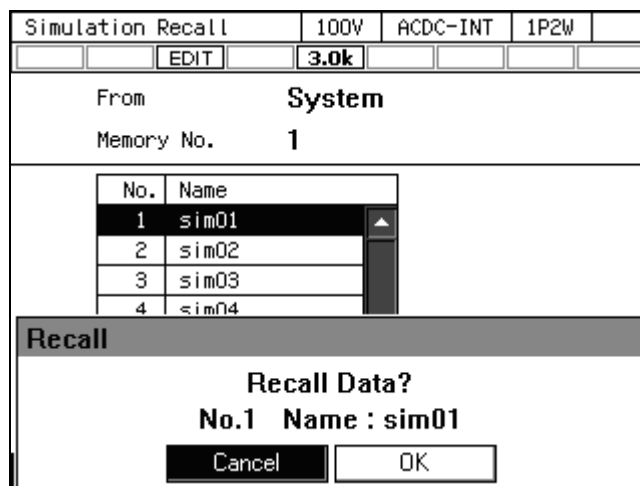

■ Load the simulation stored in the USB memory

For how to connect USB memory to this product, and how to disconnect from this product, see 4.9.

1. In Simulation Edit View, select [File] soft-key → [2: Recall]. The Simulation Recall View opens.

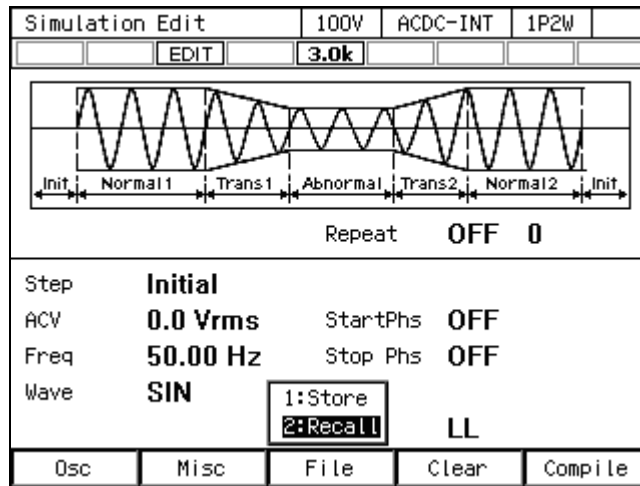

2. In the [From] item, select [2: USB].

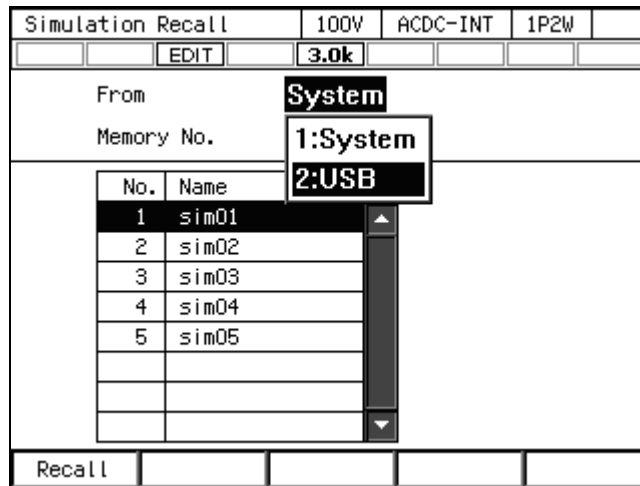

3. In the data list box, select the simulation to load.

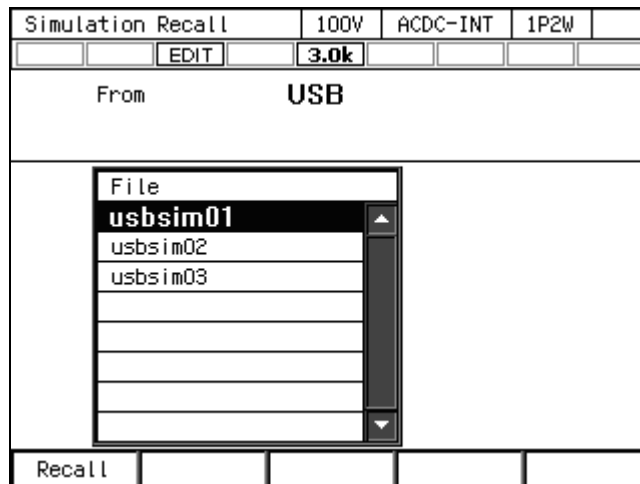

4. Advanced Operation

4. Push the [Recall] soft-key.
5. The confirmation window for loading the simulation opens. Select [OK]. The specified simulation data is loaded.

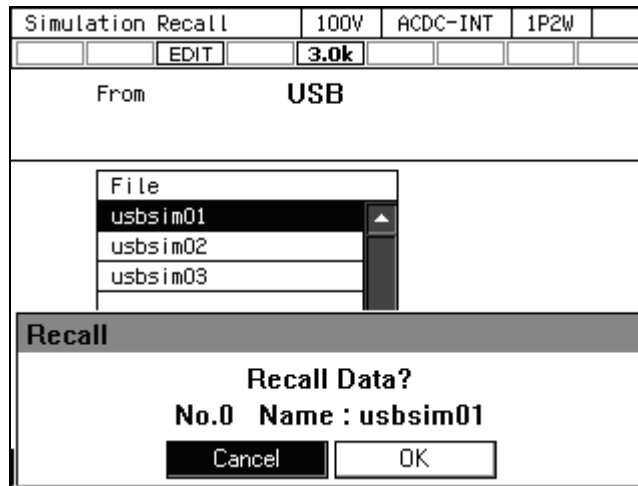

Notes

- The number of simulation data files saved in a USB memory should be 500 or less. If the number of files exceeds this limit, this product cannot recognize the simulation data files in the USB memory.

4.3.7 Executing Simulation

The edited simulation can be executed after converted to executable program by compile operation.

■ Transition to Simulation Edit View

When pushing [Compile] soft-key in the Simulation Edit View, the edited power fluctuation is compiled, and then the screen transitions to Simulation Control View. If output is turned on in the Simulation Edit View, the output transitions to the state set in the initial step, at the same time as compiling.

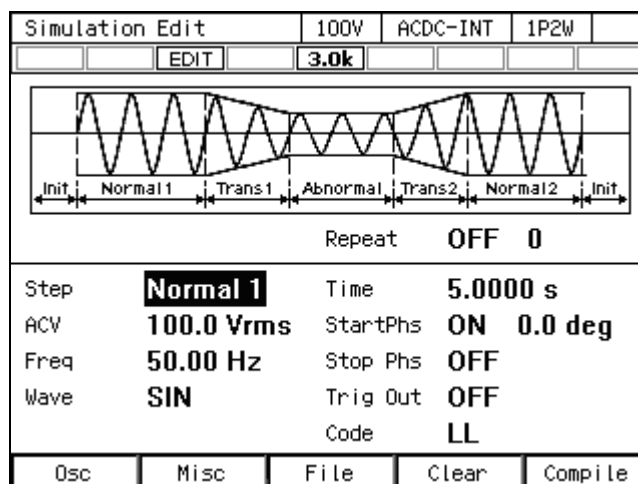

Notes

- If an improper setting is detected during compilation, an error message is displayed and the screen does not transition to the Simulation Control View.

■ Starting/ending a simulation

1. If output is turned off in the Simulation Edit View, the Power Fluctuation Test can be executed when output is turned on in the Simulation Control View. At this point, the output is in the state set in the Initial Step. When a simulation is stopped, the **[STOP]** icon is displayed.

Simulation Control		100V	ACDC-INT	1P2W	
		[STOP]	3.0k		
1φ L1					
V	0.1 Vrms	P	0.0 W		
I	0.04 Arms	S	0.0 VA		
		Q	0.0 var		
		PF	1.00		
Ipk-Hold	-39.20 Apk	CF	4.23		
State	Normal 1	Time	5.0000 s		
ACV	100.0 Vrms	StartPhs	0.0 deg		
Freq	50.00 Hz				
Wave	SIN	Code	LL		
[Start]			[Measure]	[Edit]	

2. Press the **[Start]** soft-key to start the simulation. While the simulation is executed, icon **[RUN]** is displayed.

Simulation Control		100V	ACDC-INT	1P2W	
		[RUN]	3.0k		
1φ L1					
V	100.0 Vrms	P	2750 W		
I	27.51 Arms	S	2750 VA		
		Q	10.0 var		
		PF	1.00		
Ipk-Hold	-39.35 Apk	CF	1.42		
State	Normal 1	Time	5.0000 s		
ACV	100.0 Vrms	StartPhs	0.0 deg		
Freq	50.00 Hz				
Wave	SIN	Code	LL		
	[Stop]				

4. Advanced Operation

- When [Stop] soft-key is pushed while simulation is executed, the execution transitions to the output that is set in the Initial Step, and then simulation is terminated.

Simulation Control		100V	ACDC-INT	1P2W
STOP		3.0k		
1ϕ L1				
V	0.1 Vrms	P	0.0 W	
I	0.04 Arms	S	0.0 VA	
		Q	0.0 var	
		PF	1.00	
Ipk-Hold	-39.35 Apk	CF	3.67	
State	Initial			
ACV	0.0 Vrms			
Freq	50.00 Hz			
Wave	SIN	Code	LL	
Start			Measure	Edit

----- Notes -----

- In the output off state, the simulation cannot be started.
- The output on/off phase setting is invalid for the Simulation.

■ Returning to Simulation Edit View

If you push the [Edit] soft-key, the execution transitions back to the Simulation Edit View.

4.3.8 Saving Simulation

----- Notes -----

- Simulation cannot be saved in the Simulation Control View.

■ Saving the simulation in the internal memory

1. In the Simulation Edit View, press the select the [File] soft-key - [1: Store]. The Simulation Store View opens.

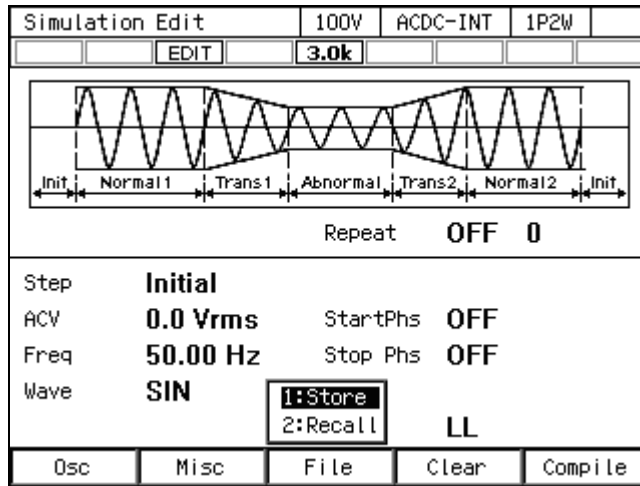

2. In the [To] item, select [1: System].

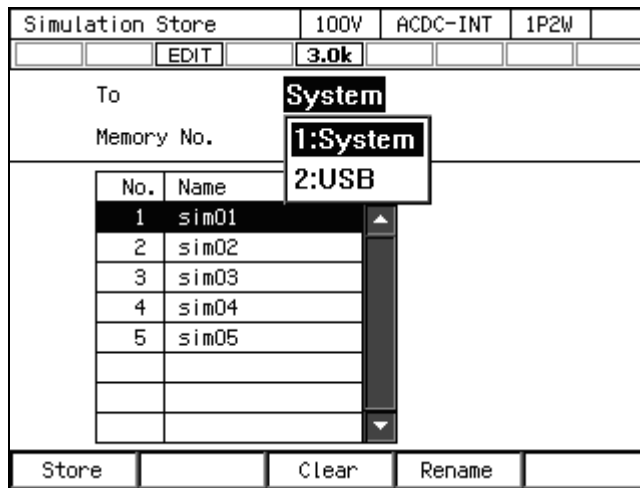

3. Specify the memory number of location to save in [Memory No.] item, and then push [Store] soft-key.

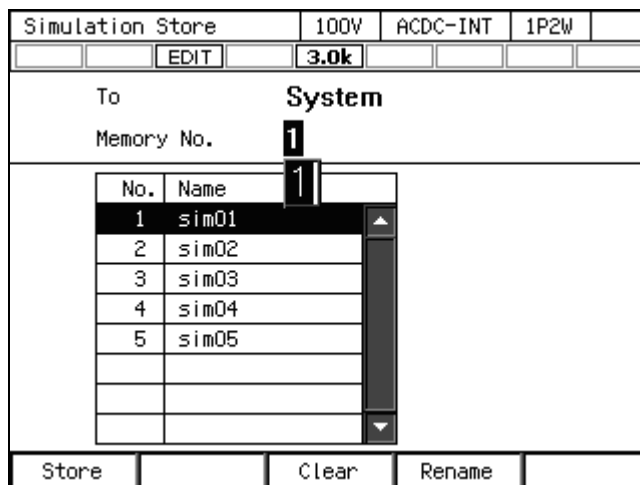

4. A window to confirm the save name opens. Enter the name, and then select [OK]. For how to enter a string, see 3.3.6.

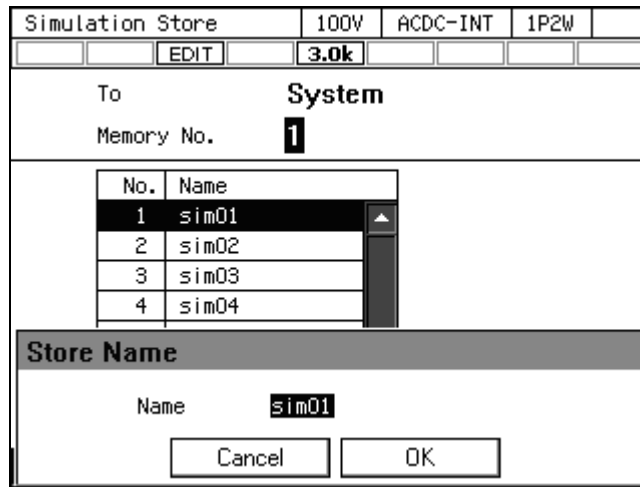

■ Saving the simulation in the USB memory

For how to connect USB memory to this product, and how to disconnect from this product, see 4.9.

1. In the Simulation Edit View, press the select the [File] soft-key - [1: Store]. The Simulation Store View opens.

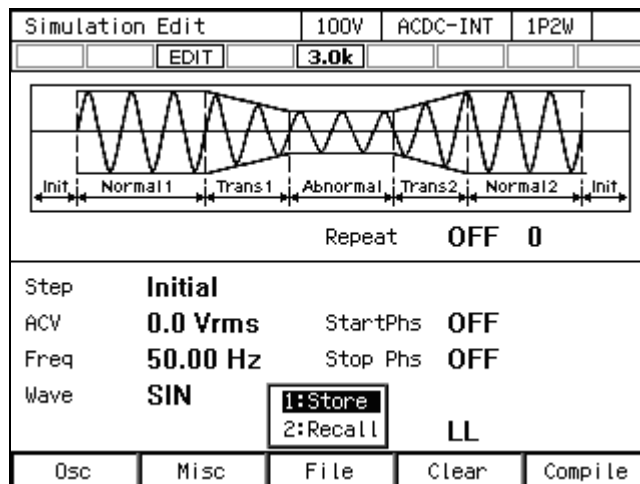

- In the [To] item, select [2: USB].

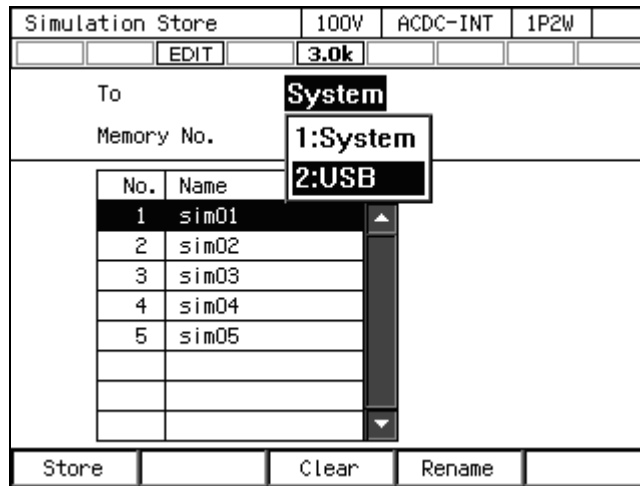

- Push [New] soft-key to save for the first time. To overwrite the existing data, select the data to be overwritten in data list box, and push [Store] soft-key.

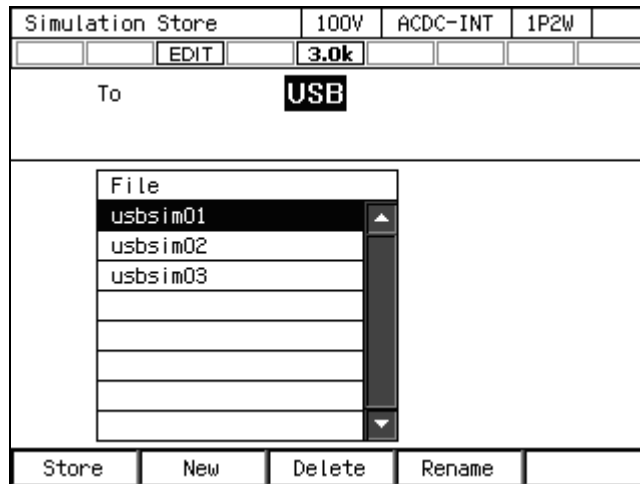

- A window to confirm the save name opens. Enter the name, and then select [OK]. For how to enter a string, see 3.3.6.

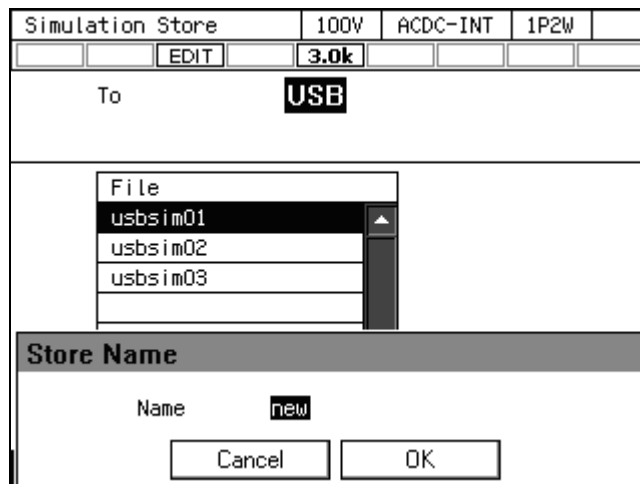

----- Notes -----

- The number of simulation data files saved in a USB memory should be 500 or less. If the number of files exceeds this limit, the product cannot recognize the simulation data files in the USB memory.

4.3.9 Clear/Rename Simulation

■ Clearing/renaming a simulation saved in internal memory

1. In the Simulation Edit View, press the select the [File] soft-key - [1: Store]. The Simulation Store View opens.

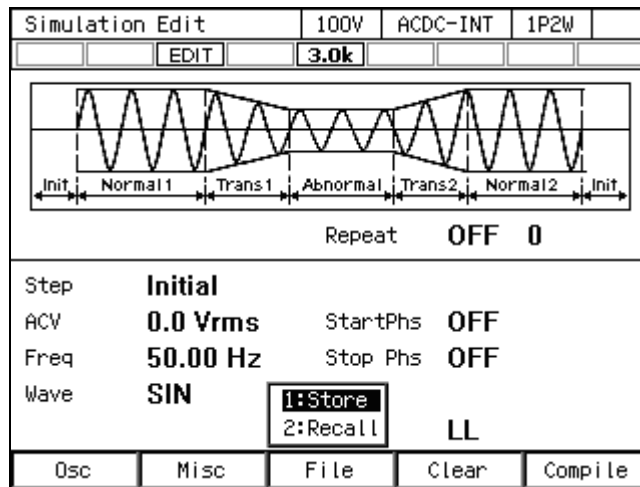

2. In the [To] item, select [1: System].

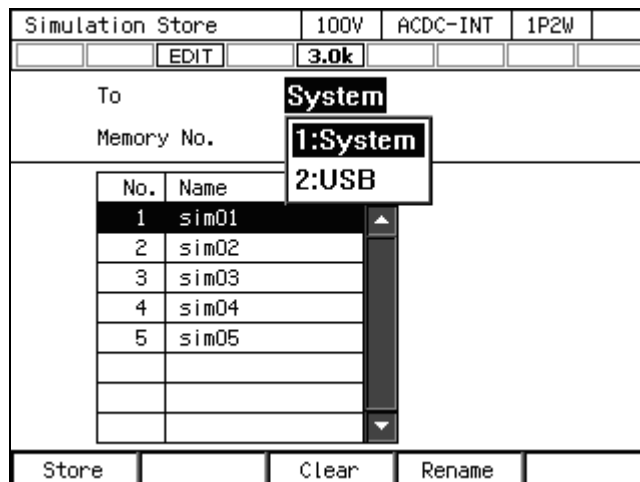

3. Set the number of memory to be operated in [Memory No.] item.

Simulation Store	100V	ACDC-INT	1P2W
	EDIT	3.0k	
To System			
Memory No. 1			
No.	Name		
1	sim01		
2	sim02		
3	sim03		
4	sim04		
5	sim05		
Store Clear Rename			

4. To clear, push [Clear] soft-key. Confirmation message is displayed. Select [OK]. In the cleared number of the memory, the simulation data at factory shipment is stored.

Simulation Store	100V	ACDC-INT	1P2W
	EDIT	3.0k	
To System			
Memory No. 1			
No.	Name		
1	sim01		
2	sim02		
3	sim03		
4	sim04		
Clear			
Clear Data?			
No.1 Name : sim01			
Cancel		OK	

- To rename, push [Rename] soft-key. Rename window opens. Enter a new name and then select [OK]. For how to enter a string, see 3.3.6.

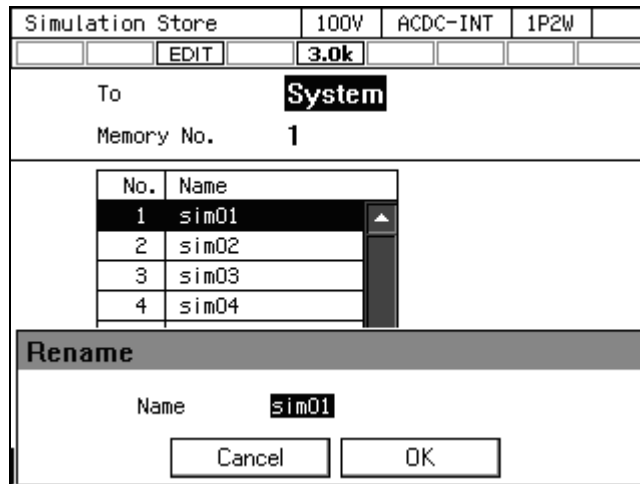

■ Erasing/renaming a simulation saved in USB memory

For how to connect USB memory to this product, and how to disconnect from this product, see 4.9.

- In the Simulation Edit View, press the select the [File] soft-key - [1: Store]. The Simulation Store View opens.

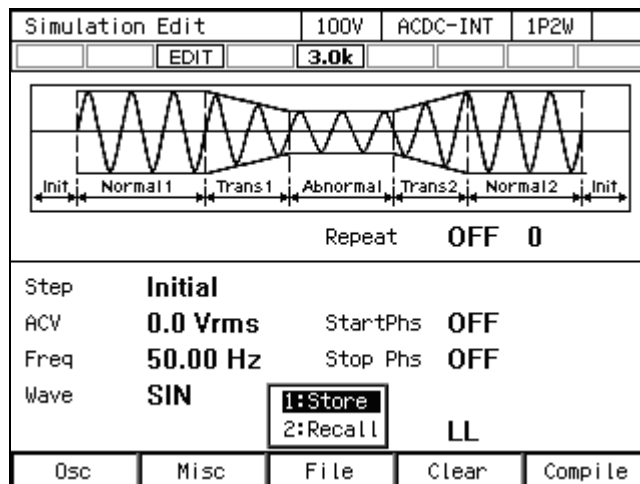

2. In the [To] item, select [2: USB].

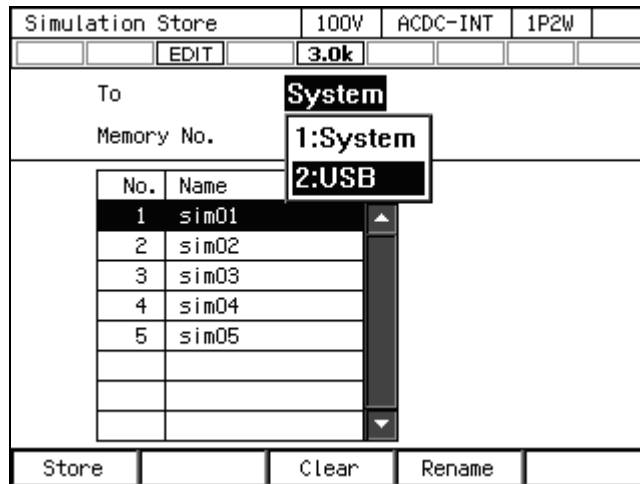

3. Select the data that is the target of the operation in the data list box.

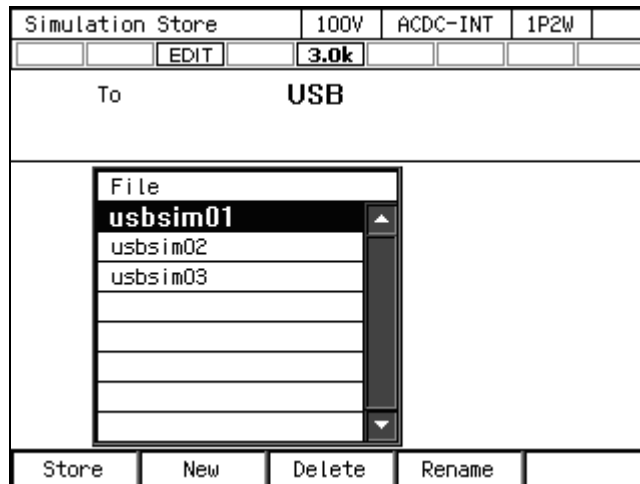

4. To clear, push [Delete] soft-key. Confirmation message is displayed. Select [OK]. The corresponding file in USB memory is deleted.

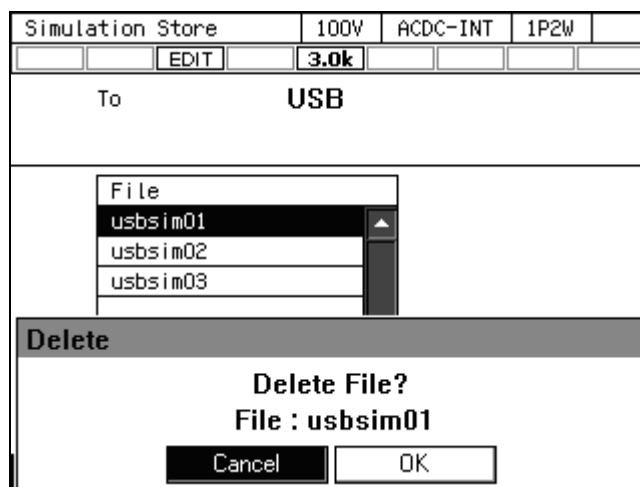

- To rename, push [Rename] soft-key. Rename window opens. Enter a new name and then select [OK]. For how to enter a string, see 3.3.6.

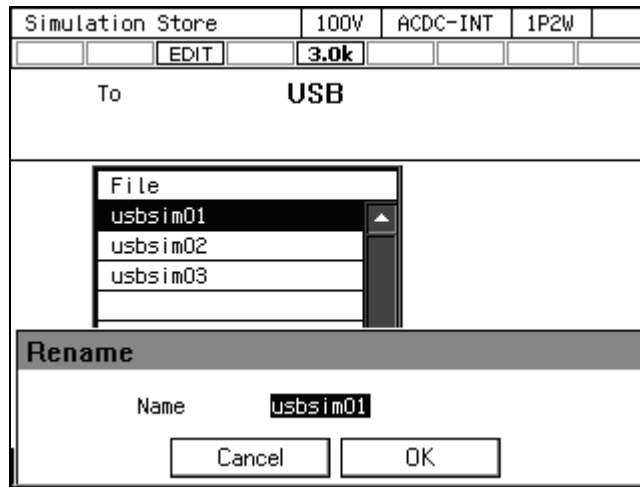

4.3.10 Set so as the Simulation Function is Selected at Power-on

You can set so as the Simulation function is selected at power-on.

■ Operation procedure

- Press the MENU key to move to the root menu, then select [System]. The system setting window opens.

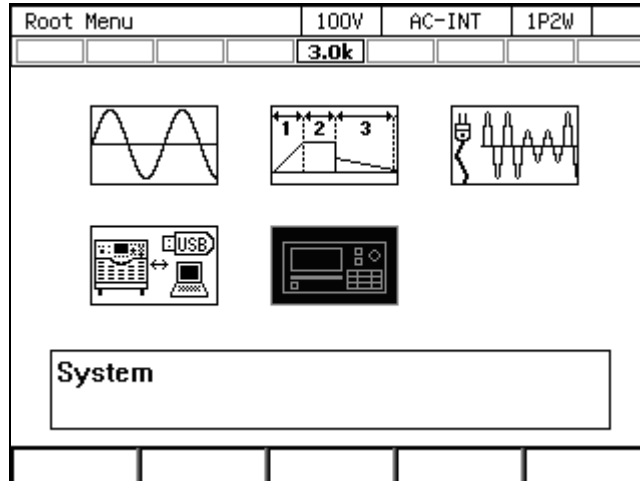

2. In [PwOn Mode] item, Select [3: Sim].

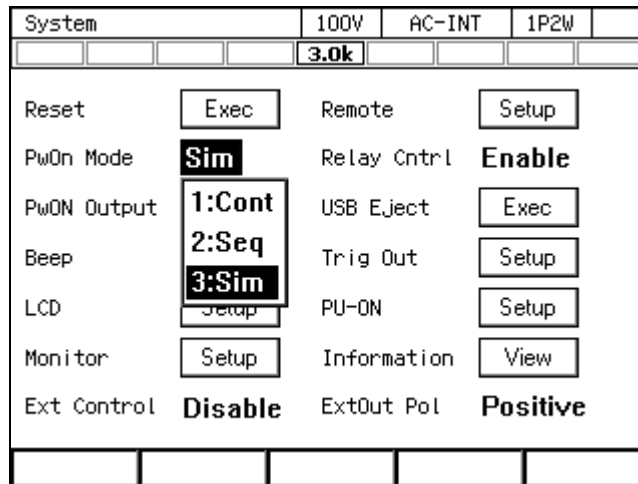

----- Notes -----

- To set so as to Continuous function is selected at power-on, select [1: Cont] in [PwOn Mode] item.
-

4.3.11 Simulation Control by External Control

External control enables to start/stop a simulation and to recall the memory. For details, see 4.18.

4.3.12 Screen Overview

The Simulation function screen is broadly divided to the Simulation Edit View and the Simulation Control View. The Simulation Edit View opens when you select the power fluctuation testing (Simulation) icon from the root menu. After pushing [Compile] soft-key in Simulation Edit View, the screen transitions to the Simulation Control View.

----- Notes -----

- You cannot transition to root menu by pushing the MENU key in the Simulation Control View. To transition to the root menu, first move to the Simulation Edit View and then push the MENU key.
-

■ Simulation Edit View

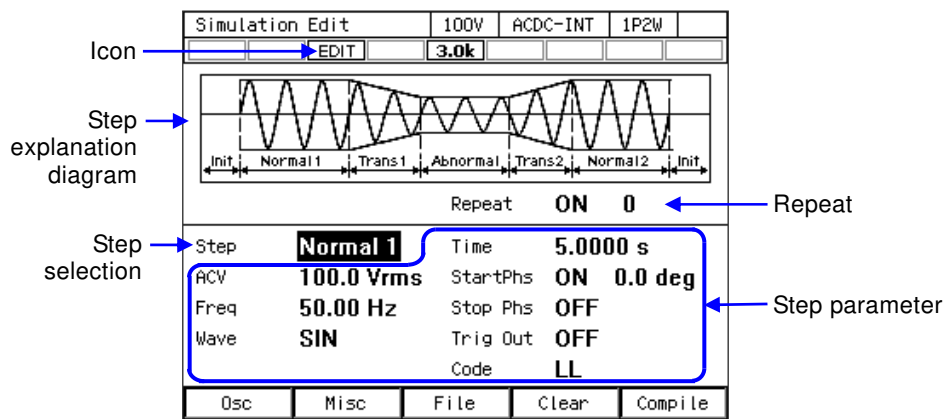

Figure 4-16 Simulation Edit View

■ Simulation Control View (output off state, simulation stopped)

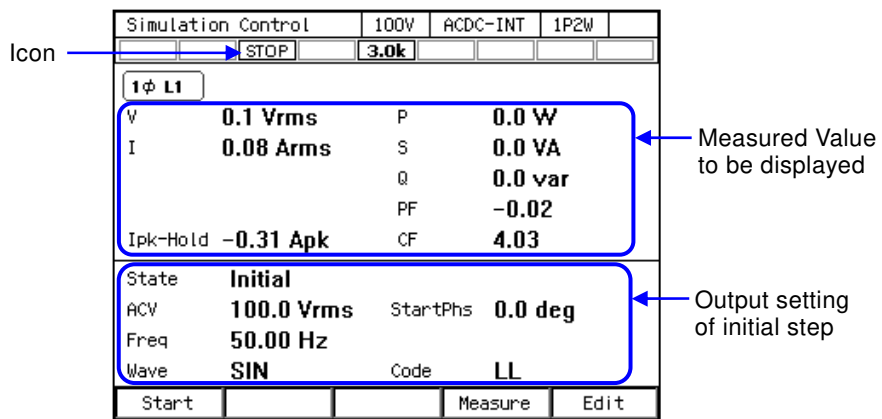

Figure 4-17 Simulation Control View (Output Off State, Simulation Stopped)

■ Simulation Control View (output on state, simulation running)

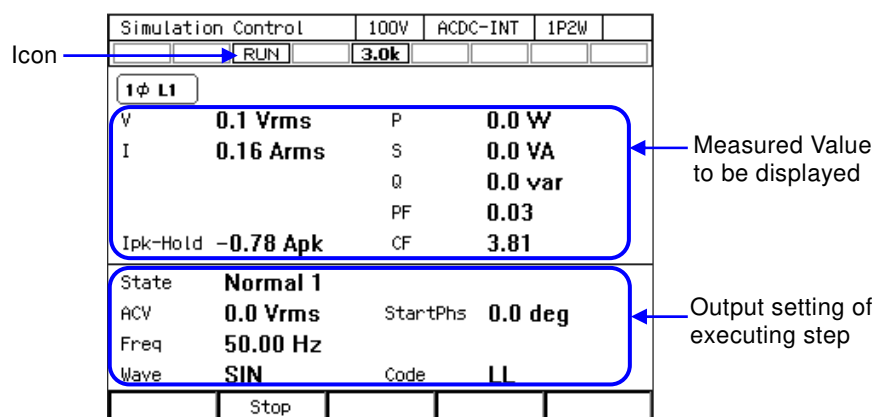

Figure 4-18 Simulation Control View (Output On State, Simulation Running)

■ Simulation Control View (output on state, simulation stopped)

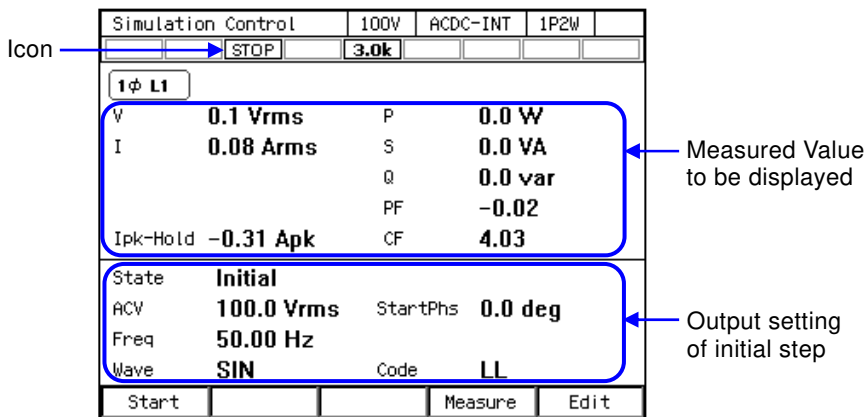

Figure 4-19 Simulation Control View (Output On State, Simulation Stopped)

4.4 Measuring Harmonic Current

4.4.1 Harmonic current

Some electric devices of AC power input have its input current waveform greatly distorted from the sine wave. When the power input section uses a capacitor input type rectifier circuit, the input current typically distorts as shown in Figure 4–20. A waveform distorted like this contains many harmonic components. If a current with many harmonic components is supplied to the power line in high volume, the line voltage is distorted, causing problems such as malfunction of devices and overheated transformer which may result in accidents.

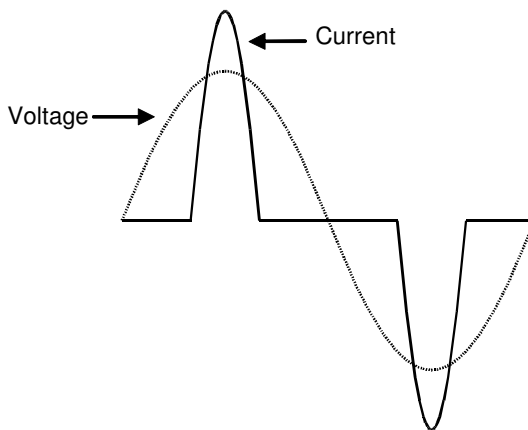

Figure 4-20 Current Waveform Containing Many Harmonic Components

4.4.2 Basics

Harmonic current measurement function is available only for the Continuous function, AC-INT, and set frequency of 50 Hz or 60 Hz.

The harmonic current components up to order 40 are displayed as the RMS and a percentage to fundamental wave component.

----- Notes -----

- The Harmonic current measurement function does not support the standard tests defined by organizations such as IEC. Use this function for a preliminary testing.

4.4.3 Measured Value Display Method

■ Operation procedure

1. In the Continuous function, select the [Measure] soft-key → [4: Harmonic].

Continuous		100V	AC-INT	1P2W
		3.0k		
1φ L1	V	86.6 Vrms	P	2058 W
	I	23.77 Arms	S	2058 VA
			Q	8.6 var
			PF	1.00
	Ipk-Hold	-42.16 Apk	CF	1.73
1φ All	Freq		ACV	300.0 Vpp
	Wave			
Osc	Measure	Misc	Limiter	

2. The view opens populated with the measured harmonic components of order 1 to 10.

Harmonic Current View		100V	AC-INT	1P2W
		3.0k		
1φ L1	Harmonic	I (rms)	n th / 1st	
	1st	23.56 A	100.0 %	
	2nd	0.01 A	0.0 %	
	3rd	2.62 A	11.1 %	
	4th	0.00 A	0.0 %	
	5th	0.94 A	4.0 %	
	6th	0.00 A	0.0 %	
	7th	0.48 A	2.1 %	
	8th	0.00 A	0.0 %	
	9th	0.29 A	1.2 %	
	10th	0.00 A	0.0 %	
			Prev	Next

- Press the [Next] soft-key to display the measured values for order 11 to 20. Press the [Prev] soft-key to return to the original view. Switch the view in the same manner for the measured values over order 21.

Harmonic Current View		100V	AC-INT	1P2W
3.0k				
1φ L1	Harmonic	I (rms)	n th / 1st	
	21th	0.05 A	0.2 %	
	22th	0.00 A	0.0 %	
	23th	0.05 A	0.2 %	
	24th	0.00 A	0.0 %	
	25th	0.04 A	0.2 %	
	26th	0.00 A	0.0 %	
	27th	0.03 A	0.1 %	
	28th	0.00 A	0.0 %	
	29th	0.03 A	0.1 %	
	30th	0.00 A	0.0 %	
			Prev	Next

- Press the CANCEL key to return to the Continuous function view.

4.5 Measuring Inrush Current

4.5.1 Inrush Current

On an electric device using a capacitor input type rectifier circuit for power input, an excessive current in comparison to the Normal state may flow for a short period of time immediately after the start of power supply. This current is called inrush current. If such a big current flows to the power line, the supply voltage may drop due to the impedance of the power line. Therefore, the inrush current is restricted below a certain level in some standards.

Figure 4-21 shows the inrush current waveform of a small electric drill. The inrush current flows at 14 A peak, which is about four times of the rated current of 3.5 A.

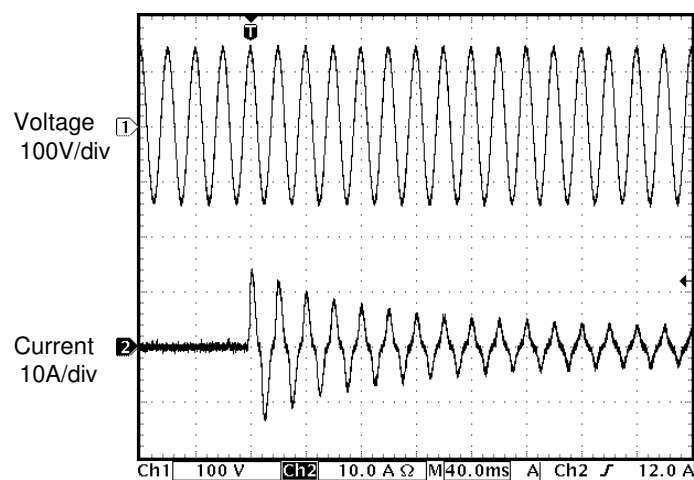

Figure 4-21 Inrush Current Example

It is necessary for an electric device with a large inrush current to use a power source with a sufficient current supplying capability. With a power source that cannot supply a sufficient inrush current, some electric devices may not start as they are not supplied with necessary power.

This product has the ability to supply peak current up to four times of the RMS rating. You can measure the maximum inrush current value using the current peak-hold function of the product.

4.5.2 Basics

- Output current peak-hold function holds either a positive or negative peak value, whichever is larger in absolute value.
- Current peak-hold value is displayed in all of the Average, RMS, and Peak measurement views in the Normal View.
- Clearing function for the current peak-hold value is provided. The clear operation clears the current peak-hold value (all phases) to 0 Apk.

----- Notes -----

- The peak hold value starts to update again immediately after the clear operation. The clear operation may not turn the current peak-hold value to 0 Apk even when no current is being output, because of noise or other reasons.

4.5.3 Measurement Method

■ Operation procedure

1. Before turning on the output, clear the current peak-hold value. Following two methods are available.
 - (a) Shortcut operation: **SHIFT** + **+/-**
 - (b) Select the [Measure] soft-key → [2: Measure]. Hover the cursor over [Exec] of the [Ipk-H Clr] item and press the ENTER key.

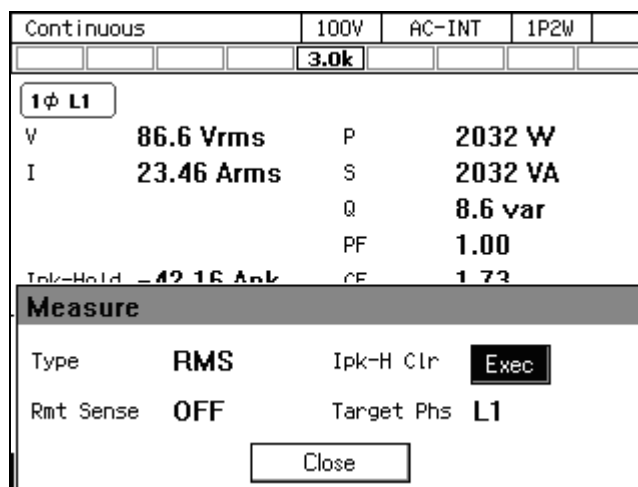

2. Turn on the power switch of the object to be measured.
3. Turn on the output.
4. Read current peak-hold value (Ipk-Hold). This is the maximum inrush current value.

4.5.4 Measurement Tips

- You can see the difference among inrush currents at each power-on phase by changing the phase setting at output on (see 3.4.7) before turning on the output.
- The object inrush current cannot be measured correctly when the maximum peak current exceeds the one that can be supplied by this product or the peak current limiter is activated.
- Correct peak value measurement may not be accomplished for a very small load impedance, such as when there is a short at the output terminal.

4.6 Using Clipped Sine Wave

Clipped sine wave is the waveform that has its sine wave peak clipped as shown in Figure 4–22. This product can select the clipped sine wave as the output waveform.

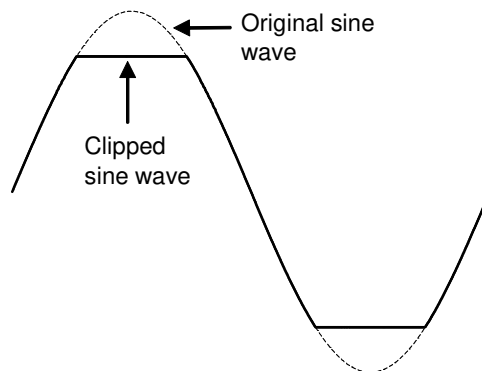

Figure 4-22 Clipped Sine Wave

The depth of clip is set using the crest factor or clip ratio. Each of them is defined by the following expression. The clip ratio is set in percentage.

$$\text{Crest factor} = \text{Peak value} / \text{RMS value}$$

$$\text{Clip ratio} = \text{Clipped sine wave peak value} / \text{Original sine wave peak value}$$

As shown in Table 4-8, the output voltage setting method differs depending on the clip depth setting method. Therefore, a clip ratio less than 100 % makes the output voltage smaller than the setting.

Table 4-8 Different Output Voltage Settings Depending on Clip Depth Setting Method

Clip Depth Setting Method	Output Voltage Setting Method
Crest factor	Sets the RMS of the clipped waveform
Clip ratio	Sets the RMS of the sine wave before clipping

----- Notes -----

- When the clipped sine wave is output in the AC mode, the clip of the output waveform may be tilted by the DC component remove function in the AC mode. To avoid this, switch to the ACDC mode.

■ Operation procedure

1. In the [Wave] item, select [CLP].

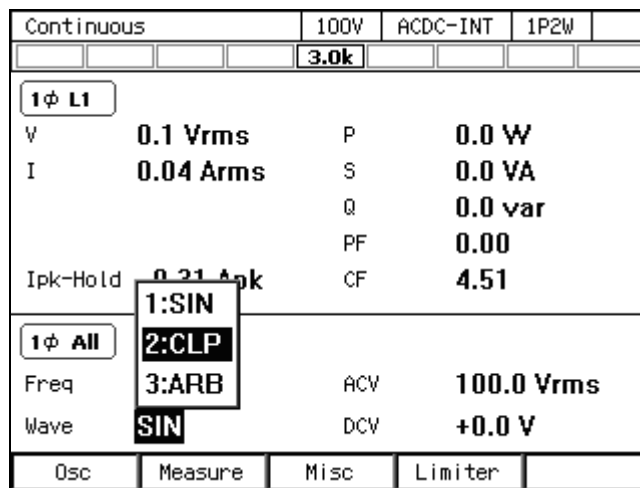

2. Move the cursor to [Select], then select it. The clipped sine wave setting window opens.

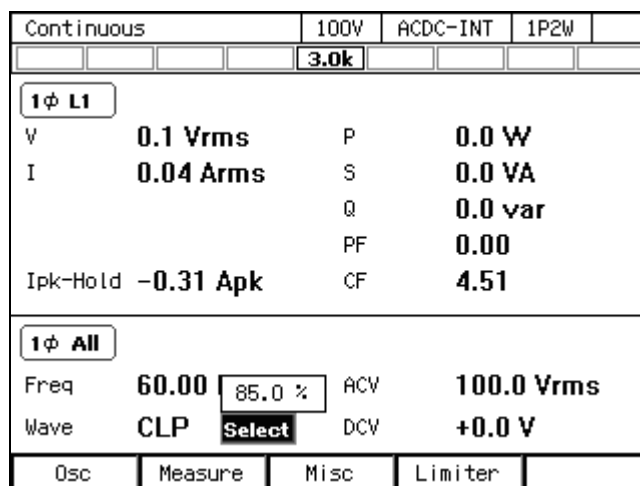

3. In the [No.] item, select the clipped sine wave to load.

Continuous	100V	ACDC-INT	1P2W
	3.0k		
1φ L1			
V	0.1 Vrms	P	0.0 W
I	0.03 Arms	S	0.0 VA
		Q	0.0 var
		PF	0.00
Clipped sine			
No	CLP1		
Type	1:CLP1		
Clip	2:CLP2		<input type="button" value="Save"/>
	3:CLP3		

4. In the [Type] item, select [1: Clip] (clip ratio) or [2: CF] (crest factor).

Continuous	100V	ACDC-INT	1P2W
	3.0k		
1φ L1			
V	0.1 Vrms	P	0.0 W
I	0.04 Arms	S	0.0 VA
		Q	0.0 var
		PF	0.00
Clipped sine			
No	CLP1		
Type	Clip		
Clip	1:Clip		<input type="button" value="Save"/>
	2:CF		

5. In the [CF] (or [Clip]) item, enter the crest factor (or clip ratio).

Continuous	100V	ACDC-INT	1P2W
	3.0k		
1φ L1			
V	0.1 Vrms	P	0.0 W
I	0.04 Arms	S	0.0 VA
		Q	0.0 var
		PF	0.00
Clipped sine			
No	CLP1		
Type	CF		
CF	1.20		<input type="button" value="Save"/>
	<input type="button" value="Close"/>		

6. To save the set content into memory, move the cursor to [Save], then press the ENTER key.

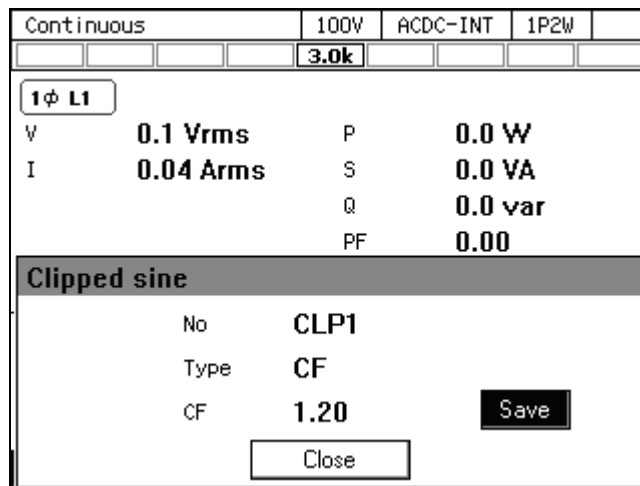

7. Move the cursor to [Close], then press the ENTER key. The clipped sine wave setting window closes.

----- Notes -----

- Executing [Save] saves all the settings from CLP1 to CLP3 into the internal memory.
 - Settings not saved in the internal memory are lost when the power is turned off.
 - The clip ratio setting value and the crest factor setting value are held independently of each other. The setting value switch as the Type is changed. Each setting value is saved per waveform when the settings are saved into the internal memory.
 - The clipped sine wave memory cannot be cleared (to the factory defaults). Manually set to the factory default settings of Clip = 100 %, CF = 1.41, Type = Clip, then save them.
-

4.7 Outputting Arbitrary Waveform

4.7.1 Basics

Arbitrary waveform can be selected as the output waveform with this product. Using the control software Wave Designer in the optional CD-ROM, you can create, edit, and transfer arbitrary waveforms to this product's internal memory through the USB interface. Alternatively, you can create and save the arbitrary waveform data in a USB memory and then transfer it to the internal memory of this product through this product's panel operation. Up to 16 types of arbitrary waveforms can be saved in the internal memory. For Wave Designer, see the instruction manual of the control software.

----- Notes -----

- Arbitrary waveform cannot be created and edited through the panel operation of this product.
-

4.7.2 Arbitrary Waveform Creation Procedure

See the instruction manual of the control software.

4.7.3 Arbitrary Waveform Creation Example

See the instruction manual of the control software.

4.7.4 Transferring Arbitrary Waveform

■ Transfer procedure using Wave Designer

See the instruction manual of the control software.

■ Transfer procedure using USB memory

1. Save the waveform data file (extension ARB) created with Wave Designer, the control software (Optional), to the NF_TOOLNF_KPARB_DATA folder of the USB memory.

Notes

- This product does not support the double-byte characters (e.g. kanji, hiragana). The file name should consist of one byte alphanumeric characters.
- When the NF_TOOLNF_KPARB_DATA folder does not exist in your USB memory, first connect the memory to this product. The NF_TOOL folder is automatically created containing sub folders within it.

2. Connect the USB memory that has the waveform data to this product.

3. Press the MEMORY key, or press the MENU key to move to the root menu and then select [Memory], to move to the Memory View. Select ARB Copy.

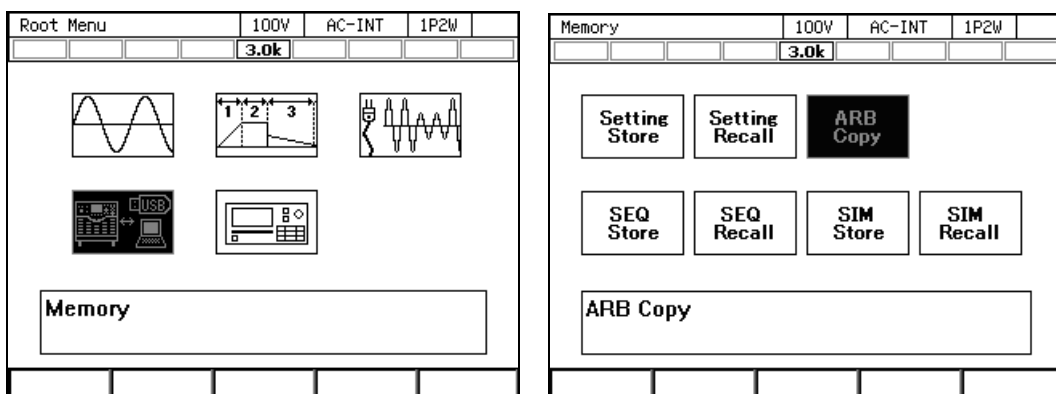

4. In the [Direction] item, select [2: USB→SYS].

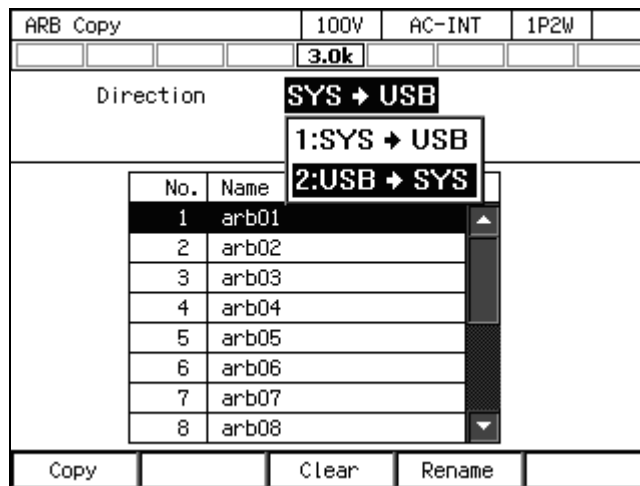

5. In the [Memory No.] item, specify the transfer destination internal memory number.

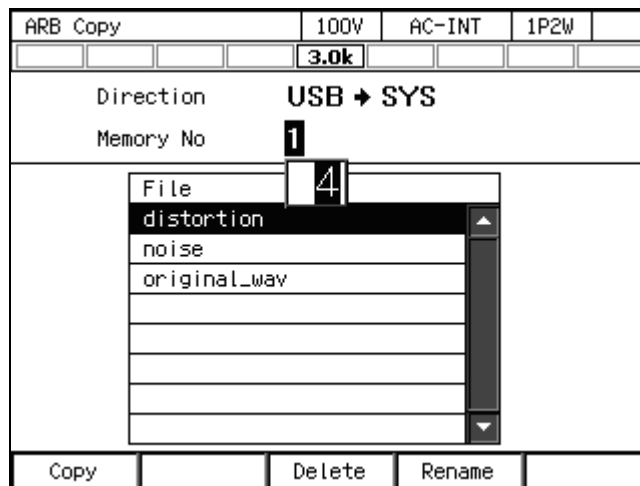

6. From the data list box, select the arbitrary waveform to transfer.

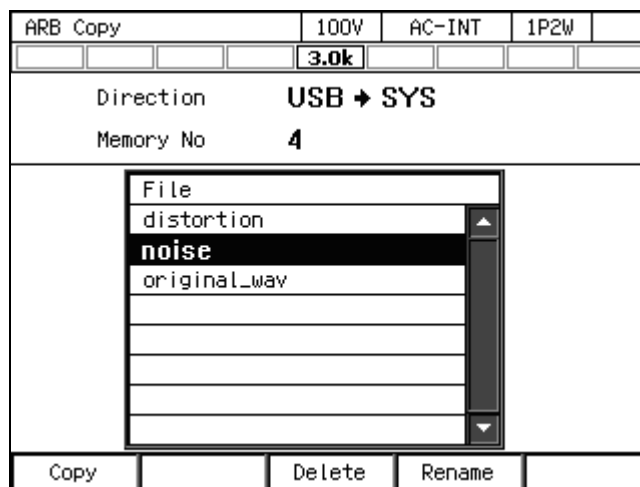

7. Push the Copy soft-key. The [Copy] window opens.

ARB Copy	100V	AC-INT	1P2W
	3.0k		
Direction	USB → SYS		
Memory No	4		
File	distortion noise original_wav		
Copy			
Name	noise		
Cancel		OK	

8. In the [Name] item, enter the arbitrary waveform data name. Or, leave it as populated which is same as the file name in the USB memory.

ARB Copy	100V	AC-INT	1P2W
	3.0k		
Direction	USB → SYS		
Memory No	4		
File	distortion noise original_wav		
Copy			
Name	noise		
Cancel		OK	

9. Move the cursor to [OK], then press the ENTER key. The window is closed.

ARB Copy	100V	AC-INT	1P2W
	3.0k		
Direction	USB → SYS		
Memory No	4		
File	distortion noise original_wav		
Copy			
Name	noise		
Cancel		OK	

4.7.5 Outputting Arbitrary Waveform

■ Operation Method

1. In the [Wave] item, select [ARB].

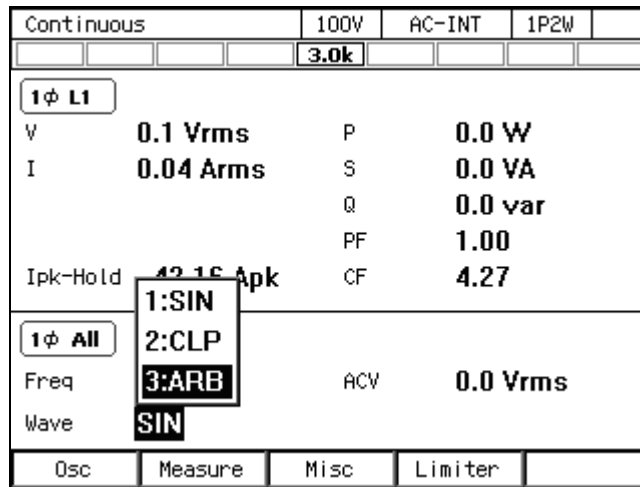

2. Move the cursor to [Select], then select it. The setting window for the arbitrary waveform opens.

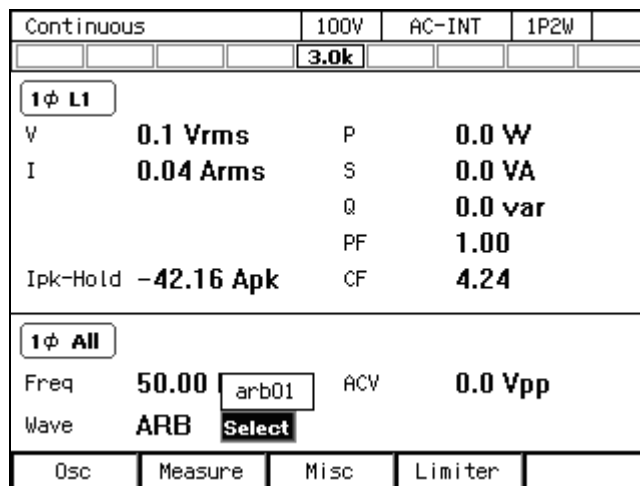

3. From the data list box, select the arbitrary waveform to output.

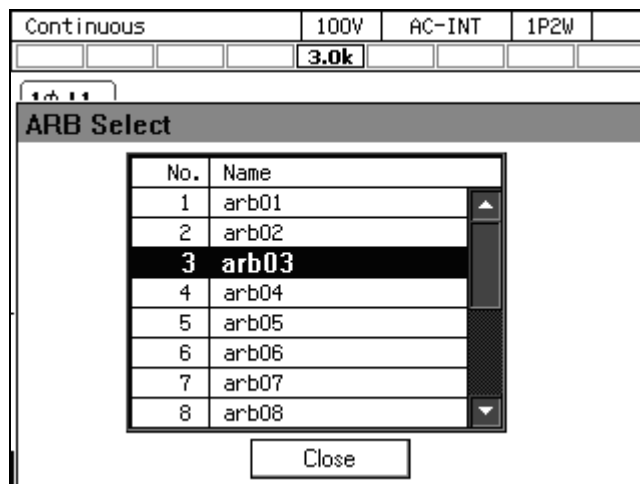

4. Move the cursor to [Close], then press the ENTER key. The arbitrary waveform setting window closes.
5. Set the frequency and output voltage. Turn on the output. Set the arbitrary waveform output voltage in the [ACV] item using Peak-to-Peak value.

----- Notes -----

- ACV is the setting relative to the full scale amplitude of the arbitrary waveform data. When the arbitrary waveform data amplitude is not at full scale, the output voltage amplitude becomes smaller than the ACV setting.
-

4.8 Using Memory Function

Using the Memory function, you can access this product's internal memory and USB memory to save, load, clear, and rename the basic setting, arbitrary waveform, sequence, and simulation.

■ Opening the Memory View

1. Press the MENU key to move to the root menu, then select [Memory] (or press the MEMORY key on the Continuous function screen).

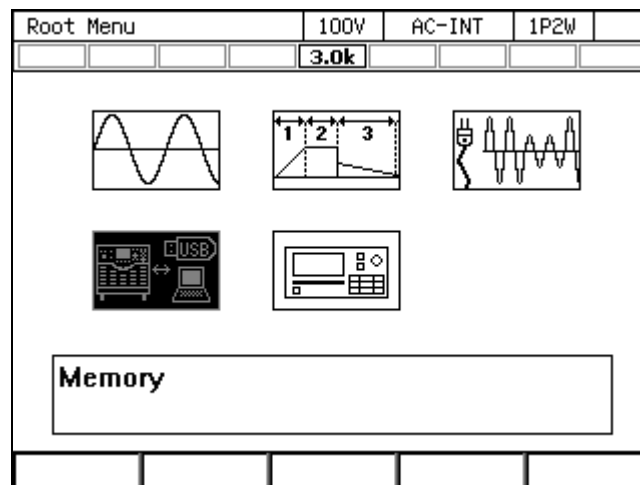

2. The Memory View opens.

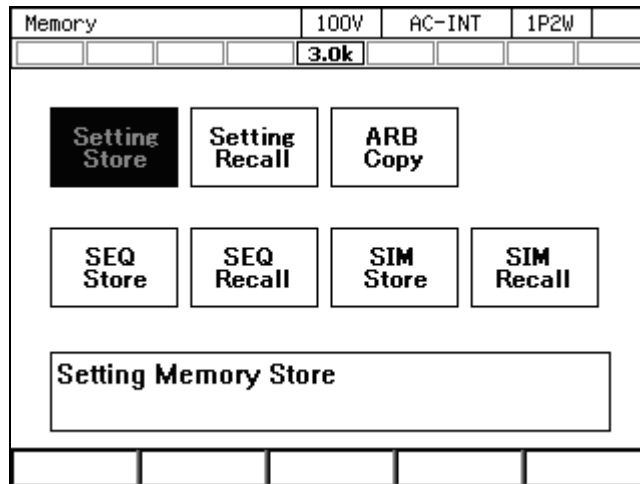

4.8.1 Basic Setting Memory

The Basic Setting Memory collectively stores the output-related settings in the Continuous function (e.g. AC/DC mode, signal source, output range, AC setting, DC setting, current limiter, setting range limit). User is required to perform some operations to save these settings into the Basic Setting Memory. Both the internal and USB memories can be selected as the Basic Setting Memory.

There are 31 internal Basic Setting Memories for each output phase configuration from No. 0 to No. 30. The memory No. 0 stores the factory defaults. The internal memory No. 1 settings are loaded at power-on of this product. User can save the settings to the memories from No. 1 to No. 30. Clearing a Basic Setting Memory resets it to the factory defaults (same as the one of No. 0). Clearing a Basic Setting Memory in the USB memory deletes the applicable file in the USB memory.

For the set content saved in the Basic Setting Memory and factory defaults, see *10.24*.

Notes

- The Basic Setting Memory content cannot be copied directly between the internal and USB memories. To copy them, load them first, then save to a new destination.
- No overwrite confirmation message is displayed when you attempt to save under the same name as for the data that exists on the USB memory.
- The number of basic setting data files saved in a USB memory should be 500 or less. If the number of files exceeds this limit, the product cannot recognize the basic setting data files in the USB memory.

■ Saving to a Basic Setting Memory (how to save the output-related settings in the Continuous function)

1. Press the MEMORY key on the Continuous function screen or select [Memory] from the root menu to move to the Memory View.
2. Select Setting Store.

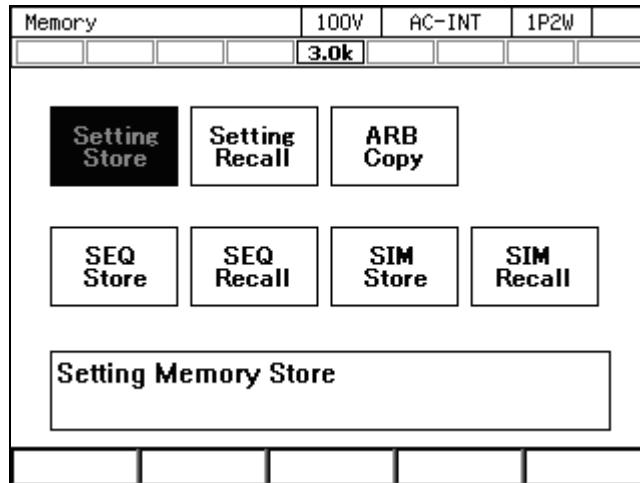

3. For the [To] item, select the destination [1: System] (internal memory) or [2: USB] (USB memory).

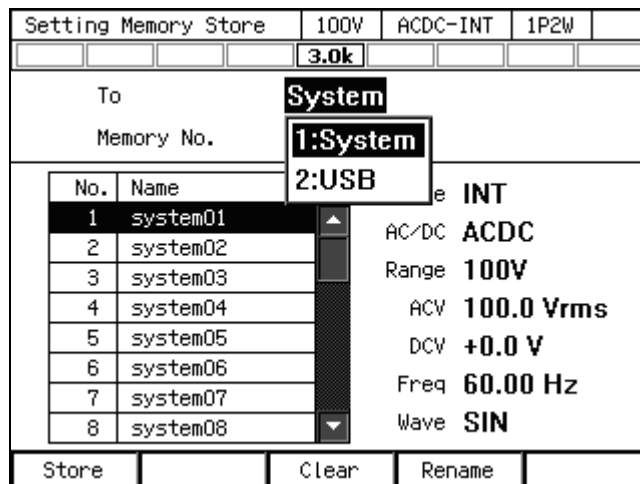

4. Specify the destination.
 - (a) For the internal memory, specify the destination memory number in the [Memory No.] item, then press the [Store] soft-key.

4. Advanced Operation

- (b) In the case of USB memory, push [New] soft-key to save for the first time. To overwrite the existing data, select the data to be overwritten in data list box, and push [Store] soft-key.

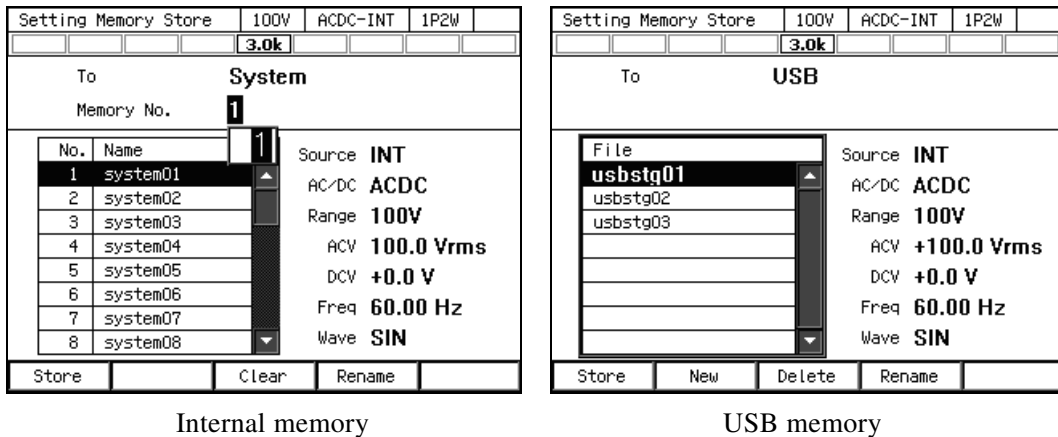

Internal memory

USB memory

5. A window to confirm the save name opens. Enter the name, and then select [OK]. For how to enter a string, see 3.3.6.

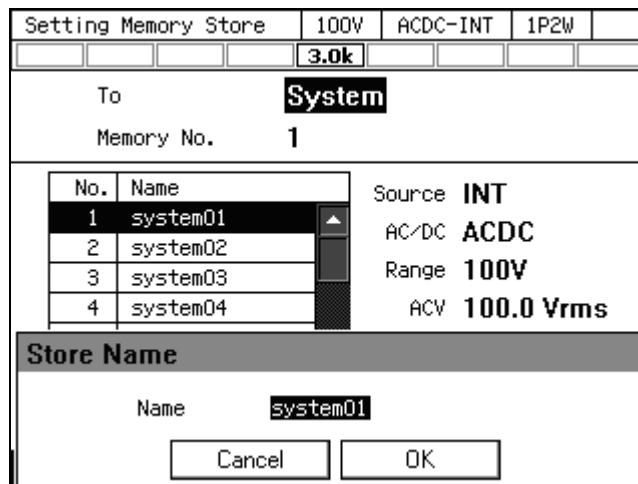

■ Loading from a Basic Setting Memory

1. In the Memory View, select [Setting Recall].

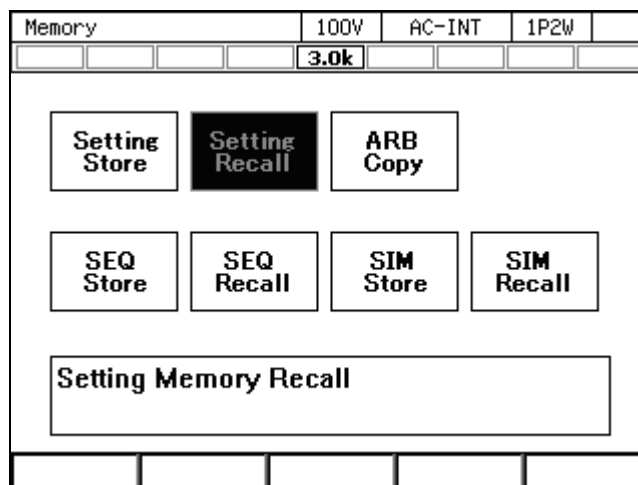

2. In the [From] item, select the source [1: System] (internal memory) or [2: USB] (USB memory).

Setting Memory Recall		100V	AC-INT	1P2W
3.0k				
From		System		
Memory No.		1: System		
		2: USB		
No.	Name	Source		
1	system01	INT		
2	system02	AC/DC	ACDC	
3	system03	Range	100V	
4	system04	ACV	100.0 Vrms	
5	system05	DCV	+0.0 V	
6	system06	Freq	60.00 Hz	
7	system07	Wave	SIN	
8	system08			
Recall		Factory		

3. Specify the data to load.

- (a) For the internal memory, specify the memory number in the [Memory No.] item, then press the [Recall] soft-key.
- (b) For the USB memory, in the data list box, select the data to load, then press the [Recall] soft-key.

Setting Memory Recall		100V	AC-INT	1P2W
3.0k				
From		System		
Memory No.		1		
No.	Name	Source		
1	system01	INT		
2	system02	AC/DC	ACDC	
3	system03	Range	100V	
4	system04	ACV	100.0 Vrms	
5	system05	DCV	+0.0 V	
6	system06	Freq	60.00 Hz	
7	system07	Wave	SIN	
8	system08			
Recall		Factory		

Internal memory

Setting Memory Recall		100V	AC-INT	1P2W
3.0k				
From		USB		
File				
usbstg01		Source	INT	
usbstg02		AC/DC	ACDC	
usbstg03		Range	100V	
		ACV	+100.0 Vrms	
		DCV	+0.0 V	
		Freq	60.00 Hz	
		Wave	SIN	
Recall		Factory		

USB memory

4. In the confirmation window that opens, select [OK].

Setting Memory Recall		100V	AC-INT	1P2W
3.0k				
From		USB		
File				
usbstg01		Source	INT	
usbstg02		AC/DC	ACDC	
usbstg03		Range	100V	
		ACV	+100.0 Vrms	
		DCV	+0.0 V	
		Freq	60.00 Hz	
		Wave	SIN	
Recall				
Recall Data?				
No.0 Name : usbstg01				
Cancel		OK		

■ Clearing, erasing, or renaming a Basic Setting Memory

1. In the Memory View, select [Setting Store].

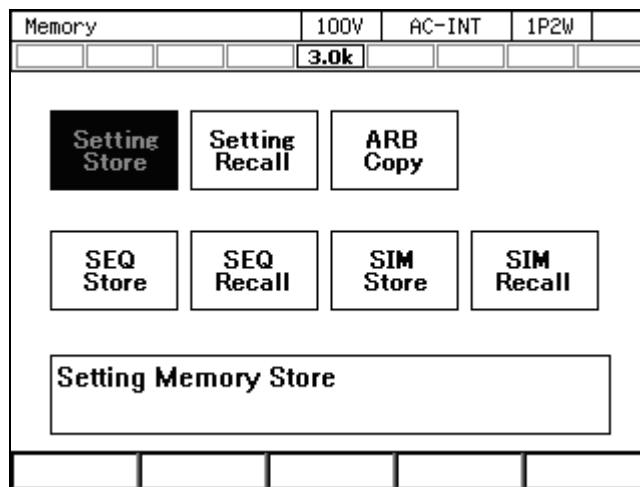

2. In the [To] item, select the object to operate [1: System] (internal memory) or [2: USB] (USB memory).

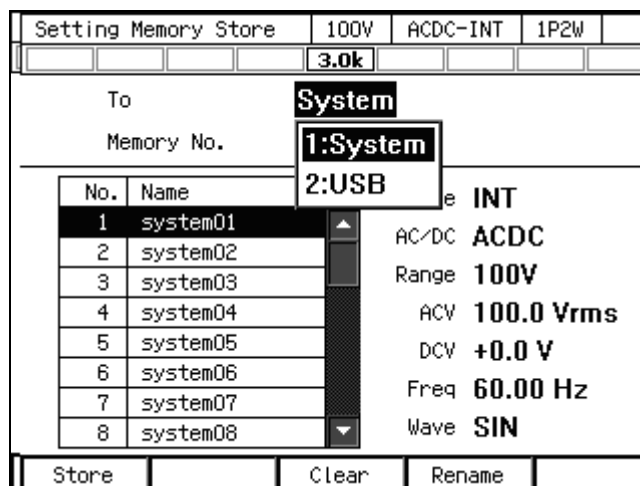

3. Specify the data to operate.
 - (a) For the internal memory, specify the memory number in the [Memory No.] item.
 - (b) For the USB memory, in the data list box, select the data.

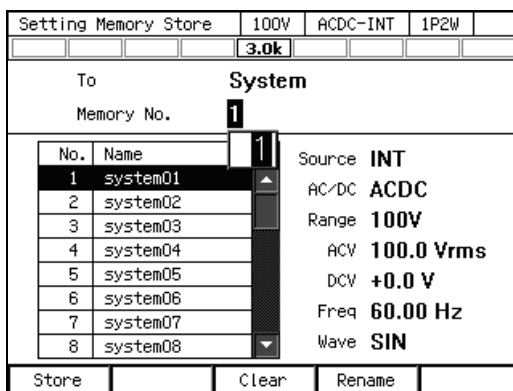

Internal memory

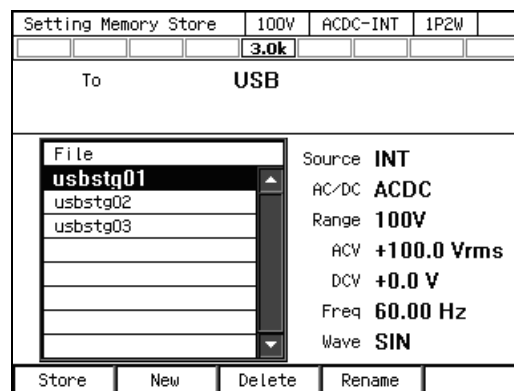

USB memory

4. To clear/delete, push [Clear]/[Delete] soft-key. Confirmation message is displayed. Select [OK]. Clearing the internal memory resets the data to the factory default (same as the one of the internal memory No. 0). Erasing the basic setting data in the USB memory deletes the applicable file.

Setting Memory Store	100V	AC-INT	1P2W
	3.0k		
To	System		
Memory No.	1		
No.	Name	Source	INT
1	system01	AC/DC	ACDC
2	system02	Range	100V
3	system03	ACV	100.0 Vrms
4	system04		
Clear			
Clear Data?			
No.1 Name : system01			
Cancel		OK	

5. To rename, push [Rename] soft-key. Rename window opens. Enter a new name and then select [OK]. For how to enter a string, see 3.3.6.

Setting Memory Store	100V	AC-INT	1P2W
	3.0k		
To	System		
Memory No.	1		
No.	Name	Source	INT
1	system01	AC/DC	ACDC
2	system02	Range	100V
3	system03	ACV	100.0 Vrms
4	system04		
Rename			
Name system01			
Cancel		OK	

■ Loading the factory defaults

1. In the Memory View, select [Setting Recall].

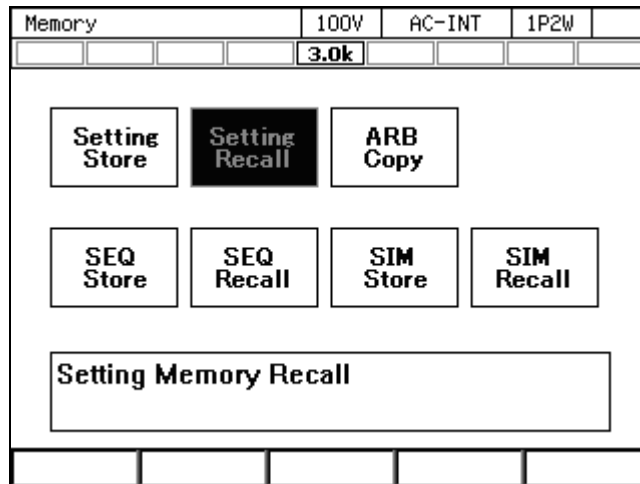

2. In the [From] item, select [System].

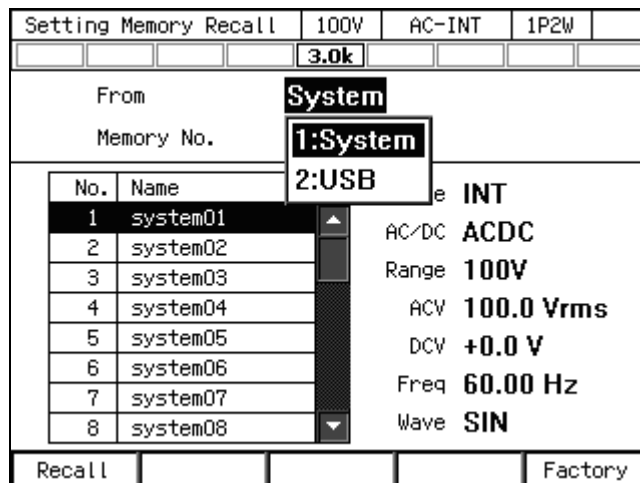

3. Push the [Factory] soft-key. In the confirmation window that opens, select [OK]. The factory default basic setting data are loaded.

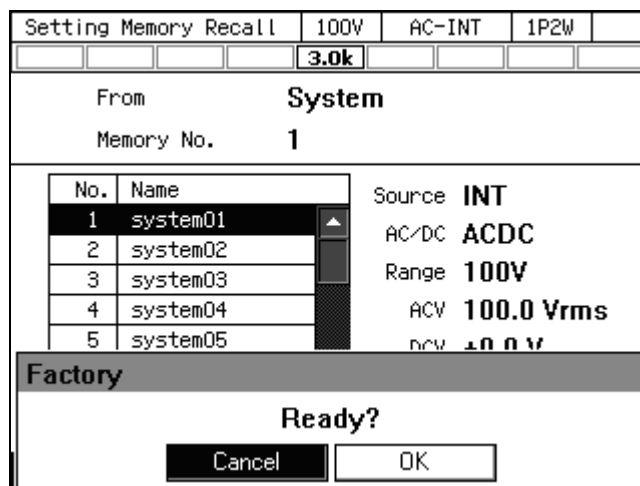

4.8.2 Arbitrary Waveform Memory

The user-created arbitrary waveform data can be saved into the Arbitrary Waveform Memory.

Both the internal and USB memories can be selected as the Arbitrary Waveform Memory. Creation of arbitrary waveform data and saving it to the Arbitrary Waveform Memory are performed using Wave Designer, the control software (Optional). The Memory View enables you to copy the arbitrary waveform data between the internal and USB memories, and clear/rename the Arbitrary Waveform Memory.

The internal memory has 16 Arbitrary Waveform Memories from No. 1 to No. 16. In the factory default, memories from No. 1 to No. 8 are for triangle wave and from No. 9 to No. 16 for square wave. Clearing an Arbitrary Waveform Memory resets its data to the factory default.

Inside the USB memory, the NF_TOOL\NF_KP\ARB_DATA folder is the Arbitrary Waveform Memory.

Notes

- Inside the USB memory, the location that stores the arbitrary waveform data is the NF_TOOL\NF_KP\ARB_DATA folder.
- The number of arbitrary waveform data files saved in a USB memory should be 500 or less. If the number of files exceeds this limit, this product cannot recognize the arbitrary waveform data files in the USB memory.

■ Copying the arbitrary waveform data (from internal memory to USB memory)

The paragraphs below describe how to copy the arbitrary waveform data from the internal memory to the USB memory. For how to copy from the USB memory to the internal memory, see 4.7.4.

1. In the Memory View, select [ARB Copy].

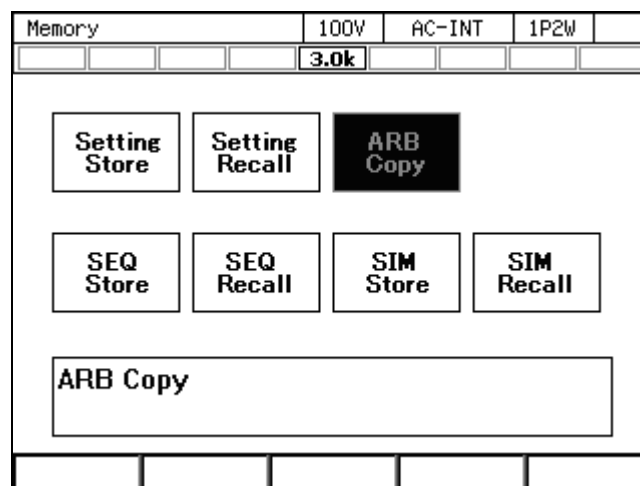

- In the [Direction] item, select [SYS→USB].

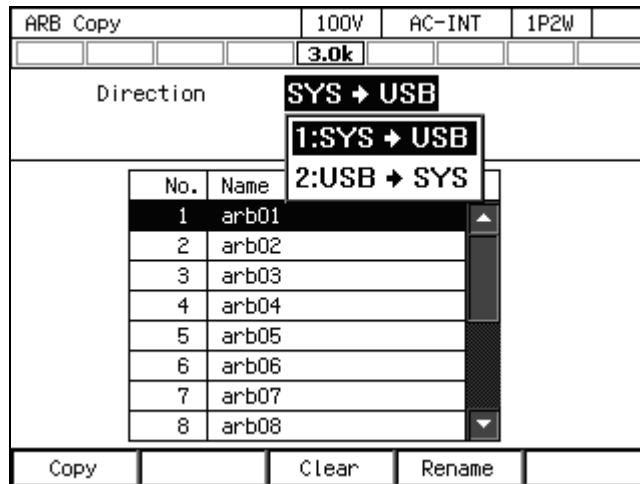

- From the data list box, select the arbitrary waveform to copy.

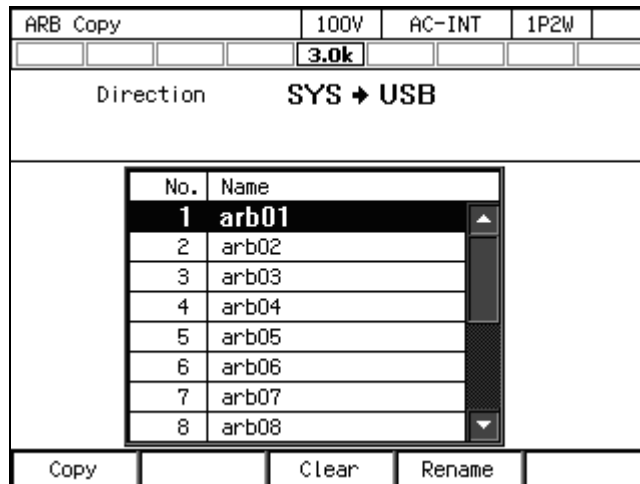

- Push the [Copy] soft-key. A window to confirm the save name opens. Enter the name. Select [OK] to copy. For how to enter a string, see 3.3.6.

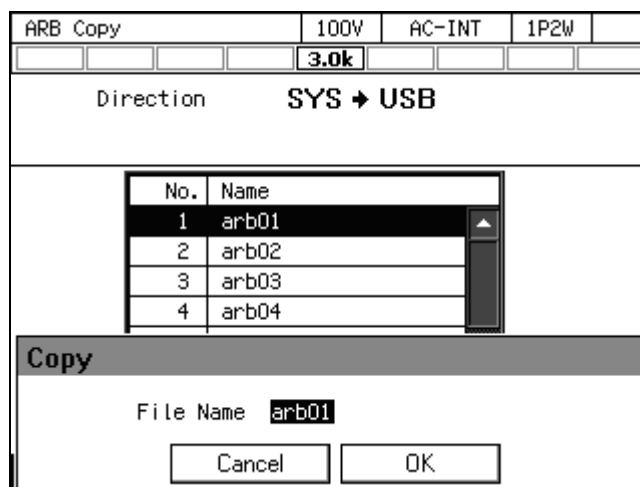

Notes

- When the data is copied to the USB memory, any existing file with the same name in the NF_TOOL\NF_KP\ARB_DATA folder is overwritten. No overwrite confirmation message is displayed.

■ Clearing, erasing, or renaming an Arbitrary Waveform Memory

- In the Memory View, select [ARB Copy].

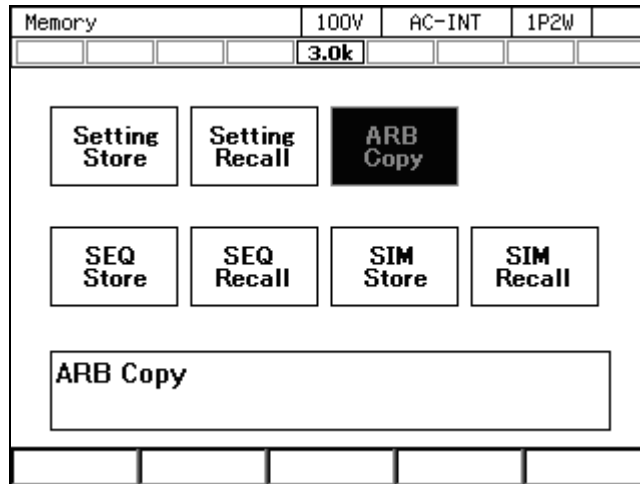

- In the [Direction] item, select the object to operate.
 SYS→USB: Selects the internal memory as the target of the operation.
 USB→SYS: Selects the USB memory as the target of the operation.

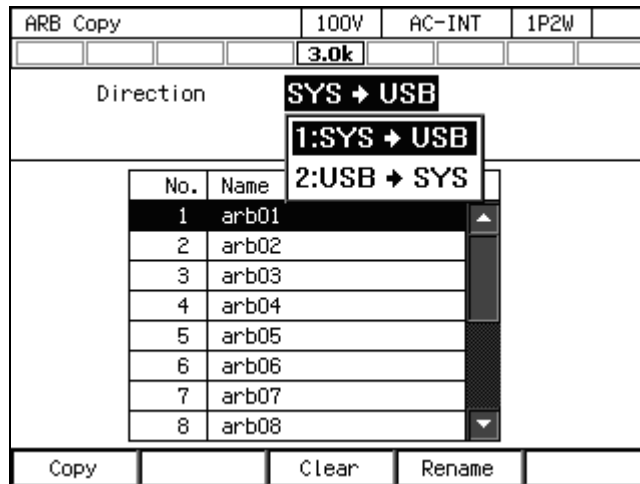

3. Select the data that is the target of the operation in the data list box.

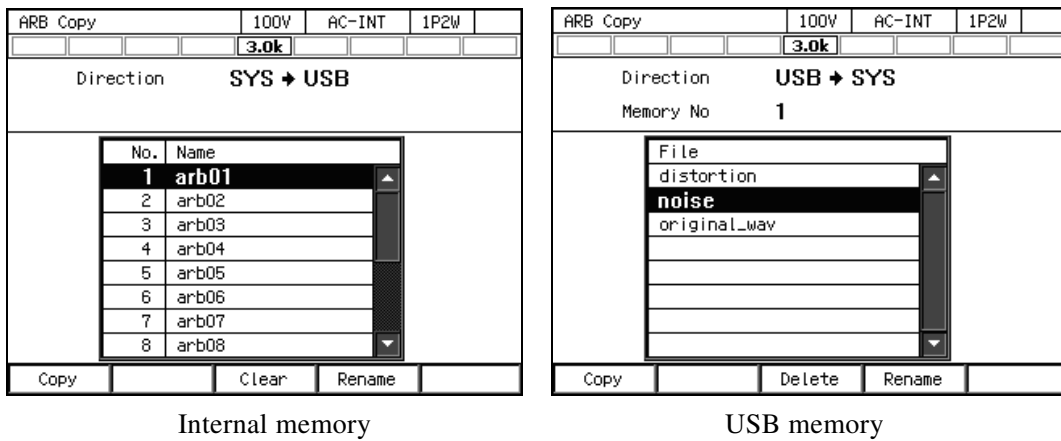

4. To clear/delete, push [Clear]/[Delete] soft-key. Confirmation message is displayed. Select [OK]. Clearing the internal Arbitrary Waveform Memory resets the data to triangle wave for memories from No. 1 to No. 8 and to square wave for memories from No. 9 to No. 16. Erasing an Arbitrary Waveform Memory in the USB memory deletes the applicable arbitrary waveform data file.

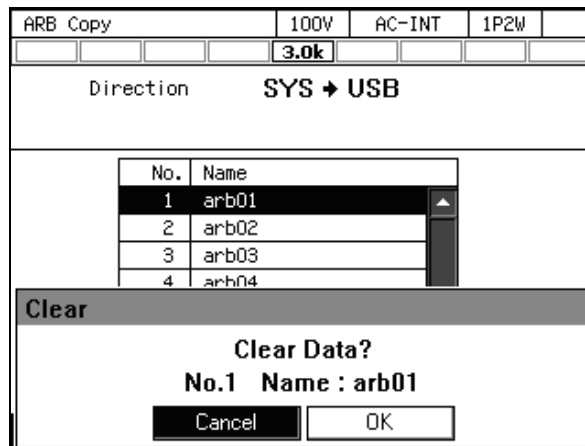

5. To rename, push [Rename] soft-key. Rename window opens. Enter a new name and then select [OK]. For how to enter a string, see 3.3.6.

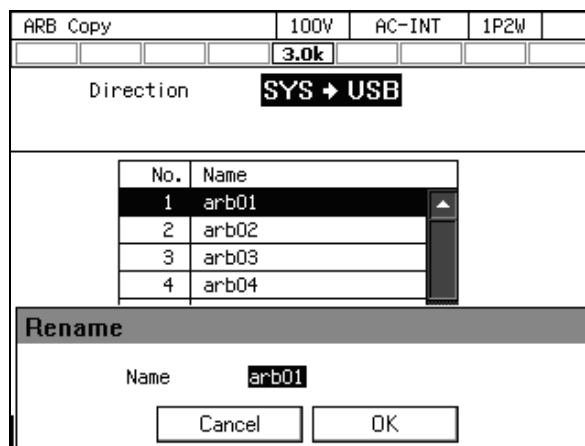

Notes

- A file cannot be renamed in the USB memory if a file with the same name exists in the NF_TOOLNF_KPARB_DATA folder. An error message is displayed.

4.8.3 Sequence Memory

The user-created sequence can be saved into the Sequence Memory.

Both the internal and USB memories can be selected as the Sequence Memory. Creation and saving of a sequence are performed using the sequence menu (see 4.2) or the control software (Optional).

For the content saved in the Sequence Memory, see Table 4-9.

The internal memory has 5 Sequence Memories from No. 1 to No. 5.

Table 4-9 Content Saved in Sequence Memory

Setting Item	Factory default setting
Output range selection	100 V
Output mode selection	AC-INT
Parameters of Sequence Function	Refer to 4.28

■ SEQ Store

In the Memory View, select [SEQ Store] to change to the Sequence Save View as below, allowing you to save, clear, and rename the sequence. For the operation method, see 4.2.8 and 4.2.9.

Sequence Store		100V	AC-INT	1P2W
		3.0k		
To	System			
Memory No.	1			
No.	Name			
1	seq01			
2	seq02			
3	seq03			
4	seq04			
5	seq05			
Store		Clear	Rename	

■ SEQ Recall

In the Memory View, select [SEQ Recall] to change to the Sequence Recall View as below, allowing you to load the sequence. For the operation method, see 4.2.6.

Sequence Recall		100V	AC-INT	1P2W
		3.0k		
From		System		
Memory No.		1		
No.	Name			
1	seq01			
2	seq02			
3	seq03			
4	seq04			
5	seq05			
Recall				

4.8.4 Simulation Memory

The user-created simulation can be saved in the Simulation Memory.

Both the internal and USB memories can be selected as the Simulation Memory. Creation and saving of a simulation are performed using the simulation menu (see 4.3) or the control software (Optional). For the content saved in the Simulation Memory, see Table 4-10.

The internal memory has 5 Simulation Memories from No. 1 to No. 5.

Table 4-10 Content Saved in Simulation Memory

Setting Item	Factory default setting
Output range selection	100 V
Simulation Function Parameters	Refer to 4.28

■ SIM Store

In the Memory View, select [SIM Store] to change to the Simulation Save View as below, allowing you to save, clear, and rename the simulation. For the operation method, see 4.3.8 and 4.3.9.

Simulation Store		100V	AC-INT	1P2W
		3.0k		
To		System		
Memory No.		1		
No.	Name			
1	sim01			
2	sim02			
3	sim03			
4	sim04			
5	sim05			
Store		Clear	Rename	

■ SIM Recall

In the Memory View, select [SIM Recall] to change to the Simulation Recall View as below, allowing you to load the simulation. For the operation method, see 4.3.6.

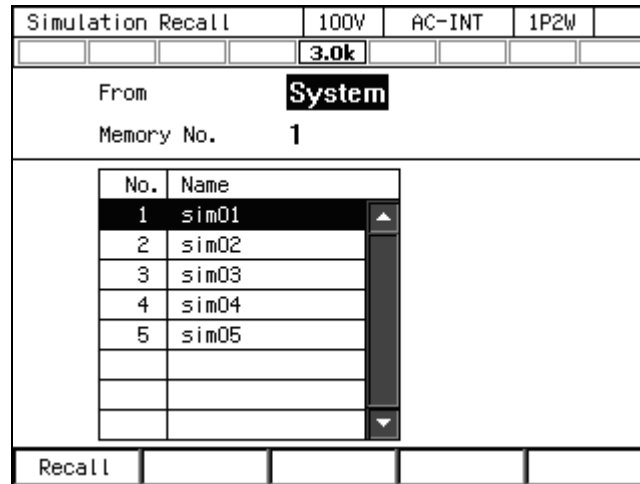

4.9 Using USB Memory Function

This product supports the mass storage class USB memory. The arbitrary waveform data, sequence data, simulation data, and Basic Setting Memory can be saved into and loaded from the USB memory.

When you connect a USB memory to this product, a window opens with the confirmation message "USB Memory Connected," then closes after a while.

The root folder of the USB memory should have folders as shown in Figure 4–23. Otherwise, these folders are created automatically when the USB memory is connected to this product.

To remove the USB memory connected to this product, the eject operation is necessary as explained in this section.

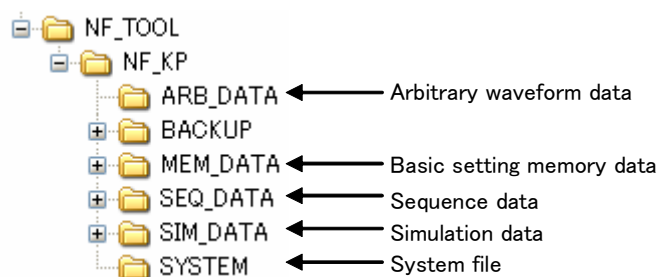

Figure 4-23 USB Memory Folder Structure



⚠ CAUTION

- Do not connect anything other than a USB memory to the front USB memory connector.
- Before removing the USB memory from this product, always perform the eject operation (see the next section). Removing the USB memory while it is being accessed may damage the data.
- Do not turn off this product while it is accessing the data in the USB memory.

Notes

- We do not guarantee that all USB memories can be operational with this product.
 - Use a FAT32-formatted USB memory. This product does not support the exFAT format which began to be supported from Windows Vista SP1.
 - This product does not have the USB memory formatting function.
 - The file name should consist of one byte alphanumeric characters. A file name that contains any double-byte character cannot be recognized correctly.
 - This product does not have the time information management function. Therefore, when the save operation is performed for the USB memory, its time stamp is updated to "2008/1/1 00:00:00."
 - Loading by the external control input is not available.
 - Limit the number of files to save in one USB memory up to 500 for each of the basic setting, arbitrary waveform, sequence, and simulation data. If the number of files exceeds this limit, this product cannot recognize the data files in the USB memory.
 - The BACKUP and SYSTEM folders in Figure 4–23 are not used by the users. Do not delete these folders and files in them, as they are used for firmware updating of this product and other purposes.
-

■ Removing the USB memory from this product (eject operation)

1. Perform the eject operation. Following two methods are available.
 - (a) Shortcut operation:  + 
 - (b) Press the MENU key to move to the root menu, then select [System]. In the System menu that opens, put the cursor on [Exec] next to the [USB Eject] item, then press the ENTER key.
2. The window opens with the confirmation message "USB Memory Disconnected." The window closes after a while.
3. Remove the USB memory.

Notes

- The eject operation cannot be performed in the following cases:
 - When the Memory View is open
 - When the data list box shows the files in the USB memory
-

4.10 Using Monitor Function

The output voltage and current waveform can be monitored using an oscilloscope connected to the monitor terminal on the rear. For the monitor output specifications, see 10.29.

■ Switching the monitor output

1. Press the MENU key to move to the root menu, then select [System].

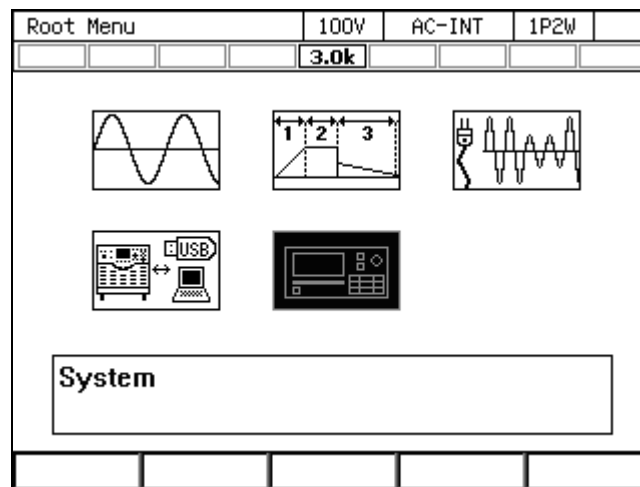

2. Put the cursor on [Setup] of the [Monitor] item, then press the ENTER key.

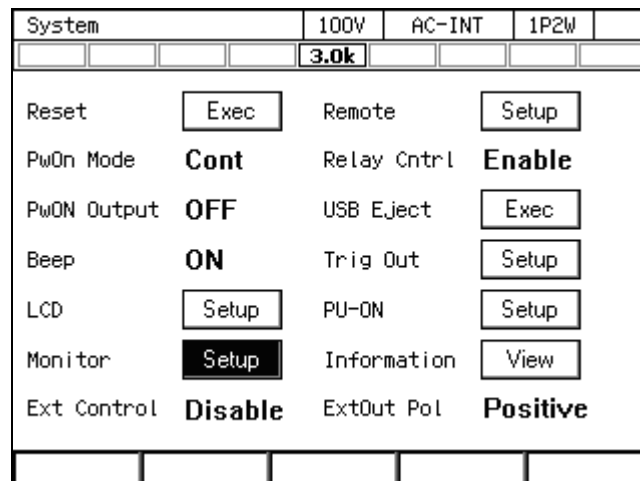

3. «Only for polyphase system» For the [Phs] item, select the desired phase.

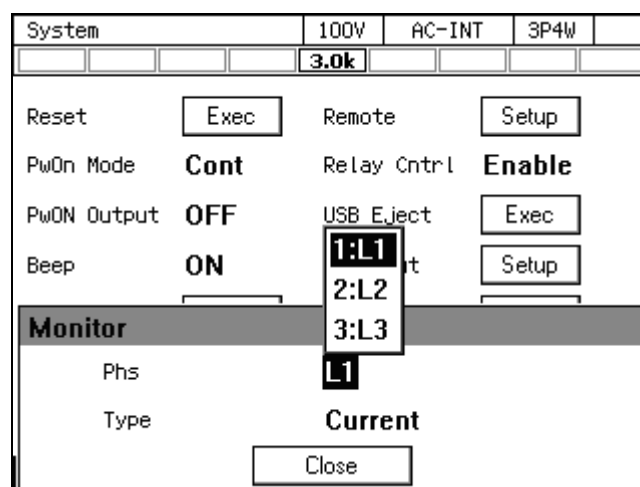

4. For the [Type] item, select the output voltage or current.

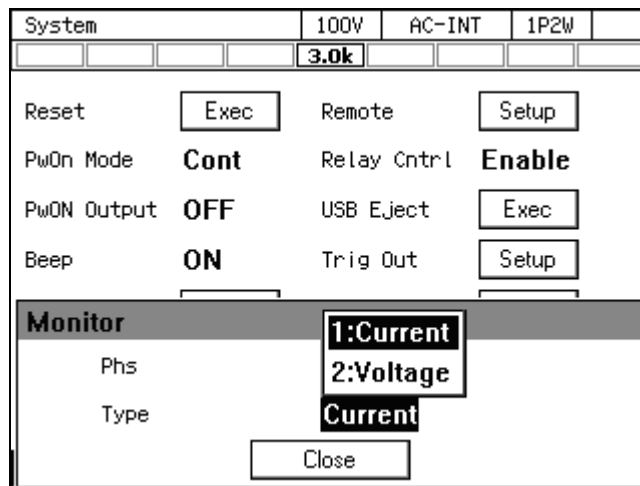

5. Put the cursor on [Close], then press the ENTER key.

- Notes -----
- In a polyphase system, configure monitor setting for each of the phases using the L1 phase cabinet. Each cabinet's monitor output connector outputs the monitor voltage of that phase.
 - The output voltage monitor watches the voltage at the output terminal whether the remote sensing state is on or off.
-

4.11 Using Remote Sensing Function

The Remote sensing function detects the output voltage at the sensing input terminal. When the Remote sensing function is on, the measured value of voltage is the voltage at the sensing input terminal, and the item symbol is displayed as "SV" on the panel display. The measured values of power (P, S, Q) and power factor (PF) are also the values that are calculated using the measured voltage value at the sensing input terminal. However, their item symbols on the panel display are not changed.

When the Remote sensing function is on, the output voltage at the sensing input terminal is calibrated by the AGC or Autocal function. Thus, by combining the Remote sensing function with the AGC/Autocal function, you can compensate the voltage drop due to wiring to the load.

The Remote sensing function can be set to on in the AC-INT, AC-VCA, AC-SYNC, DC-INT, and DC-VCA modes. However, for the AC mode, it can be set to on only when the waveform is a sine wave. When the Remote sensing function is on, the waveform cannot be changed to other than a sine wave. When the mode is changed to ACDC mode, when the signal source is changed to EXT or ADD, or when the Sequence or Simulation function is selected, the Remote sensing function is forcibly set to off.

Notes

- The on/off state of the Remote sensing function is kept even if the output range is changed.
- When the Remote sensing function is forcibly set to off, the settings saved in the System Setting Memory are not updated.

■ Cable connection for remote sensing

WARNING

- Before connecting the cable, turn off this product including its peripherals.

CAUTION

- Pay attention to the withstand voltage of the cable to be connected.
- Do not connect anything to the terminals that are not used.
- Do not input a signal having a different electric potential from the output terminal (for example, the signal at the secondary side of transformer) into the sensing input terminal.

Connect the sensing input terminal to the output voltage detecting end (for example, load end) using a cable.

■ Turning on/off Remote sensing function

1. Press the [Measure] soft-key, then select [2: Measure].

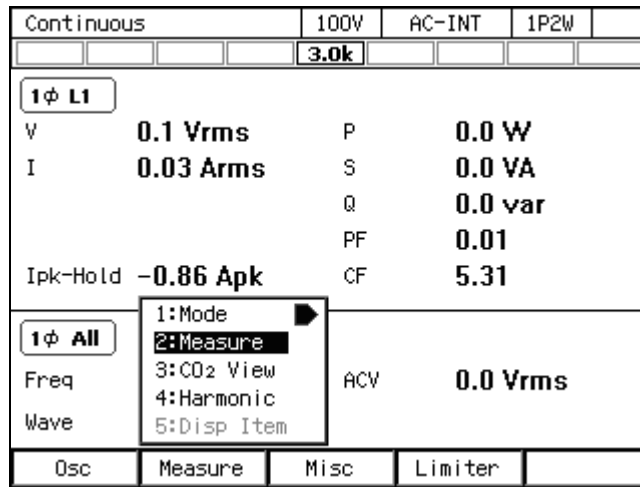

2. Use the [Rmt Sense] item to turn on or off, if necessary.

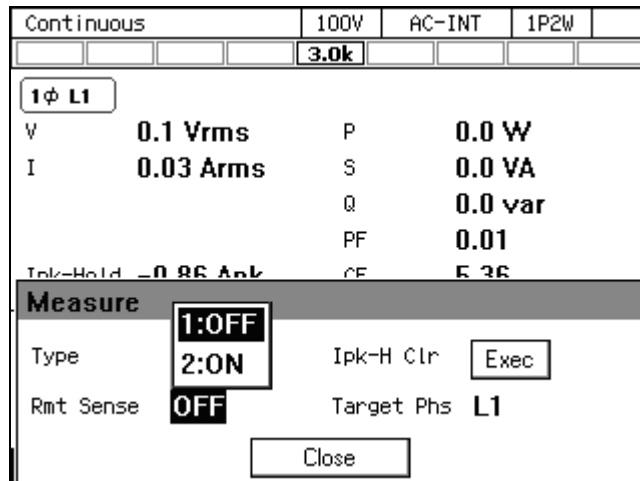

3. When the Remote sensing function is turned on, the item symbol of the output voltage measured value is changed to "SV".

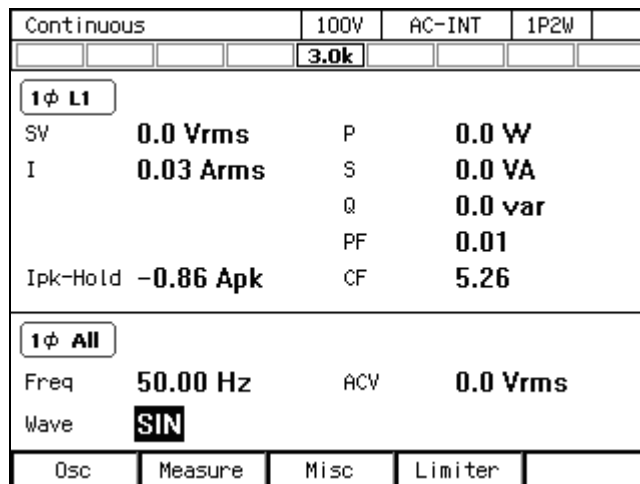

Notes

- The Remote sensing function can be turned on/off also in the AGC/Autocal set window.

4.12 Using AGC Function



The AGC (Automatic Gain Control) function calculates the ratio (calibration factor) of the output voltage measured value (effective value) versus the output voltage setting value automatically and continuously while this function is on, and multiplies the gain of the output amplifier by the calculated value, intending to match the output voltage with the setting value. With this function, the output voltage fluctuation can be suppressed even when the load is fluctuated. When the AGC function is set to on, the icon  is displayed.

As the detected part of the output voltage calibrated by the AGC function, either the sensing input terminal (the Remote sensing function is on) or the output terminal (the Remote sensing function is off) can be selected. By combining the Remote sensing function with the AGC function, you can compensate the voltage drop due to wiring to the load.

The AGC function can be set to on in the AC-INT, AC-VCA, AC-SYNC, DC-INT, and DC-VCA modes. However, for the AC mode, it can be set to on only when the waveform is a sine wave. When the AGC function is on, the waveform cannot be changed to other than a sine wave. When the mode is changed to ACDC mode, when the signal source is changed to EXT or ADD, or when the Sequence or Simulation function is selected, the AGC function is forcibly set to off. When the Autocal function is on, the AGC function cannot be used.

For the specification of the AGC function, see *10.16*.

Notes

- If the output voltage setting is out of the "Operation range" shown in *10.16*, the calibration is not performed while the AGC function setting remains on and the icon  is still displayed.
- If the difference is out of the "Calibration range" shown in *10.16*, the AGC function is forcibly set to off, and the icon  disappears.
- If the limiter operates while the AGC function is on, the AGC calibration is not performed. When the limiter operation is completed, the AGC calibration restarts. If the protection function is activated, the output is turned off, but the AGC setting remains on.
- The on/off setting of the AGC function is kept even if the output range is changed.
- When the AGC function is forcibly set to off, the settings saved in the System Setting Memory are not updated.
- The AGC function updates the calibration factor continuously while the AGC function is on. In contrast, the Autocal function continues to use the calibration factor obtained when Autocal is turned on until Autocal is turned off. Therefore, in the AGC function, the output voltage is calibrated properly even when the load is fluctuated, but there is the response time to reflect the update of the calibration factor. Meanwhile, in the Autocal function, the output voltage may not be calibrated properly when the load is fluctuated, but once Autocal is turned on, there is no response time needed for calibration.

■ Turning on the AGC function

1. Turn on the output.
2. Open the AGC/Autocal set window. Following two methods are available.
 - (a) Shortcut operation: **SHIFT** + **5**
 - (b) Push the [Misc] soft-key and select [1: AGC/Auto Cal].

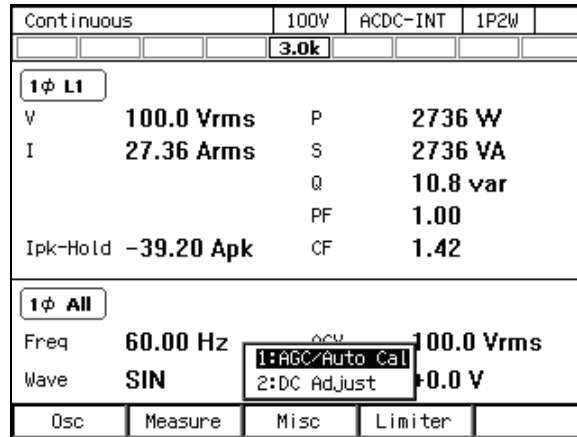

3. Use the [Rmt Sense] item to set the Remote sensing function to on or off, if necessary.

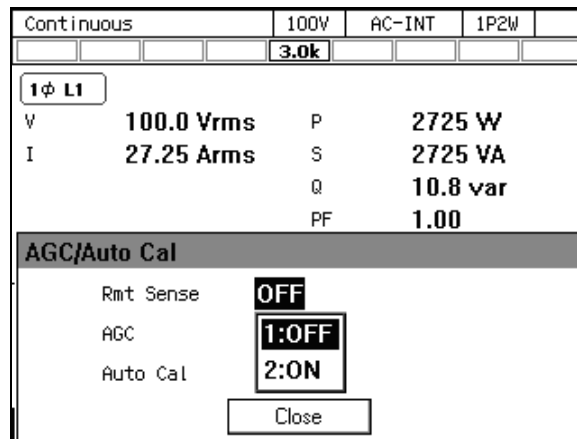

4. In the [AGC] item, select [2: ON]. If the output voltage setting is within the AGC operation range, the AGC calibration is started when [ON] is selected here.

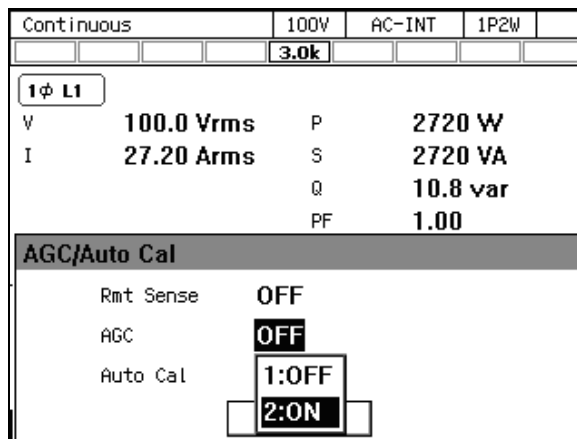

5. Close the window.

■ Turning off the AGC function

1. Open the AGC/Autocal set window. Following two methods are available.

(a) Shortcut operation: **SHIFT** + **5**

(b) Push the [Misc] soft-key and select [1: AGC/Auto Cal].

Continuous		100V	AC-INT	1P2W
AGC		3.0k		
1φ L1				
V	100.0 Vrms	P	2723 W	
I	27.23 Arms	S	2723 VA	
		Q	10.7 var	
		PF	1.00	
Ipk-Hold	-39.66 Apk	CF	1.42	
1φ All				
Freq	60.00 Hz	ACV	100.0 Vrms	
Wave	SIN	1:AGC/Auto Cal		
		2:DC Adjust		
Osc	Measure	Misc	Limiter	

2. In the [AGC] item, select [1: OFF]. When [OFF] is selected here, the AGC calibration finishes.

Continuous		100V	AC-INT	1P2W
AGC		3.0k		
1φ L1				
V	100.0 Vrms	P	2720 W	
I	27.20 Arms	S	2720 VA	
		Q	10.7 var	
		PF	1.00	
AGC/Auto Cal				
Rmt Sense	OFF			
AGC	ON			
Auto Cal	1:OFF			
	2:ON			

3. Use the [Rmt Sense] item to set the Remote sensing function to on or off, if necessary.

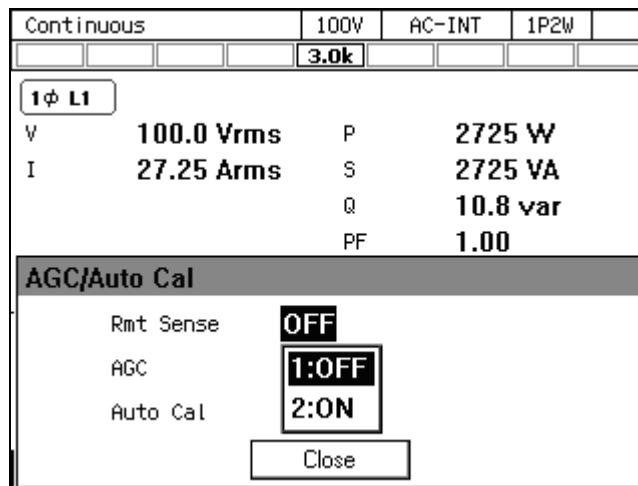

4. Close the window.

4.13 Using Autocal Function

The Autocal (Automatic Calibration) function calculates the ratio (calibration factor) of the output voltage measured value (effective value) versus the output voltage setting value when this function is turned on, and multiplies the gain of the output amplifier by the calculated value, intending to match the output voltage with the setting value. The calculated calibration factor is used as a fixed value until the Autocal function is turned off. Therefore, even when the Autocal function is on, the output voltage fluctuation may occur if the load is fluctuated. When the Autocal function is set to on, the icon **ACAL** is displayed.

As the detected part of the output voltage calibrated by the Autocal function, either the sensing input terminal (the Remote sensing function is on) or the output terminal (the Remote sensing function is off) can be selected. Combining the Remote sensing function with the Autocal function, you can compensate the voltage drop due to wiring to the load.

The Autocal function can be set to on in the AC-INT, AC-VCA, AC-SYNC, DC-INT, and DC-VCA modes. However, for the AC mode, it can be set to on only when the waveform is a sine wave. When the Autocal function is on, the waveform cannot be changed to other than a sine wave. When the mode is changed to ACDC mode, when the signal source is changed to EXT or ADD, or when the Sequence or Simulation function is selected, the Autocal function is forcibly set to off. When the AGC function is on, the Autocal function cannot be used.

For the specification of the Autocal function, see 10.17.

Notes

- When the Autocal function is on, the calibration factor is always used to perform the calibration as a multiplier.
- If the conditions for setting the [Acal] to [ON] shown in 10.17 are not satisfied, the Autocal function cannot be turned on. However, if any one of the conditions required for setting [Acal] to [ON] becomes disabled while the Autocal function is on, the ON setting of the Autocal function is retained.
- If the difference is out of the "Calibration range" shown in 10.17, the Autocal function is forcibly set to off
- If the limiter operates while the Autocal function is on, the Autocal calibration is still applied, but the limit is applied on the output. If the protection function is activated, the output is turned off, but the Autocal setting remains on.
- When the output range is changed, the Autocal function is forcibly set to off.
- When the Autocal function is forcibly set to off, the settings saved in the System Setting Memory are not updated.
- The Autocal function continues to use the calibration factor obtained when Autocal is turned on until Autocal is turned off. In contrast, the AGC function updates the calibration factor continuously while the AGC function is on. Therefore, in the Autocal function, the output voltage may not be calibrated properly when the load is fluctuated, but once Autocal is turned on, there is no response time needed for calibration. Meanwhile, in the AGC function, the output voltage is calibrated properly even when the load is fluctuated, but there is the response time to reflect the update of the calibration factor.

■ Turning on the Autocal function

1. Turn on the output.
2. Open the AGC/Autocal set window. Following two methods are available.
 - (a) Shortcut operation: **SHIFT** + **5**
 - (b) Push the [Misc] soft-key and select [1: AGC/Auto Cal].

Continuous	100V	AC-INT	1P2W
	3.0k		
1φ L1			
V	100.0 Vrms	P	2728 W
I	27.28 Arms	S	2728 VA
		Q	10.8 var
		PF	1.00
Ipk-Hold	-39.66 Apk	CF	1.42
1φ All			
Freq	60.00 Hz	AGC	100.0 Vrms
Wave	SIN	1:AGC/Auto Cal 2:DC Adjust	
Osc	Measure	Misc	Limiter

- Use the [Rmt Sense] item to set the Remote sensing function to on or off, if necessary.

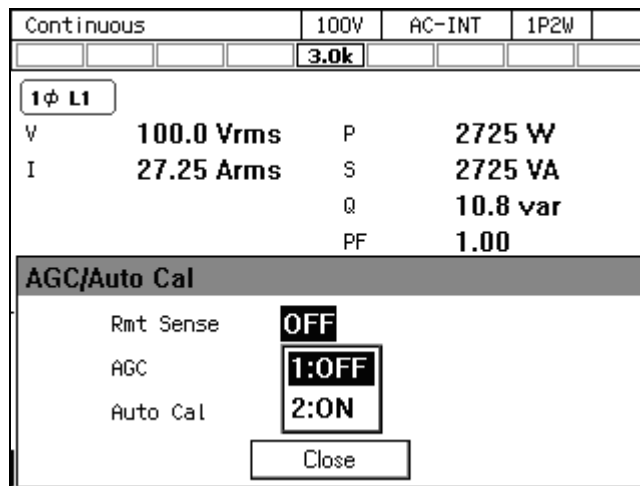

- Use the [Auto Cal] item to turn on or off the Autocal function. When [ON] is selected here, the calibration factor of the Autocal function is calculated, and the calibration is started.

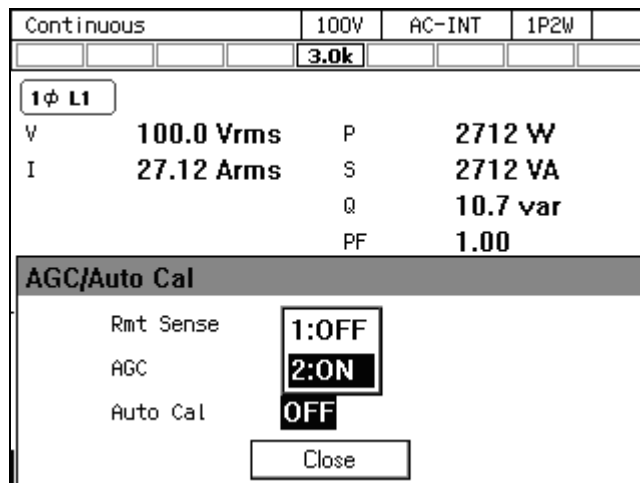

- Close the window.

■ Turning off the Autocal function

1. Open the Autocal set window. Following two methods are available.

(a) Shortcut operation: **SHIFT** + **5**

The window is toggled between the AGC setting window and the Autocal setting window every time you press the keys.

(b) Push the [Misc] soft-key and select [1: AGC/Auto Cal].

Continuous	100V	AC-INT	1P2W
ACAL	3.0k		
1φ L1			
V	100.0 Vrms	P	2723 W
I	27.23 Arms	S	2723 VA
		Q	10.7 var
		PF	1.00
Ipk-Hold	-39.66 Apk	CF	1.42
1φ All			
Freq	60.00 Hz	OCV	100.0 Vrms
Wave	SIN	1:AGC/Auto Cal 2:DC Adjust	
Osc	Measure	Misc	Limiter

2. In the [Auto Cal] item, select [1: OFF]. When [OFF] is selected here, the Autocal calibration finishes, and the calibration factor is cleared.

Continuous	100V	AC-INT	1P2W
ACAL	3.0k		
1φ L1			
V	100.0 Vrms	P	2708 W
I	27.09 Arms	S	2708 VA
		Q	10.7 var
		PF	1.00
AGC/Auto Cal			
Rmt Sense	1:OFF		
AGC	2:ON		
Auto Cal	ON		
	Close		

- Use the [Rmt Sense] item to set the Remote sensing function to on or off, if necessary.

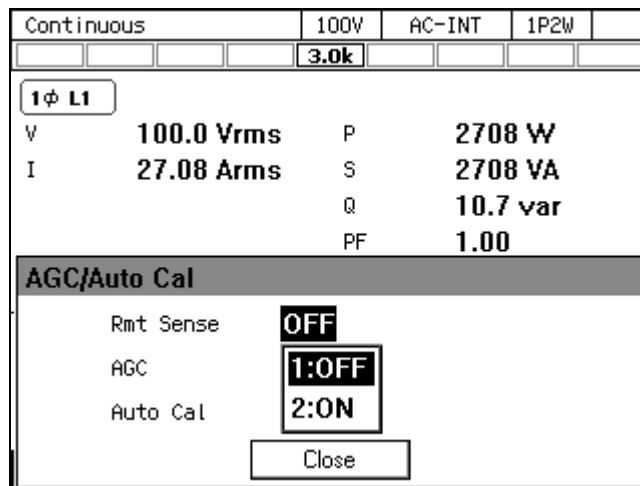

- Close the window.

4.14 Adjusting DC Offset

Even when the output voltage is set to 0 V, the DC offset voltage from several mV to several tens mV may exist in the output. The DC offset adjustment function can reduce such DC voltage close to zero.

For the DC offset adjustment, four types of values are retained for each output voltage range and AC/DC mode. For the polyphase system, the values need to be set for each phase. The setting range of the DC offset adjustment value is shown in Table 4-11.

Table 4-11 Setting Range of DC Offset Adjustment Value

AC/DC mode	Minimum value	Maximum value	Resolution	Initial value	Unit
AC	-50.0	+50.0	0.1	0.0	mV
ACDC, DC	-250	+250	1	0	mV

Note: The setting range is common to 100 V range and 200 V range.

■ Operation procedure

1. Press the [Misc] soft-key and select [2:DC Adjust]. The DC offset adjustment window opens.

Continuous		100V	AC-INT	1P2W
		3.0k		
1φ L1				
V	0.1 Vrms	P	0.0 W	
I	0.04 Arms	S	0.0 VA	
		Q	0.0 var	
		PF	0.02	
Ipk-Hold	-39.66 Apk	CF	4.40	
1φ All				
Freq	60.00 Hz	ACV	0.0 Vrms	
Wave	SIN	1:AGC/Auto Cal		
		2:DC Adjust		
Osc	Measure	Misc	Limiter	

2. «Only for the polyphase system» In the [Target Phs] item, specify the phase to perform the DC offset adjustment. In this example, the single-phase model is used, so this item is not specified (leave it as "L1").

Continuous		100V	AC-INT	3P4W
		3.0k		
3φ L1				
V	0.1 Vrms	P	0.0 W	
I	0.02 Arms	S	0.0 VA	
		Q	0.0 var	
		PF	0.00	
Ipk-Hold	-0.08 Apk	CF	3	
DC Adjust				
DC Adj	+0.0 mV	Target Phs	L1	
Close				

- While checking the DC offset of the output voltage, adjust the value in the [DC Adj] item so that the DC offset gets close to zero.

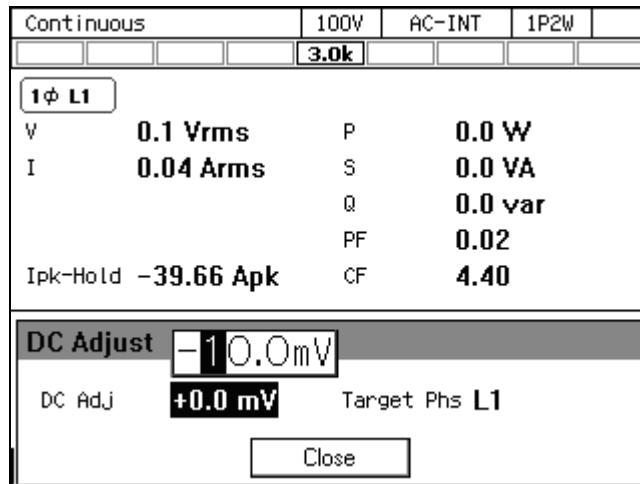

- Close the window.

4.15 Using for Unbalanced Polyphase Output

For the polyphase system, you can set the phase voltage and the phase to be unbalanced. The phase can be set to be unbalanced from 0.0 to 359.9 degrees for both L2 phase and L3 phase.

■ Operation procedure

- Press the [Osc] soft-key and select [6: Phase Mode]. The setting window for the phase mode opens.

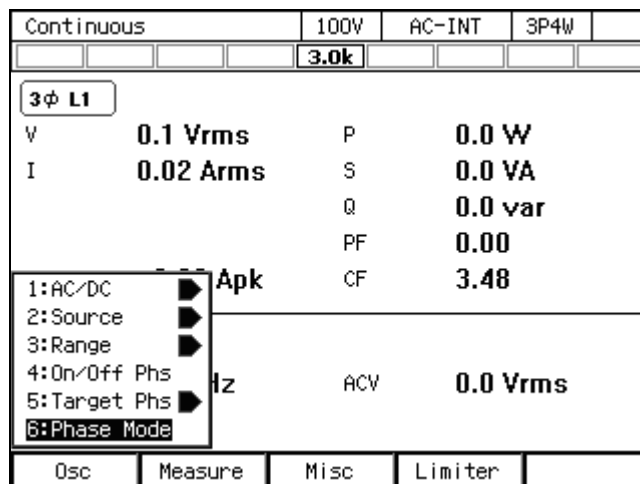

2. In the [Mode] item, select [1: Unbalance]. The mode is switched to the unbalanced mode.

Continuous	100V	AC-INT	3P4W
3.0k			
3ϕ L1			
V	0.1 Vrms	P	0.0 W
I	0.02 Arms	S	0.0 VA
		Q	0.0 var
		PF	0.00
Trk-Hold	0.08 Arms	CF	3.46
Phase Mode			
Mode	Balance		
L1-L2	1:Unbalance	L1-L3	240.0
	2:Balance		
		Close	

3. To unbalance the phase, set the phase in the [L1-L2] and [L1-L3] items. When the setting is completed, close the window.

Continuous	100V	AC-INT	3P4W
3.0k			
3ϕ L1			
V	0.1 Vrms	P	0.0 W
I	0.02 Arms	S	0.0 VA
		Q	0.0 var
		PF	0.00
Trk-Hold	0.08 Arms	CF	3.47
Phase Mode			
Mode	120.0		
L1-L2	120.0	L1-L3	240.0
		Close	

4. To unbalance the phase voltage, press the [Osc] soft-key and select [5: Target Phs], and then select the phase to set the phase voltage. Or perform the Shortcut operation (SHIFT) + (1) to switch the phase to set. Set the phase voltage in [ACV].

Continuous	100V	AC-INT	3P4W												
3.0k															
3ϕ L1															
V	0.1 Vrms	P	0.0 W												
I	0.02 Arms	S	0.0 VA												
		Q	0.0 var												
		PF	0.00												
			3.48												
			0.0 Vrms												
<table border="1"> <tr> <td>1:AC/DC</td> <td>2:L2</td> </tr> <tr> <td>2:Source</td> <td>3:L3</td> </tr> <tr> <td>3:Range</td> <td>4:All Phs</td> </tr> <tr> <td>4:On/Off Phs</td> <td>5:All Line</td> </tr> <tr> <td>5:Target Phs</td> <td></td> </tr> <tr> <td>6:Phase Mode</td> <td></td> </tr> </table>				1:AC/DC	2:L2	2:Source	3:L3	3:Range	4:All Phs	4:On/Off Phs	5:All Line	5:Target Phs		6:Phase Mode	
1:AC/DC	2:L2														
2:Source	3:L3														
3:Range	4:All Phs														
4:On/Off Phs	5:All Line														
5:Target Phs															
6:Phase Mode															
Osc	Measure	Misc	Limiter												

----- Notes -----

- When the unbalanced mode is switched to the balanced mode, the AC voltage of each phase becomes equal to the setting value of the L1 phase. The phase setting value is the value of the balanced mode (180 degrees for single-phase three-wire output, and 120 degrees and 240 degrees for three-phase output).
- Switching between the unbalanced mode and balanced mode is possible even in the output on state.
- Depending on combined condition of the phase angle setting and load, an error message (ID: 53 Power Unit DCPS Overvoltage) may be displayed and the output may be turned off.

4.16 Using as DC Power Supply

You can use this product as a DC power supply by switching the AC/DC mode to the DC mode or the ACDC mode. For the voltage setting range, see 10.6.

----- Notes -----

- The polyphase system cannot be used as a DC power supply. The DC mode cannot be used. The DC voltage (DCV) of the ACDC mode also cannot be set.
- The signal sources that can be combined with the ACDC mode are INT, SYNC, EXT, and ADD.
- The signal sources that can be combined with the DC mode are INT and VCA.

■ Operation Method

1. Enter the ACDC mode or the DC mode. Following two methods are available.
 - (a) Shortcut operation: **SHIFT** + **7**
 Every time you press the keys, the mode is switched to AC, ACDC, and DC in this order.
 - (b) Press the [Osc] soft-key and select [1:AC/DC]. From the opened menu, select [2: ACDC] or [3: DC].

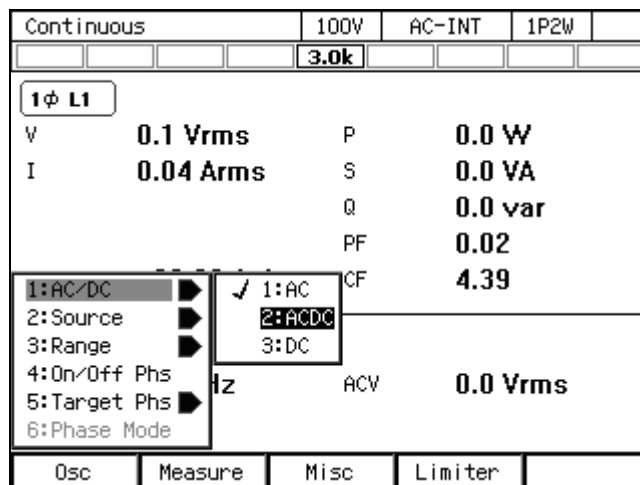

2. Set the output DC voltage in the [DCV] item.

Continuous		100V	ACDC-INT	1P2W
		3.0k		
1φ L1				
V	0.1 Vrms	P	0.0 W	
I	0.04 Arms	S	0.0 VA	
		Q	0.0 var	
		PF	0.02	
Ipk-Hold	-39.66 Apk	CF	4.51	
1φ All				
Freq	60.00 Hz	ACV	0.0 Vrms	
Wave	SIN	DCV	+0.0 V	
Osc	Measure	Misc	Limit	

4.17 Setting Voltage using External DC Input Signal

In the AC-VCA mode, you can use the external DC input signal to set the AC output voltage of the internal signal source. In the DC-VCA mode, you can use the external DC input signal to set the DC output voltage of the internal signal source. The external DC signal is input to this product through the external signal input connector. When the signal source is VCA, the specifications except the output voltage setting are same as when the signal source is INT.

Notes

- For VCA, the external signal input is detected with the interval of about 100 ms.

4.17.1 Using External Signal in AC-VCA Mode

In the AC-VCA mode, the peak value of the output AC voltage (ACV) is set according to the following figure, by using the gain setting value and the voltage of the external DC signal.

$$\text{ACV (Vpk)} = \text{Gain} \times \text{External DC signal voltage (V)}$$

For the specifications of the gain setting range and the external DC signal input voltage range, see 10.22.2.

Notes

- The gain setting value is retained for each of 100 V/200 V ranges and for each of AC/DC modes.
- Within the same range and the same mode, the same value is retained for the gain setting value, regardless of the combination of the signal sources (VCA, EXT, ADD).
- For the polyphase system, the ACV setting using VCA is common to all phases.
- When the switching from AC-VCA mode to ACDC mode, the signal source is forcibly set to INT.

■ Examples

1. When the waveform is SIN, the gain is 100, and the external DC signal voltage is 1 V, the output will be a sine wave of which amplitude is 100 Vpk (= 70.7 Vrms).
2. When the waveform is SIN, the gain is 100, and the external DC signal voltage is 1.41 V, the output will be a sine wave of which amplitude is 141 Vpk (= 100 Vrms).

■ Operation procedure

1. Turn off the output, and enter the AC mode. Following two methods are available.
 - (a) Shortcut operation: **SHIFT** + **7**
 Every time you press the keys, the mode is switched to AC, ACDC, and DC in this order.
 - (b) Press the [Osc] soft-key and select [1:AC/DC]. From the opened menu, select [1: AC].

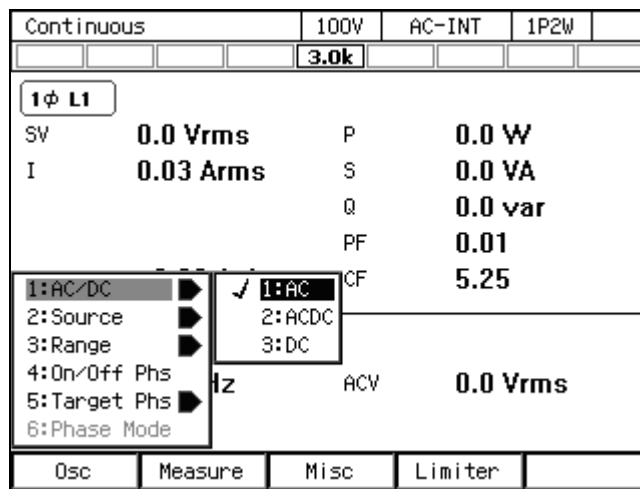

2. Press the [Osc] soft-key and select [2:Source]. From the opened menu, select [2: VCA].

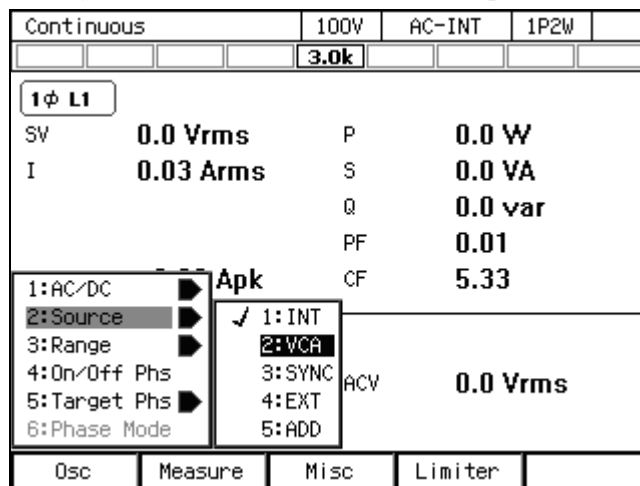

3. Set the [Freq], [Wave], and [Gain] items.

Continuous		100V	AC-VCA	1P2W
		3.0k		
1φ L1				
SV	0.0 Vrms	P	0.0 W	
I	0.03 Arms	S	0.0 VA	
		Q	0.0 var	
		PF	0.01	
Ipk-Hold	-0.86 Apk	CF	5.27	
1φ All			Gain	100.0
Freq	50.00 Hz			100.0
Wave	SIN			
Osc	Measure	Misc	Limiter	

4. Supply a DC voltage to the external signal input connector.
5. Turn on the output.

4.17.2 Using External Signal in DC-VCA Mode

In the DC-VCA mode, the setting value of the output DC voltage (DCV) is set according to the following figure, by using the gain setting value and the voltage of the external DC signal.

$$\text{DCV (V)} = \text{Gain} \times \text{External DC signal voltage (V)}$$

For the specifications of the gain setting range and the external DC signal input voltage range, see 10.22.2.

----- Notes -----

- The gain setting value is retained for each of 100 V/200 V ranges and for each of AC/DC modes.
- Within the same range, the same value is retained for the gain setting value, regardless of the combination of the signal sources (VCA, EXT, ADD).
- When the switching from DC-VCA mode to ACDC mode, the signal source is forcibly set to INT.

■ Examples

When the gain is 100, and the external DC signal voltage is 1 V, the output will be a DC voltage of 100 V.

■ Operation procedure

1. Turn off the output, and enter the DC mode. Following two methods are available.

(a) Shortcut operation: **SHIFT** + **7**

Every time you press the keys, the mode is switched to AC, ACDC, and DC in this order.

(b) Press the [Osc] soft-key and select [1:AC/DC]. From the opened menu, select [3: DC].

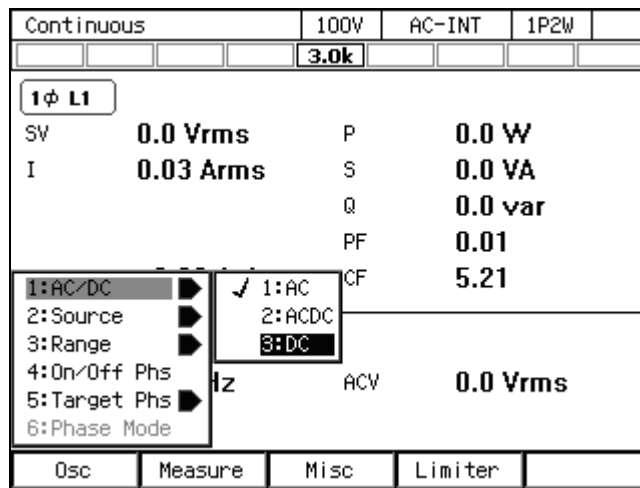

2. Press the [Osc] soft-key and select [2:Source]. From the opened menu, select [2: VCA].

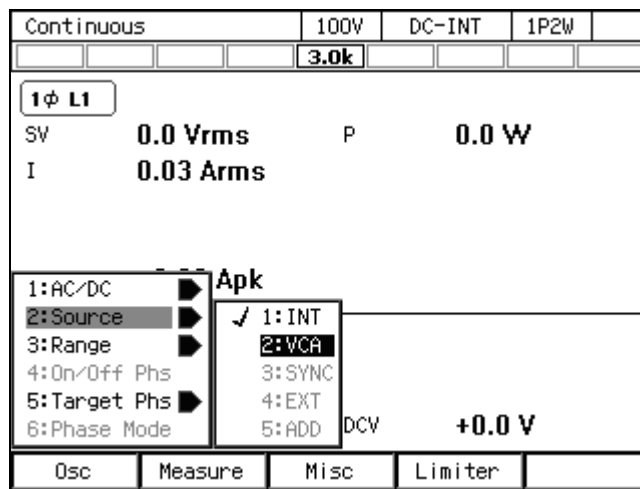

- Set the [Gain] item.

Continuous	100V	DC-VCA	1P2W	
				3.0k
1φ L1				
SV	0.0 Vrms	P	0.0 W	
I	0.03 Arms			
Ipk-Hold -0.86 Apk				
1φ All				
		Gain	100.0	
			100.0	
Osc	Measure	Misc	Limiter	

- Supply a DC voltage to the external signal input connector.
- Turn on the output.



4.18 Control Using External Control Function

You can control the output on/off and the starting/stopping of Sequence by inputting the logic signal or the non voltage contact signal. You can also get the product state by using the logic signal. The polarity of state output can be switched. The connector to be used is DBLC-J25SAF-10L9E (D-sub, 25-pin, M2.6 mm screw) manufactured by JAE. For the specification of I/O signals, see [10.26](#), and for the pin assignment of the CONTROL I/O connector, see [Table 4-12](#).

----- Notes -----

- You can enable/disable the external control function. When the external control function is disabled, the input from the external control is not accepted, but the state output signal is output.
- We recommend that when the external control function is not used, the function is set to disabled to avoid malfunctioning due to any exogenous noise.
- The external control input signal is ignored when the product is remote controlled via the communication interface.
- The memory 1 and 2 inputs are the inputs for specifying the memory number. For No. 1 to No. 4 memory, specify the 2 bit memory number of the Basic Setting Memory in the Continuous function, or of the Sequence Memory in the Sequence function, or of the Simulation Memory in the Simulation function.
- When the memory recall input is changed from high to low, this loads the data of the Basic Setting Memory in the Continuous function, or of the Sequence Memory in the Sequence function, or of the Simulation Memory in the Simulation function which has the number specified by the memory 1 and 2 inputs. For the Sequence and Simulation function, the compile is also performed.

Table 4-12 CONTROL I/O Pin Assignment

pin	I/O	Function	Remarks
1	Output	Power On/Off	Low: Off, High: On
2	Output	Output On/Off*	Low: On, High: Off (Negative) Low: Off, High: On (Positive)
3	Output	Protection operation*	Low: Active, High: None (Negative) Low: None, High: Active (Positive)
4	Output	Limiter operation*	Low: Active, High: None (Negative) Low: None, High: Active (Positive)
5	Output	AGC/Autocal setting state*	Low: On, High: Off (Negative) Low: Off, High: On (Positive)
6	Output	Software busy*	Low: Busy, High: Ready (Negative) Low: Ready, High: Busy (Positive)
7	Output	Output range	Low: 200 V, High: 100 V
8	Output	—	Unused
9	Output	Step sync code 1 (bit 0)	High level or Low level (see Table 4-13)
10	Output	Step sync code 2 (bit 1)	
11	Output	Trigger	Positive  or Negative 
12	Output	—	Unused
13	Input	Output Off	Falling Off
14	Input	Output On	Falling On
15	Input	Sequence start/resume	Falling Start
16	Input	Stop of sequence	Falling Stop
17	Input	Sequence is in the Hold status	Falling Hold
18	Input	Sequence branch 1	Falling Branch start
19	Input	Sequence branch 2	Falling Branch start
20	Input	Memory recall (+ compile)	Falling Recall
21	Input	Memory specification 1	Specify 0 to 3 (See Table 4-14, equivalent to memory 1 to 4, respectively)
22	Input	Memory specification 2	
23	Input	Clear the current peak-hold value	Falling Clear
24	—	GND	—
25	Reserved	Do not connect anything	Do not connect anything

Note 1: The polarity of state output marked with asterisk (*) can be switched.

Note 2: At 25th pin, +5 V is output for test in manufacturing, and the pin is not assumed to be used by user. Do not connect this pin to anything, or the product might become unstable.

Table 4-13 Step sync code

bit	Step sync code			
	LL	LH	HL	HH
0	Low	High	Low	High
1	Low	Low	High	High

Table 4-14 Memory specification

	Memory No.			
	1	2	3	4
Specify	0	1	2	3
Memory specification 1	Low	High	Low	High
Memory specification 2	Low	Low	High	High

■ Enabling/disabling external control function

1. Press the MENU key to move to the root menu, then select [System]. The system setting window opens.

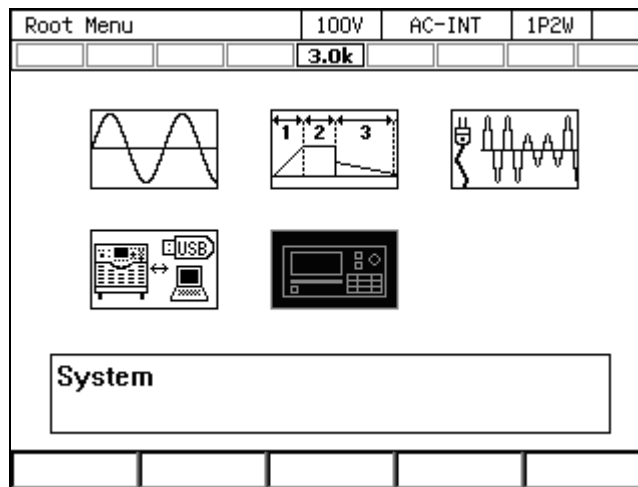

- In the [Ext Control] item, select [1: Disable] or [2: Enable].

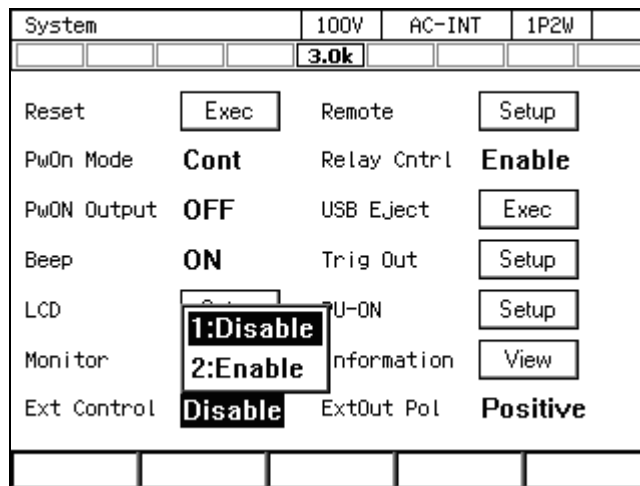

■ Setting the polarity of the state output

- Press the MENU key to move to the root menu, then select [System]. The system setting window opens.

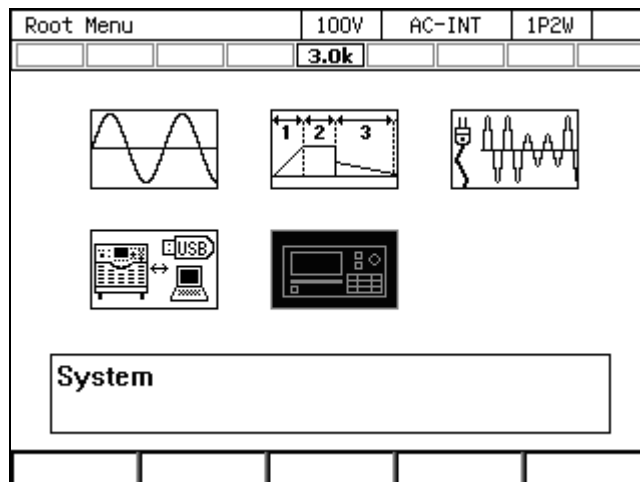

- In the [ExtOut Pol] item, select [1: Negative] or [2: Positive].

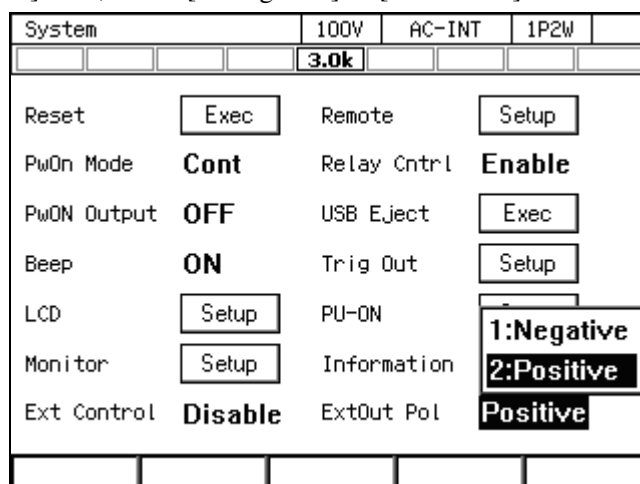

■ Setting the trigger output

1. Press the MENU key to move to the root menu, then select [System]. The system setting window opens.

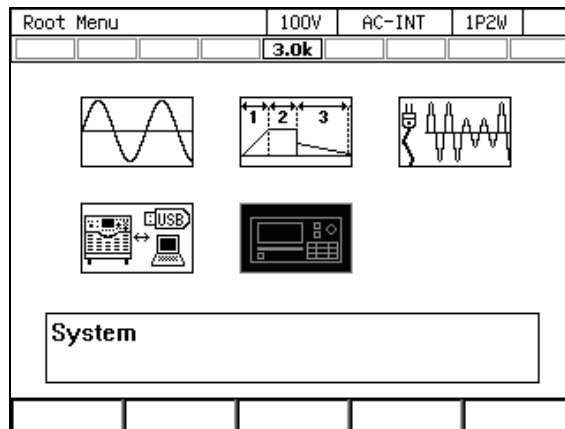

2. Move the cursor to [Setup] next to the [Trig Out] item, and select it. The trigger output setting window opens.

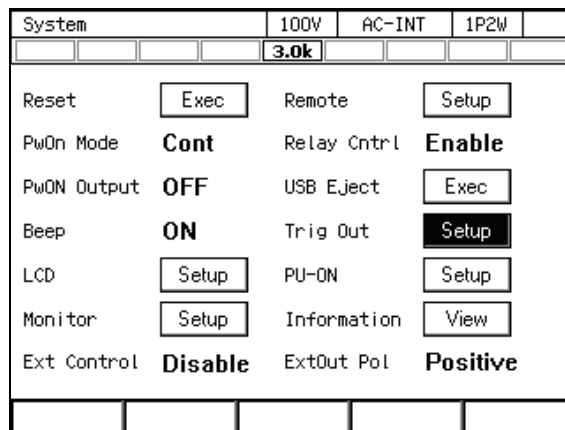

3. Set the polarity (Positive/Negative) in the [Polarity] item, and set the pulse width in the [Width] item.

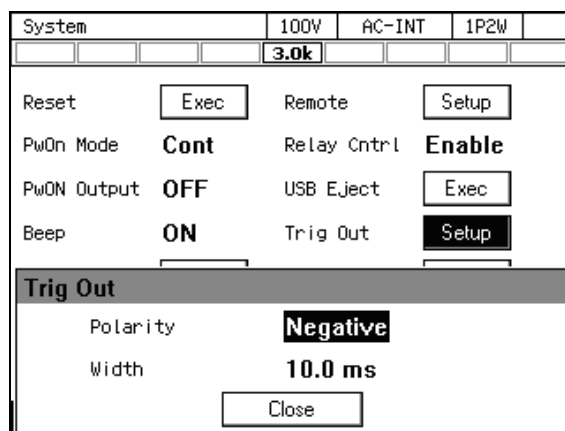

4. Move the cursor to [OK], then press the ENTER key. The trigger output setting window is closed.

4.19 Synchronizing the Output Frequency with the Power Line or the External Signal

When you select SYNC for the signal source, you can synchronize the frequency of the internal signal source with the power line or the external signal. The icon **LOCK** is displayed when the internal signal source is synchronized with the external signal. The icon **UNLOCK** is displayed when the synchronization is not performed. The measured synchronization frequency value is displayed in the measured value area on the screen. See 10.11 for the measurement specification of the synchronization frequency and 10.22.1 for the interface specification of the external synchronization signal.

Notes

- The output on phase/off phase setting (3.4.7) is valid in SYNC also.
- You cannot make the output on if synchronization is not performed.
- When the switching from AC-SYNC or ACDC-SYNC mode to DC mode, the signal source is forcibly set to INT.

■ Operation procedure

1. If you want to synchronize the internal signal source with the external signal, input the synchronization signal by using the external signal input connector. If you want to synchronize it with the power line, this step is not necessary.
2. Press the [Osc] soft-key and select [3:SYNC] from [2:Source].

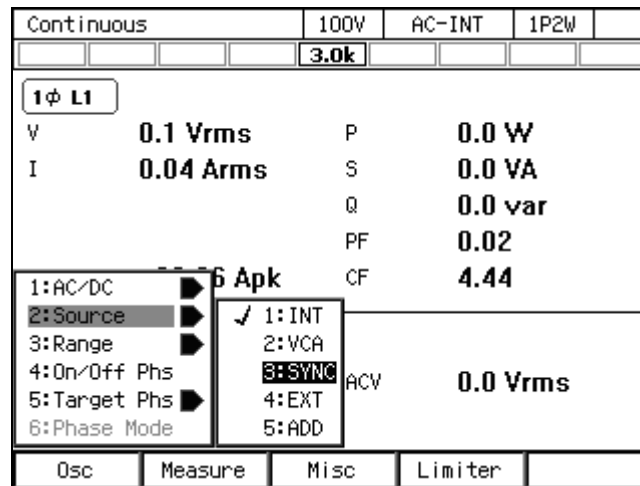

- In the [Source] item, select [Line] (power input) or [Ext] (external input signal) as the synchronization signal source.

Continuous		100V	AC-SYNC	1P2W
		3.0k	LOCK	
1φ L1		F	49.9 Hz	
V	0.1 Vrms	P	0.0 W	
I	0.04 Arms	S	0.0 VA	
		Q	0.0 var	
		PF	0.02	
Ipk-Hold	-39.66 Apk	CF	0.00	
1φ All		Source	Line	
		ACV	1:Ext	
Wave	SIN		2:Line	
Osc	Measure	Misc	Limiter	

- When the internal signal source is synchronized with the external signal or the power line, the icon **LOCK** is displayed.

4.20 Amplifying the External Signal Input

When you select EXT for the signal source, you can output the amplified external signal. Also, when you select ADD for the signal source, you can output the amplified external signal after the internal signal is added. For the specifications of the gain setting range and the input voltage range, see 10.22.3.

Notes

- The gain setting value is retained for each of 100 V/200 V ranges.
- Within the same range, the same value is retained for the gain setting value, regardless of the combination of the AC/DC mode and the signal sources (VCA, EXT, ADD).
- If the voltage after the external signal is amplified, or if the total voltage of the amplified external signal and the internal signal exceeds ± 220 V (100 V range)/ ± 440 V (200 V range), the output voltage is clipped at that value.
- If the signal source is set to EXT, the calculation is carried out in certain intervals by the measurement function of this product. Therefore, the measurement operation cycle may become inappropriate depending on the external signal frequency, resulting in the instable measured value display. In that case, set [ADD] for the signal source and configure the settings as below. When the signal source is set to [ADD], the measurement calculation is performed in optimum interval for the frequency which is set for the internal signal source. This may solve the instability of the measured value display.
 - Set the frequency for the internal signal source so that it is equal to the one for the external signal.
 - Set zero for ACV and DCV.
- You cannot amplify the external signal in the polyphase system. Also, you cannot select EXT or ADD for the signal source.

■ Operation procedure

1. Input the signal to be amplified from the external signal input connector.
2. Press the [Osc] soft-key and select [2: Source], then : select [4:EXT] or [5:ADD].

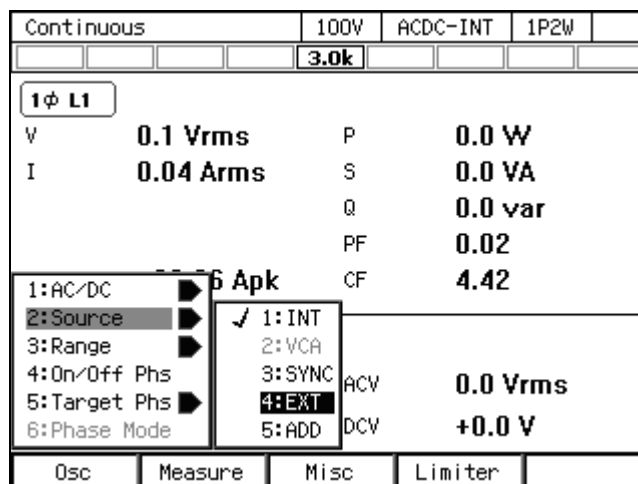

3. Set the gain in the [Gain] item.

Continuous	100V	ACDC-EXT	1P2W
	3.0k		
1φ L1			
V	0.1 Vrms	P	0.0 W
I	0.04 Arms	S	0.0 VA
		Q	0.0 var
		PF	0.02
Ipk-Hold	-39.66 Apk	CF	4.40
1φ All			
		Gain	100.0
			100.0
Osc	Measure	Misc	Limiter

4.21 Turning the Output On or Off Rapidly

In the factory default settings, the internal output relay of this product is activated linking to the output on/off. In the output off state, the internal circuit, output terminal, and the outlet of this product are physically separated. On the other hand, if the output relay chattering causes any problem, or if you want to turn the output on or off rapidly, you can disable the activation of the output relay. In that case, the output relay is fixed to the on state and the operation to turn the output on/off is performed by the semiconductor device. The output off state means the state of high impedance. Table 4-15 shows the list of the output terminal impedance (reference values in the rear output terminal) in the output off state when the output relay control is disabled.

Table 4-15 The Output Terminal Impedance in the Output Off State when the Activation of the Output Relay is Disabled

AC/DC mode	100 V range	200 V range
AC and ACDC modes	$\frac{200 \text{ k}\Omega}{4N + 3}$	$\frac{200 \text{ k}\Omega}{2N + 3}$
DC mode	$\frac{200 \text{ k}\Omega}{4N + 1}$	$\frac{200 \text{ k}\Omega}{2N + 1}$

Note 1: The reference value of output terminal at rear panel.

Note 2: N indicates the number of the power units energized.

----- Notes -----

- Even when the activation of the output relay is disabled, the relay is turned off if the protection function is activated. While the error message appearing when the protection function is activated displays "Press Enter Key," pressing the ENTER key clears the message and turns on the output relay again although the output remains off.
- The output relay is in the off state during the wait time at power-on or after changing the power unit energization setting even if the activation of the output relay is disabled.

■ Operation procedure

1. Press the MENU key to move to the root menu, then select [System]. The system setting window opens.

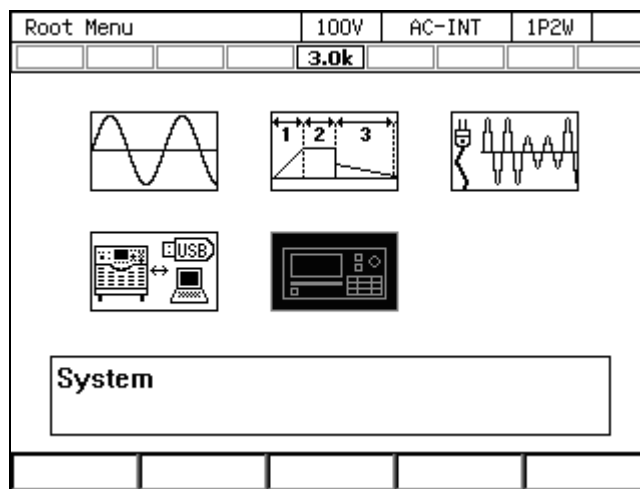

2. In the [Relay Cntrl] item, select [2:Enable] or [1:Disable]. If you select [Enable], the activation of the output relay is enabled. If you select [Disable], the output relay is fixed to the on state and the operation to turn the output on/off is performed by the semiconductor device rapidly.

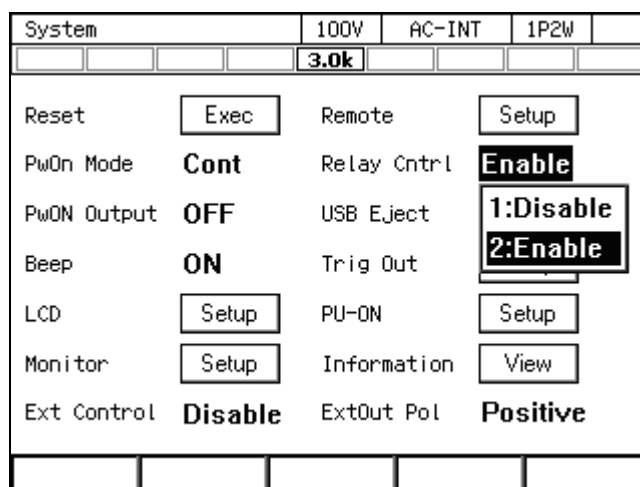

4.22 Enabling Automatic Output-On at Power-On

You can set the automatic output-on after power-on. If you set the output-on at power-on setting to [ON], the message window as shown in Figure 4-24 is displayed for about 10 seconds after you turn on the power and the self check at start-up, until the output becomes on automatically. If you press the ENTER key in the control panel, CANCEL key, or the soft-key under the [Cancel] button in the message window during this process, the output-on at power-on setting is set to off and the output is not enabled automatically. If you do not perform this key operation, the output on is enabled automatically after the message window is closed.

Notes

- The output-on at power-on setting is valid only in the Continuous function. If you set so that the Sequence or the Simulation function is selected at power-on (see 4.2.10 and 4.3.10), the output is not turned on automatically when turning on the power even if the output-on at power-on setting is set to on.
- If the unit is in the Remote state immediately after the start-up, the output-on at power-on setting is set to off and the output is not turned on automatically. The message window shown in Figure 4-24 is not displayed.
- If the unit enters the Remote state while the message window shown in Figure 4-24 is displayed, this message window closes and the output-on at power-on setting is set to off, therefore the output is not turned on automatically.



Figure 4-24 The Message Window to be Shown Before the Automatic Output-On After the Power-On

■ Operation procedure

1. Press the MENU key to move to the root menu, then select [System]. The system setting window opens.

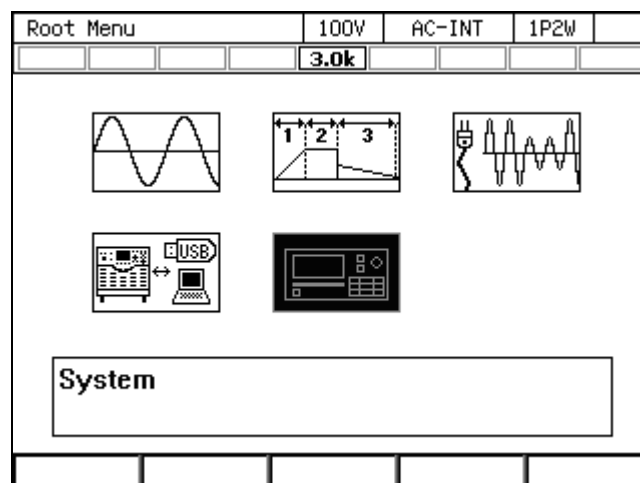

- In the [PwON Output] item, select [2:ON] or [1:OFF]. When you select [ON], the automatic output-on at power-on is enabled.

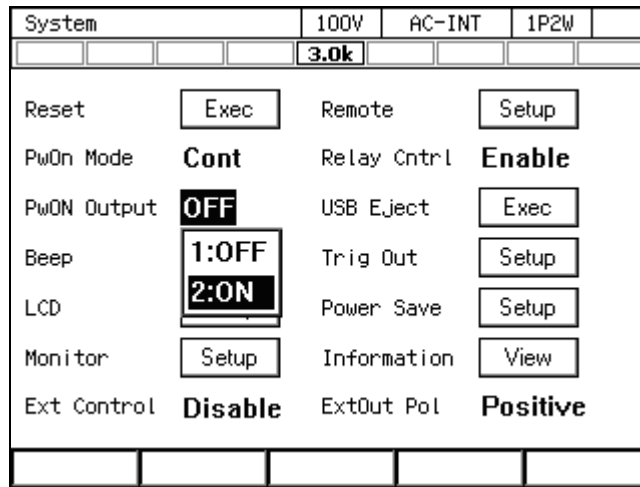

4.23 Using the Emission CO₂ Calculator

This is the function for calculating and displaying the weight of the carbon dioxide (CO₂) emission based on the measured value of the internal loss or the output power of this product. Following two measuring modes are available: Instantaneous (Unit: kgCO₂/h) and Integration (Unit: tCO₂). Users can change the coefficient for the calculation. For the specification of the emission CO₂ calculator, see 10.11.

----- Notes -----

- In the polyphase system, the emission CO₂ of the cabinet is displayed on the LCD panel of each cabinet.
 - The emission coefficient (see 4.28) is not restored to the factory default setting even if you reset this product. To restore the emission coefficient to the factory default setting, follow the procedure below. For the default setting value, see 10.11.
-

■ Operation procedure

1. Press the [Measure] soft-key and select [3:CO₂ View]. The [CO₂ View] window opens.

Continuous		100V	AC-INT	1P2W
		3.0k		
1φ L1				
V	100.0 Vrms	P	2732 W	
I	27.32 Arms	S	2732 VA	
		Q	10.8 var	
		PF	1.00	
Ipk-Hold	-39.82 Apk	CF	1.42	
1φ All		1:Mode 2:Measure 3:CO₂ View 4:Harmonic 5:Disp Item		
Freq		ACV	100.0 Vrms	
Wave				
Osc	Measure	Misc	Limiter	

2. The window shows the measured CO₂ emissions. The "Loss" represents the internal loss and the "Output" represents the output power. "Rate" represents the instantaneous and "Total" represents the integration.

Continuous		100V	AC-INT	1P2W
		3.0k		
1φ L1				
V	100.0 Vrms	P	2724 W	
CO₂ View				
Loss Rate	0.542 kgCO₂/h			
Output Rate	1.512 kgCO₂/h			
Loss Total	25.102978 tCO₂			
Output Total	2.273908 tCO₂			
Coef	0.000555 tCO₂/kWh			
	Clear	Close		

3. You can change the emission coefficient in the [Coef] item.

Continuous		100V	AC-INT	1P2W
		3.0k		
1φ L1				
V	1.8 Vrms	P	2.1 W	
CO₂ View				
Loss Rate	0.168 kgCO₂/h			
Output Rate	0.001 kgCO₂/h			
Loss Total	0.010245 tCO₂			
Output Total	0.000 554 tCO₂/kWh			
Coef	0.000555 tCO₂/kWh			
	Clear	Close		

4. If you select [Clear], the measured value in the [Total] item is cleared.

4.24 Power Unit Energization Setting (Using Under the Restricted Rated Power)

You can enable or disable the energization for each power unit (1.5 kVA per unit) within this product. If the smaller power is needed for handling the load, you can disable the energization for some power units to reduce the power consumption of this product.

If there is a power unit on which the energization is disabled, the rated power icon is displayed inverted. For details on the rated power icon, see 3.2.5 and 5.1.1.

You can disable the energization for the power unit that may have a failure while continuing operation of this product by using the remaining power units. For details, see 8.1.3.

■ Operation procedure

1. Press the MENU key to move to the root menu, then select [System]. The system setting window opens.

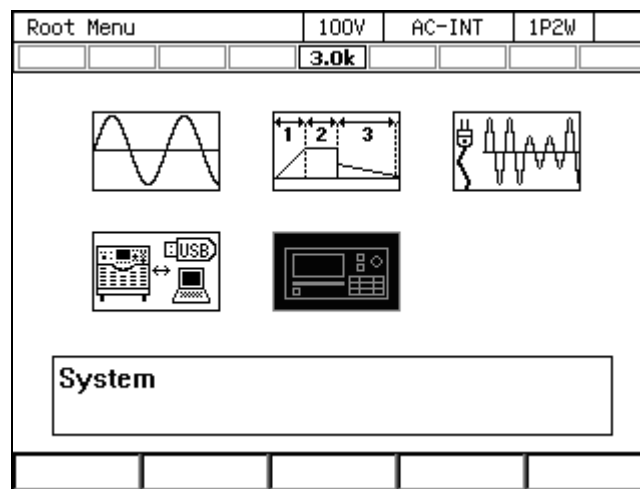

2. Put the cursor on the [Setup] next to the [PU-ON] item, then press the ENTER key. The power unit energization setting window opens.

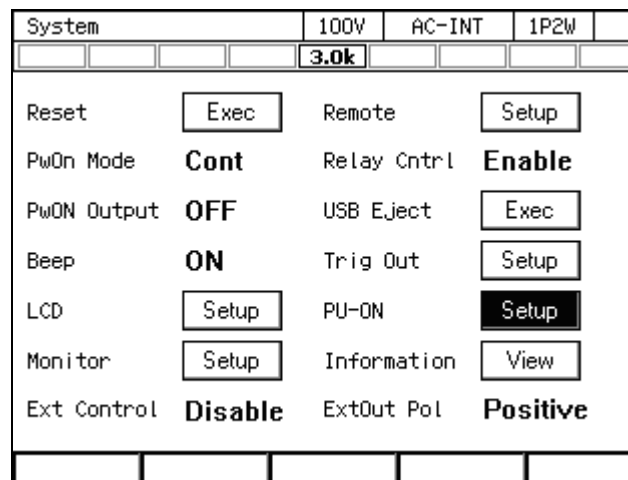

3. Enable/Disable the energization. The power unit on which the energization is enabled/disabled is represented by / respectively. Move the cursor to / and press the ENTER key to switch between and .

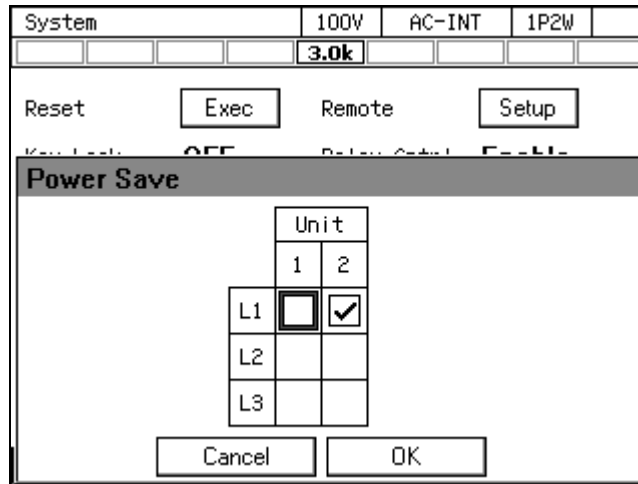

4. Select [OK]. The energization is enabled or disabled and the window is closed.

Notes

- The maximum current, current monitor gain, current measurement full scale, and the power measurement full scale are set to the values corresponding to the rated output power which is determined by the number of power units to be energized. However, the applied current measurement accuracy and the power measurement accuracy are the values under the condition where all power units are enabled for energization.
- If the number of the energized power units is changed, the setting values of the peak current limiter and the RMS current limiter are restored to the factory default settings corresponding to the rated power which is determined by the number of the power units to be energized.
- If you select [OK] without changing the energization settings in the power unit energization setting window, the energization settings of all power units are disabled once and enabled again. The setting values of the peak current limiter and the RMS current limiter are restored to the factory default settings corresponding to the rated power which is determined by the number of the power units to be energized.
- For a polyphase system, the number of power units on which the energization is enabled must be same on all phases.
- If a failure occurs in a power unit for some reason, you can disable the energization for that unit to restart using this product with the remaining power units. For details, see 8.1.3.

4.25 Key Lock

If the key lock is enabled, the operations using keys, jog, or the shuttle are not accepted. The acceptable operations are for enabling the output off and the key lock only. This function helps to avoid the incorrect user operations during running. The icon  is displayed when the key lock is enabled.

■ Operation procedure

The Shortcut operation **SHIFT** + **4** toggles between on/off of the key lock.

4.26 Beep

You can set whether or not the beep sounds when performing key operations. If the protection function is activated, the unit beeps regardless of the settings.

■ Operation procedure

1. Press the MENU key to move to the root menu, then select [System]. The system setting window opens.

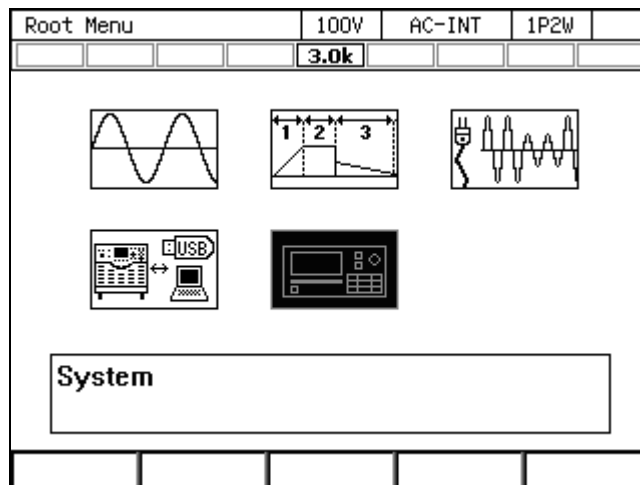

2. Use the [Beep] item to turn the beep sound on or off.

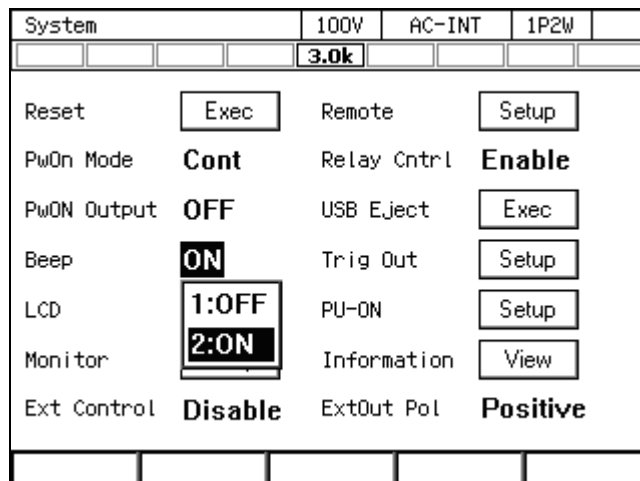

4.27 Changing the Background Color and the Contrast of the Screen

You can change the background color and the contrast of the liquid crystal display (LCD) screen on the panel. As the background color, you can select the blue tone or the white tone. You can also adjust the contrast in 100 steps. For the setting specifications, see 10.23.

■ Operation procedure

1. Open the window for adjusting the LCD. Following two methods are available.

(a) Shortcut operation: **SHIFT** + **9**

(b) Press the MENU key to move to the root menu, then select [System]. The system setting window opens. Put the cursor on [Setup] next to the [LCD] item, then press the ENTER key.

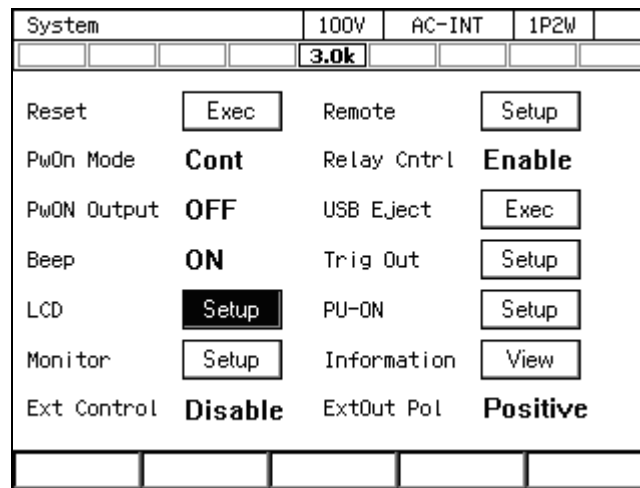

2. In the [Color] item, select [1: Blue] (blue tone) or [2: White] (white tone).

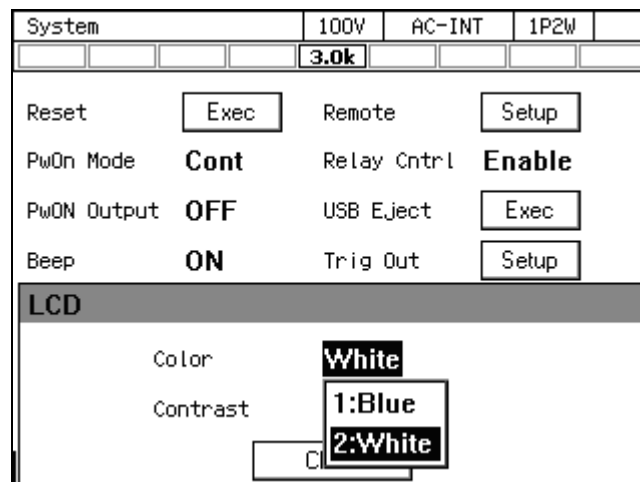

- In the [Contrast] item, set the contrast value.

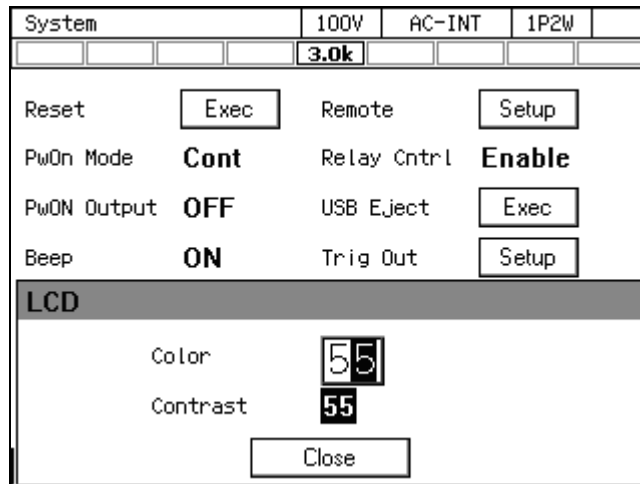

- Close the window.

----- Notes -----

- The L2 and L3 cabinets in a polyphase system accept the Shortcut operation (SHIFT) + (9) for this function. In this case, if other window such as the Emission CO₂ Calculator window is being displayed, that window closes and the window for adjusting LCD opens only on the cabinet on which you performed the operation. To open the previous window after adjusting LCD, close the window displayed in the L1 cabinet and reopen it.

4.28 Restoring to the Factory Default Setting (Reset)

If you reset this product, the setting items marked with ○ in Table 4-16 are restored to the factory default settings. Ensure that you reset this product in the output off state.

Table 4-16 Setting Items to be Reset

Setting Item	Reset	Factory default setting
Output on/off	×	Off
Output range	○	100 V range
AC/DC mode	○	AC mode
Signal source	○	INT
External synchronization signal (LINE or EXT)	○	LINE
AC voltage setting	○	0 V
Frequency	○	50 Hz
Output waveform	○	Sine wave
Output on phase	○	0.0 deg
Output off phase	○	Enabled, 0.0 deg
Phase voltage/Line voltage setting selection	○	Phase voltage
Line voltage setting	○	0 V

Table 4-16 Setting Items to be Reset (Continued)

Setting Item	Reset	Factory default setting
Phase angle setting	○	Single-phase three-wire: 180 deg Three-phase: 120, 240 deg
Balanced/Unbalanced	○	Balanced
DC voltage setting	○	0 V
Current limiter	○	Refer to 10.13
Setting range limit	○	Refer to 10.14
External input gain	○	100 V Range: 100 200 V Range: 200
Phase to be measured	○	L1
Output function	○	Continuous
DC offset	×	0 mV
Measurement display mode	○	Normal
Measurement unit selection	○	rms
Power unit energization setting	×	All enabled (energization)
Remote sensing	○	Off
AGC	○	Off
Autocal	○	Off
CO ₂ internal loss integration value	×	0.000000 tCO ₂
CO ₂ output power integration value	×	0.000000 tCO ₂
Emission CO ₂ coefficient	×	0.000555 tCO ₂ /kWh
LCD display	×	White tone
Beep	○	On
Key lock	○	Off
Output relay control	○	Enable
Output setting at power-on	○	Off
Trigger output setting	○	Negative, 10 ms
Time unit	○	s
Monitor output target	○	Current (L1 phase)
External interface	×	USB
External control input	○	Disabled
Clipped sine wave	○	Clip ratio specified Clip ratio: 100 % Crest factor: 1.41
Arbitrary Waveform Memory	×	ARB1 to 8: Triangle wave ARB9 to 16: Square wave

Table 4-16 Setting Items to be Reset (Continued)

Setting Item	Reset	Factory default setting
Sequence parameters	×	Output range: 100 V AC/DC mode: AC-INT Step Time: 0.1000 second Intra-Step behavior: Constant Waveform: SIN Frequency: 50 Hz DC voltage: 0 V AC phase voltage: 0 V Start phase: Disabled, 0 deg Stop phase: Disabled, 0 deg Phase angle: Single-phase three-wire 180 deg Three-phase 120, 240 deg Step termination: Continue Jump count: 1 Jump-to step specification: OFF Step sync output: LL Branch step specification: OFF Trigger output: Off
Simulation parameters	×	Output range: 100 V Step Time: 0.1 second Frequency: 50 Hz AC voltage: 0 V Start phase: Disabled, 0 deg Stop phase: Disabled, 0 deg Step sync output: LL Trigger output: Off Repeat count: Disabled 1

■ Operation procedure

1. Press the MENU key to move to the root menu, then select [System]. The system setting window opens.

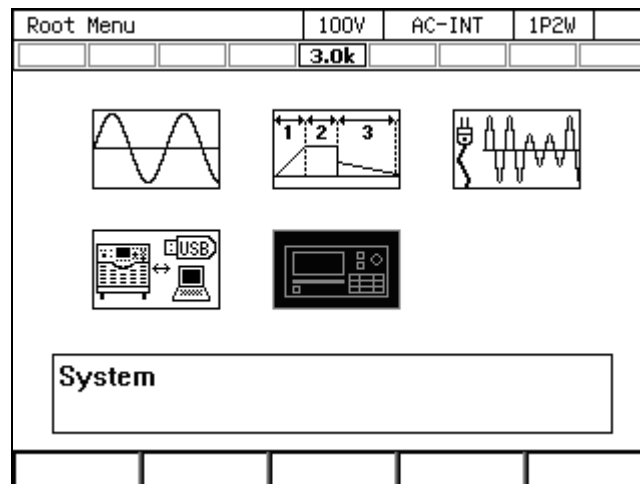

2. Put the cursor on [Exec] next to the [Reset] item, then press the ENTER key. The reset operation is performed.

System		100V	AC-INT	1P2W	
				3.0k	
Reset	Exec	Remote		Setup	
PwOn Mode	Cont	Relay Cntrl		Enable	
PwON Output	OFF	USB Eject		Exec	
Beep	ON	Trig Out		Setup	
LCD	Setup	PU-ON		Setup	
Monitor	Setup	Information		View	
Ext Control	Disable	ExtOut Pol		Positive	

----- Notes -----

- If you reset the product, the content in the Basic Setting Memory will not be cleared. Once restarted, the setting of the Basic Setting Memory No.1 is recalled. To reset the setting after restart to the factory default setting, see 4.8.1 to clear the content of the Basic Setting Memory No.1.
-

5. Description of Screen and Menu

5.1	Screen Configuration	194
5.2	Menu Composition	198

5.1 Screen Configuration

Figure 5–1 shows the basic screen configuration. It consists of display areas marked as "a" to "i". The description of each area is shown in Table 5-1.

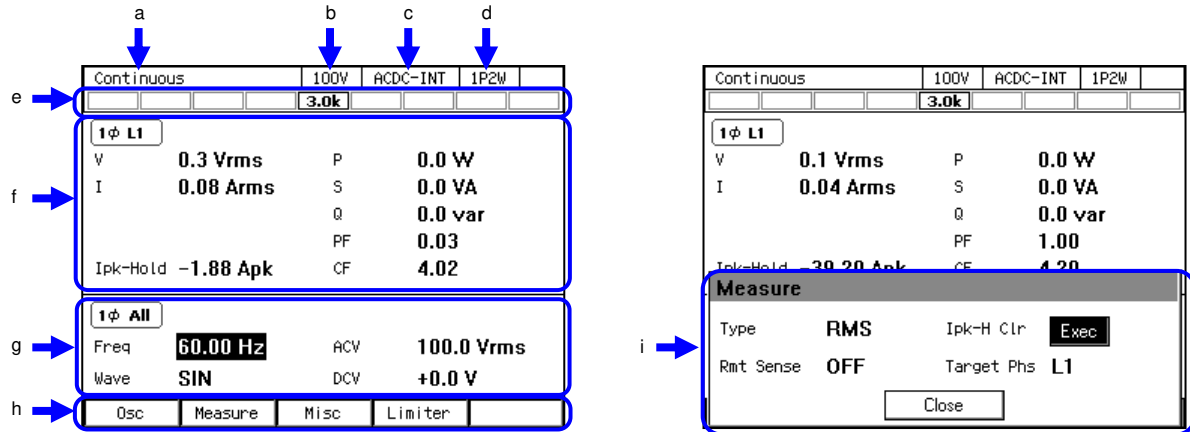

Figure 5-1 Component Name (Display Areas on the Screen)

















Table 5-1 Component Name (Display Areas on the Screen)

Symbol	Area name	Description	Refer to
a	Screen title	Title of the currently displayed screen.	—
b	Output range	Current output range.	3.4.2
c	Output mode	Current output mode. It is displayed in the format of "AC/DC mode - Signal source."	3.4.1
d	Output phase configuration	Current output phase configuration in the system. 1P2W: Single-phase two-wire/1P3W: Single-phase three-wire/3P4W: Three-phase four-wire	1.2
e	Status icon	The area where an icon is displayed when the product enters the specific state, for example, when the limiter is activated.	5.1.1
f	Measured value area	The measured values are displayed. In the Simple View, three items are enlarged.	3.4.10, 3.4.11
g	Output display area	The output setting is displayed. Make the output settings in this area.	3.4
h	Soft-key function	Shows the functions assigned to the soft-keys below.	3.3.3
i	Window	The window where the confirmation message is displayed or you change the settings. It is displayed as needed.	3.3.4

5.1.1 Status Icon

Table 5-2 shows icons displayed in specific states and their meanings.











Table 5-2 Status Icons

Icon	Name	Meaning	Refer to
	Rated power	Indicates the maximum output power. If the rated power is restricted by the power unit energization setting, the icon is displayed inverted (Example: ).	3.2.5, 4.24
	AGC	The AGC setting is on.	4.12
	Autocal	The Autocal is on.	4.13
	Busy	The product does not accept key operations for changing the setting as it is performing the internal processing. Please wait for a moment.	—
	RMS current limiter	The RMS current limiter is activated.	4.1.2
	Peak current limiter	The peak current limiter is activated.	4.1.1
	Active wattage limiter	The active wattage limiter is activated.	4.1.5
	Synchronization	With SYNC, the internal signal source is synchronized with the external signal or the power line.	4.19
	Asynchronous	With SYNC, the internal signal source is not synchronized with the external signal or the power line.	4.19
	Key lock	The key lock is enabled.	4.25
	Remote	In the Remote control state.	6.
	Editing	The edit view for the sequence or simulation is displayed.	4.2.12, 4.3.12
	Running	The sequence or simulation is running.	4.2.12, 4.3.12
	Stand by	The sequence or simulation stands by.	4.2.12, 4.3.12
	Sequence suspended	The sequence is suspended.	4.2.12, 4.3.12
	Unadjusted	Unadjusted. This icon means the abnormal state of the product. Contact us or our agent.	—

5.1.2 Measured Value Display Items

The items displayed in the measured value area are shown in Table 5-3.

Table 5-3 Measured Value Display Items

Item	Description
Icon	Represents the phase and type of the measured voltage display.
	Output voltage of the single-phase two-wire
	Phase voltage of the single-phase three-wire L1 phase
	Phase voltage of the single-phase three-wire L2 phase
	Line voltage between the single-phase three-wire L1 and L2 phases. *1
	Phase voltage of the three-phase L1 phase
	Phase voltage of the three-phase L2 phase
	Phase voltage of the three-phase L3 phase
	Line voltage between the three-phase L1 and L2 phases *1
	Line voltage between the three-phase L2 and L3 phases *1
	Line voltage between the three-phase L3 and L1 phases *1
V	Effective value of the output voltage on the output terminal
Vavg	The average DC value of the output voltage on the output terminal
Vmax	Maximum peak value of the output voltage on the output terminal
Vmin	Minimum peak value of the output voltage on the output terminal
SV	Effective value of the voltage on the sensing terminal
SVavg	Average DC value of the voltage on the sensing terminal
SVmax	Maximum peak value of the voltage on the sensing terminal
SVmin	Minimum peak value of the voltage on the sensing terminal
I *2	Output current effective value
Iavg *4	Average DC value of the output current
I _{max} *2	Maximum peak value of the output current
I _{min} *2	Minimum peak value of the output current
I _{pk-Hold} *2	Output current peak-hold value
F	Synchronization signal source frequency
P *3	Output active power
S *3	Output apparent power
Q *3	Output reactive power
PF *4	Power factor of the output power
CF *4	Output current crest factor

*1: Displays the measured phase voltage value in the Peak display format of the measured value.

Displays the L1 phase voltage in the L1-L2 line voltage display, the L2 phase voltage in the L2-L3 line voltage display, and the L3 phase voltage in the L3-L1 line voltage display.

*2: Displays the phase current in the phase voltage display for the measured output voltage, the L1 phase current in the L1-L2 line voltage display, the L2 phase current in the L2-L3 line voltage display, and the L3 phase current in the L3-L1 line voltage display.

*3: Displays the phase output power in the phase voltage display for the output voltage measurement, and the all-phase total output power in the line voltage display.

*4: Displays the phase measured value in the phase voltage display for the measured output voltage. Displays nothing in the line voltage display.

5.1.3 Output Setting Display Items

The items displayed in the output setting display area are shown in Table 5-4.

Table 5-4 Output Setting Display Items

Item	Description
Icon	Represents the phase to be configured.
1ϕ All	Output of the single-phase two-wire
2ϕ All	All phases in the balanced mode single-phase three-wire, phase voltage setting
2ϕ Line	All phases in the balanced mode single-phase three-wire, line voltage setting
2ϕ L1	L1 phase in the unbalanced mode single-phase three-wire
2ϕ L2	L2 phase in the unbalanced mode single-phase three-wire
3ϕ All	All phases in the balanced mode three-phase, phase voltage setting
3ϕ Line	All phases in the balanced mode three-phase, line voltage setting
3ϕ L1	L1 phase in the unbalanced mode three-phase
3ϕ L2	L2 phase in the unbalanced mode three-phase
3ϕ L3	L3 phase in the unbalanced mode three-phase
Freq	Frequency of the output AC voltage
Wave	Waveform of the output AC voltage
ACV	Output AC voltage
DCV	Output DC voltage
Gain	Gain of the external signal
Source	Synchronization signal source

5.1.4 Warning and Error Display

If a warning or error occurs, an error message is displayed in the measured value area and the output display area. For details on error messages, see 8.1.

5.2 Menu Composition

The menu composition of this product is shown in Figure 5–2. Press the MENU key to move to the root menu.

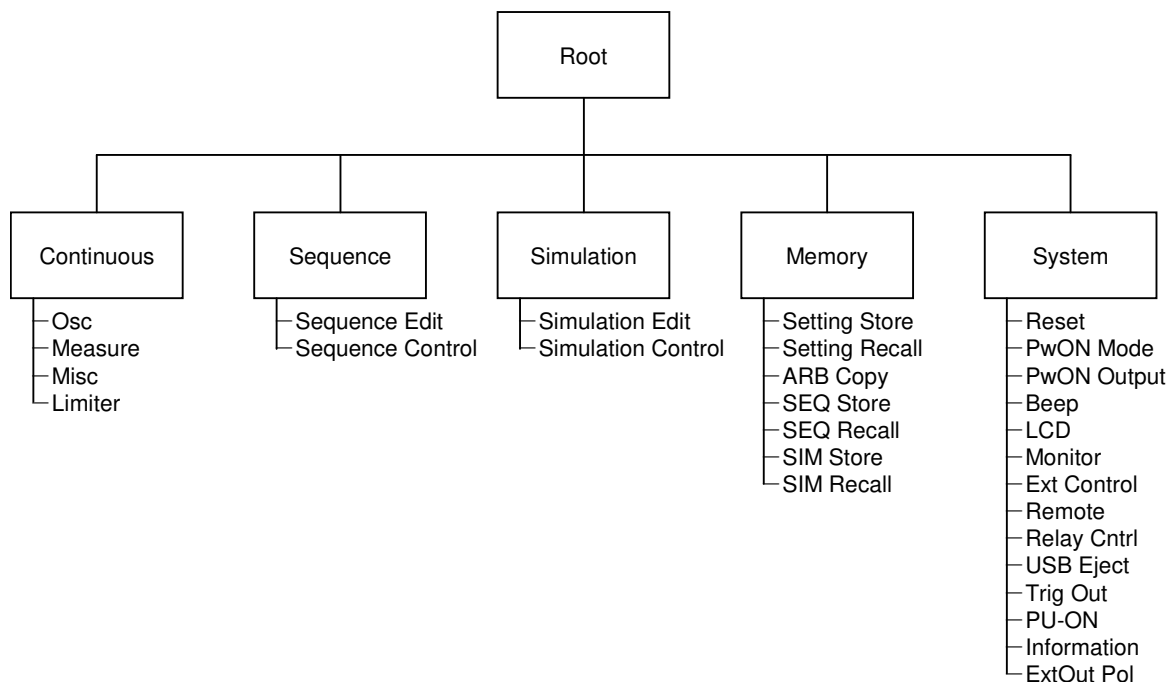

Figure 5-2 Menu Composition

5.2.1 Menus of the Continuous Function

The menus of the Continuous function are shown in Table 5-5. You can open each menu by using a soft-key.

Table 5-5 Menus of the Continuous Function

Menu	Description	Refer to	
Osc	1: AC/DC	Switches the AC/DC mode.	3.4.1
	2: Source	Switches the signal source.	3.4.1
	3: Range	Switches the output voltage range.	3.4.2
	4: On/Off Phs	Makes the on/off phase settings.	3.4.7
	5: Target Phs	Switches the phase to be configured.	3.4.5
	6: Phs Mode	Sets the phase mode in the case of polyphase output.	4.15
Measure	1: Mode	Switches the measured value display mode.	3.4.11
	2: Measure	Makes the measured value display settings.	3.4.10, 3.4.12, 3.4.13
	3: CO ₂ View	Displays and sets the CO ₂ emission.	4.21
	4: Harmonic	Displays the harmonic current measured values.	4.4
	5: Disp Item	Selects display items in the Simple measured value display mode.	3.4.11
Misc	1: AGC/Acal	Makes the AGC/Autocal function settings.	4.12, 4.13
	2: DC Adjust	Sets the DC offset adjustment.	4.14

Table 5-5 Menus of the Continuous Function (Continued)

Menu		Description	Refer to
Limiter	1: Ipk Limiter	Makes the peak current limiter settings.	4.1.1
	2: Irms Limiter	Makes the RMS current limiter settings.	4.1.2
	3: V/F Limiter	Sets the voltage/frequency setting range limit.	4.1.3,4.1.4

5.2.2 Menus of the Sequence Function

The menus of the Sequence function are shown in Table 5-6. You can open each menu by using a soft-key. For how to use the Sequence function, see 4.2.

Table 5-6 Menus of the Sequence Function

Menu		Description	
Sequence Edit	Osc	Range	Switches the output voltage range.
		AC/DC	Switches the AC/DC mode.
	Misc	Time Unit	Switches the time unit between ms and s.
		Trig Out	Sets the trigger output.
	File	Store	Saves to, clears, and renames the Sequence Memory.
		Recall	Recalls the Sequence Memory.
	Clear	Resets the edited sequence to the factory default settings.	
	Compile	Compiles the edited sequence and moves to the Sequence Control View.	
Sequence Control	Start	Starts the sequence. It is displayed in the output on and sequence stopped states.	
	Stop	Ends the sequence. It is displayed in the sequence running state.	
	Hold	Suspends the sequence. It is displayed in the sequence running state.	
	Resume	Resumes the suspended sequence. It is displayed in the sequence suspended state.	
	Bran1	Branches to a step of the branch 1. It is displayed in the sequence running state.	
	Bran2	Branches to a step of the branch 2. It is displayed in the sequence running state.	
	Measure	Makes the measured value display settings. It is displayed in the sequence stopped state.	
	Edit	Displays the Sequence Edit View. It is displayed in the output off state.	

5.2.3 Menus of the Simulation Function

The menus of the Simulation function are shown in Table 5-7. You can open each menu by using a soft-key. For how to use the Simulation function, see 4.3.

Table 5-7 Menus of the Simulation Function

Menu		Description	
Simulation Edit	Osc	Range	Switches the output voltage range.
	Misc	Time Unit	Switches the time unit between ms and s.
		Trig Out	Sets the trigger output.
	File	Store	Saves to, clears, and renames the Simulation Memory.
		Recall	Recalls the Simulation Memory.
	Clear		Resets the edited simulation to the factory default settings.
Compile		Compiles the edited simulation and moves to the Simulation Control View.	
Simulation Control	Start		Starts the simulation. It is displayed in the output on and simulation stopped states.
	Stop		Ends the simulation. It is displayed in the Simulation running state.
	Measure		Makes the measured value display settings. It is displayed in the simulation stopped state.
	Edit		Moves to the Simulation Edit View. It is displayed in the output off state.

5.2.4 Menus of the Memory Function

The means of the Memory function are shown in Table 5-8. For how to use the Memory function, see 4.8.

Table 5-8 Menus of the Memory Function

Menu	Description
Setting Store	Saves to, clears, and renames the Basic Setting Memory.
Setting Recall	Recalls the Basic Setting Memory.
ARB Copy	Copies the arbitrary waveform data between the internal memory and the USB memory, and clears and renames it.
SEQ Store	Saves to, clears, and renames the Sequence Memory.
SEQ Recall	Recalls the Sequence Memory.
SIM Store	Saves to, clears, and renames the Simulation Memory.
SIM Recall	Recalls the Simulation Memory.

5.2.5 System Menus

The System menus are shown in Table 5-9.

Table 5-9 System Menus

Menu	Description	Refer to
Reset	Resets the system.	4.28
PwOn Mode	Selects the output function (Continuous/Sequence/Simulation) at power-on.	4.2.10, 4.3.10
PwON Output	Enables/disables the function to turn on the output at power-on.	4.22
Beep	Turns the beep sound on or off.	4.26
LCD	Sets the screen color and the contrast.	4.27
Monitor	Makes the Monitor function settings.	4.10
Ext Control	Enables/disables the external control.	4.18
Remote	Makes the communication interface settings.	6.1
Relay Cntrl	Enables/disables the output relay to coordinate with the output on/off.	4.21
USB Eject	Disconnects the USB memory before removing it.	4.9
Trig Out	Makes the trigger output settings in the Sequence and the Simulation.	4.2,4.3
PU-ON	Makes the power unit energization settings.	4.24
Information	Displays the system information.	9.4
ExtOut Pol	Specifies the external control state output polarity.	4.18

6. Remote Control

6.1	Communication Interface.....	204
6.2	Remote/Local State Switching	213

6.1 Communication Interface

This product is provided with the USB and RS232 communication interfaces as standard and is remote-controllable by a computer. Also, either GPIB or LAN communication interface can be chosen when ordering. The remote control allows almost all the operations available on the control panel to be performed. In addition, it can read the internal state such as setting values and errors. The command language is compliant with the SCPI Specification 1999.0.

Regardless of which communication interface is used, you can create and use a program that uses the Virtual Instrument Software Architecture (VISA) library. If you do not have a license to use VISA library, you need to obtain one (generally, it requires some cost).

"Instruction Manual (Remote Control)" can be downloaded from our website. It is also included within an optional Control Software CD-ROM.

6.1.1 USB

The product is compliant with the USB Test and Measurement Class(USBTMC). Normally, the USBTMC class driver supports the sub class USB488 and can perform almost the same controls as GPIB on USB.

■ Preparation

The computer used for control needs a USBTMC class driver installed on it. The USBTMC class driver is included in the hardware and software product of each company that provides the VISA library.

■ Operation procedure

1. Press the MENU key to move to the root menu, then select [System]. The system setting window opens.

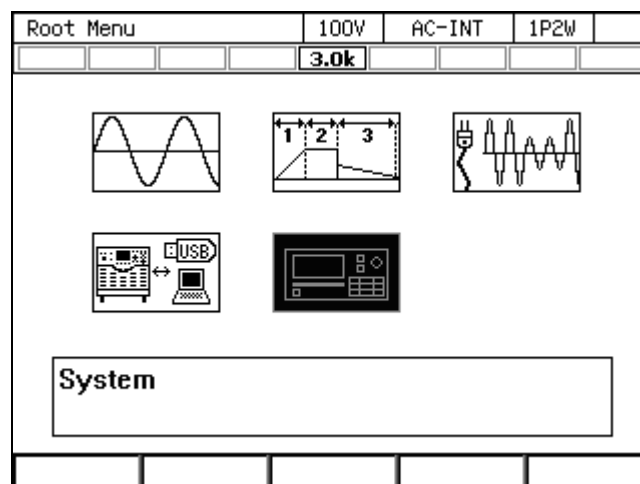

- 2. Put the cursor on [Setup] next to the [Remote] item, then press the ENTER key. The remote setting window opens.

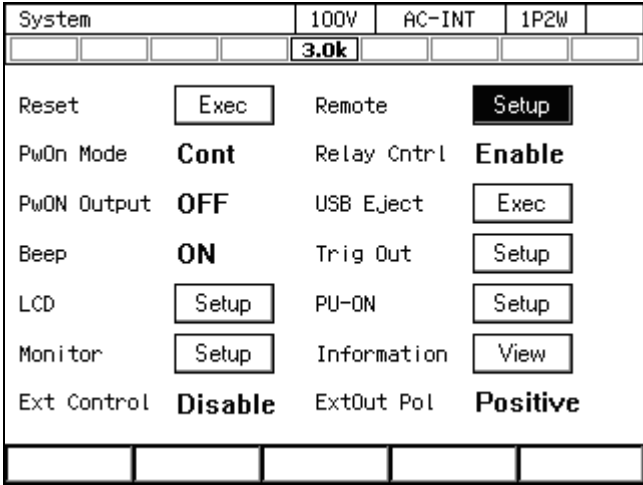

- 3. In the [Interface] item, select [USB].

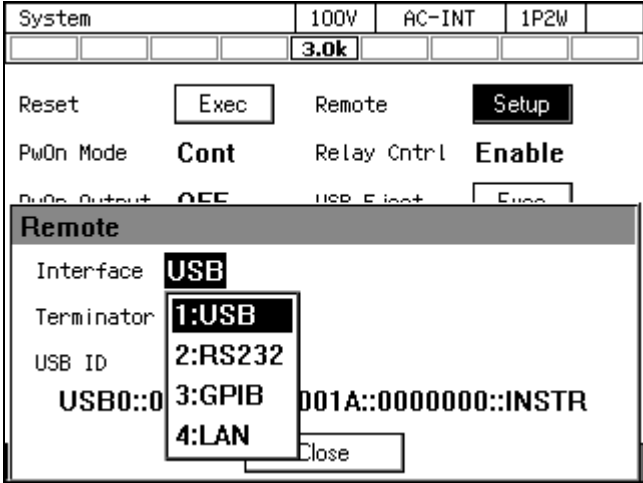

- 4. The window shows [Terminator] and [USB ID]. For the USB ID, see the explanation in the next section. Select [OK] to close the window.

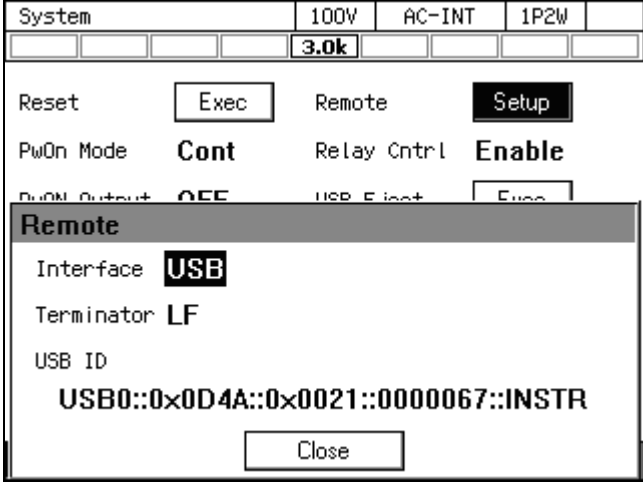

5. Use a commercially available USB cable (Type A to B) to connect this product to the computer. USB connector is available on the rear of this product.

----- Notes -----

- Avoid use in a place under electrically noisy environment.
 - It is recommended to use a fully-shielded, short cable.
 - The use of USB hub may cause the product not to communicate properly.
-

■ About USB ID

Used for a system connected with multiple KP3000S programmable AC/DC power sources through USB, to enable the application identify each source. The USB ID is represented in the following format.

USB0::[Vendor number]::[Product number]::[Serial number]::INSTR

Vendor number: Fixed to 3402 (0x0D4A)

Product number: Fixed to 33 (0x0021)

Serial number: A unique number (serial number) has been set for each product.

6.1.2 RS232

For the interface specifications, see 10.27.

■ Operation procedure

1. Press the MENU key to move to the root menu, then select [System]. The system setting window opens.

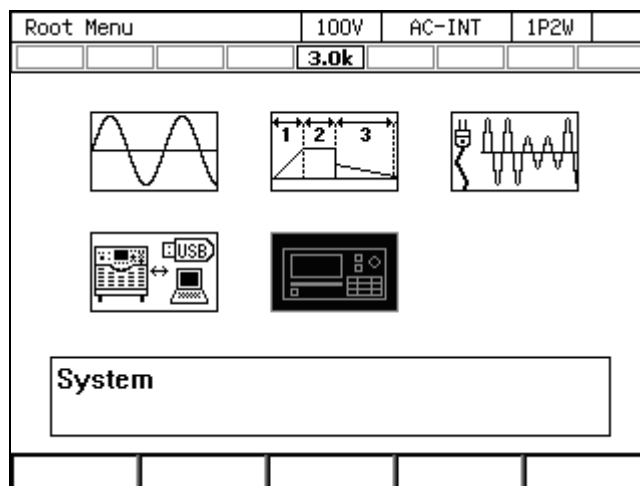

- Put the cursor on [Setup] next to the [Remote] item, then press the ENTER key. The remote setting window opens.

System	100V	AC-INT	1P2W
	3.0k		
Reset	Exec	Remote	Setup
PwOn Mode	Cont	Relay Cntrl	Enable
PwON Output	OFF	USB Eject	Exec
Beep	ON	Trig Out	Setup
LCD	Setup	PU-ON	Setup
Monitor	Setup	Information	View
Ext Control	Disable	ExtOut Pol	Positive

- In the [Interface] item, select [RS232].

System	100V	AC-INT	1P2W
	3.0k		
Reset	Exec	Remote	Setup
PwOn Mode	Cont	Relay Cntrl	Enable
PwON Output	OFF	USB Eject	Exec
Remote			
Interface	USB		
Terminator	1:USB		
USB ID	2:RS232		
	3:GPIB	001A::0000000::INSTR	
	4:LAN		
			Close

- Set each item.

System	100V	AC-INT	1P2W
	3.0k		
Reset	Exec	Remote	Setup
PwOn Mode	Cont	Relay Cntrl	Enable
PwON Output	OFF	USB Eject	Exec
Remote			
Interface	RS232		
Baud Rate	9600bps	Parity	None
Terminator	CR/LF	Stop bit	1bit
Char bit	8bit	Flow Control	None
	Cancel	OK	

5. Use a D-sub 9-pin cross cable to connect this product to the computer. The connector is on the rear of this product.

----- Notes -----

- Avoid use in a place under electrically noisy environment.
 - Turn off this product and the computer before connecting or disconnecting the cable.
 - Binary transmission is not supported.
-

6.1.3 GPIB

The product is compliant with the GPIB IEEE Standard 488.1-1987. The GPIB-based remote control is available. For the interface specifications, see *10.27*.

■ Operation procedure

1. Press the MENU key to move to the root menu, then select [System]. The system setting window opens.

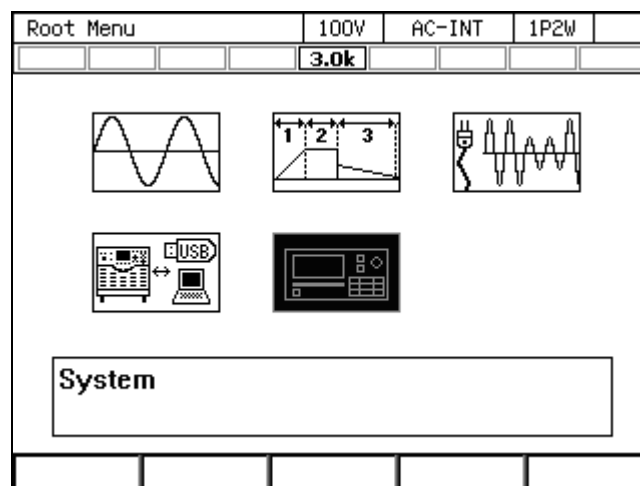

- Put the cursor on [Setup] next to the [Remote] item, then press the ENTER key. The remote setting window opens.

System	100V	AC-INT	1P2W
	3.0k		
Reset	<input type="button" value="Exec"/>	Remote	<input checked="" type="button" value="Setup"/>
PwOn Mode	Cont	Relay Cntrl	Enable
PwON Output	OFF	USB Eject	<input type="button" value="Exec"/>
Beep	ON	Trig Out	<input type="button" value="Setup"/>
LCD	<input type="button" value="Setup"/>	PU-ON	<input type="button" value="Setup"/>
Monitor	<input type="button" value="Setup"/>	Information	<input type="button" value="View"/>
Ext Control	Disable	ExtOut Pol	Positive

- In the [Interface] item, select [GPIB].

System	100V	AC-INT	1P2W
	3.0k		
Reset	<input type="button" value="Exec"/>	Remote	<input checked="" type="button" value="Setup"/>
PwOn Mode	Cont	Relay Cntrl	Enable
PwON Output	OFF	USB Eject	<input type="button" value="Exec"/>
Remote			
Interface	USB		
Terminator	1:USB		
USB ID	2:RS232		
	3:GPIB	001A::0000000::INSTR	
	4:LAN		
<input type="button" value="Close"/>			

- In the [Address] item, set the address. [Terminator] is fixed to "LF".

System	100V	AC-INT	1P2W
	3.0k		
Reset	<input type="button" value="Exec"/>	Remote	<input checked="" type="button" value="Setup"/>
PwOn Mode	Cont	Relay Cntrl	Enable
PwON Output	OFF	USB Eject	<input type="button" value="Exec"/>
Remote			
Interface	GPIB		
Address	2	Terminator	LF
<input type="button" value="Close"/>			

5. Use a GPIB cable to connect this product to the computer. The connector is on the rear of this product. Turn off this product and the computer before connecting or disconnecting the cable.

Notes

- Avoid use in a place under electrically noisy environment.
 - Before connecting or disconnecting the connector, turn off the power to all devices on the bus.
 - When using the GPIB, turn on the power to all devices on the bus.
 - Ensure that the total cable length is within 20 meters.
 - Ensure that the length of one cable is within 4 meters.
 - Do not set the same address as the one used for any other device connected to the same bus. Otherwise, the product cannot communicate properly.
 - Binary transmission is not supported.
 - Query for the main unit status byte using a serial poll is not supported.
-

6.1.4 LAN

For the interface specifications, see *10.26*.

For how to set LAN interface, refer to the Instruction Manual (Remote Control).

■ Operation procedure

1. Connect this product and computer with LAN cable. LAN connector is available on the rear of this product. Turn off this product and the computer before connecting or disconnecting the cable.
2. Press the MENU key to move to the root menu, and then select [System]. The system setting window opens.

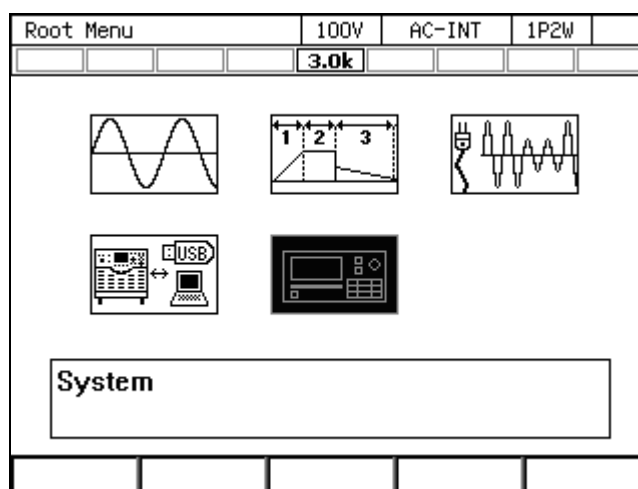

3. Put the cursor on [Setup] next to the [Remote] item, then press the ENTER key. The remote setting window opens.

System	100V	AC-INT	1P2W
	3.0k		
Reset	<input type="button" value="Exec"/>	Remote	<input type="button" value="Setup"/>
PwOn Mode	Cont	Relay Cntrl	Enable
PwON Output	OFF	USB Eject	<input type="button" value="Exec"/>
Beep	ON	Trig Out	<input type="button" value="Setup"/>
LCD	<input type="button" value="Setup"/>	PU-ON	<input type="button" value="Setup"/>
Monitor	<input type="button" value="Setup"/>	Information	<input type="button" value="View"/>
Ext Control	Disable	ExtOut Pol	Positive

4. In the [Interface] item, select [LAN].

System	100V	AC-INT	1P2W
	3.0k		
Reset	<input type="button" value="Exec"/>	Remote	<input type="button" value="Setup"/>
PwOn Mode	Cont	Relay Cntrl	Enable
PwOn Output	OFF	USB Eject	<input type="button" value="Exec"/>
Remote			
Interface	USB		
Terminator	1:USB		
USB ID	2:RS232		
USB0::0	3:GPIB	001A::0000000::INSTR	
	4:LAN		
	<input type="button" value="Close"/>		

- The current [MAC Address], [IP Address], [Subnet mask] and [Gateway] are displayed. When not using fixed IP, *** is displayed because it is uncertain except for MAC Address immediately after interface switching. After assignment, the display such as IP Address will be updated. Refer to the matters for IP address setting etc. For details, refer to "Instruction Manual (Remote Control)" contained in the CD-ROM.

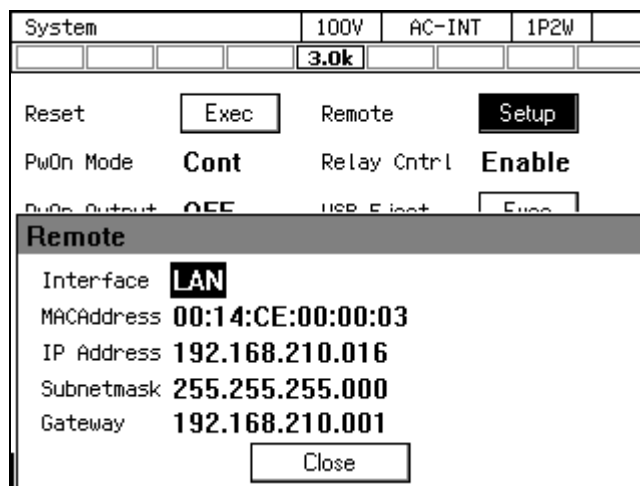
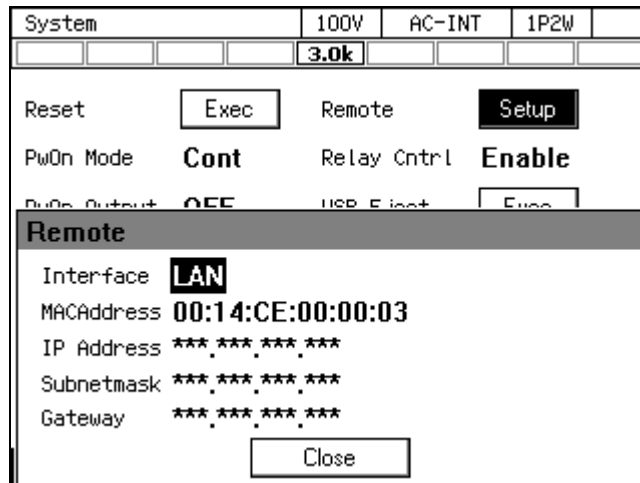

- MAC Address : Device-specific address (physical address). It cannot be changed. It is 8 bit delimited, hexadecimal notation.
- IP Address : In IP (Internet Protocol), you can check the address (logical address) for identifying the device. The range from 192.168.0.0 to 192.168.255.255 is a private IP address that you can freely use in a small local network (Class C).
- Subnet mask : You can check the mask that separates the upper network address and the lower host address from the IP address.
- Gateway : When accessing an external network, you can check the IP address of the gateway (repeater) to use implicitly.

Notes

- Avoid use in a place under electrically noisy environment.
 - Turn off this product and the computer before connecting or disconnecting the cable.
 - Binary transmission is not supported.
-

6.2 Remote/Local State Switching

6.2.1 Remote State

In the Remote state, the control panel key operations are not accepted. However, the output off (OUTPUT key) and the switching to the Local state (**SHIFT** + **O**) are accepted.

■ Switching to the Remote state

When communication is established after the command is sent from the computer to this product, this product switches to the Remote state.

6.2.2 Local State

Control panel key operations are accepted.

■ Switching to the Local state

The Shortcut operation **SHIFT** + **O** switches to the state to Local.

7. Options

7.1	Outlet	216
7.2	Casters	216
7.3	Application Software	216
7.4	System Cable (for Polyphase System)	217
7.5	Remote Controller	217
7.6	Replacement Air Filter	218
7.7	Rack-Mount Adapter	218
7.8	Additional Cable	218

7.1 Outlet

Two outlets for Japan/North America (NEMA 5-15, available in 100 V range) are added at the lower front. The output terminals, the maximum voltage, the maximum current, and available output range are listed in Table 7-1. The outlet is dedicated to AC output. It can be used in the AC or ACDC mode. For information on outlet, see 2.5.

Table 7-1 Outlet

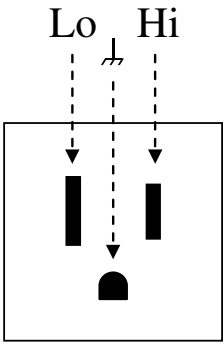
Type	NEMA 5-15
Form And Terminal	
Maximum Voltage	125 Vrms
Maximum Current	15 Arms
Available Output Range	100 V range

Model name: PA-001-1963

Product name: Outlet

7.2 Casters

Casters with the freely movable front-wheels and fixed rear-wheels which can be used to move this product in the horizontal location and an adjuster foot are added. This option can be added after the purchase. Descriptions for the caster type in this document applies when this option is attached, see 2.3.

Model name: PA-001-1964

Product name: Casters

7.3 Application Software

This program supports the panel operation, arbitrary waveform edition/transfer/USB memory export, measurement data logging, sequence edition/USB memory export/execution, and simulation edition/USB memory export/execution via a personal computer.

Model name: PA-001-1965

Product name: Control Software for KP Series

7.4 System Cable (for Polyphase System)

This cable is used to configure the polyphase system by connecting two or three KP3000Ss. This option can be requested at the time of order or added after the purchase. For how to configure the polyphase system, see 2.5.1.

Model name: PA-001-1720

Product name: System Cable (1P3W)

Model name: PA-001-1721

Product name: System Cable (3P4W)

7.5 Remote Controller

A remote controller with the numeric keypad, jog, and shuttle. It supports almost all the operations available on the main unit control panel. This option can be requested at the time of order or added after the purchase. For the remote controller operations, see the instruction manual that comes with the remote controller.

Model name: DP008

Product name: Remote Controller

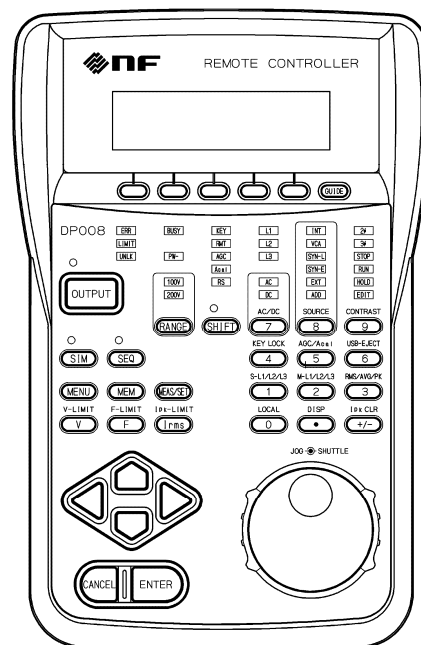

Figure 7-1 Remote Controller External View

7.6 Replacement Air Filter

A replacement air filter on the front grill. This option can be requested at the time of order or added after the purchase.

Model name: PA-001-1966

Product name: Replacement air filter

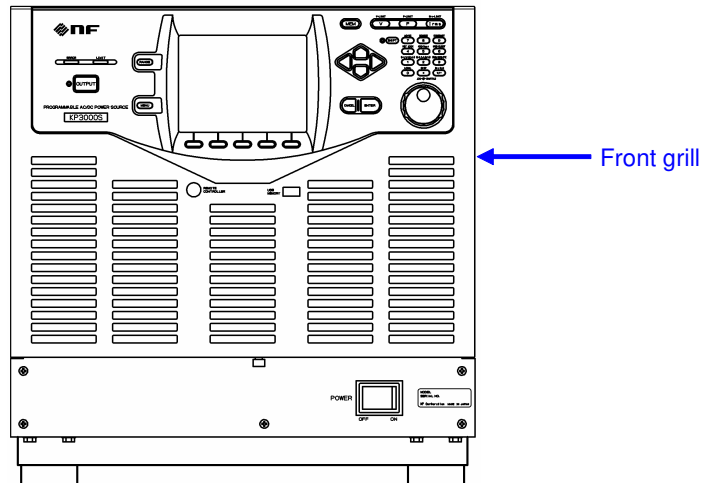

Figure 7-2 Front Grills

7.7 Rack-Mount Adapter

The rack-mount adapter is a set of brackets used to mount the product on the EIA or JIS standard compliant rack. This option can be requested at the time of order or added after the purchase.

Table 7-2 Rack-Mount Adapter Model Names

Model name	Product name
PA-001-1728	Rack-mount adapter(inch)
PA-001-1732	Rack-mount adapter(mm)

7.8 Additional Cable

When you need two or more cables, or when you change the power supply environment, and so on, you can request at the time of order or after the purchase.

Model name: PA-001-1973

Product name: Additional power cable for 100 V AC input

Model name: PA-001-1974

Product name: Additional power cable for 200 V AC input

8. Troubleshooting

8.1	Error Messages and Error Handling	220
8.2	When a Failure is Suspected	227

8.1 Error Messages and Error Handling

8.1.1 Error Message Screen

An error message screen opens as shown in Figure 8–1, for example, in case that the protection function is activated. The description of each item is shown in Table 8-1.

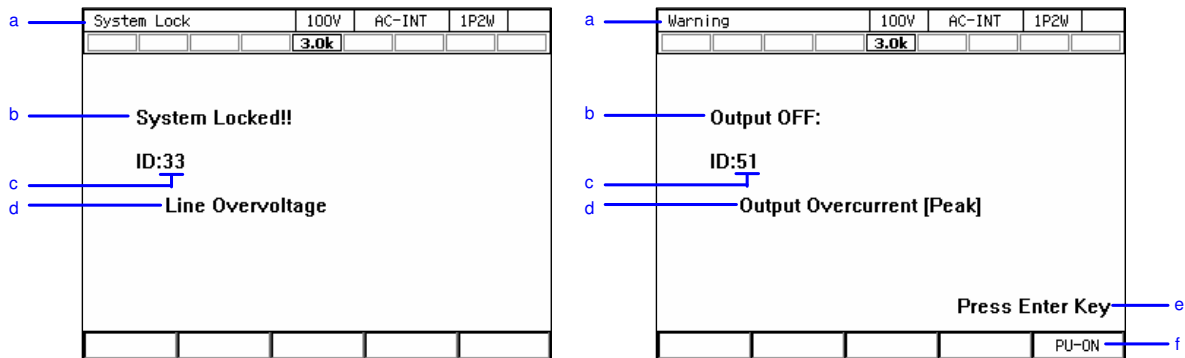

Figure 8-1 Error Message Screen Example

Table 8-1 Description of the Error Message Screen

Symbol	Name	Description	Refer to
a	Screen title	System Lock: An error whose protection type is System Lock Warning: An error whose protection type is Output Off	8.1.4
b	Protection type	System Locked: System Lock Output OFF: Output Off	8.1.4
c	Error ID	The number to identify an error.	8.1.5
d	Message	Describes the error details.	8.1.5
e	Press Enter Key	Displayed for an error whose protection type is Output Off.	8.1.2
f	Soft-key [PU-ON]	Displayed for an error that occurred on the power unit. This key opens the power unit energization setting window, enabling you to disable the energization of the power unit that repeatedly generates the error.	8.1.3

8.1.2 If An Error Message is Displayed

If an error message is displayed, handle it by the following procedure. When the error occurs repeatedly, handle it according to 8.1.3.

■ Handling procedure

1. Check on the error content and remove the reason of the error. For each message and its handling method, see 8.1.5.
2. When the protection type says System Locked, cycle the power of the product.
3. When the protection type says Output OFF, press the ENTER key. The error message disappears.
4. Now the product is available.

8.1.3 If An Error Occurs Repeatedly

If an error message repeatedly appears even though you removed the cause of the error, the error may be resolved by restarting the power unit.



If the error still exists, this product or the power unit in the product may be faulty. Repair is needed in this case. Contact the seller (NF Corporation or our agent) from whom you purchased the product. Even though one of the power units is faulty, the product can be used by disconnecting the faulty power unit and using the rest of them.

The following shows how to restart and disconnect the power unit in the case of an error.

Notes

- The following procedure is available only when the [PU-ON] soft-key is displayed on the error message window. Stop using this product in the case of a repeating error without the [PU-ON] soft-key.

■ Operation procedure

1. In the error message window, press the [PU-ON] soft-key. The power unit energization setting window opens.
2. The power unit with an error is marked with "E" like . Check on the power unit that has an error. First, leaving the energization setting as is, select OK. All the power units are restarted.
3. When the error message window is displayed again, press the ENTER key.
4. If the error still exists, press the [PU-ON] soft-key again to open the power unit energization setting window.
5. Check on the power unit that has an error. If the same power unit still has an error, it may be faulty. Move the cursor to this power unit, then press the ENTER key. The check mark on this power unit is removed, showing . If a different power unit has an error, leave the check mark as is. Select [OK].
6. The power unit energization setting is updated, and only the power units with the check mark are restarted. When the error message window is displayed again, press the ENTER key.
7. Repeat the step 4 and later ones until errors are resolved. After the error is resolved, the product can be continuously used using the power units with the check mark.

- Notes -----
- The E mark does not mean it is faulty but indicates the protection operation was activated. In some cases such as the protection operation was activated in a chain-reaction manner, the E mark may appear on a normal power unit. A power unit is judged as faulty by checking whether the error repeats or not after the power unit is restarted as described in the step 2.
 - When the error message is "ID:54 Power Unit DCPS Undervoltage" or "ID:52 Power Unit DCPS Error," the error is quite likely to be resolved after the power unit is restarted as described in the step 2.
-

8.1.4 Protection Operation Types

When the protection function is activated or an error is detected, the product applies one of the following five types of protection operation and error message, according to the error level.

■ System Lock

The output turns off. No operations are accepted on the control panel and the remote controller. The panel says "System Locked." To operate the product again, it is necessary to cycle the power of it.

■ Output Off

The output turns off. The panel says "Output OFF" and "Press Enter Key." When you press the ENTER key, you will return to the previous window for further operations if the cause of the error has been removed. Otherwise, the error message window will be displayed again.

When the [PU-ON] soft-key is displayed on the error message window, pressing the soft-key opens the power unit energization setting window. If an error repeatedly occurs, you can disable the energization of the power unit that has the error to continue to use the product with the rest of the power units. For details, see *8.1.3*.

■ Message display only

The output state remains unchanged. The panel shows the error message window. Press the ENTER key to return to the previous screen for further operations.

■ Limiting action

The output is limited. The panel shows the icon indicating the limiting action, without an error message. In addition, the LIMIT LED illuminates on the front panel. The output turns off after a given period according to the limiter setting. In this case, an error message appears after the output off.

■ Icon display

The output state remains unchanged. The panel shows an icon instead of an error message. The panel operation is available as usual.

8.1.5 Error Message List

Error messages are listed in Table 8-2.

Table 8-2 Error Message List

ID	Message	Protection type	Cause or Necessary action
2	Invalid in This Output Mode	Message display only	This output mode does not allow the setting (execution). Change the output mode.
3	Invalid with Output ON	Message display only	The output on state does not allow the setting (execution). Turn the output off, then set (execute).
4	Invalid with Output OFF	Message display only	The output off state does not allow the setting (execution). Turn the output on, then set (execute).
5	Busy	Message display only	The busy state does not allow the setting (execution). Execute after the busy icon disappears.
6	Invalid with Remote Control	Message display only	The remote control state does not allow the setting (execution). Bring the state to local control, then set (execute).
10	Sync Frequency Error	Message display only	The external synchronization signal frequency is out of the range, which does not allow the setting (execution). Enter the signal frequency within the range.
13	Auto Cal Disabled	Message display only	The Autocal setting becomes off because of out of the calibration range.
15	AGC Disabled	Message display only	The AGC setting becomes off because of out of the calibration range.
20	Invalid	Message display only	The condition cannot be set (executed).
24	USB Memory Unconnected	Message display only	No USB memory is connected. Connect a USB memory.
25	USB Memory Removed illegally	Message display only	The USB memory was removed before the eject operation. Perform the eject operation before removing a USB memory.
26	USB Memory Access Error	Message display only	The USB memory has an access error.
27	Too Many Files	Message display only	There are too many files in the USB memory. Each folder can contain 500 files or less.
29	Sync Frequency Unlocked	Message display only	The output cannot be turned on because of not locking to the synchronization frequency.
30	Remote Controller Error	Message display only	Communication with the remote controller cannot be made. Make sure the remote controller cable is connected properly.
31	Internal Memory Error	Message display only	The internal memory has an error.

Table 8-2 Error Message List (Continued)

ID	Message	Protection type	Cause or Necessary action
32	Calibration Data Error ME	Message display only	The adjustment data is abnormal. Cycle the power. If it still occurs, contact the seller (NF Corporation or our agent) from whom you purchased the product.
33	Line Overvoltage	System Lock	The power input voltage is excessive. Check if the power input is appropriate.
34	Line Undervoltage	System Lock	The power input voltage is insufficient. Check if the power input is appropriate.
36	Communication Failure PU	System Lock	There is a communication error between the firmware and the power unit. Cycle the power. If it still occurs, contact the seller (NF Corporation or our agent) from whom you purchased the product.
37	Communication Failure ME	System Lock	There is a communication error between the firmware and the output measurement section. Cycle the power. If it still occurs, contact the seller (NF Corporation or our agent) from whom you purchased the product.
38	Communication Failure SC	System Lock	The polyphase system communication is abnormal. Make sure the System Cable is connected properly.
40	Polyphase Connection Timeout	System Lock	In the polyphase system, the connection destination cannot be recognized in the specified time. Make sure the System Cable is connected properly, then turn on the power of all the cabinets in 20 seconds.
41	Mismatched Firmware Versions	System Lock	In the polyphase system, the main firmware versions of the cabinets do not match.
43	Mismatched Pw Unit Versions	System Lock	All power unit versions do not match.
44	Unsupported Pw Unit Version	System Lock	A power unit of unsupported version is connected.
45	Mismatched Cabinet Connect	System Lock	In the polyphase system, the output capacities of the phases do not match.
47	No Available Power Unit	System Lock	There is no power unit that can be started.
48	Output Overvoltage	Output Off	The output voltage is excessive. This may occur at an abrupt change in the output current due to the inductive load.

Table 8-2 Error Message List (Continued)





ID	Message	Protection type	Cause or Necessary action
50	Output Overcurrent [RMS]	Output Off	The output current RMS value is excessive on a module in the power unit. This may occur when the output terminal is short-circuited.
51	Output Overcurrent [Peak]	Output Off	The output current peak value is excessive.
52	Power Unit DCPS Error	Output Off	The DC power supply in the power unit is abnormal, or see the notes in "8.1.3, Operation procedure."
53	Power Unit DCPS Overvoltage	Output Off	The voltage of the DC power supply in the power unit is excessive. This may occur when the power flows back from the load.
54	Power Unit DCPS Undervoltage	Output Off	The voltage of the DC power supply in the power unit is insufficient, or see the notes in "8.1.3, Operation procedure." This may occur when the overload output activated the protection function on the DC power supply.
55	Overheat	Output Off	The temperature in the power unit is abnormally high. Check if the ambient temperature is appropriate. Check the filters for clogging. For filter cleaning, see 9.2.
56	Sensing Voltage Error	Output Off	The sensing voltage is abnormal. Make sure the cable is properly connected to the sensing input terminal.
57	Sync Frequency Error	Output Off	The frequency went out of the synchronizable range, and thus the output turned off.
58	Current Limiter [RMS]	Output Off	The RMS current limiter was activated, and thus the output was turned off according to the setting.
59	Current Limiter [Peak]	Output Off	The peak current limiter was activated, and thus the output was turned off according to the setting.
60	Power Unit Internal Error	Output Off	This is a power unit internal error. If it occurs repeatedly, contact the seller (NF Corporation or our agent) from whom you purchased the product.
61		Limiting action	The active wattage limiter is activated.
62		Limiting action	The RMS current limiter is activated.
63		Limiting action	The peak current limiter is activated. The internal operation differs from that for ID 64.
64		Limiting action	The peak current limiter is activated. The internal operation differs from that for ID 63.
68	PU-ON Setting Updated	Message display only	The power unit energization setting was updated.

Table 8-2 Error Message List (Continued)

ID	Message	Protection type	Cause or Necessary action
69	Polyphase Connection Updated	Message display only	A phase configuration is detected that is different from the previous one.
70, 71		Icon display	The power unit or the system has not been adjusted.
75	Calibration Data Error SH	Message display only	The adjustment data is abnormal.
77	USB Memory Connected	Message display only	A USB memory was inserted.
78	USB Memory Disconnected	Message display only	The USB memory eject operation was performed, and thus the USB memory can be removed now.
82	Sequence Compile Error	Message display only	Sequence compilation failed.
83	Simulation Compile Error	Message display only	Simulation compilation failed.
84	System Updated Please Reboot	System Lock	The firmware was updated.
85	System Updated Please Reboot	System Lock	The firmware was updated.
87	Unbalanced Line Voltage	System Lock	In the polyphase system, there is a cabinet with a different power supply voltage. Use the same power supply voltage.
-200	EXECUTION ERROR	Message display only	The panel operation (or remote command) could not be executed.

8.2 When a Failure is Suspected

When a symptom occurs that suspects a failure, take an action according to Table 8-3. If it does not solve the problem, contact the seller (NF Corporation or our agent) from whom you purchased the product.

Table 8-3 Actions When a Failure is Suspected

Category	Symptom	Possible Cause	Necessary Actions
Problem at power on/off	The product does not start operating when the power switch is turned on.	The power is not connected.	Connect the product to the power supply. →2.4
		The power supply is out of the rated range.	Use the power supply within the rated range. →2.4
		The internal fuse is blown.	Ask us or our agent for repair.
	The product does not stop immediately when the power switch is turned off.	It is not abnormal. The product automatically stops after the internal voltage decreases to a sufficiently safe level.	Please wait for a moment. It will stop in about five seconds.
	LCD shows nothing (fan is rotating).	The LCD contrast is low. The ambient temperature may be changed from the time when the contrast was adjusted.	Increase the LCD contrast. If the LCD display is completely invisible, perform the Shortcut operation (SHIFT) + (9) to adjust the contrast. Then, the digit cursor is placed on the tenths place. →4.27
Problem at key operation	Panel operations cannot be performed.	The key lock is set to on.	Set the key lock to off. →4.25
		Keys or dials are deteriorated.	Ask us or our agent for repair.
	Numerical values cannot be entered through the numeric keypad.	It is in the shift state (the SHIFT key LED illuminates).	Press the SHIFT key to exit from the shift state. →3.3.7
Problem at output setting	At start-up, the previous settings are not kept.	They are not saved in the setting memory No. 1.	At start-up, the settings in the setting memory No. 1 are recalled. →4.8.1
	The output voltage range cannot be switched.	The output is on.	Turn the output off before switching the output voltage range. →3.4.2
	The output voltage cannot be set.	The signal source is set to EXT or VCA.	Change the signal source. →3.4.1
		You are trying to set a value that is out of the setting range.	Check for the voltage setting range limit (see 4.1.3).
	The output frequency cannot be set.	The signal source is set to EXT or SYNC.	This value cannot be set when the signal source is EXT and SYNC. Change the signal source. →3.4.1
		You are trying to set a value that is out of the setting range.	Check for the frequency setting range limit (see 4.1.4).

Table 8-3 Actions When a Failure is Suspected (Continued)

Category	Symptom	Possible Cause	Necessary Actions
Problem at output setting	The line synchronization cannot be set.	The signal source is not set to SYNC.	Set the signal source to SYNC and the external synchronization signal source to LINE. →4.19
	The output on state cannot be achieved.	An error message is on-screen.	The output cannot be turned on while there is an error message. If the protection function is activated, remove the cause (see 8.1.2). Press the ENTER key to clear the error message. When the message says "System Locked", cycle the power.
Output-related problem	The output voltage does not come up.	The state is the output off (the OUTPUT key LED illuminates)	Press the OUTPUT key to turn the output on.
		The output voltage is set to zero.	Check for the output voltage setting. →3.4.4, 3.4.5
		The external signal source is not connected.	When the signal source is EXT, ADD, or VCA, connect the signal source to the external signal input terminal, and set the external input gain appropriately. →4.17, 4.20
		The external input gain is zero.	
	There is no output from the outlet on the front.	The output coupling mode is the DC mode.	The front output outlet can be used only in the AC mode or ACDC mode. The output does not appear in the DC mode.
		The output voltage range is 200 V.	The Japan/North America type outlet can be used only in the 100 V range. The output does not appear in the 200 V range.
	When the external signal is amplified on EXT or ADD, the waveform is distorted and the intended output is not provided.	The output coupling mode is the AC mode.	In the AC mode, the waveform may be distorted as the DC component removal function works. Use in the ACDC mode.
	The measured voltage is different from the setting value.	Unnecessary items are set (for example, the AC voltage setting remains for the DC output).	Check for the setting again. In the ADD mode, check on the external input signal and gain setting as well. →4.20
The limiter is activated (the limiter icon is displayed).		For a load with lower impedance, the limiter is activated to make the output lower than the setting value. Check on the limiter setting. →4.1	

Table 8-3 Actions When a Failure is Suspected (Continued)

Category	Symptom	Possible Cause	Necessary Actions
Output-related problem	The measured voltage is different from the setting value.	The waveform is set to CLP (clipped sine wave) and the Type is set to Clip (specified clip ratio mode).	In the specified clip ratio mode, the output voltage setting means a value for the waveform before being clipped. To set a value for the clipped waveform, set the Type to the specified crest factor mode (Type: CF). →4.6
	An error message is displayed.	The protection function was activated due to overload.	Connect a load within the maximum output range or decrease the output voltage setting.
		Excessive signal level of the signal generator.	When the signal source is EXT or ADD, lower the level of the connected signal generator or decrease the external input gain.
		The ambient temperature is high.	Decrease the ambient temperature when using the product. The maximum current may decrease over 40°C.
		Air filters are clogged.	Clean the air filters by referring to 9.2.
		Around the front panel air inlet or rear panel air outlet, there is something blocking the air flow.	Install the product so as to satisfy the installation conditions described in 2.2.
Measurement function-related problem	The measured voltage or current is not displayed correctly.	The display selection is not right.	Select RMS for AC. Otherwise, the correct value is not displayed.
	The measured value is displayed as "----".	It is out of the synchronization frequency measurement display range.	Set the synchronization signal source frequency to a value within the synchronization frequency measurement display range. →10.11
	The measured value fluctuates.	The signal source is set to EXT.	In EXT, the measurement cycle is fixed, and thus the difference from the external signal cycle may fluctuate the measured value. On the other hand, in the ADD mode, the appropriate measurement cycle is decided according to the internal signal source frequency setting. Therefore, if you know the frequency of the external signal to use, change the signal source to ADD, set the internal signal source frequency to the external signal frequency, and set the internal signal source output voltage to zero. →4.20
		A low frequency (less than 10 Hz) is set.	For a frequency lower than 10 Hz, the measurement cycle is a fixed value and thus the measured value may not be stable.

Table 8-3 Actions When a Failure is Suspected (Continued)

Category	Symptom	Possible Cause	Necessary Actions
Limiter/setting range limitation-related problem	The output current peak-hold value (measured) is larger than the peak current limiter setting value.	The output current overshoot occurred for the limit value.	While the peak current limiter is activated, the overshoot may occur depending on the load. →4.1.1
Remote sensing problem	The Remote sensing function cannot be turned on.	The output mode is incorrect.	The Remote sensing function can be set to on in the AC-INT, AC-VCA, AC-SYNC, DC-INT, and DC-VCA modes. However, for the AC mode, it can be set to on only when the waveform is a sine wave. It is turned off when the Sequence or Simulation function is selected. →4.11
		The waveform setting is incorrect.	
		The mode is not the Continuous mode.	
Problem of AGC function	The AGC function cannot be turned on.	The output mode is incorrect.	The AGC function can be set to on in the AC-INT, AC-VCA, AC-SYNC, DC-INT, and DC-VCA modes. However, for the AC mode, it can be set to on only when the waveform is a sine wave. It is turned off when the Sequence or Simulation function is selected. →4.12
		The waveform setting is incorrect.	
		The mode is not the Continuous mode.	
		The Autocal function is on.	When the Autocal function is on, the AGC function cannot be used. Turn off the Autocal function. →4.13
Problem of Autocal function	The Autocal function cannot be turned on.	The output mode is incorrect.	The Autocal function can be set to on in the AC-INT, AC-VCA, AC-SYNC, DC-INT, and DC-VCA modes. However, for the AC mode, it can be set to on only when the waveform is a sine wave. It is turned off when the Sequence or Simulation function is selected. →4.13
		The waveform setting is incorrect.	
		The mode is not the Continuous mode.	
		The AGC function is on.	When the AGC function is on, the Autocal function cannot be used. Turn the AGC function off. →4.12
Problem of remote control	Refer to the Instruction Manual (Remote Control) available from our website or an optional Control Software CD-ROM.		
Problem of external control function	The product cannot be controlled by the external control function.	The external control function is disabled.	Enable the external control function. →4.18
		The Remote state is set by the communication interface.	The external control function is disabled in the Remote state.

Table 8-3 Actions When a Failure is Suspected (Continued)

Category	Symptom	Possible Cause	Necessary Actions
Problem of USB memory	Files in the USB memory do not appear on the screen.	USB eject operation was performed.	Perform the USB eject operation (see 4.9) again just in case, and remove the USB memory. Reconnect the USB memory and make sure the file names are displayed.
		One folder contains over 500 files.	Reduce the number of files in a folder to 500 or less.
		The format is illegal.	Use a FAT32-formatted USB memory.
Problem at driving an inductive load (e.g., transformer)	The current waveform is abnormal (e.g., asymmetrical or excessive) when the transformer is connected as the load and the AC voltage is output.	The output offset voltage (DC component) caused the load transformer core to reach the magnetic saturation.	In the AC mode, the control function works to eliminate the offset voltage (DC component). When the product is used in the ACDC mode, switch it to the AC mode (see 3.4.1). If it does not bring much improvement, adjust the DC offset (see 4.14).
	The output overvoltage error occurs for an inductive load (e.g., transformer).	An abrupt change in the output current generated a back electromotive force.	When the output is off or the peak current limiter is activated, the load current may change abruptly, which generates a back electromotive force to cause the output overvoltage error. To avoid the abrupt current change, reduce the setting value of the peak current limiter sufficiently for a smaller output current, or conversely set it to a sufficiently large value to disable the limiter to be activated, or sufficiently reduce the amplitude before turning off the output. →4.1.1
Memory function-related problem	The memory cannot be recalled.	The output is on.	The output on state does not allow the recall. Turn the output off.

Table 8-3 Actions When a Failure is Suspected (Continued)

Category	Symptom	Possible Cause	Necessary Actions
Sequence/ Simulation- related problem	The Sequence cannot be started.	The output is off.	Turn on the output, then start the sequence.
	The specified Step Time is exceeded.	The Stop Phase is enabled.	When the stop phase setting is active, the execution waits for the Step Time that was set pass, and keeps the output setting until it reaches the Stop Phase that was set, and then transitions to the next step. As the result, the actual step time is longer than the set Step Time. To move to the next step immediately after the Step Time, disable the Stop Phase. →4.2
Problem of polyphase system	The polyphase system is not recognized at start-up.	The System Cable is not connected properly.	Check the System Cable connection for any disconnected connector, and so on.

9. Maintenance

9.1	Preface.....	234
9.2	Daily Maintenance	234
9.3	Storage, Repackaging, Transportation.....	236
9.4	Checking Firmware Version	237

9.1 Preface

This chapter describes:

- daily maintenance
- cautions and storing for nonuse over a long period
- cautions and repackaging for transportation.
- checking firmware version

For the simple operation check, see 2.7.

9.2 Daily Maintenance

This product shall be installed in a location that satisfies the installation conditions (see 2.2).

■ When the panel or case is dirty

Wipe it with a soft cloth. If the dirt is heavy, wipe it with a cloth wrung out with diluted neutral detergent solution.

CAUTION

- Do not use solvents (thinners, benzene, etc.) or wipes. Otherwise, the surface may be altered or the coatings may be peeled off.
-

■ When the front grill air filters are dirty

A front grill is provided with air filters for removing dust or dirt from the intake air. Clogged air filters deteriorate the ventilation, resulting in excessive high temperature inside the product. This may activate the overheat protection, affecting the operation, or damage the internal parts, resulting in failure. Regularly check the air filters for dirt, about once a month. If air filters are found dirty, rinse with water to remove the dirt, dry completely, then remount them. You can optionally request additional air filters for replacement (see 7.6).

CAUTION

- Do not install the product in a place with a large amount of extremely fine dust (e.g., powders). The air filters may not fully work.
 - Do not install the product in a damp place prone to dew. The air filters are more likely to be clogged.
-

WARNING

- Before removing the air filters and the front grill, be sure to cut the power to the distribution board. Otherwise, an electric shock might occur.
-

The air filter can be removed by the steps described below.

1. Loosen the screw at the bottom of the front grill holder by turning it clockwise.



2. Flip up the control panel to its maximum angle.



3. The topmost front grill is fixed at the bottom left and right to the chassis, and hung at the top on the hook of the chassis. Hold the front grill at the bottom left and right sides, and pull it out toward you to release it. Move the front grill upward and toward you. Unhook and remove it as letting the control panel through it.

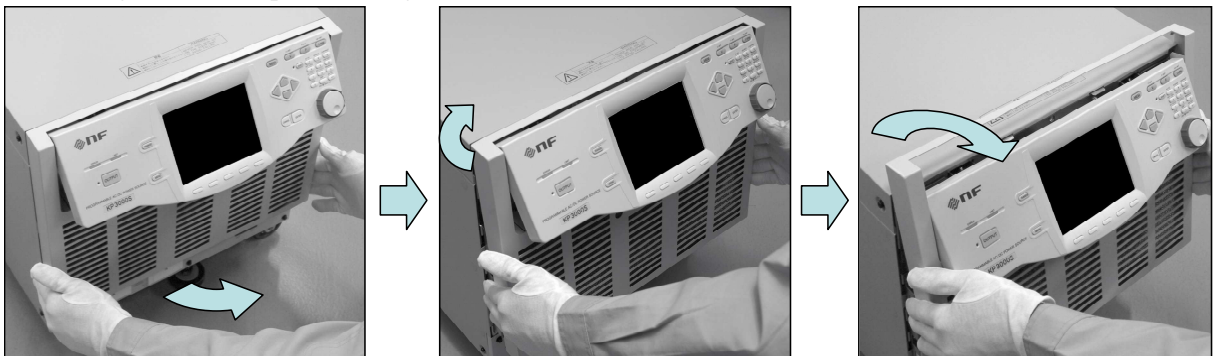

4. Remove the air filters from the back of each front grill. Be careful with the small claws on the front grill that hold the air filters.
5. Rinse the removed air filters with water to remove dirt and clog. Dry them completely.
6. Remount them in reverse order of steps 1 to 5.

⚠ WARNING

- While removing the air filters and the front grill, do not supply the power from the distribution board. Otherwise, an electric shock might occur.
-

9.3 Storage, Repackaging, Transportation

This product shall be stored in a location that satisfies the installation conditions (see 2.2).

■ Storage when unused for a long time

- Remove the power cable from the distribution board and the product.
- Store the product in a place with no falling object or dust. If it may be covered with dust, put the cover, such as cloth and polyethylene sheet, on it.
- Avoid a place exposed to rapid temperature change or direct sunlight. Store it under a normal temperature environment wherever possible. For the storage condition, see 10.31.

■ Repackaging and transportation

Follow the instructions below when repackaging the product due to transfer or repair.

- In order for the main unit to be sufficiently protected from impact during transportation, pack it with a shock absorber such as AirCap.
- When requesting transportation, instruct the carrier that this product is a precision instrument.
- Be sure to include the instruction manual at transportation.

9.4 Checking Firmware Version

■ Operation procedure

1. Press the MENU key to move to the root menu, then select [System]. The System menu opens.

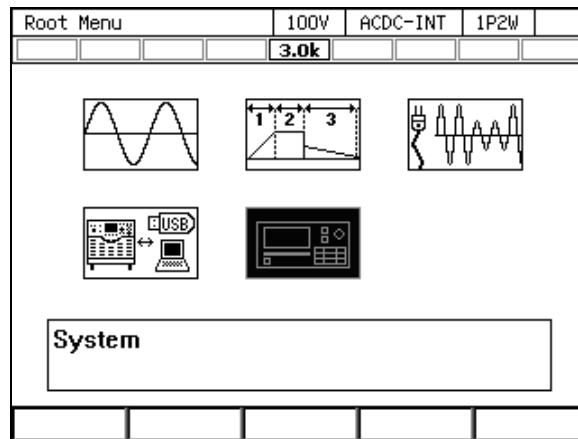

2. Put the cursor on [View] next to the [Information] item, then press the ENTER key.

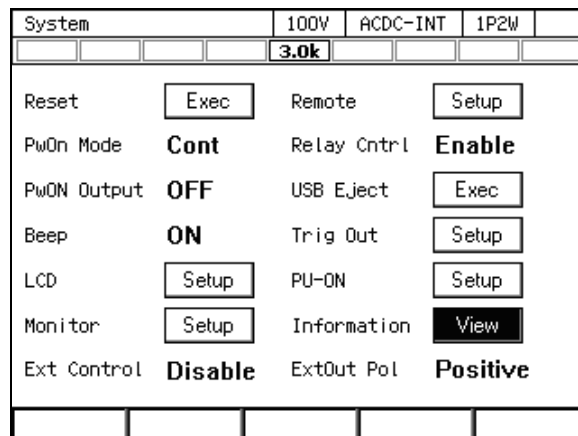

3. The Information window opens. The firmware version is shown at the [Firmware Version] item.

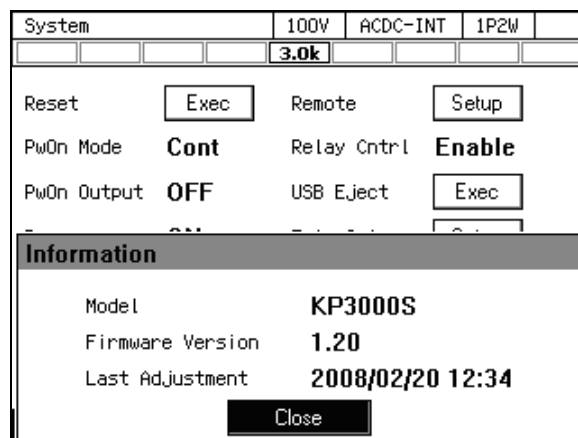

Note: This is a screenshot with firmware version 1.20.

10. Specifications

10.1	Output Function	241
10.2	Output Range	241
10.3	AC/DC Mode	241
10.4	Signal Source	242
10.5	AC Output	243
10.6	DC Output	245
10.7	Output Voltage Stability	245
10.8	Distortion of Output Voltage Waveform	245
10.9	Power Input	246
10.10	Withstand Voltage and Insulation Resistance	246
10.11	Measurement Function	246
10.12	Power Unit Energization Setting	248
10.13	Current Limiter	249
10.14	Setting Range Limit Function	250
10.15	Remote Sensing	251
10.16	AGC	251
10.17	Autocal (Output Voltage Compensation)	252
10.18	Sequence	253
10.19	Simulation	254
10.20	Clipped Sine Wave	255
10.21	Arbitrary Wave	255
10.22	External Signal Input	256
10.23	General Function	257
10.24	Memory Function	258
10.25	Self-diagnosis/Protection Function	259
10.26	External Control I/O	260
10.27	External Interface	261
10.28	USB Memory Interface	262
10.29	Waveform Monitor Output	262
10.30	Safety, EMC, and RoHS	262
10.31	Operation Environment	263
10.32	Externals, Weight, and Terminal Block	263
10.33	Option	264
10.34	Outline Dimensional Drawing	265

10. Specifications

Specifications are valid under the following settings and conditions and after a warm-up period of 30 minutes at least, unless otherwise noted.

Load	Resistance load of power factor 1
Signal source	INT (internal signal source)
Output voltage waveform	Sine wave
Remote sensing	Off
AGC/Autocal	Off
Current Limiter	Factory default setting
Output terminal	Output terminal block on the rear panel

[set] indicates a setting value, and [rdg] indicates a read value.

The description noted with "/" indicates that the specification changes by the output range, such as "100 V range specification/200 V range specification."

A value with the accuracy is the guaranteed value of the specification. However, an accuracy noted as reference value shows the supplemental data for reference when the product is used, and is not under the guarantee. A value without the accuracy is the nominal value or representative value (shown as typ.).

This product corresponds to Clause 2 (8) Frequency converter, Appendix 1 of Export Trade Control Ordinance. The permission for exportation of the Japanese Administration is necessary for export outside Japan.

Notes on Polyphase System

Single-phase three-wire (1P3W) system can be configured by connecting 2 models of the same type (output power capacity). Three-phase four-wire (3P4W) system can be configured by connecting 3 models in the same way. These are called as polyphase system.

Firmware discriminates power capacity and polyphase type at the start-up process just after turning on the system connected with an optional system cable (either 1P3W or 3P4W type), and the system starts to operate as that power capacity and polyphase type.

Output Lo terminals connected together become a neutral point (N terminal) in both the 1P3W and 3P4W system. Hi terminals are called L1, L2, and L3, respectively (L3 exists only in 3P4W system). The cabinet to which the L1 connector of the System Cable is connected operates as master. The cabinets to which L2 and L3 is connected operate as slave. Output voltage is defined with phase voltage (L1, L2, and L3 to N) in this document unless otherwise noted.

10.1 Output Function

KP3000S	
Output function	Continuous, Sequence, Simulation

10.2 Output Range

KP3000S	
Output range	100 V range, 200 V range

10.3 AC/DC Mode

KP3000S	
AC/DC mode	AC, AC+DC, DC

Description	
AC	<p>The signal source and amplification section of this product are AC-coupled, and the DC component is canceled.</p> <p>Only the AC output setting of 40 Hz or higher is available.</p> <p>The signal sources that can be combined are INT, VCA, SYNC, EXT, and ADD.</p> <p>When the waveform superimposed with DC is amplified using EXT and ADD (using external signal sources), it may not be an intended output because the DC component is canceled. In this case, select the AC+DC mode.</p>
AC+DC	<p>The signal source and amplification section of this product are DC-coupled, and the DC component is also amplified.</p> <p>The AC and DC output settings of 1 Hz or higher are available.</p> <p>The signal sources that can be combined are INT, SYNC, EXT, and ADD.</p> <p>In the polyphase system, only the AC setting is available.</p> <p>Fixed to this mode in the Simulation.</p> <p>Select this mode when you want to amplify a signal including DC, to superimpose DC (DC offset), or output a frequency of 40 Hz or lower. Also select this mode when the DC component temporally occurs, for example, by sudden change of voltage or phase.</p>
DC	<p>The signal source and amplification section of this product are DC-coupled.</p> <p>Only the DC setting is available.</p> <p>The signal sources that can be combined are INT and VCA.</p> <p>It is unavailable for the polyphase system.</p>

10.4 Signal Source

	KP3000S
Signal source	INT, VCA, SYNC, EXT, ADD

	Description
INT	<p>Uses the internal signal source.</p> <p>Sets the output voltage, output waveform, frequency, output on phase, and output off phase by using the panel or the external interface such as USB.</p> <p>Fixed to INT in the Sequence and Simulation.</p>
VCA	<p>Uses the internal signal source.</p> <p>Controls the output voltage setting of the internal signal source with the DC signal which is input to the external input terminal. The output voltage setting cannot be set from external interfaces such as the panel or USB. All conditions except for output voltage setting are same as INT.</p> <p>In the polyphase system, the setting is common to all the phases.</p> <p>Cannot be selected in the AC+DC mode.</p>
SYNC	<p>Uses the internal signal source.</p> <p>Synchronizes the frequency of the internal signal source with the signal (EXT) from the external synchronization signal input terminal (also used as the external input terminal) or the power supply input frequency (LINE) of the product. The frequency setting cannot be set from external interfaces such as the panel or USB. All conditions except for output frequency setting are same as INT.</p> <p>Cannot be selected in the DC mode.</p>
EXT	<p>Uses the external signal source.</p> <p>Amplifies the signal from the external input terminal by the specified gain (variable), and outputs it.</p> <p>Cannot be selected for the polyphase system.</p> <p>Cannot be selected in the DC mode.</p>
ADD	<p>Uses both the internal and external signal sources.</p> <p>Amplifies the signal from the external input terminal by the specified gain like EXT, and adds the internal signal source component to it.</p> <p>Cannot be selected for the polyphase system.</p> <p>Cannot be selected in the DC mode.</p>

10.5 AC Output

[V]=Vrms, [A]=Arms, and the power input voltage is 200 V, unless otherwise noted.

		KP3000S
Mode		Single-phase two-wire Floating output, the Lo terminal can be grounded.
Rated output voltage		100 V / 200 V
Voltage setting range		0.0 V to 155.0 V / 0.0 V to 310.0 V 0.0 Vp-p to 440.0 Vp-p / 0.0 Vp-p to 880.0 Vp-p (arbitrary wave)
Setting resolution		0.1 V
Voltage accuracy	*1	$\pm (0.5 \% \text{ of set} + 0.6 \text{ V} / 1.2 \text{ V})$
Maximum current	*2	30 A / 15 A
Maximum peak current	*3	Peak value (Apk) which is four times of the maximum current
Power capacity		3 kVA
Load power factor		0 to 1 (phase lead or phase lag, 45 Hz to 65 Hz, external power injection and regeneration are not available.)
Frequency setting range		40.00 Hz to 550.00 Hz (AC mode) 1.00 Hz to 550.00 Hz (AC+DC mode)
Setting resolution		0.01 Hz
Frequency accuracy		$\pm 0.01 \% \text{ of set} (23 \text{ }^\circ\text{C} \pm 5 \text{ }^\circ\text{C})$
Frequency stability	*4	$\pm 0.005 \%$
Voltage frequency characteristic	*5	$\pm 1 \%$
Output waveform		sine wave, arbitrary wave (16 types), clipped sine wave (3 types)
Output on phase setting range		0.0° to 359.9° variable
Setting resolution		0.1°
Output off phase setting range		0.0° to 359.9° variable (active/inactive selectable)
Setting resolution		0.1°
DC offset	*6	Within $\pm 20 \text{ mV}$ (typ., fine adjustment available)

*1: In the case of 10 V to 150 V / 20 V to 300 V, sine wave, no load, 45 Hz to 65 Hz, DC voltage setting 0 V, 23 °C \pm 5 °C.

*2: If the output voltage is higher than the rated value, this is limited (lowered) to satisfy the power capacity. If there is the DC superimposition, the active current of AC+DC satisfies the maximum current. In the case of 40 Hz or lower, or 400 Hz or higher, and that the ambient temperature is 40 °C or higher, the maximum current may decrease.

*3: For the capacitor input type rectified load (crest factor=4), the rated output voltage, and 45 Hz to 65 Hz.

*4: For 45 Hz to 65 Hz, the rated output voltage, no load and the resistance load for the maximum current, and the operating temperature.

*5: For 40 Hz to 550 Hz, sine wave, the rated output voltage, the resistance load for the maximum current at 55 Hz, and 55 Hz reference.

*6: In the case of the AC mode and 23 °C \pm 5 °C.

10. Specifications

[V]=Vrms, [A]=Arms, and the power input voltage is 200 V, unless otherwise noted.

		Polyphase system	
Mode		Single-phase three-wire	Three-phase four-wire (Y-connection)
		Floating output (Connect Lo terminals to each other), the Lo terminal can be grounded.	
Setting mode		Balanced mode, Unbalanced mode	
Rated output voltage (Phase voltage)		100 V / 200 V	
Voltage setting range		Phase voltage setting (for all phases in balanced mode and each phase in unbalanced mode) 0.0 V to 155.0 V / 0.0 V to 310.0 V 0.0 Vp-p to 440.0 Vp-p / 0.0 Vp-p to 880.0 Vp-p (arbitrary wave)	
		Line voltage setting (balanced mode and sine wave only) 0.0 V to 310.0 V / 0.0 V to 620.0 V 0.0 V to 310.0 V / 0.0 V to 620.0 V	
	Setting resolution	Phase voltage setting: 0.1 V, Line voltage setting: 0.2 V	
Voltage accuracy (Phase voltage)	*7	$\pm (0.5 \% \text{ of set} + 0.6 \text{ V} / 1.2 \text{ V})$	
Maximum current	*8	30 A / 15 A	
Maximum peak current	*9	Peak value (Apk) which is four times of the maximum current	
Power capacity		6 kVA	9 kVA
Load power factor		0 to 1 (phase lead or phase lag, 45 Hz to 65 Hz, external power injection and regeneration are not available.)	
Frequency setting range		40.00 Hz to 550.00 Hz (AC mode) 1.00 Hz to 550.00 Hz (AC+DC mode)	
	Setting resolution	0.01 Hz	
Frequency accuracy		$\pm 0.01 \% \text{ of set} (23 \text{ }^\circ\text{C} \pm 5 \text{ }^\circ\text{C})$	
Frequency stability	*10	$\pm 0.005 \%$	
Voltage frequency characteristic	*11	$\pm 1 \%$	
Output waveform		sine wave, arbitrary wave (16 types), clipped sine wave (3 types)	
Output on phase setting range	*12	0.0° to 359.9° variable	
	Setting resolution	0.1°	
Output off phase setting range	*12	0.0° to 359.9° variable (active/inactive selectable)	
	Setting resolution	0.1°	
Phase angle setting range (Unbalanced mode)		L2 phase: 0° to 359.9°	L2 phase: 0° to 359.9° L3 phase: 0° to 359.9°
	Setting resolution	0.1°	
Phase angle accuracy	*13	45 Hz to 65 Hz: $\pm 1.0^\circ$ 40 Hz to 550 Hz: $\pm 2.0^\circ$	
	DC offset	*14	Within $\pm 20 \text{ mV}$ (typ., fine adjustment available)

*7: In the case of 10 V to 150 V / 20 V to 300 V, sine wave, no load, 45 Hz to 65 Hz, 23 °C \pm 5 °C.

*8: If the output voltage is higher than the rated value, this is limited (lowered) to satisfy the power capacity. In the case of 40 Hz or lower or 400 Hz or higher, and that the ambient temperature is 40 °C or higher, the maximum current may decrease.

*9: For the capacitor input type rectified load (crest factor=4), the rated output voltage, and 45 Hz to 65 Hz.

*10: For 45 Hz to 65 Hz, the rated output voltage, no load and the resistance load for the maximum current, and the operating temperature.

*11: For 40 Hz to 550 Hz, sine wave, the rated output voltage, the resistance load for the maximum current at 55 Hz, and 55 Hz reference.

*12: Set for the L1 phase. The component of the phase angle setting is added for the other phases.

*13: In the case of 50 V or higher, sine wave, and same load condition and voltage setting for all phases.

*14: In the case of the AC mode and 23 °C \pm 5 °C.

10.6 DC Output

[V]=Vdc, [A]=Adc, the power input voltage is 200 V, and the polarity is relative to the Lo terminal, unless otherwise noted.

KP3000S	
Mode	Floating output, the Lo terminal can be grounded.
Rated output voltage	100 V / 200 V
Voltage setting range	-220.0 V to +220.0 V / -440.0 V to +440.0 V
Setting resolution	0.1 V
Voltage accuracy *15	$\pm (0.5 \% \text{ of set} + 0.6 \text{ V} / 1.2 \text{ V})$
Maximum current *16	30 A / 15 A
Maximum instantaneous current *17	Peak value (Apk) which is four times of the maximum current
Power capacity	3 kW

*15: In the case of -212 V to -10 V, +10 V to +212 V / -424 V to -20 V, +20 V to +424 V, no load, AC setting 0 V, 23 °C \pm 5 °C.

*16: If the output voltage is higher than the rated value, this is limited (lowered) to satisfy the power capacity. If there is the AC superimposition, the active current of DC+AC satisfies the maximum current. In the case that the ambient temperature is 40 °C or higher, the maximum current may decrease.

*17: Instantaneous = within 2 ms, at the rated output voltage.

10.7 Output Voltage Stability

KP3000S	
Fluctuation with input voltage *18	Within $\pm 0.15 \%$
Fluctuation with output current *19	DC Within $\pm 0.15 \text{ V} / \pm 0.30 \text{ V}$ 45 Hz to 65 Hz Within $\pm 0.15 \text{ V} / \pm 0.30 \text{ V}$ 40 Hz to 550 Hz Within $\pm 0.5 \text{ V} / \pm 1.0 \text{ V}$
Fluctuation with ambient temperature *20	Within $\pm 0.01 \%$ /°C (typ.)

*18: For power input 90 V to 250 V, power input 200 V reference, the resistance load at the maximum current, the rated output voltage, DC or 45 Hz to 65 Hz. Transition state immediately after a change of the input power-supply voltage is not included. For the polyphase system, it is a specification for phase voltage setting.

*19: In the case that the output current is changed from 0 % to 100 % of the maximum current. For output voltage 75 V to 150 V/150 V to 300 V, no load reference. However, if the output voltage is higher than the rated value, the maximum current is limited to satisfy the power capacity. For the polyphase system, it is a specification for phase voltage setting.

*20: For power input 200 V, no load, the rated output voltage, DC or 45 Hz to 65 Hz. For the polyphase system, it is a specification for phase voltage setting.

10.8 Distortion of Output Voltage Waveform

KP3000S	
Distortion *21	0.5 % or lower

*21: 40 Hz to 550 Hz, 50 % or higher of the rated output voltage, the maximum current or lower, AC and AC+DC modes, THD+N. For the polyphase system, it is a specification for phase voltage setting.

10.9 Power Input

		KP3000S
Voltage		100 V to 230 V $\pm 10\%$ (250 V or lower), Overvoltage Category II
Frequency		50 Hz ± 2 Hz or 60 Hz ± 2 Hz
Phase		Single-phase
Power factor		Power input 100 V: 0.95 or higher (typ.) Power input 200 V: 0.90 or higher (typ.)
Efficiency	*22	77 % or higher (typ. power input voltage 200 V)
Maximum power consumption		4.5 kVA or lower

*22: In the case of AC- INT, the rated output voltage, the resistance load at the maximum current, 45 Hz to 65 Hz output.

10.10 Withstand Voltage and Insulation Resistance

Power input - Output/Chassis and Power input/Chassis - Output

		KP3000S
Withstand voltage		AC 1500 V or DC 2130 V, 1 minute.
Insulation resistance		30 M Ω or higher (DC 500 V)

10.11 Measurement Function

All accuracy of the measurement function is indicated for 23 °C ± 5 °C.

View

		KP3000S
Normal		Displays almost all the measured and setting values excluding the harmonic current measurement on one screen.
Simple		Enlarges and displays three items among all the measured values except the harmonic current measurement.

Voltage *23

		KP3000S
Effective value (rms)	Full scale	250.0 V / 500.0 V
	Resolution	0.1 V
	Accuracy	DC, 45 Hz to 65 Hz $\pm (0.5\% \text{ of rdg} + 0.3 \text{ V} / 0.6 \text{ V})$ 40 Hz to 550 Hz $\pm (0.7\% \text{ of rdg} + 0.9 \text{ V} / 1.8 \text{ V})$
DC average value (avg)	Full scale	$\pm 250.0 \text{ V} / \pm 500.0 \text{ V}$
	Resolution	0.1 V
	Accuracy	DC $\pm (0.5\% \text{ of rdg} + 0.3 \text{ V} / 0.6 \text{ V})$
Peak value (pk) (each of max and min)	Full scale	$\pm 250.0 \text{ V} / \pm 500.0 \text{ V}$
	Resolution	0.1 V
	Accuracy *24	DC, 45 Hz to 65 Hz $\pm (2\% \text{ of rdg} + 1 \text{ V} / 2 \text{ V})$

*23: The accuracy values are in the case that the output voltage is within voltage setting range. In the polyphase system, this specification is for the phase voltage and the DC average value display cannot be selected.

*24: The accuracy of the peak value is for a waveform of DC or sine wave.

Voltage (Line voltage. Only with the polyphase system. Only with the sine waveform output.)

		KP3000S polyphase system
Effective value (rms)	Full scale	1P3W: 500.0 V / 1000.0 V 3P4W: 433.0 V / 866.0 V
	*25 Resolution	0.1 V

*25: The displayed value is the result of calculation with the phase voltage measured value and the phase angle setting value regarding the output voltage waveform as a sine wave.

Current (phase current) *26 *27

		KP3000S
Effective value (rms)	Full scale	40 A / 20 A
	Resolution	0.01 A
	Accuracy	DC, 45 Hz to 65 Hz $\pm (0.5 \% \text{ of rdg} + 0.08 \text{ A} / 0.04 \text{ A})$ 40 Hz to 550 Hz $\pm (0.7 \% \text{ of rdg} + 0.08 \text{ A} / 0.04 \text{ A})$
DC average value (avg)	Full scale	$\pm 40 \text{ A} / \pm 20 \text{ A}$
	Resolution	0.01 A
	Accuracy	DC $\pm (0.5 \% \text{ of rdg} + 0.08 \text{ A} / 0.04 \text{ A})$
Peak value (pk) (each of max and min)	Full scale	$\pm 160 \text{ A} / \pm 80 \text{ A}$
	Resolution	0.01 A
	Accuracy (Reference value) *28	DC, 45 Hz to 65 Hz $\pm (2 \% \text{ of rdg} + 0.4 \text{ A} / 0.2 \text{ A})$
	Hold	Holds the maximum values of max and min with the polarity (with the clear function)

*26: The accuracy values are in the case that the output current is 5 % to 100 % of the maximum current.

*27: In the polyphase system, these are the specifications for the phase current. The DC average value display cannot be selected.

*28: The accuracy of the peak value is for a waveform of DC or sine wave.

Power *29 *30 *31 *32

		KP3000S
Active (W)	Full scale	3600 W
	Resolution	0.1 W/1 W (1000 W or higher)
	Accuracy *33	DC, 45 Hz to 65 Hz $\pm (1 \% \text{ of rdg} + 1.5 \text{ W})$
Apparent (VA)	Full scale	4500 VA
	Resolution	0.1 VA/1 VA (1000 VA or higher)
	Accuracy	45 Hz to 65 Hz $\pm (2 \% \text{ of rdg} + 3 \text{ VA})$
Reactive (var)	Full scale	4500 var
	Resolution	0.1 var/1 var (1000 var or higher)
	Accuracy *34	45 Hz to 65 Hz $\pm (2 \% \text{ of rdg} + 3 \text{ var})$

*29: All in the case of sine wave, 50 V or higher output voltage, and that the output current is 10 % or higher of the maximum current.

*30: In the polyphase system, these are the specifications for each phase.

*31: In the polyphase system, the all-phase total display is available.

*32: The apparent and reactive powers are not displayed in the DC mode.

*33: The active power is for the load with the power factor 1. In the case of the load with the power factor 0.5 to lower than 1, the accuracy is twice the value with the power factor 1.

*34: The reactive power is for the load with the power factor 0.5 or lower.

10. Specifications

Load power factor, Load crest factor

		KP3000S
Power factor *35	Measurement range	0.00 to 1.00
	Resolution	0.01
Crest factor	Measurement range	0.00 to 50.00
	Resolution	0.01

*35: The power factor is not displayed in the DC mode.

Synchronization frequency (only SYNC)

		KP3000S
Display range		38.0 Hz to 525.0 Hz
Resolution		0.1 Hz
Accuracy		±0.2 Hz

Harmonic current (AC-INT, fundamental wave 50 Hz/60 Hz only, phase current) *36

		KP3000S
Measurement range		Up to 40th order of the fundamental wave
Full scale		40 A / 20A, 100 %
Resolution		0.01 A, 0.1 %
Accuracy (at RMS, reference value)	Up to 20th	± (1 % of rdg + 0.4 A / 0.2 A)
	21st to 40th	± (1.5 % of rdg + 0.4 A / 0.2 A)

*36: The measurement does not conform to the IEC or other standard.

Display of emission CO₂

		KP3000S
Displayed items		Displays the instantaneous (kgCO ₂ /h) and integration (tCO ₂ , can be cleared) values for the internal loss and the output power
Full scale		Instantaneous: 20 kgCO ₂ /h, Integration: 2000 tCO ₂
Resolution		Instantaneous: 0.001 kgCO ₂ /h, Integration: 0.000001 tCO ₂
Emission CO ₂ coefficient		Variable (resolution 0.000001 tCO ₂ /kWh) Factory default: 0.000555 tCO ₂ /kWh

10.12 Power Unit Energization Setting

The power consumption can be decreased by decreasing the number of the power units in operation according to the load capacity. Each power unit can be enabled (energized)/disabled (not energized) separately. (1.5 kVA or 1.5 kW/power unit)

		KP3000S
Number of units		2

10.13 Current Limiter

This controls the output voltage for the output current to be within the limiter setting value when the peak value or RMS exceeds it. The output can be configured to be turned off when the limited state continues over the specified time.

In the polyphase system, the settings are made for the phase current and common to all the phases.

Peak current limiter

		KP3000S
Positive current	Setting Range (Peak value) *37	+15.0 A to +126.0 A / +7.5 A to +63.0 A
	Factory default *38	+126.0 A / +63.0 A
Negative current	Setting Range (Peak value) *37	-126.0 A to -15.0 A / -63.0 A to -7.5 A
	Factory default *38	-126.0 A / -63.0 A
Resolution		0.1 A
Limiter operation		Select whether to recover automatically (continuous) or turn the output off when the limited state continues over the specified time (1 s to 10 s, resolution 1 s). Factory default setting is output OFF when the limit state continues for 10 s.

*37: When you set the number of units by the power unit energization setting to 1, the setting range becomes half.

*38: If you increased or decreased the number of units by the power unit energization setting, the factory default setting corresponding to the capacity is used.

RMS current limiter

		KP3000S
Setting range (effective value) *39		1.5 A to 31.5 A / 1.5 A to 15.8 A
Factory default *40		31.5 A / 15.8 A
Resolution		0.1 A
Limiter operation		Select whether to recover automatically (continuous) or turn the output off when the limited state continues over the specified time (1 s to 10 s, resolution 1 s). Factory default setting is output OFF when the limit state continues for 10 s.

*39: When you set the number of units by the power unit energization setting to 1, the setting range becomes half.

*40: If you increased or decreased the number of units by the power unit energization setting, the factory default setting corresponding to the capacity is used.

10.14 Setting Range Limit Function

This is the limit function for the setting of the internal signal source. It works when the signal source is INT, VCA (frequency setting limit only), SYNC (voltage setting limit only), or ADD (internal signal source only). The limitation does not work for the Sequence and Simulation. It does not also work for the external signal source of EXT and ADD.

In the polyphase system, the setting is common to all the phases.

Voltage setting limit 1 (in the AC mode, and sine wave or clipped sine wave is selected)

KP3000S	
Setting range (effective value) *41	Phase voltage setting 0.1 V to 155.0 V / 0.1 V to 310.0 V
	Line voltage setting (single-phase three-wire) 0.2 V to 310.0 V / 0.2 V to 620.0 V
	Line voltage setting (three-phase four-wire) 0.2 V to 268.4 V / 0.2 V to 536.8 V
Factory default	Phase voltage setting, 155.0 V / 310.0 V
Resolution	Phase voltage setting: 0.1 V, line voltage setting: 0.2 V

*41: The line voltage setting is available only when the output voltage setting is set as the line voltage and sine wave is selected in the balanced mode of the polyphase system.

Voltage setting limit 2 (other than Voltage setting limit 1, phase voltage setting only) *42

KP3000S		
Positive voltage	Setting Range (Peak value)	+0.1 V to +220.0 V / +0.1 V to +440.0 V
	Factory default	+220.0 V / +440.0 V
Negative voltage	Setting Range (Peak value)	-220.0 V to -0.1 V to -440.0 V to -0.1 V
	Factory default	-220.0 V / -440.0 V
Resolution		0.1 V

*42: The limitation is applied to the additional values of the AC voltage setting (recalculated to a peak value) and the DC voltage setting.

Frequency setting limit (the lower limit \leq the upper limit) *43

KP3000S		
Upper limit	Setting Range	1.00 Hz (AC mode : 40.00 Hz) to 550.00 Hz
	Factory default	550.00 Hz
Lower limit	Setting Range	1.00 Hz (AC mode : 40.00 Hz) to 550.00 Hz
	Factory default	1.00 Hz (AC mode : 40.00 Hz)
Resolution		0.01 Hz

*43: In the AC mode, the setting range is 40.00 Hz to 550.00 Hz.

10.15 Remote Sensing

This switches the voltage used for measurement. When the remote sensing is on, the sensing input terminal voltage is used. When it is off, the output terminal voltage is used.

By combining with AGC or Autocal, a voltage drop due to wiring to the load can be compensated. When the remote sensing is on, the output voltage detection point corrected by the AGC or Autocal function is switched to the sensing input terminal. When AGC or Autocal is off, only the detection voltage used for measurement display is switched.

Effective only for AC-INT, AC-VCA, AC-SYNC, DC-INT, and DC-VCA and when the waveform is sine wave or DC. It is turned off when the Sequence or Simulation is selected.

	Measurement voltage, power, power factor	AGC/Autocal	
		Off	On
On	Use the sensing input terminal voltage	Not active	Active
Off	Use the output terminal voltage	Not active (factory default)	Active

10.16 AGC

When the AGC (Automatic Gain Control) is on, the detection point voltage is always measured, and the output voltage is continuously corrected so that its effective value is equal to the output voltage setting value. The fluctuation of the detection point voltage can be suppressed even when the load is fluctuated. The detection point can be switched between the sensing input terminal (remote sensing on) and the output terminal (remote sensing off).

Effective only for AC-INT, AC-VCA, AC-SYNC, DC-INT, and DC-VCA and when the waveform is sine wave or DC. It is turned off when the Sequence or Simulation is selected. It cannot be selected when the Autocal is set to on.

KP3000S	
Response time	Within 100 ms (typ.) (DC/50 Hz/60 Hz, at the rated output voltage)
Operation range	The output voltage setting is 8 V or higher
Calibration range	Within $\pm 10\%$ (difference between the output voltage and measured value) The output voltage should be within the allowed voltage setting range of the product.
Accuracy	Within $\pm 0.5\text{ V} / \pm 1.0\text{ V}$ (in the case of DC or 40 Hz to 550 Hz, 50 V or higher output voltage, resistance load, the output current is the maximum current or less)

10.17 Autocal (Output Voltage Compensation)

When the Autocal (Automatic Calibration) is on, the detection point voltage is always measured, and the output voltage is continuously corrected so that its effective value is equal to the output voltage setting value. The ratio (correction factor) of the detection point voltage to the output voltage setting value is used until the Autocal or the power is turned off. Therefore, the detection point voltage is not necessarily maintained if the load changes while the Autocal is on. The detection point can be switched between the sensing input terminal (remote sensing on) and the output terminal (remote sensing off).

Unlike the AGC, it cannot follow a load fluctuation because it does not keep track of the voltage. On the other hand, when the load is stable, it has a merit of short response time on changing the output voltage setting.

Effective only for AC-INT, AC-VCA, AC-SYNC, DC-INT, and DC-VCA and when the waveform is sine wave or DC. It is turned off when the Sequence or Simulation is selected. It cannot be selected when the AGC is set to on.

KP3000S	
Restriction when on	The output voltage setting is 8 V or higher
Calibration range *44	Within $\pm 10\%$ (difference between the output voltage and measured value) The output voltage should be within the allowed voltage setting range of the product.
Accuracy *44	Within $\pm 0.5\text{ V} / \pm 1.0\text{ V}$ (in the case of DC or 40 Hz to 550 Hz, 50 V or higher output voltage, resistance load, the output current is the maximum current or less)

*44: The values of the calibration range and accuracy are the ones at the time when the Autocal is turned on.

10.18 Sequence

Effective only for AC-INT, AC+DC-INT, and DC-INT.

KP3000S	
Number of memories	5 (non-volatile)
Number of steps	Maximum 255 (for each sequence)
Setting range of Step Time	0.0010 s to 999.9999 s
Intra-Step behavior	Constant, Keep, Linear Sweep
Parameter *45 *46 *47	Output range AC/DC mode (The signal source is fixed to INT) (The above 2 items are common within one sequence) AC voltage, frequency, waveform DC voltage Start Phase Stop Phase Phase angle Step termination Jump count (1 to 9999, or infinite) Specification of the Jump-to step Synchronous step output (2 bit) Specification of the branch step Trigger output
Sequence control	Start Stop Hold Resume Branch 1, Branch 2

*45: For DC-INT, the AC voltage, frequency, waveform, Start Phase, and Stop Phase cannot be set.

*46: The DC voltage cannot be set when the polyphase system is configured.

*47: The Phase angle can be set only in the polyphase system. The Start Phase and Stop Phase are specified for the L1 phase, and the component of the Phase angle setting is added to them for the other phases.

10.19 Simulation

This allows you to simulate power line abnormalities, such as blackout, voltage rise, voltage drop, abrupt phase change, and abrupt frequency change. It can be used only for AC, sine wave, and AC+DC-INT. Note that it does not support IEC or other standards test. In the polyphase system, only the balanced mode is available.

KP3000S	
Number of memories	5 (non-volatile)
Number of steps	6 (Initial, Normal 1, Trans 1, Abnormal, Trans 2, Normal 2)
Setting range of Step Time	0.0010 s to 999.9999 s (0 s is available only for the Transition Step)
Parameter	<p>Output range (The above item is common within the Simulation)</p> <p>AC voltage Frequency Waveform (sine wave only) Start Phase (excluding the Transition Step) Stop Phase (excluding the Transition Step) Synchronous step output (2 bit) Trigger output Repeat count (1 to 9999 times or infinite)</p>
Simulation control	Start Stop

10.20 Clipped Sine Wave

The peak clipped sine wave can be output, based on the crest factor (CF) setting or the percent setting to the peak value.

		KP3000S
Number of memories		3 (non-volatile)
CF *48 *49	Variable range	1.10 to 1.41
	Factory default	1.41
	Setting resolution	0.01
	Effective value correction	Yes
Clip ratio *48 *50	Variable range	40.0 % to 100.0 %
	Factory default	100.0 %
	Setting resolution	0.1 %
	Effective value correction	None

*48: In the polyphase system, these are the settings for the phase voltage.

*49: The crest factor is represented as "voltage peak value/voltage effective value." It is 1.41 for sine wave.

*50: When the clip ratio is specified, the peak is clipped by the voltage corresponding to the specified % to the peak value of the setting voltage (100 %).

Example) For the output voltage setting of 100 Vrms and the clip rate of 80 %, the peak is clipped at 113.1 Vpk.

10.21 Arbitrary Wave

This uses the waveform data saved in the internal memory, which is transferred and recalled using the external interface or USB memory.

		KP3000S
Number of memories	16 (non-volatile)	
Waveform length	4096 words	
Amplitude resolution	16 bit	

10.22 External Signal Input

The external signal input works differently depending on the selection of the signal source.

10.22.1 External Synchronous Signal Input (Signal Source SYNC only)

This is the signal to synchronize the frequency of the internal signal source with the one of the external signal source.

When the signal source is SYNC, you can select whether to synchronize with this external signal input or the power input frequency of the product. When synchronizing with the power input frequency, no signal input is needed.

	KP3000S	Factory default
Synchronization signal source switch	External synchronization signal (EXT) or Power input (LINE)	LINE
Synchronization frequency range	40 Hz to 500 Hz	
Input terminal	BNC connector (rear panel, unbalanced)	
Input impedance	1 MΩ	
Threshold of input voltage	TTL level	
Minimum pulse width	500 μs	
Nondestructive maximum input voltage	±10 V	

10.22.2 Voltage Setting Signal Input (Signal Source VCA only)

This is the signal to set the output voltage amplitude of the internal signal source (DC input).

Output voltage (Vpk) = Voltage setting signal (Vdc) × Gain (Vpk/Vdc)

Example 1) For the AC mode, signal source = VCA, the gain of 100.0, and the voltage setting signal input of 1 Vdc, the output voltage is 100 Vpk.

Example 2) For the AC mode, signal source = VCA, the gain of 141.4, and the voltage setting signal input of 1 Vdc, the output voltage is 141.4 Vpk (=100 Vrms).

		KP3000S	Factory default
Gain setting range	*51	100 V range: 0.0 to 220.0 times 200 V range: 0.0 to 440.0 times	100 200
Setting resolution	*51	0.1	
Gain accuracy	*52	±5 %	
Input terminal		BNC connector (rear panel, unbalanced) Also used as the external synchronization signal input	
Input impedance		1 MΩ	
Input voltage range		±2.2 V (A/D resolution 10 bit)	
Nondestructive maximum input voltage		±10 V	

*51: In the polyphase system, the setting is common to all the phases.

*52: DC or 45 Hz to 65 Hz, the gain is the factory default, the rated output voltage, no load.

10.22.3 External Signal Input (only EXT and ADD)

This multiplies the input signal by the specified gain and outputs it. For ADD, the internal signal source is added.

EXT: Output voltage (V) = External signal input (V) × Gain (V/V)



ADD: Output voltage (V) = External signal input (V) × Gain (V/V)
+ Internal signal source setting (V)

	KP3000S *53	Factory default
Setting Range for gain	100 V range: 0.0 to 220.0 times	100
	200 V range: 0.0 to 440.0 times	200
Setting resolution	0.1	
Gain accuracy *54	±5 %	
Input-output phase	In-phase	
Input terminal	BNC connector (rear panel, unbalanced) Also used as the external synchronization signal input	
Input impedance	1 MΩ	
Input voltage range	±2.2 V (A/D resolution 10 bit)	
Nondestructive maximum input voltage	±10 V	
Input frequency range	DC to 550 Hz (sine wave) DC to 100 Hz (other than sine wave)	

*53: This function cannot be used for the polyphase system.

*54: DC or 45 Hz to 65 Hz, the gain is the factory default, the rated output voltage, no load.

10.23 General Function

	Description	Factory default
LCD display setting	Contrast	0 to 99
	Color	Blue tone or white tone White tone
Beep (key operation, erroneous operation)	On or Off Alarms on abnormal situation regardless of the setting	On
Key lock	On or Off On: Only key lock-off and output-off are available	Off
Output relay control	Enable: The output relay is used to turn the output on/off Disable: The output relay is not used. High impedance to turn the output off	Enable
Output setting at power-on	On or Off On: Output on after power-on	Off
Trigger output setting	Polarity: positive  or negative  Pulse width: 0.1 ms to 10 ms (resolution 0.1 ms)	Negative 10 ms
Time unit setting for Sequence and Simulation	ms or s	s
Reset function	Resets the items stored in the System Setting Memory (excluding the external interface setting) and the items that are to be reset at power-on, to the factory default settings.	

10.24 Memory Function

You can save basic settings (AC/DC mode, signal source, output range, AC setting, DC setting, current limiter, setting range limit, etc.) for each output phase configuration in the non-volatile Basic Setting Memory of No.1 to No.30, and recall them to use when the output is off. The No.1 setting is restored at power-on. The No.0 setting includes the setting items for the factory default.

The external control, display, and other settings are saved in non-volatile System Setting Memory when they are changed by the panel operation or remote command.

The Sequence, Simulation, clipped sine wave, and arbitrary wave are saved in their own non-volatile memories.

Items in the Basic Setting Memory *55

	Factory default
Output range	100 V range
AC/DC mode	AC mode
Signal source	INT
External synchronization signal (LINE or EXT)	LINE
AC voltage setting	0 V
Frequency	50 Hz
Output waveform	Sine wave
Output on phase and output off phase	0.0°
Phase voltage/Line voltage setting selection	Phase voltage
Phase angle setting	Single-phase three-wire: 180° Three-phase four-wire: 120°, 240°
Balanced/Unbalanced	Balanced
DC voltage setting	0 V
Current limiter	Refer to 10.13
Setting range limit	Refer to 10.14
External input gain	100 / 200

*55: Some items do not exist depending on the AC/DC mode or signal source.

Items in the System Setting Memory

	Factory default
Output function	Continuous
DC offset setting	0 mV
Measurement display mode	Normal View
Measurement unit selection	rms
Power unit energization setting	All enabled (energization)
Remote sensing	Off
AGC	Off
General function	See 10.23 (excluding the time unit setting of the Step Time for the Sequence and Simulation)
Monitor output target	Current (L1 phase)
External interface	USB
External control input	Disabled



10.25 Self-diagnosis/Protection Function

At power-on	Description
ROM check	Checks the internal ROM.
RAM check	Checks the internal RAM.
Basic setting Memory check	Checks the Basic Setting Memory.
System Setting Memory check	Checks the System Setting Memory.
Waveform Memory check	Checks the Waveform Memory.
Sequence Memory check	Checks the Sequence Memory.
Simulation Memory check	Checks the Simulation Memory.
Adjustment value memory check	Checks the adjustment data memory.
Version check	Checks the version of the internal software.
System configuration check	Checks the polyphase system.

While energizing	Description
Abnormal output	Turns off the panel display and output when an output overvoltage or overcurrent is detected.
Power unit error	Turns off the panel display and output when a power unit error is detected.
Internal control error	Turns off the panel display and output when an internal communication or other error is detected. Also stops all the operations excluding power-off.

10.26 External Control I/O

When you enabled the external control from the menu, you can control this product by using the external signal (or non voltage contact). The state output is always on. The detection and state switching is done at 10 ms-cycle. If the Remote state is achieved by the external interface, a control input is ignored.

Item		Description	Factory default	
Control input	External control input	Enabled or Disabled		
	Input level	TTL	*56	
	Nondestructive maximum input	+10 V / -5 V		
	Input impedance	Pull-up to +5 V via 47 kΩ		
	Control	Output Off	Falling Off	
		Output On	Falling On	
		Sequence start/resume	*57	Falling Start
		Stop of sequence	*57	Falling Stop
		Sequence is in the Hold status	Falling Hold	
		Sequence branch 1	Falling Branch start	
		Sequence branch 2	Falling Branch start	
		Memory recall (+ compile)	*58	Falling Recall
		Memory specification 1	Specify 0 to 3	
		Memory specification 2	(Equivalent to memory 1 to 4, respectively)	
Clear the current peak-hold value	Falling Clear			
State output	Output level	TTL	*59	
	Output impedance	220 Ω		
	Polarity	*60	Polarity reverse Negative	
	Status	Power On/Off	Low: Off, High: On	
		Output On/Off*	Low: On, High: Off (Negative) Low: Off, High: On (Positive)	
		Protection operation*	Low: Active, High: None (Negative) Low: None, High: Active (Positive)	
		Limiter operation*	Low: Active, High: None (Negative) Low: None, High: Active (Positive)	
		AGC/Autocal setting state*	Low: On, High: Off (Negative) Low: Off, High: On (Positive)	
		Software busy*	Low: Busy, High: Ready (Negative) Low: Ready, High: Busy (Positive)	
		Output range	Low: 200 V, High: 100 V	
		Sequence operation Step sync 1	*57	High level or Low level
Sequence operation Step sync 2		*57		
Trigger	Positive  or negative 			
Terminal 1	D-sub 25-pin multi-connector (rear panel, female, M2.6 screw)			

*56: Low: 0.8 V or lower, High: 2.6 V or higher, the chassis potential.

*57: Sequence start and stop of the control input are effective for the Simulation as well. Also, step sync output 1 and 2 of the control output are effective for the Simulation as well.

*58: The memory recall input of the control input recalls the setting memory for the Normal (Continuous), the Sequence Memory for the Sequence, and the Simulation Memory for the Simulation. For the Sequence and Simulation, the compile data is also included.

*59: Low: 0.4 V or lower, High: 2.7 V or higher, the chassis potential.

*60: Polarity reverse (collective) is available only for the state with *.

10.27 External Interface

This is the interface to control the product from an external computer. The RS232 and USB interfaces are provided by default, and either GPIB or LAN interface can be chosen when ordering. (Both GPIB and LAN cannot be chosen.)

The command language is compliant with the SCPI Specification Version 1999.0. (Factory default is USB).

USB interface (USB1.1) *61

Item	Description
Device class	USBTMC
ID	Already assigned for each device
Terminator	“LF”

*61: The use of USB hub may cause a communication failure. It is recommended to use a fully-shielded, short cable.

RS232 interface *62 *63

Item	Description or Selection	Factory default
Terminal	D-sub 9-pin (male, UNC #4-40 screw)	
Baud rate	9600 / 19200	9600 bps
Terminator	“CR” “LF” / “CR” / “LF”	“CR” “LF”
Parity	None/Odd/Even	None
Stop bit	1 / 2	1 bit
Data bit	7 / 8	8 bit
Flow control	None/Hardware/Software	None

*62: Binary transmission is not supported.

*63: Use a cross cable.

GPIB interface (IEEE488.1 std 1987) *64 *65

Item	Description or Selection	Factory default
Address	0 to 30	2
Terminator	“LF”	

*64: Binary transmission is not supported.

*65: Query for the main unit status byte using a serial poll is not supported.

LAN interface (IEEE802.3, LXI 1.4 Core 2011) *66

Item	Description or Selection	Factory default
Terminal	RJ-45 modular jack	
Transmission method	Ethernet(100BASE-TX / 10BASE-T)	
Communication protocol	SCPI-RAW	
Terminator	“LF”	
IP address setting	Auto, Fixed	Auto

*66: Binary transmission is not supported.

10.28 USB Memory Interface

Commercial USB memory sticks can be used.

		Description
Available memory	*67	USB 1.1 or USB 2.0-compliant product
Connector		USB-A (front panel)
Format		FAT32
Writable/readable contents		Basic Setting Memory, Sequence, Simulation, arbitrary wave
File operation	*68	Create dedicated directory, rename, load, and save 2-byte characters (Japanese, etc.) are not supported.

*67: We do not guarantee that all USB memories can be operational with this product.

*68: The time stamp recorded on a file is different from the actual date and time.

10.29 Waveform Monitor Output

This can monitor the waveform of the output voltage or current. (only one terminal)

		KP3000S
Monitored		Output phase voltage or output phase current (switched)
Gain	Phase voltage	$\frac{1}{200} / \frac{1}{400}$
	Phase current *69	$\frac{1}{100} / \frac{1}{50}$
Accuracy	*70	±5 %
Output terminal		BNC connector (rear panel, unbalanced)
Output impedance		600 Ω

*69: When you set the number of units by the power unit energization setting to 1, the current gain doubles.

*70: No load on the monitor output, the rated output voltage, the resistance load at the maximum current.

10.30 Safety, EMC, and RoHS

Except for LAN interface selected.

		Description
Safety	*71	Compliant with the following standard requirement. EN 61010-1 Pollution Degree 2
EMC	*71 *72 *73	Compliant with the following standard requirement. EN 61326-1 (Group 1, Class A)
RoHS	*71*74	Compliant with the following. Directive 2011/65/EU

*71: Only Models with a CE Marking on the Rear Panel.

*72: Current limiter operation or indication malfunction of LEDs or measured values may occur if the KP3000S is exposed to a strong radiated radio frequency electromagnetic field or a strong radio frequency conducted disturbance.

*73: Electromagnetic emissions from this product may interfere with reception of radio and television broadcasts. Unless the user takes special measures to reduce electromagnetic emissions, using this product in a residential area must be avoided.

*74: For compliant manufacturing lot, please contact us or our agent.

10.31 Operation Environment

KP3000S	
Operation Environment	Indoor, Pollution Degree 2
Altitude	2000 m or lower
Operating temperature/ humidity	0 °C to +50 °C, 5 % to 85 %RH The absolute humidity should be 1 to 25 g/m ³ , without dew condensation. On some specifications, the temperature range limit is stricter.
Storage temperature/ humidity	-10 °C to +60 °C, 5 % to 95 %RH The absolute humidity should be 1 to 29 g/m ³ , without dew condensation.

Figure 10–1 shows the ranges of the ambient temperature and the humidity.

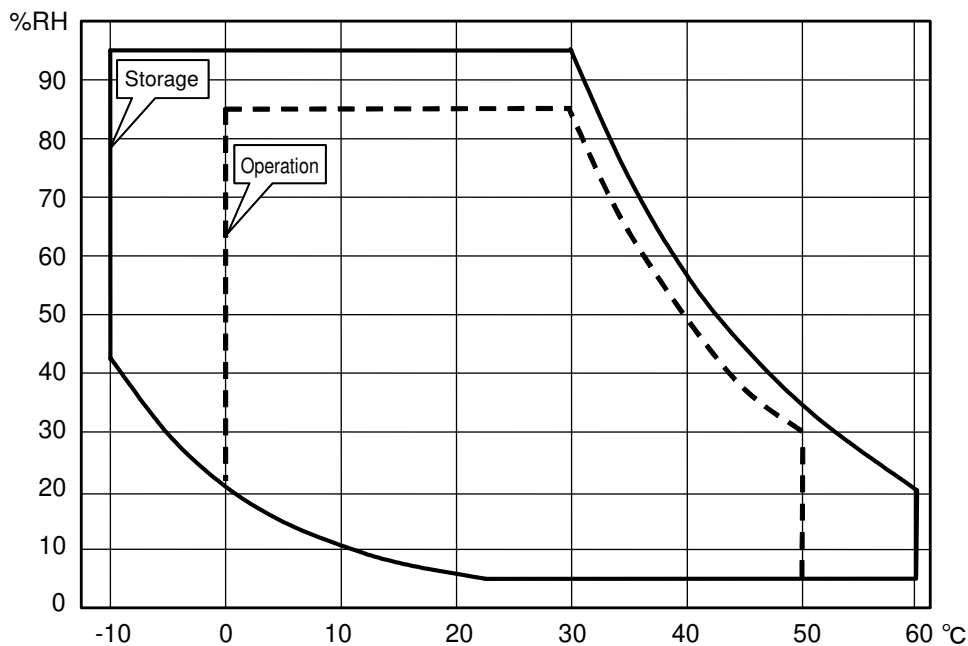

Figure 10-1 Range of Ambient Temperature/Humidity

10.32 Externals, Weight, and Terminal Block

KP3000S	
Dimensions (W×H×D) (Excluding projections)	430×398×561 mm
Weight	50 kg approx.
Power input terminal (rear)	M6 screw
Output terminal (rear)	M6 screw
Outlet (Option, front, 15 A max)	For Japan/North America (NEMA 5-15, 100 V range only)
Sensing input terminal (rear)	M4 screw

10.33 Option

Option name	Description	Remarks
Outlet PA-001-1963	Two outlets for Japan/North America (NEMA 5-15, available in 100 V range) are added at the lower front.	On order
Casters PA-001-1964	In this option casters with the freely movable front-wheels and fixed rear-wheels which can be used to move this product in the horizontal location are attached instead of feet.	After purchase
Control Software for KP Series PA-001-1965	Program that supports the following operation from a PC: The same operations as performed on the panel, Editing/transferring/exporting the arbitrary waveform data, Data logging (importing the measured values), Editing/transferring/exporting/performing Sequence, Editing/transferring/exporting/performing Simulation.	On order and after purchase
System Cable (1P3W) PA-001-1720	Allows you to configure the Single-phase three-wire system by using two KP3000Ss.	On order and after purchase
System Cable (3P4W) PA-001-1721	Allows you to configure the Three-phase four-wire system by using three KP3000Ss.	On order and after purchase
Remote Controller DP008	Multifunctional remote controller with numeric keypad and jog shuttle.	On order and after purchase
Replacement Air Filter PA-001-1966	Replacement air filter.	On order and after purchase
Rack-Mount Adapter EIA (inch) PA-001-1728 JIS (mm) PA-001-1732	The rack-mount adapter is a set of brackets used to mount the product on the EIA or JIS standard compliant rack. Provided for each cabinet size.	On order and after purchase
Additional Power Cable 100 V AC input: PA-001-1973 200 V AC input: PA-001-1974	When you need two or more cables, or when you change the power supply environment, and so on, you can purchase. It is approximately 3 m length.	On order and after purchase

10.34 Outline Dimensional Drawing

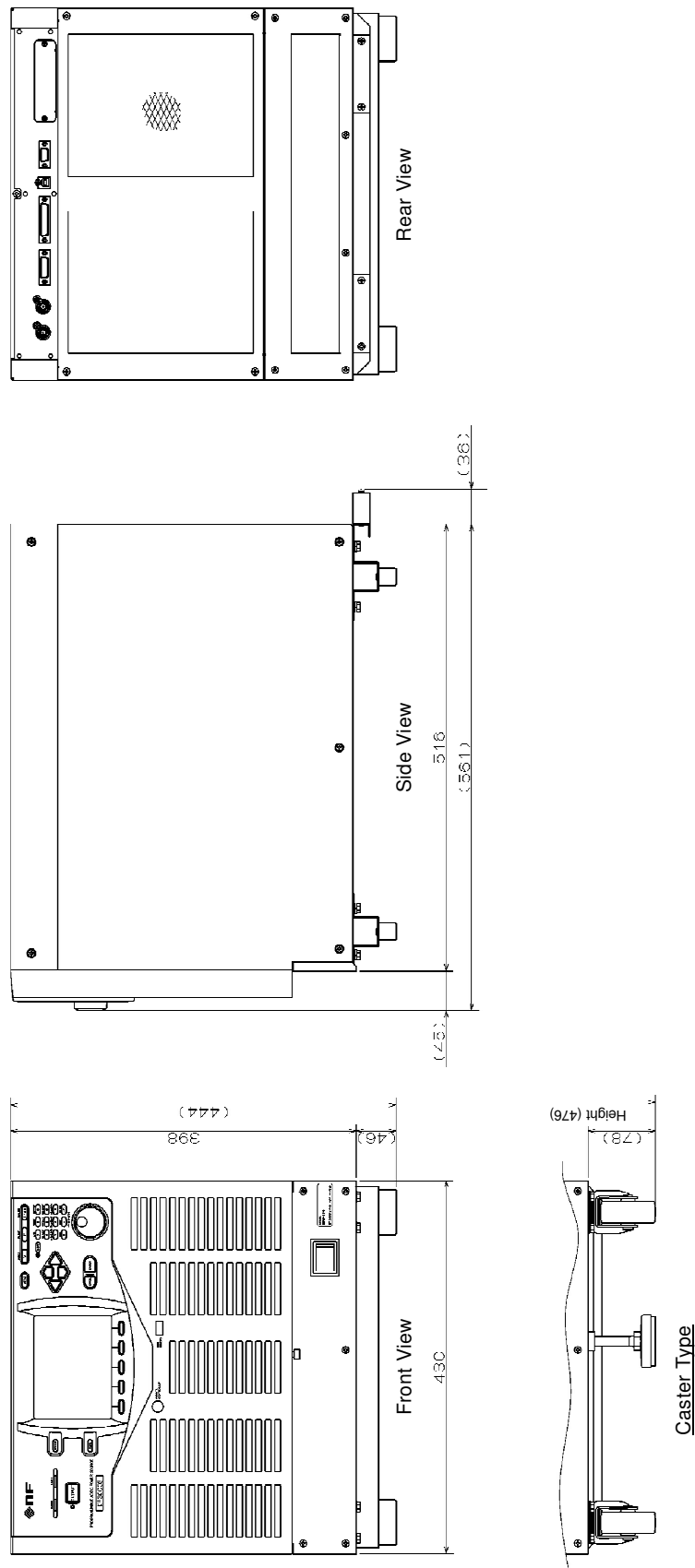

Figure 10-2 Outline Dimensional Drawing

Index

1	
100 V range.....	43
2	
200 V range.....	43
A	
AC coupling.....	40
AC mode.....	40
AC output.....	243
AC/DC mode.....	40
Accessories.....	6
ACDC mode.....	40
active power.....	51
ACV.....	46
ADD.....	40, 178
Adjuster Foot.....	7, 27
AGC.....	155, 195
air filter.....	218, 234
air outlet.....	29
Amplifying the External Signal Input.....	178
apparent power.....	51
arbitrary waveform.....	130
Arbitrary Waveform Memory.....	143
arrow key.....	31
asynchronous.....	176, 195
Autocal.....	158, 195
AVG.....	52
B	
balanced mode.....	47
Basic Setting Memory.....	136, 200
beep.....	186, 201
branch step.....	73
busy.....	195
C	
calibration.....	23
CANCEL key.....	30, 31, 36
caster.....	8, 27, 29
CF.....	52, 129, 196
character string entry box.....	37
circuit breaker.....	16
clip ratio.....	127
clipped sine wave.....	127
compile.....	84, 110
component name.....	26
Const.....	71
Continuous function.....	40, 198
CONTROL I/O connector.....	29
control panel.....	20, 27
crest factor.....	52, 127
D	
data list box.....	35
DC coupling.....	40
DC mode.....	40
DC offset.....	162
DC output.....	245
DCV.....	46
E	
eject operation.....	150
emission CO ₂ calculator.....	182
ENTER key.....	31
error ID.....	220
ERROR LED.....	30
error message.....	220, 223

EXT	40, 178
Ext Control.....	174, 201
external control function	171, 201
external signal input	178
external signal input connector.....	29, 167, 178
ExtOut Pol.....	174, 201

F

F.....	52, 196
F key	30
factory default setting.....	23, 188
firmware version	237
frequency	49
frequency setting range limit.....	67
front grill.....	27, 234
Front grill fixation screw.....	27
front grill holder.....	235

G

GPIB	208
GPIB connector.....	29

H

harmonic current	123, 124
------------------------	----------

I

I.....	51, 196
I key	31
Iavg	51, 196
I _{max}	51, 196
I _{min}	51, 196
Information	201, 237
Initial Step.....	100
inrush current	125
installation environment	6
INT.....	40
Intra-Step parameter.....	70, 100

Ipk-Hold.....	51, 127, 196
---------------	--------------

J

Jog.....	31
Jump count	73
Jump-to step	72

K

Keep.....	71
key lock.....	186, 195

L

LAN	210
LAN connector.....	29
LCD	30, 187, 201
LIMIT LED.....	30
limiter.....	62
limiting action	222
line voltage.....	48
line voltage display	58
Local state	213

M

measured value area	194, 196
measurement function	51
measuring mode	52
Memory function.....	135
MEMORY key	30, 135
Memory View	135
menu composition	198
MENU key	30, 34
Monitor	151, 201
Monitor function	150
monitor output connector	29

N

Normal View	54
numeric keypad	31, 37
numerical entry box.....	37

O

off phase.....	49
on phase	49
operation check	21
options	215
Options.....	215
outlet	16, 27
output cable holder.....	14, 29
output current peak-hold function	126
output current peak-hold value	51, 56, 126
output display area	194
output function	34
OUTPUT key	30
OUTPUT LED	30
output mode	194
output off	50, 222
Output phase configuration	194
output range	43, 194
output relay control	179
output setting display area.....	197
output terminal	14, 29
output voltage.....	46
output-on at power-on setting.....	33, 181

P

P.....	51, 196
Peak	52
peak current limiter	62, 195
PF.....	52, 196
phase current	51, 58, 196
phase voltage.....	47, 58, 164, 196
polyphase system	17, 217
power factor	52, 196

power input cable	11
power input cable holder	12, 29
power input terminal	11, 29
power on/off	31
power switch	27
power unit energization setting.....	33, 184, 195, 221
protection type	220
PU-ON	184, 201, 220, 221
PwOn Mode	97, 121, 201
PwON Output.....	182, 201

Q

Q.....	51, 196
--------	---------

R

rack-mount adapter.....	218
RANGE key	30
rated power icon.....	33, 195
reactive power	51
Relay Cntrl	180, 201
Remote	201, 205, 207, 209, 211
remote controller	27, 217
Remote sensing function	153
Remote state	213
Repeat	102
reset.....	188, 191, 201
RMS	52
RMS current limiter	64, 195
RS232	206
RS232 connector	29

S

S.....	51, 196
screen title.....	194, 220
selection box	34
sensing input terminal	29, 153
Sequence Control View.....	84, 98
Sequence Edit View	77, 98

Sequence function	69, 199
Sequence Memory	80, 147
SHIFT key	31, 39
SHIFT LED	31, 39
Shift state	39
Shortcut operations	39
Shuttle	31
signal source	40
Simple View	54
Simulation Control View	110, 122
Simulation Edit View	110, 122
Simulation function	99, 200
Simulation Memory	148
single-phase	46
single-phase three-wire	17
Soft-key	30, 35
soft-key function	194
Start Phase	74, 101
status icon	194, 195
Step Behavior	71
Step parameter	99
Step sync code output	73, 102
step termination	73
Step Time	72, 100
step-control parameter	70, 100
Stop Phase	74, 101
storage	236
SV	154, 196
SVavg	196
SVmax	196
SVmin	196
SYNC	40, 176
synchronization	176, 195
synchronization frequency	52
System Cable	17, 217
SYSTEM I/O connector	29
System Lock	222

System menu	201
-------------------	-----

T

three-phase	17
Transition Step	100
Transition to	105
Trig Out	74, 102, 175, 201
trigger output	74, 102

U

unbalanced mode	164
USB Communication	204
USB connector	29
USB Eject	150, 201
USB ID	206
USB memory	149
USB memory connector	27
USBTMC	204

V

V	51, 196
V key	30
Vavg	51, 69, 196
VCA	40
VISA	204
Vmax	51, 196
Vmin	51, 196
voltage setting range limit	66

W

wattage limiter	68, 195
waveform	44
window	194

— WARRANTY —

NF Corporation certifies that this product was thoroughly tested and inspected and found to meet its published specifications when it was shipped from our factory. In the unlikely event that you experience an issue during use, please contact our company or agency of our company from which you purchased the product.

All NF products are warranted against defects in materials and workmanship for a period of one year from the date of shipment. During the warranty period, NF will repair the defective product without any charge for the parts and labor.

For repair service under warranty, the product must be returned to either NF or an agent designated by NF. The Purchaser shall prepay all shipping cost, duties and taxes for the product to NF from another country, and NF shall pay shipping charges to return the product to the purchaser.

This warranty shall not apply when corresponding to following particulars.

- A) Failure caused by improper handling or use of the product in a manner that does not conform with the provisions of the Instruction Manual.
- B) Failure or damage caused by transport, dropping, or other handling of the product after purchase.
- C) Failure caused by repair, adjustment, or modification of the product by a company, organization, or individual not approved by NF.
- D) Failure caused by abnormal voltage or the influence of equipment connected to this product.
- E) Failure caused by the influence of supply parts from the customer.
- F) Failure caused by such as corrosion that originate in the use of causticity gas, organic solvent, and chemical.
- G) Failure caused by the insect or small animal that invaded from the outside.
- H) Failure or damage caused by fire, earthquakes, flood damage, lightning, war, or other uncontrollable accident.
- I) Failure caused by the reason that was not able to be foreseen by the science and technology level when shipped from our company.
- J) Replacement and replenishment of consumables such as batteries.

NF Corporation

WABUN: (DA00030907)

If there are any misplaced or missing pages, we will replace the manual. Contact the sales representative.

NOTES

- Reproduction of the contents of this manual is forbidden by applicable laws.
- The contents of this manual may be revised without notice.
- Information provided in this manual is intended to be accurate and reliable. However, we assume no responsibility for any damage regarding the contents of this manual.
- We assume no responsibility for influences resulting from the operations in this manual.

©Copyright 2011-2022, **NF Corporation**

Programmable AC/DC Power Source KP3000S
Instruction Manual

NF Corporation

6-3-20, Tsunashima Higashi, Kohoku-ku, Yokohama
223-8508 JAPAN
Phone +81-45-545-8111 Fax +81-45-545-8191

