

# GPR-x800 (A)IS Oxygen Analyzers

## User Manual PST-UM-3001-EN-03



Issue No.	Description	Date	Author Initials
01	Original document issued	01/2016	PP
02		02/2020	
03	* Re-brand template * Hazardous area information * New firmware information	08/2023	IMC



GPR-x800 (A)IS Oxygen Analyzers

For contact information, visit  
[ProcessSensing.com](http://ProcessSensing.com)

Analytical Industries Inc (Aii) is part of the Process Sensing Technologies Group (PST). This document is the property of Process Sensing Technologies and may not be copied or otherwise reproduced, communicated to third parties, nor stored in any Data Processing System without the express written authorization of Process Sensing Technologies.

©2023 Process Sensing Technologies

## Before using your GPR-x800 (A)IS

### Safety information

Please read this manual, ensuring that you fully understand the content before attempting to setup, maintain or use the GPR-x800 (A)IS. Important safety information is highlighted throughout this document as follows:



The electrical warning symbol indicates instructions that must be followed to avoid serious or fatal injury from hazardous voltages and electric shock.



The warning symbol indicates instructions that must be followed to avoid minor, serious or even fatal injury to personnel.



The **electrostatic discharge (ESD) warning** symbol indicates the user must take precautions and follow the necessary steps to avoid generating electrostatic discharge.



The **caution** symbol indicates instructions that must be followed to avoid damage to equipment (hardware and/or software) or the occurrence of a system failure.

**NOTE:** Highlights an essential operating procedure, condition, or statement.

## Abbreviations

AC	Alternating Current
DC	Direct Current
°C	Degrees celcius
°F	Degrees fahrenheit
EC	Electrochemical
ELV	Extra Low Voltage
ESD	Electrostatic Discharge
FSD	Full-scale Deflection
g	Grams
GND	Ground
kg	Kilograms
lb	Pounds
LD	Liquid Drain
LDL	Lower Detection Limit
LED	Light Emitting Diode
LPM	Liters Per Minute
mA	Milliampere
OEM	Original Equipment Manufacturer
oz	Ounces
PC	Personal Computer
PCB	Printed Circuit Board
PLC	Programmable Logic Controller
ppb	Parts Per Billion
ppm	Parts Per Million
SCFH	Standard Cubic Feet per Hour
SS	Stainless Steel

# Contents

Before using your GPR-x800 (A)IS .....	iii
Safety information .....	iii
Abbreviations .....	iv
<b>1 Introduction .....</b>	<b>1</b>
1.1 Overview .....	1
1.2 Models .....	2
1.2.1 GPR-x800 IS .....	2
1.2.2 GPR-x800 AIS .....	2
1.2.3 GPR-x800 (A)IS-LD .....	2
1.3 Applications .....	2
1.4 Sensors .....	3
1.4.1 PST (Aii) GPR-12-333 Sensor .....	3
1.4.2 PST (Aii) -LD suffix Sensor .....	3
1.4.3 PST (Aii) GPR-12-333-H Sensor .....	3
1.4.4 PST (Aii) XLT-12-333 Sensor .....	4
1.4.5 PST (Aii) GPR-11-60 Sensor .....	4
1.4.6 PST (Aii) XLT-11-24 Sensor .....	4
1.5 Further general considerations .....	4
1.5.1 Conditions of use in hazardous areas .....	5
1.6 Safety approvals and directives .....	6
<b>2 Installation .....</b>	<b>7</b>
2.1 Unpack your analyzer .....	7
2.2 System components .....	9
2.3 Mount your analyzer .....	9
<b>3 Connection .....</b>	<b>10</b>
3.1 Connect your power supply (IS models) .....	10
3.2 Connect your power supply, alarms and outputs (AIS model only) .....	11
3.2.1 Power supply .....	11
3.2.2 Alarms .....	11
3.2.3 Outputs .....	12
Analog output .....	12
Digital Output .....	12
3.3 Hazardous area connections .....	12
<b>4 Sensor installation .....</b>	<b>13</b>
<b>5 Before connecting gas .....</b>	<b>15</b>
5.1 Necessary considerations before gas connection .....	15
5.2 Connect your gas .....	17
5.3 Calibration gases .....	17
5.4 Sample gas requirements .....	18
5.4.1 Inlet pressure .....	18
5.4.2 Outlet pressure .....	18
5.5 Prepare your zero/span gas .....	18

<b>6 Operation</b> .....	<b>20</b>
6.1 User interface .....	20
6.2 Initial start-up and self-test .....	21
6.3 Menus .....	22
6.3.1 Main Menu and interface keys .....	22
Range .....	22
Calibration .....	22
System .....	22
Info .....	22
6.3.2 Range selection .....	23
Range menu options .....	23
Measurements outside manual range .....	24
6.3.3 Analyzer calibration .....	24
Set sensor serial .....	24
Zero and span vs span calibration .....	25
Span calibration .....	26
Zero calibration .....	27
Calibration log .....	28
6.3.4 Alarms .....	28
On/Off .....	29
Setpoint .....	29
Mode .....	29
Delay .....	29
Latching .....	29
Failsafe .....	29
6.3.5 System .....	29
Security .....	30
Calibrate 4...20 mA .....	30
Modbus .....	30
Signal AV - signal average .....	30
Clipping .....	30
Time .....	30
Date form .....	30
Date .....	30
Range scale .....	31
Unit ID .....	31
Factory reset .....	31
6.3.6 Info .....	31
<b>7 Maintenance</b> .....	<b>32</b>
7.1 Sensor replacement .....	32
7.2 Routine cleaning .....	32
7.3 Routine inspection of sensor housing .....	33
7.4 Troubleshooting .....	33
7.5 Spare parts .....	36
<b>8 Warranty information</b> .....	<b>37</b>
8.1 Coverage .....	37
8.2 Limitations .....	37
8.3 Exclusions .....	37
8.4 Service .....	38
<b>9 Appendices</b> .....	<b>39</b>
Appendix A - Technical Specifications .....	39
Appendix B - Hazardous Area Certification .....	40

---

Appendix C - Safety Data Sheet .....	41
Appendix D - Controlled drawings .....	49
Appendix E - Mounting information .....	51
Appendix F - Modbus register (AIS only) .....	52
Appendix G - Menu displays .....	53
Appendix H - Rating plates .....	54
Appendix I - Quality, recycling, and warranty information .....	55

**This page is intentionally blank.**



# 1 Introduction

This user manual is applicable to the GPR-1800 IS, GPR-1800 AIS, GPR-2800 IS and GPR-2800 AIS oxygen analyzers.

**!** These products are for indoor and outdoor use. If they are used in a manner not specified by the manufacturer, the protection provided by this equipment may be impaired.

This document contains the following information for your analyzer:

- Installation
- Connection
- Operation
- Maintenance and troubleshooting.

To ensure that the latest manual is being used please visit the PST website [www.processsensing.com](http://www.processsensing.com).

Access the latest datasheets, user manuals, certificates and more at the product page **Downloads** tab.



GPR-1800 (A)IS



GPR-2800 (A)IS

## 1.1 Overview

GPR oxygen analyzers are reliable, compact, robust, and designed to perform verification measurements in a variety of industrial oxygen applications.

Features of GPR-x800 (A)IS analyzers include:

- Simple, intuitive HMI
- Sensors available for measurement in CO<sub>2</sub> or H<sub>2</sub> gases
- User-selectable or automatic adjusted measurement ranges
- Gas temperature compensation
- Loop or line-powered configurations
- Range of sampling options available for different applications
- Two user-configurable alarms (AIS only)
- Modbus digital output (AIS only).

## 1.2 Models

The GPR-x800 (A)IS range of oxygen analyzers covered in this manual are detailed as follows:

- GPR-1800 - ppm oxygen online analyzer
- GPR-2800 - % oxygen online analyzer

Both of these have two sub-variants IS and AIS. All of these configurations can be suffixed with "LD" for applications that have liquids present in the gas sample.

All of the variants are certified for hazardous area installation.

### 1.2.1 GPR-x800 IS

This analyzer is a loop-powered analyzer that can be mounted in a hazardous area. See "Appendix B - Hazardous Area Certification" on page 40.

The IS configuration has a local display and a signal re-transmission of the measured value through the 4...20 mA loop.

### 1.2.2 GPR-x800 AIS

The AIS analyzer is a line-powered and has a powered 4...20 mA output of the measured value, along with two user-configurable alarms with relay outputs.

It has a local display and can be mounted in a hazardous area when installed in accordance with the details in "Appendix B - Hazardous Area Certification" on page 40.

### 1.2.3 GPR-x800 (A)IS-LD

The -LD (Liquid Drain) suffix configures any of the analyzers (GPR-x800-(A)IS) for use in applications where the sample gas cannot contain liquids. LD involves a different mechanical build "Appendix E - Mounting information" on page 51.

The analyzer also has a local display. The LD sensor is in a screw-in housing with a 4-pin molex process connection.

## 1.3 Applications

- Monitoring inertization and blanketing gases for the storage or transport of hydrocarbons
- Monitoring natural gas quality
- Monitoring oxygen in pharmaceutical reactors and centrifuges

## 1.4 Sensors

Our maintenance-free electrochemical sensors are galvanic cells capable of superior performance, accuracy and stability; designed to be unaffected by the presence of background gases. As a consumptive sensor type, it is disposable and requires only periodic calibrations.

Operational life is typically up to 18 months however, replacement frequency is dependent on the individual application.

If contaminants are present in the sample gas, the sensor can be affected, and the validity of the measurement impacted. Please ensure that the sensor is protected, and any contamination is prevented from reaching the analyzer's pipework and the sensor.

Consult the PST-Aii sales team about our cost-effective standard sample conditioning systems.

**Table 1: Available sensor types:**

				
<b>Analyzer model</b>	GPR-1800 (A)IS	GPR-2800 (A)IS	GPR-1800 (A)IS	GPR-2800 (A)IS
<b>Model number</b>	GPR-12-333 / GPR-12-333-LD / GPR-12-333-H	GPR-11-60 / GPR- 11-60-LD	XLT-12-333 / XLT- 12-333-LD	XLT-11-24 / XLT- 11-24-LD
<b>Recommended O<sub>2</sub> Measurement Range</b>	0...1000 ppm <sub>v</sub>	0...25 %	0...1000 ppm <sub>v</sub>	0...25 %
<b>Minimum Range</b>	0...10 ppm <sub>v</sub>	0...1 %	0...10 ppm <sub>v</sub>	0...1 %
<b>Sensitivity</b>	0.01 ppm <sub>v</sub>	0.005 %	0.01 ppm <sub>v</sub>	0.005 %

For full sensor technical specifications, please refer to "Appendix A - Technical Specifications" on page 39.

### 1.4.1 PST (Aii) GPR-12-333 Sensor

Our standard ppm sensor can be used to measure oxygen in a wide variety of gases.

Specific sensor selection should be given when the background gases are helium (He), hydrogen (H<sub>2</sub>) or > 0.5 % carbon dioxide (CO<sub>2</sub>).

### 1.4.2 PST (Aii) -LD suffix Sensor

This is the standard sensor for use with sample gas containing occasional liquid. The LD sensor is in a screw-in housing and has a 4-pin molex process connection. The sensor itself is the same as standard.

### 1.4.3 PST (Aii) GPR-12-333-H Sensor

In applications with a background gas of helium or hydrogen, we recommend using the -H sensor.

This sensor has the same construction as the standard sensor but a different electrolyte formula enables a quick measurement response with He and H<sub>2</sub> background gases.

#### 1.4.4 PST (Aii) XLT-12-333 Sensor

For measurement applications with ppm levels of oxygen in a background gas containing more than 0.5 % CO<sub>2</sub>, the specially designed XLT sensor should be selected.

With most standard electrochemical sensors, an alkaline electrolyte is used; this is neutralized over time when exposed to acidic gases, such as CO<sub>2</sub>. To combat this, Aii has developed the XLT sensor with a special electrolyte formula, which maintains functionality in temperatures as low as -10 °C.

#### 1.4.5 PST (Aii) GPR-11-60 Sensor

Our standard % sensor can be used to measure oxygen in a wide variety of gases.

#### 1.4.6 PST (Aii) XLT-11-24 Sensor

For measurement applications with % levels of oxygen in a background gas containing more than 0.5 % CO<sub>2</sub>, the specially designed XLT sensor should be selected.

**NOTE: Calibration is required each time your sensor is replaced. Ideally, your sensor should be replaced before reaching the end of its operational life.**

### 1.5 Further general considerations

When your GPR-x800 (A)IS analyzer is used with or in other equipment please consider the following:

- The analyzer should not be submerged in any liquid. Care should be taken to ensure liquids are not spilled and objects do not fall into the unit.
- Avoid force when using connectors, switches and knobs. Before moving your analyzer, be sure to disconnect the wiring/power cord and any cables connected to the output terminals.
- Ensure the sensor selected and supplied is suitable for the gas composition to which it will be presented; if in doubt, review the application and consult the PST-Aii Factory before initiating the installation.
- The products covered should be evaluated to the environmental conditions as defined by the standard up to 2000m altitude and within the temperature range applicable to your sensor; refer to "Appendix A - Technical Specifications" for details.
- The current rating and size of the power supply cable should be appropriate to the equipment.
- The products covered by this manual should be installed using the manufacturer's instructions.
- Only the sensor provided by the manufacturer is to be used with the analyzer.

**NOTE: In natural gas applications such as extraction and transmission, a low voltage current is applied to the pipeline itself to inhibit corrosion of the pipeline. As a result, electronic devices connected to the pipeline can be affected unless they are adequately grounded.**

### 1.5.1 Conditions of use in hazardous areas

**NOTE:** Always ensure the power is switched off prior to accessing the Ex enclosure for any purpose other than normal operation, or prior to disconnecting any cables.

Refer to "Appendix B - Hazardous Area Certification" on page 40 for certification details.

i) All versions of the enclosure are manufactured in aluminum. In rare cases, ignition sources due to impact and friction sparks could occur. This shall be considered during installation, particularly if the equipment is installed in a Zone 0 location.

ii) The online gas analyzers has non-metallic parts incorporated in the enclosure of this equipment which may generate an ignition-capable level of electrostatic charge, under certain extreme circumstances. Therefore, the equipment shall not be installed in a location where the external conditions are conducive to the build-up of electrostatic charge on such surfaces. This is particularly important if the equipment is installed in a Zone 0 location. In addition, the equipment shall only be cleaned with a damp cloth.

iii) The online gas analyzer is not capable of withstanding the 500 V insulation test required by Clause 6.3.12 of IEC 60079-11. This shall be taken into account when installing the equipment.

iv) When connected using a conduit system, the explosion-proof enclosures type Adalet type XIHLX require conduit seals that satisfy the requirements in "Table 2: Conduit seal requirements" must be used.

**Table 2: Conduit seal requirements**

Size	Seals
1"	Within 1.8"
3/4"	Optional
1/2"	Optional

v) When connected with cable glands, the glands shall be a suitably Listed Explosion-proof type, suitable for the applicable Class and Division or Class and Zone, Gas Group, T-Class and ambient temperature. It shall only employ sealing around individual cores. Additional thread adapters shall not be used.

1.6 Safety approvals and directives



The CE marking indicates GPR-x800 (A)IS oxygen analyzer conformity to European health, safety, safety and environmental protection directives.



The Ex marking indicates GPR-x800 (A)IS oxygen analyzer conformity to European Union directive 2014/34/EU (ATEX) and UK Statutory Instrument 2016 No. 1107 (as amended) (UKEX). It complies with Intrinsically Safe (I.S) standards for equipment category 2 when used following the instructions for safe use in this user manual. This makes it normally suitable for use in Zones 1 or 2 hazardous areas.



This UKCA marking demonstrates GPR-x800 (A)IS oxygen analyzer complies with UK designated standards in electric and electronic engineering and measuring technology.



The MET marking certifies GPR-x800 (A)IS oxygen analyzer is compliant in North America and Canada, with the electrical and hazardous location safety directive.

**NOTE:** The GPR-x800 (A)IS range of analyzers are not tri-rated. These analyzers are built to comply with ATEX / IECEx / UKEX or cMETus. The hazardous area compliance rating is shown on the rating plate on the analyzer. Please ensure your analyzer is compliant with site or location requirements. This manual details installation, operation and support for all GPR-x800 (A)IS analyzers for all certifications.

## 2 Installation

NOTE: Installation, operation and maintenance of this equipment should be carried out only by appropriately trained and suitably qualified technicians in accordance with the instructions in this user manual, and any applicable standards /certificates associated with the country, industry and application.



Failure to correctly adhere to these instructions may result in serious or even fatal injury. In this regard, the manufacturer will not be held liable.

NOTE: The operator may only perform modifications and repairs to the equipment or system with approval from the manufacturer.



Do not operate damaged equipment. If faults cannot be rectified, the equipment must be taken out of service and secured against unintentional commissioning.

Before using your GPR-x800 (A)IS, ensure that its specifications are suitable for the process in which it will be installed.

### 2.1 Unpack your analyzer

If sold separately (not part of a sampling system), the GPR-x800 (A)IS will be supplied in a custom box which should be retained for future use (such as a service return).

Your GPR-x800 (A)IS analyzer pack is comprised of the following equipment (pack contents may vary depending on your specification):

1. GPR-x800 (A)IS analyzer
2. Sensor (in double-foil bag pack)
3. PST-Aii Factory calibration certificate
4. Quick Start Guides (ref: PST-QSG-3002, span calibration, PST-QSG-3003, air calibration)
5. User Manual, this document (ref: PST-UM-3001)



Figure 1. Contents of GPR-x800 (A)IS pack



## 2.2 System components

The GPR-x800 (A)IS analyzer consists of two interconnected enclosures (without the optional sample conditioning system and panel) and measures 16.5" (L) x 5.4" (W) x 10" (H).



Figure 2. The GPR-x800 (A)IS line-powered oxygen analyzer set-up

## 2.3 Mount your analyzer

The analyzer is approved for indoor as well as outdoor use. However, avoid mounting in an area where direct sun might heat up the analyzer beyond the recommended operating temperature range. If possible, install a small hood over the analyzer for rain water drain and to prevent over-heating of analyzer.

- Find the appropriate location to install the analyzer.
- Ensure that the mounting and operation is only in the upright vertical orientation.
- To facilitate convenient servicing the interior of the transmitters, secure the back plate to a vertical surface approximately 1.5 m (5 ft) from the floor or a level accessible to service personnel. This requires the user to supply four (4) additional proper size screws and anchors.

**NOTE: For installations where temperature can be expected to fall below -18 °C (0 °F) please consult PST-Aii Sales to discuss heated enclosure options.**

This GPR-x800 (A)IS configuration is designed to be mounted directly to any flat vertical surface, wall or bulkhead plate. Please see "Appendix E - Mounting information" on page 51.

The analyzer's design provides immunity from RFI/EMI by maintaining good conductive contact between the two halves of the enclosures via a conductive gasket (the smaller enclosure containing signal processing electronics).

The surfaces contacting the conductive gasket are unpainted. Do not paint these areas. Painting will negate the RFI/EMI protection.

**⚠ Do not remove or discard the gaskets from either the Ex enclosure or the fiberglass enclosure. Failure to reinstall either of the gaskets will void the NEMA 4, UL Type 3R rating and the immunity to RFI/EMI.**

For mounting requirements and information, please refer to "Appendix E - Mounting information" on page 51.

### 3 Connection

Supply power to the analyzer only as rated by the specification or markings on the analyzer enclosure. The wiring that connects the analyzer to the power source should be installed in accordance with recognized electrical standards.

Ensure that the analyzer case is properly grounded and meets the requirements for area classification where the analyzer is installed. Never use force when removing wiring from a terminal connection.

#### 3.1 Connect your power supply (IS models)

This configuration is **loop-powered**; it requires a 18...24 V DC power supply on a 4...20 mA loop.

Incoming power is connected via a 3-way terminal block mounted on a PCB, which is located within the explosion-proof enclosure.

**!** Do not supply voltage more than specified in this manual and noted near the power input terminal of the analyzer.

**!** Do not apply line-power to the GPR-1800 IS or to the GPR-2800 IS. If line-power is applied to an IS-configured analyzer, it will result in damage to the main PCB.



*Figure 3. Wiring and connections (IS models)*

The maximum power consumption for GPR-x800 IS analyzers is no more than 1 W.

### 3.2 Connect your power supply, alarms and outputs (AIS model only)

This configuration is **line-powered**; it requires a DC line supply - 24 V DC nominal (28 V DC maximum).

Incoming power, alarm relays, and signal output connections are made to 3 terminal blocks mounted on a PCB located in the explosion proof enclosure.

#### 3.2.1 Power supply

Do not supply voltage more than specified in this manual (voltage supply is also noted near the analyzer's power input terminal).



Figure 4. Wiring and connections (AIS models)

The PCB in the flame-proof enclosure contains a power-limiting intrinsically safe barrier that limits the total power available to the analyzer in the general-purpose enclosure.

For the GPR-x800 AIS models, power consumption must not exceed 28 W.

#### 3.2.2 Alarms

The analyzer has two alarm relay contacts.

Table 3: Alarm relay contact rating

Alarm relay contact rating: 3A @ 28 V AC or 3A @ 28 V DC	Relay 2 (NO)
	Relay 2 (NC)
	Relay 1 (NO)
	Relay 1 (NC)

- **Type:** SPCO (NO, NC and C)
- **Contact Rating, Max:** 2 A, 250 V AC
- Hysteresis is 2 % of the set point
- AL1 and AL2 can be configured as **OFF**, **LOW** or **HIGH**

- A low alarm switches on when % O<sub>2</sub> is below the set point, and switches off when % O<sub>2</sub> is above the set point + hysteresis
- A high alarm switches on when % O<sub>2</sub> is above the set point and switches off when % O<sub>2</sub> is below the set point – hysteresis.

### 3.2.3 Outputs

AIS analyzer models have one 4...20 analog and one Modbus over RS485 digital serial output. There are two user-configurable **HIGH** and **LOW** alarms as shown in "Table 3: Alarm relay contact rating" on page 11.

#### Analog output

The analyzer has one 4...20 mA linear signal output channel. The 4...20 mA signal is powered by the AIS analyzer.

#### Digital Output

The analyzer has Modbus (RTU) communications over RS485.

- **Type:** Modbus RTU over RS485
- **RS485:** 2-wire (plus ground)
- **Baud rate:** User-selectable through menu 9600 / 28800 / 57600 / 115200 / 230400 BPS
- **Parity:** User-selectable through menu - EVEN / ODD / NONE
- **Data bits:** 8
- **Stop bits:** 1

## 3.3 Hazardous area connections

For installation in a hazardous area:

- Entity parameters for all connection facilities are as follows:
  - o **U<sub>i</sub> = 28 V DC, I<sub>i</sub> = 93 mA (loop-powered)**
  - o **U<sub>m</sub> = U<sub>max</sub> = 28 V DC (line-powered)**
- All cables must be shielded to ground at customer side
- Use a certified cable gland or stopper box
- The power cable to the Ex enclosure must be supplied through a conduit approved for use in hazardous areas.
- Secure the wires to the power input terminal block by using the integral screws of the terminal block. Do not substitute terminal screws. Refer to "Table 2: Conduit seal requirements" on page 5 for more information.

## 4 Sensor installation

The GPR-x800 (A)IS oxygen analyzer is equipped with stainless steel sensor housing. This housing offers ease of replacement of sensor whilst preventing any leakage into the system. The two sections of the sensor are held together by a metal clamp secured in place by an easily accessed bolt.

The integrity of the sensor housing has been tested at the PST-Aii Factory prior to shipment.

The analyzer must be calibrated once the installation has been completed and periodically thereafter.

To install or replace an oxygen sensor:

1. Apply power to your analyzer (refer to Figure 4 on page 11 for guidance).
2. Using the two latches, open the front window of the enclosure.
3. Open the sensor housing (refer to [Figure 5](#) below for guidance).

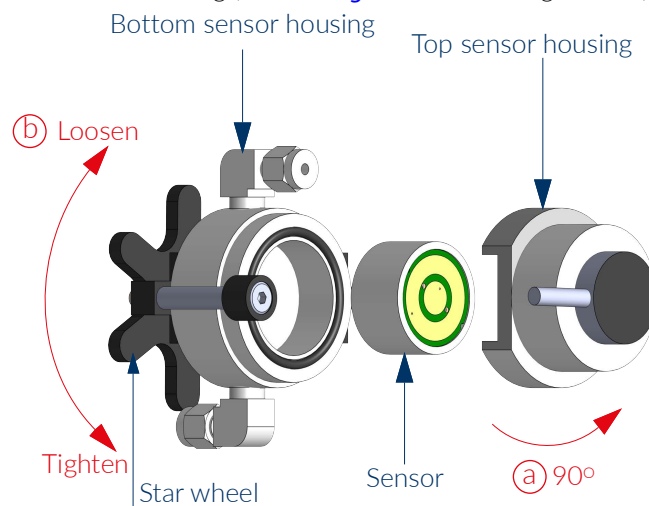

*Figure 5. Installing and uninstalling your sensor*

4. Loosen the star wheel then disengage the top sensor housing by turning it 90° counter-clockwise.
5. If replacing your sensor, remove the old sensor from the sensor housing, otherwise continue to the next step.
6. Remove the sensor from its packaging, remove the shorting flags and immediately place in the top sensor housing with the gold contact plate facing towards two gold contact pins in the top sensor housing as shown in [Figure 6](#)



*Figure 6. Aligning your sensor*

7. You may perform a zero and span calibration or an air calibration to confirm that the sensor output is within the recommended limits. See "Zero and span vs span calibration" on page 25 and for guidance.
8. Secure it with the star wheel at the bottom of the housing assembly (refer to 'b' in Figure 5 on page 13).
9. Quickly close your analyzer and connect your process sample gas or zero oxygen gas immediately.



**Always minimize the time that the sensor is exposed to ambient air.**

## 5 Before connecting gas

### 5.1 Necessary considerations before gas connection

With standard flow-through configuration, the GPR-x800 (A)IS analyzers are designed for positive pressure samples and require connections for incoming sample and outgoing vent lines.

Your analyzer is equipped with two gas ports as shown in [Figure 7](#).

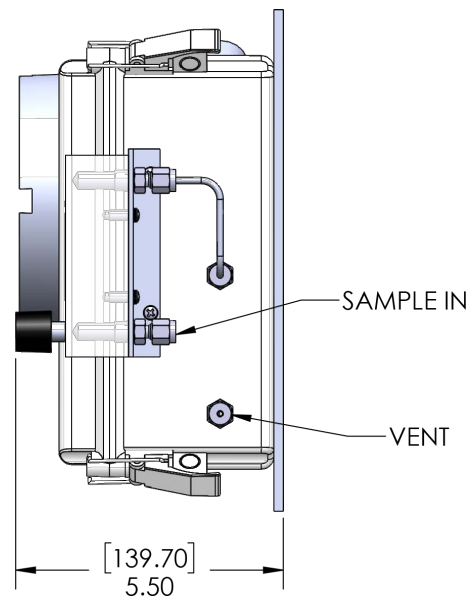

*Figure 7. Gas ports (right elevation)*

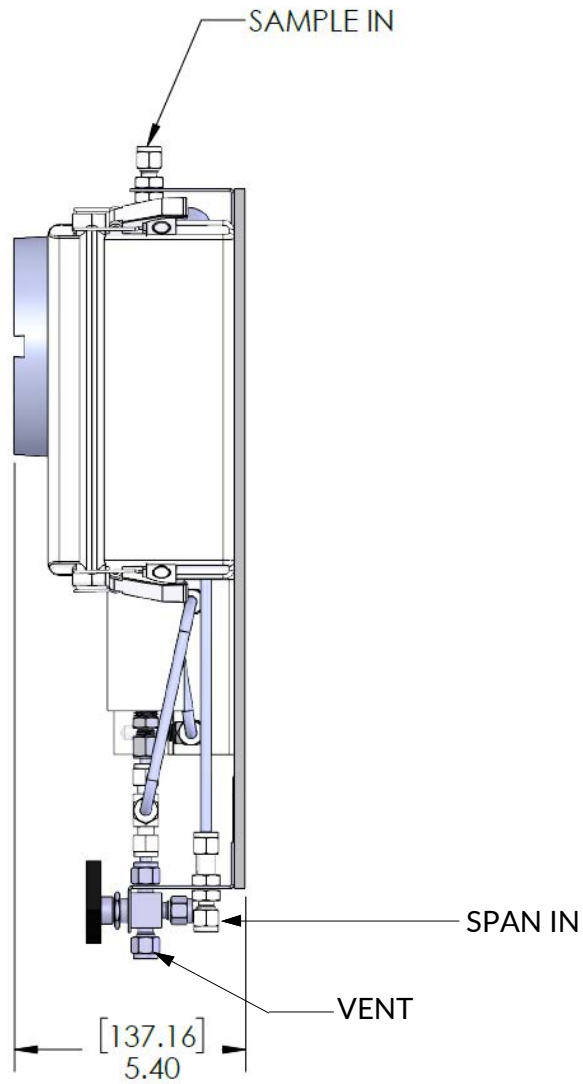

Figure 8. Gas ports: LD system (bottom elevation)

The inlet and outlet vent gas lines require 1/4" stainless steel compression type tube fittings.

The sample inlet tubing must be metallic, preferably stainless steel (SS). The sample vent line may be of SS or hard plastic tubing with low gas permeability.



To ensure the best possible operation, a review of the installation is recommended:

- a. Sample gas quality
  - Is the sensor suitable for gas?
  - Is a gas scrubber required?
  - Is the sample gas clean and liquid free?
- b. Stainless steel tubing (essential for maintaining the integrity of the gas stream for very low ppm or % level analysis).

**NOTE: If operated in potentially contaminated gases, which can interfere with measurement and reduce the sensor's life expectancy. Consult PST-Aii for recommendations concerning the proper selection and installation of components.**

## 5.2 Connect your gas

To connect your gas:

1. See [Figure 7 on page 15](#) for port designation and connect your **Sample** and **Vent** lines accordingly.
2. Regulate the sample pressure as described in below in "5.3 Calibration gases".
3. Connect a 1/8" or 1/4" vent line to the compression fitting to be used for venting the sample.
4. Connect a 1/8" or 1/4" sample line to the compression fitting to be used to bring sample gas to the analyzer.
5. Set the **Sample** gas pressure between 5...30 psig.
6. Select sample gas and allow it to flow through the analyzers and set the flow rate to 1...2 SCFH (0.5...1 LPM).

**Zero and span calibration gas ports are offered as part of the optional sample systems.**

**NOTE: If the analyzer is equipped with an optional H<sub>2</sub>S scrubber, sample inlet pressure must not exceed 30 psig.**

 **Do not place your finger over the vent (it pressurizes the sensor) to test the flow indicator when gas is flowing to the sensor. Removing your finger (the restriction) generates a vacuum on the sensor and may damage the sensor, voiding the sensor warranty.**

## 5.3 Calibration gases

**NOTE: It is recommended that you use a certified zero and span gases for calibration to ensure the best measurement readings.**

Cylinders of the appropriate certified zero and span gases should be made available for installation and commissioning. Calibration gases will need to be set to the same input pressure and flow rate as the sample gas to ensure calibration integrity.

## 5.4 Sample gas requirements

All gas analyzers utilizing electrochemical oxygen sensors respond to partial pressure changes in oxygen. To ensure accurate measurement of the oxygen sample, gas must be presented to the analyzer at a stable pressure and flow rate.

### 5.4.1 Inlet pressure

For the analyzers designed to measure oxygen in a flowing gas stream, the inlet sample pressure must be regulated in the range 5...30 psig.

### 5.4.2 Outlet pressure

The sample must be vented at a pressure less than the inlet pressure so that the sample gas can flow through the sensor housing. Ideally, the sample should be vented to the atmosphere or into a flare at atmospheric pressure.

**NOTE: The sensor may be used at a slightly positive pressure (e.g., when sample is vented to a common exhaust where the pressure might be higher than 1 atmosphere). However, the pressure at the sensor must remain constant at all times including during the span calibration. This may be accomplished by using a back-pressure regulator on the vent line of the analyzer.**

If assistance is required to configure a measurement at a positive pressure, please contact PST-Aii with full application details for a review.



**A sudden change in pressure at the sensor may result in the sensor electrolyte leakage.**

## 5.5 Prepare your zero/span gas

Avoid contamination of the zero/span gas cylinder when connecting the pressure regulator. Bleed the air-filled regulator for a couple of minutes before closing the vent valve of the pressure regulator (faster and more reliable method of purging the regulator than simply allowing the zero/span gas to flow through the regulator and the span gas line).

The following components/tools are required to set up a zero/span gas cylinder:

- a. Certified zero/span gas cylinder with an oxygen concentration, balance nitrogen, of approximately 80 % of the full scale range above the intended measuring range.
- b. A pressure regulator to enable reduction of gas pressure to between 5 and 30 psig.
- c. A flow meter (for use only if the analyzer is not equipped with one) to set the flow rate between 1 and 2 SCFH (0.5...1 LPM).
- d. Suitable fittings and 1/8" diameter metal tubing to connect the regulator to the inlet of the analyzer.

Ensure your zero/span gas cylinder valve is closed, then:

1. Install the regulator on the cylinder using good practice.
2. Open the regulator's exit valve and partially open the pressure regulator's control knob.

3. Slightly open the cylinder valve.
4. Loosen the nut connecting the regulator to the cylinder and bleed the pressure regulator.
5. Re-tighten the nut connecting the regulator to the cylinder.
6. Adjust the regulator exit valve and slowly bleed the pressure regulator.
7. Open the cylinder valve completely.
8. Set the output pressure between 5 and 30 psig using the pressure regulator's control knob.

 **Do not exceed the recommended pressure. Excessive pressure will make flow adjustment more difficult.**

## 6 Operation

This section details the best practice operation for a correctly installed analyzer. Please refer to "2 Installation" on page 7 for analyzer installation guidance and gas connection.

### 6.1 User interface

The GPR-x800 (A)IS has a 1-inch LCD display and a four-key keypad interface.

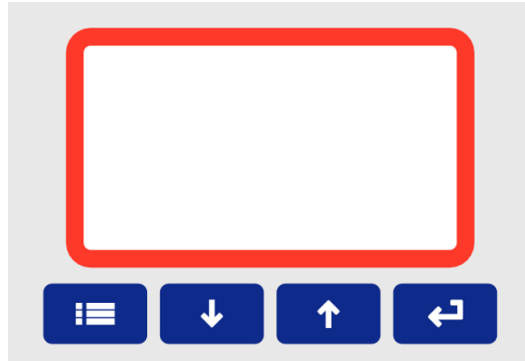





Figure 9. GPR-x800 (A)IS user interface

The interface keys can be used as identified in the table below:

Table 4: Interface key functions

Key	Function
	Menu open/close
	Enter
	Next (increment)
	Previous (decrement)

## 6.2 Initial start-up and self-test

Once the analyzer is correctly installed and power applied the analyzer will immediately start up. The digital display responds instantaneously and will display an initial start-up screen:

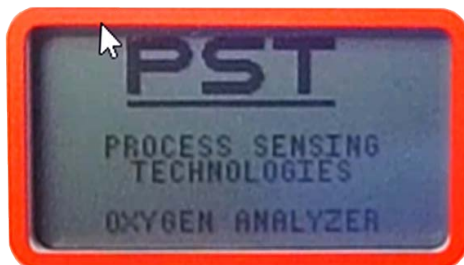
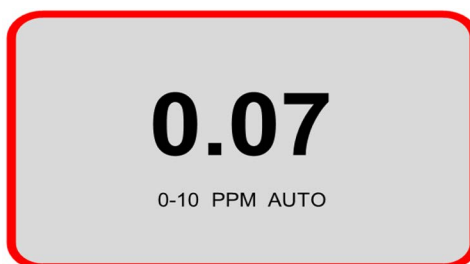

*Figure 10. GPR-series analyzer start-up screen*

After self-diagnostic tests, the analyzer switches to sampling mode and displays the oxygen reading from the sensor (larger size numeric value) and the measurement range (small size font with units)

**Auto** indicates that the analyzer is in AUTO mode. In this mode, the measured value affects the range, which will automatically adjust to the next higher level. See **Range** (page 23) in the **Main Menu** to select.

If the **Auto** is not selected, the range display will not show **Auto**. An example of a sampling mode screen is shown below in [Figure 11](#)



*Figure 11. Measurement mode display*

## 6.3 Menus

NOTE: Available menu options and sequences will vary between analyzer model and sensor type.



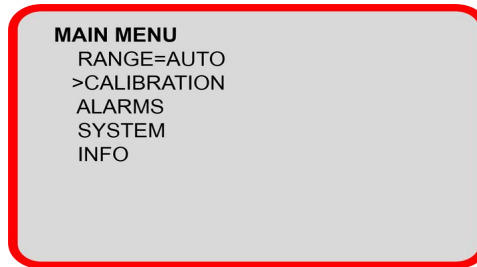

### 6.3.1 Main Menu and interface keys

To access the Main Menu, press the **Menu** key and the following Main Menu display will appear:



*Figure 12. Main menu display*

This screen shows the menu options available.

- Use the  and  keys to move the cursor to the desired menu
- Press  to access the sub menu
- Use the  key to return to the previous screen

#### **Range**

Configure analyzer measurement range (see "6.3.2 Range selection").

#### **Calibration**

Perform zero, span or analog calibration functions (see "Zero and span vs span calibration" on page 25).

#### **System**

Configure system-level settings.

#### **Info**

View analyzer information.

### 6.3.2 Range selection

Within the Range menu, you can select 6 options. The range is linked to the display and the 4...20 mA analog output of the analyzer.

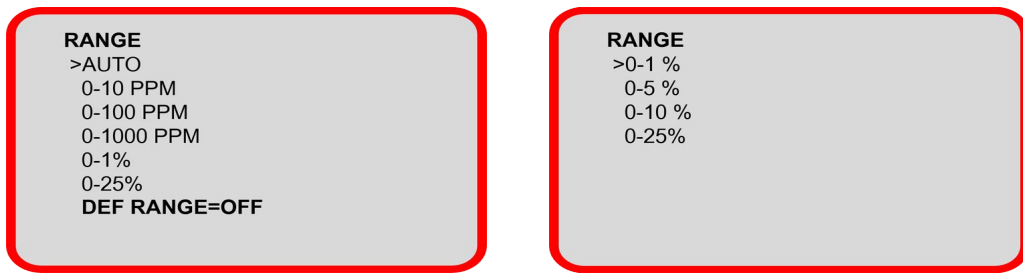

Figure 13. GPR-1800 (A)IS Range displays



**NOTE:** For trace oxygen analyzers, the range 0...25 % is for calibration purposes only. It is not a measurement range of the analyzer (see "Zero and span vs span calibration" on page 25 for calibration). Using this range extensively can significantly shorten the sensor life.

#### Range menu options

In the Range menu:

1. Use  and  to move the cursor to the desired range option.

2. Once the cursor is pointing to your chosen range, press  to select the range.

Selecting a range will cause the **Auto** option to change to **Fixed**. To select Auto, use  to move the cursor to **Fixed**, then press  to toggle between **Auto** and **Fixed**.

#### Auto

Selecting **Auto** will enable automatic adjustment of your measurement range depending on the oxygen levels detected by your oxygen sensor. For example, a 0...10 ppm range will change to 0...100 ppm if the measured oxygen value is higher than 10 ppm.

#### Default Range

This option will prevent incorrect range-setting if multiple users have access to the analyzer.

If the analyzer range has been changed, for instance for the purpose of checks or maintenance, and a default range has been pre-set, the analyzer will automatically return to the default range after 30 minutes of inactivity.

**Def Range** allows you to set the default range for the analyzer. Within this sub-menu, all standard ranges or **Auto** mode can be selected.

It is recommended that you set your preferred default range for the analyzer.

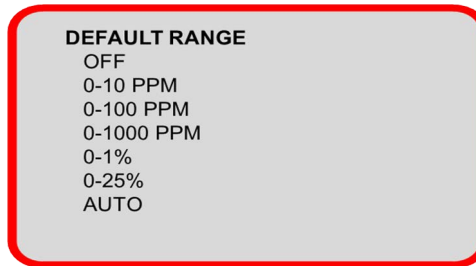

Figure 14. Default Range display

**Measurements outside manual range**

If the oxygen reading goes above the manual or auto range maximum value, the values will be displayed up to 10% above the maximum range. Beyond this, an OVER RANGE warning will be displayed.

**6.3.3 Analyzer calibration**

All electrochemical sensor-based analyzers require periodic calibration. The electrochemical sensor signal will remain relatively constant throughout its useful life, however, some components in a gas stream, e.g. sulfides, can adversely affect the sensor causing changes in sensitivity with time. As such, regular calibration is recommended to ensure accuracy and ascertain the integrity of the sensor (e.g. weekly intervals to a 3-month maximum).

Always use good calibration practices.

- Calibrate the analyzer at or close to the temperature and pressure of the sample gas.
- Use known reference gases or fresh air.
- Allow suitable stability time especially when making significant changes in measurement value (e.g. 20.9 % to 0.0 %). See table

Table 5: Example stability times

Condition example	Typical stability time
<1 % to air (20.9 %)	<3 minutes
Air (20.9 %) to 0.1%	<30 seconds
Air (20.9 %) to 0.01%	<2 minutes
2 minute air exposure to 10 ppm	60 minutes

**Set sensor serial**

Updating the sensor serial number is critical for the calibration process.

When replacing O<sub>2</sub> sensors it is important to update the sensor serial number. To view the current 9-digit sensor serial number, enter the **Calibration** menu.



The sensor serial number can be seen in the menu as shown below:



Figure 15. Calibration display

To change the sensor serial number:

1. Use  to select **Sensor SN=00000000**.  
The display will change as shown below in [Figure 16](#)

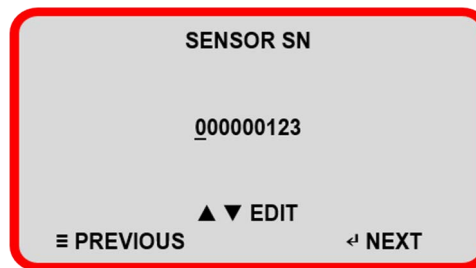







Figure 16. Sensor serial number display

2. Enter your sensor serial number by using  or  to edit the value.
3. Press  to progress to the next digit or  to move to the previous digit.
4. When you have entered your sensor serial number's last digit, press  to **Accept** the new serial number.

### Zero and span vs span calibration

Electrochemical oxygen sensors generate an electrical current that is linear or proportional to the oxygen concentration in a sample gas. In the absence of oxygen the sensor exhibits an absolute zero, i.e. the sensor does not generate a current output in the absence of oxygen. Given the properties of linearity and an absolute zero, a single point calibration is possible.

Zero calibration is recommended only when the application demands optimum accuracy of better than 5 % of the lowest range of the analyzer (e.g. for an analyzer configured for 0...25 % range, we would recommend a zero calibration if measurements below 1.0 % O<sub>2</sub> were required).

Span calibration is required routinely for accurate measurements of oxygen.

**NOTE: Zero calibration should always be carried out before a span calibration.**

### Span calibration

To perform a Span Calibration, enter the **Calibration** menu and select **Span Calibration**.

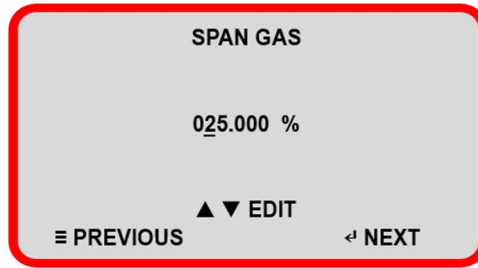

Figure 17. Span gas display

In the sub-menu, set the Span Gas value. If using certified cylinder gas, this can be found on the certificate that was supplied with the cylinder:

1. Use to progress to the next digit or to move to the previous digit; use and to edit the values.

**NOTE:** When a Span or Zero Cal starts, only "Abort" with is shown until the reading is stable, then "Accept" with appears.

2. Now select the unit in use (% or ppm).
3. When you press , the analyzer will switch to the appropriate range and display the live readings.

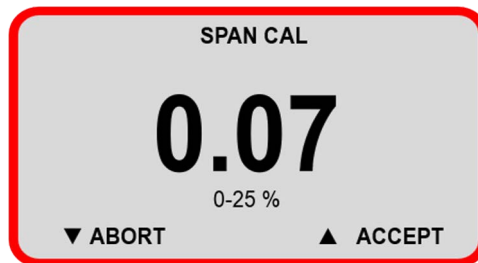

Figure 18. Span calibration display

Once gas readings are stable you can **Accept** or **Abort** the calibration. The calibration will **Pass** or **Fail** and the analyzer will return to normal operation at the configured range.

During calibration ensure stability of readings, secure gas connections and supply of suitable reference gas.

**NOTE:** If using a ppm sensor we do not recommend exposure of the sensor to ambient air as it will significantly degrade the sensor life.

## Zero calibration

The zero calibration adjustments are limited to 50 % of the most sensitive range. All analyzers are QC-tested to confirm the zero calibration. Should you observe a zero calibration error more than 50 % of the lowest range, we recommend first:

- Check the sample system for any possible leaks
- Confirm the integrity of the zero gas
- Ensure the analyzer has been given enough time to stabilize on the zero gas
- Ensure CLIP = OFF. Refer to " Clipping" on page 30 for information.

If adequate time is not allowed for the analyzer to establish the true baseline and a ZERO calibration is performed, the analyzer will likely display a negative reading in the sample mode when exposed to zero gas. If a negative reading is observed, we recommend repeating the ZERO calibration.

To perform a zero calibration:

1. Enter the **Calibration** menu and select **Zero Calibrate**.  
The analyzer will switch to **Zero Cal** mode and display the live readings.



*Figure 19. Zero calibration display*

2. Once gas readings are stable you can **Accept** or **Abort** the calibration.  
The calibration will **Pass** or **Fail** and the analyzer will return to normal operation at the configured range.

During calibration ensure stability of readings, secure gas connections and supply of suitable reference gas.

### Calibration log

The Cal Log shows a summary of events on the analyzer. A total 256 records can be recorded.

Details included are shown below;

Date	Cal Type	Correction Value	Pass/Fail		
01/01/23	RST			ZRO	= Zero calibration
01/01/23	SPN	-0.05	P	SPN	= Span calibration
01/01/23	ZRO	-1.00	F	RST	= Reset calibration to factory calibration

**NOTE:** The correction value does not relate to actual readings it is a proportional value. This value can be used by the PST-Aii Factory for diagnostics.

### 6.3.4 Alarms

This menu can be used to configure settings for one or both of the alarms.

**ALARMS**  
ALARMS ON / OFF  
**ALARM 1**  
**ALARM 2**  
LATCH VALVE  
TONE ON / OFF

**ALARM 1**  
ON / OFF  
SETPOINT  
MODE  
DELAY  
LATCHING  
FAILSAFE

**ALARM 2**  
ON / OFF  
SETPOINT  
MODE  
DELAY  
LATCHING  
FAILSAFE

Figure 20. Alarms displays

**On/Off**

Enable/disable both alarms (master enable).

**Setpoint**

Define the alarm trigger point.

**Mode**

Define alarm mode as high or low.

**Delay**

Define the alarm activation delay.

**Latching**

Define the alarm as latching or non-latching.

**Failsafe**

Define alarm relays as failsafe or non-failsafe.

**6.3.5 System**

Use the System menu to make the system adjustments shown in [Figure 21](#).

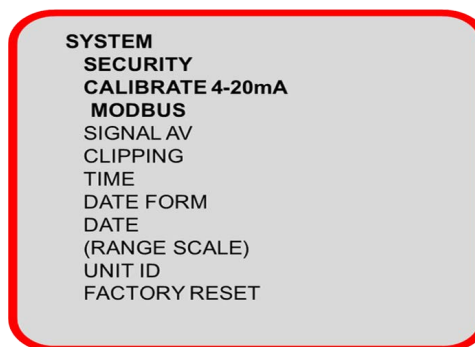

Figure 21. System display

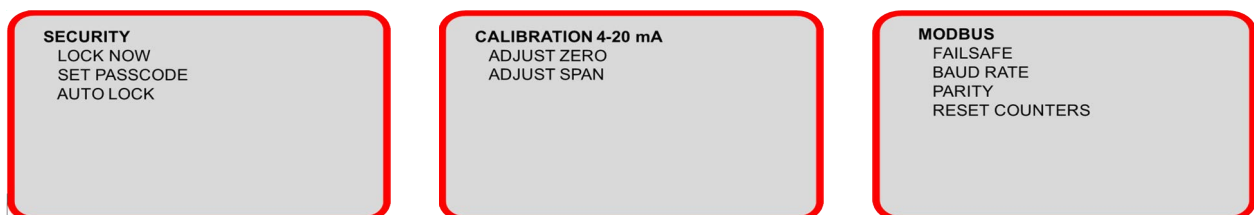

Figure 22. System sub-menu displays

## Security

- Enable Screen Lock with a passcode (default code is 0000)
- Set Passcode > Set the 4-digit passcode
- Enable Auto Lock > Locks the screen after 30 minutes

## Calibrate 4...20 mA

This sub-menu allows a direct offset to be applied to the 4...20 mA analog output.

1. Use the keypad to adjust the reference corrections for both 4 and 20 mA outputs.
2. Select **Accept** to apply the adjustments or **Abort**.

## Modbus

Please refer to "Appendix F - Modbus register (AIS only)" on page 52 for details.

## Signal AV - signal average

This function enables the setup of a measurement rolling average. A value between 1...100 readings can be used in a simple average calculation for the display measurements. Measurements are made at 1 Hz so that a value of 60 will give a 1-minute rolling average.

Higher signal average will help remove measurement instability but will reduce measurement response.

## Clipping

Enabling Clipping will stop the analyzer displaying below 0 ppm / 0 % readings.

## Time

Sets the on board 24-hour clock for data logging.

## Date form

This user-configurable functions enables you to set your date format preference to one of the following:

mm/dd/yy  
dd/mm/yy  
yy/mm/dd

## Date

Set the on board device date (after a full power cycle the date time will be 00:00 1 Jan 2000).

### Range scale

Adjusts the ppm range max value by a multiple (0-5)

For example setting Range Scale to 5 will give the following Range Options in the **Range** menu:

- 0-50 ppm
- 0-500 ppm
- 0-5000 ppm

Your analyzer is supplied with a Range scale of 1 as standard. This will generate ranges of:

- 0-10 ppm
- 0-100 ppm
- 0-1000

**NOTE:** Range scale only applies to the lowest three ranges of group 1 O<sub>2</sub> (10, 100, 1000 ppm O<sub>2</sub>).

### Unit ID

Allows an Alpha numeric ID to be given to the analyzer. This value will be stamped on log files and displayed on the INFO SCREEN.

### Factory reset

Reverts all settings to Factory Configuration including security settings, sensor calibration and analog calibration.

## 6.3.6 Info

The **Info** menu displays the device information including:

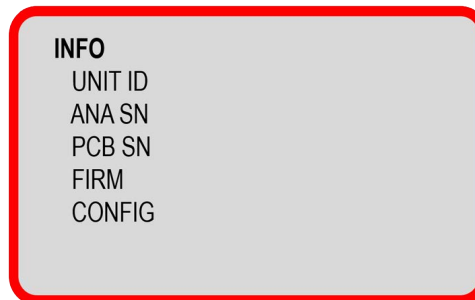

*Figure 23. Info display*

- **UNIT ID:** User defined (this is left blank for user, usually a location ID or asset number is entered here)
- **ANA SN:** Serial number of the analyzer (The 9-digit analyzer serial number is also displayed in log files)
- **PCB SN:** Serial number of the circuit board (a 9-digit number)
- **FIRM:** Firmware part number and revision
- **CONFIG:** This number refers to your analyzer's power, gas and Factory group number.

## 7 Maintenance

The GPR-x800 (A)IS will provide reliable and fault-free service with regular maintenance and calibration.

During periods without use the sensor should be purged with nitrogen or argon gas to preserve the sensor life.

 **Do not attempt to make repairs to the analyzer. This will void the warranty and may result in electrical shock, injury, or damage. All servicing should be referred to qualified service personnel.**

### 7.1 Sensor replacement

To maintain performance, the sensor in your GPR-x800 (A)IS analyzer will require replacement. Sensor life is application dependent.

When your sensor reaches the end of its serviceable life, calibration can no longer be performed and the sensor must be replaced.

A regular program of calibration will mitigate against sudden sensor failure. It is advisable to establish a program of preventative maintenance to ensure process downtime is kept to a minimum or avoided.

The protective plugs on your sensor should only be removed when your GPR-x800 (A)IS is installed and ready to begin gas measurement.

Refer to "5 Before connecting gas" on page 15 for the sensor installation procedure.

### 7.2 Routine cleaning

During sensor replacement, it is recommended that light cleaning of electrical contacts is carried out.

 **Never use chemical cleaning agents, solvents or high pressure water or steam to clean the equipment. Do not submerge in water.**

To perform routine cleaning:

1. Use a clean cloth that is damp with water to wipe away dust and dirt from the outside of the unit.
2. Dry the analyzer with a clean, dry cloth.



### 7.3 Routine inspection of sensor housing

The maximum interval between routine inspections should be determined with consideration of the application and importance of the measurement.

The interval should be reassessed on a regular basis and can be extended and reduced as the process control requires.

This can be carried out during sensor replacement. To perform routine inspection:

1. Ensure the gas entry and vent ports on the sensor housing are not obstructed.
2. Inspect the sensor housing seal and replace it if damage is visible.

### 7.4 Troubleshooting

- Ensure the correct calibration gas is used when performing a validation or calibration of your analyzer. This will prevent unpredictable operation and incorrect readings.
- The calibration gas should be within range of your GPR-x800 (A)IS, typically 100 ppm for the 0...1 % range analyzer, and 20.9 % for the 0...25 %. See the PST-Aii Factory calibration certificate supplied with your module for specific calibration gas values.
- A faulty sensor or one that is incorrectly installed will display 'FLT' on your analyzer's display.
- Do not expose the sensor to moisture in an unpowered state. If this happens, allow the sensor to dry out, and if necessary, apply clean dry inert gas:

**Table 6: Troubleshooting causes and recommendations**

Symptoms	Possible cause	Recommended actions
Slow recovery	At installation, defective sensor	Replace sensor if recovery unacceptable or O <sub>2</sub> reading fails to reach 10 % of lowest range
	Air leak in sample system connection(s)	Leak test the entire sample system: Vary the flow rate, if the O <sub>2</sub> reading changes inversely with the change in flow rate indicates an air leak - correct source of leak
	Abnormality in zero gas	Qualify with zero gas Replace sensor
	Damaged in service - prolonged exposure to air, electrolyte leak	Replace sensor
	Sensor nearing end of life	Replace sensor
High O <sub>2</sub> reading after installing or replacing sensor	Analyzer calibrated before sensor stabilized caused by:	
	Prolonged exposure to ambient air, worse if sensor was left in air un-shorted	Allow O <sub>2</sub> reading to stabilize before making any calibration adjustment, continue purge with zero gas
	Air leak in sample system connection(s)	Leak test the entire sample system (above)
	Abnormality in zero gas	Qualify with zero gas
High O <sub>2</sub> reading sampling	Flow rate exceeds limits Pressurized sensor	Correct pressure and flow rate Remove restriction on vent line or open SHUT OFF valve completely
	Improper sensor selection	Replace GPR/PSR sensor with XLT sensor when CO <sub>2</sub> or acid gases are present. Replace GPR/PSR sensor with -H sensor when H <sub>2</sub> or He gas is the background gas.
	Abnormality in sample gas measurement	Validate with portable oxygen analyzer
Response time slow	Air leak, dead legs, longer distance of sample line, low flow rate, high volume of optional filters and scrubbers	Leak test sample system bringing sample gas to analyzer, reduce dead volume and/or increase sample flow rate
O <sub>2</sub> reading doesn't agree with expected O <sub>2</sub> values	Pressure and temperature of the sample may be different than the span gas used for calibration Abnormality in the sample gas	Calibrate the analyzer (calibrate close to the pressure and temperature of the sample gas)
		Qualify sample gas independently

Symptoms	Possible cause	Recommended actions
Erratic O <sub>2</sub> reading or No O <sub>2</sub> reading	Test sensor signal output independent from analyzer	Remove sensor from housing. Using a voltmeter set to uA output; apply the (+) lead to the outer ring of the sensor PCB and the (-) lead to the center circle to obtain the sensor's output in air. If no current signal, replace sensor, otherwise contact the PST-Aii Factory.
	Abrupt changes in sample pressure	Regulate sample gas pressure and flow.
	Dirty electrical contacts in upper section of sensor housing	Replace sensor
	Corroded solder joints on sensor PCB from corrosive sample or electrolyte leakage from sensor Corroded spring loaded contact in upper section of sensor housing from liquid in sample or electrolyte leakage from sensor	Clean spring loaded contacts in upper section of sensor housing with a damp cloth or cotton swab, water or IPA can be used. If electrolyte leakage from sensor is evident, replace sensor
	Liquid in sensor housing	Wipe sensor and sensor housing with a damp cloth or cotton swab. Water or IPA can be used.
	Improper sensor selection	Replace GPR/PSR series sensor with XLT sensor when CO <sub>2</sub> or acid gases are present
	Presence of other interference gases	Consult PST-Aii Factory
	Presence of sulfur gases	Replace sensor and install H <sub>2</sub> S scrubber
	Unauthorized maintenance	Replace sensor, obtain authorized service
Erratic O <sub>2</sub> reading or Negative O <sub>2</sub> reading or No O <sub>2</sub> reading possibly accompanied by electrolyte leakage	Sensor nearing end of life	Replace sensor,
	Pressurizing the sensor by flowing gas to the sensor with the vent restricted	Zero the analyzer. If not successful replace the sensor
	Pressurizing the sensor by flowing gas to the sensor with SHUT OFF valve closed and then suddenly removing the restriction draws a vacuum on the sensor or partially opening the valves upstream of the analyzer when using a pump downstream of the analyzer to draw sample from a process at atmospheric pressure or a slight vacuum  A pressurized sensor may not leak but still can produce negative readings.  Placing a vacuum on the sensor in excess 40" of water column is strongly discouraged.	Avoid drawing a vacuum on the sensor
	A premature ZERO OFFSET of analyzer	From MAIN MENU select DEFAULT ZERO and perform a zero calibration

## 7.5 Spare parts

Recommended spare parts for the GPR-series of oxygen analyzers:

**Table 7: Spare part items**

Item no.	Description
GPR-12-333	ppm oxygen sensor
GPR-12-333-LD	ppm oxygen sensor for analyzer with liquid drain system
GPR-12-333-H	ppm oxygen sensor for He and H <sub>2</sub> gases
XLT-12-333	ppm oxygen sensor for gases with < 0.5 % CO <sub>2</sub> presence
XLT-12-333-LD	ppm oxygen sensor for gases with < 0.5 % CO <sub>2</sub> presence and analyzer with liquid drain system
GPR-11-60	% oxygen sensor
GPR-11-60-LD	% oxygen sensor for analyzer with liquid drain system
XLT-11-24	% oxygen sensor for gases with < 0.5 % CO <sub>2</sub> presence
XLT-11-24-LD	% oxygen sensor for gases with < 0.5 % CO <sub>2</sub> presence and analyzer with liquid drain system
B-2762-A-3-18	Housing sensor top assembly stainless steel
CHEM-1008-2	H <sub>2</sub> S scrubber material (sampling system only, not LD)
FLTR-1037	Coalescing filter element (sampling system only, not LD)
ORNG-1007	O-ring 3/32 x 1-3/8 x 1-9/16 Viton

## 8 Warranty information

The design and manufacture of Analytical Industries Inc. oxygen analyzers and oxygen sensors are performed under a certified Quality Assurance System that conforms to established standards and incorporates state of the art materials and components for superior performance and minimal cost of ownership.

Prior to shipment every analyzer is thoroughly tested by the manufacturer and documented in the form of a Quality Control Certification that is included in the Owner's Manual accompanying every analyzer.

When operated and maintained in accordance with the Owner's Manual, the units will provide many years of reliable service.

### 8.1 Coverage

Under normal operating conditions, the analyzers and sensors are warranted to be free of defects in materials and workmanship for the period specified in accordance with the most recent published specifications, said period begins with the date of shipment by the manufacturer.

The manufacturer information and serial number of this analyzer are located on the rear of the analyzer. Analytical Industries Inc. reserves the right in its sole discretion to invalidate this warranty if the serial number does not appear on the analyzer.

If your Analytical Industries Inc. monitor, analyzer and/or oxygen sensor is determined to be defective with respect to material and/or workmanship, Aii will repair it or, at our option, replace it at no charge to you.

This warranty applies to all monitors, analyzers and sensors purchased worldwide.

### 8.2 Limitations

Analytical Industries Inc. will not pay for: loss of time; inconvenience; loss of use of your Analytical Industries Inc. analyzer or property damage caused by your Analytical Industries Inc. analyzer or its failure to work; any special, incidental or consequential damages; or any damage resulting from alterations, misuse or abuse; lack of proper maintenance; unauthorized repair or modification of the analyzer; affixing of any attachment not provided with the analyzer or other failure to follow the user manual.

**US Customers only:** Some states and provinces do not allow limitations on the duration of an implied warranty or the exclusion or limitation of special, incidental or consequential damages, in this case, these exclusions may not apply. This warranty gives you specific legal rights. You may have other rights, which vary between states and provinces.

### 8.3 Exclusions

This warranty does not cover installation; defects resulting from accidents; damage while in transit to our service location; damage resulting from alterations, misuse or abuse; lack of proper maintenance;

unauthorized repair or modification of the analyzer; affixing of any label or attachment not provided with the analyzer; fire, flood, or acts of God; or other failure to follow the Owner's Manual.

## 8.4 Service

For queries related to service and warranty, please contact your local Process Sensing Technologies office, sales partner or supplier.

Offices are listed at [ProcessSensing.com](https://ProcessSensing.com) or email [oxygen@processsensing.com](mailto:oxygen@processsensing.com).



## 9 Appendices

### Appendix A - Technical Specifications

Sensor				
Electrochemical	ppm		%	
Model Number	GPR-12-333, GPR-12-333-LD GPR-12-33-H	XLT-12-333 XLT-12-333-LD	GPR-11-60 GPR-11-60-LD	XLT-11-24 XLT-11-24-LD
Measuring Range	0...10, 0...100, 0...1000 ppm <sub>v</sub> , 0...1 % 0...25 % (calibration only)		0...1, 0...5, 0...10, 0...25 %	
Output Resolution	0.01 ppm <sub>v</sub>		0.001 %	
Lower Detection Limit (LDL)	0.05 ppm <sub>v</sub>		0.01 %	
Sample Flow Rate (application dependent)	1...2 SCFH (0.5...1 LPM)			
Pressure Range	5...30 psi			
Response Time (T <sub>90</sub> )	< 2 minutes		< 30 seconds	
Operating Temperature Range	+5 °C...+45 °C (+41 °F...+113 °F)	-10 °C...45 °C (+14 °F...113 °F)	+5 °C...+45 °C (+41 °F...+113 °F)	-10 °C...45 °C (+14 °F...113 °F)
Life Expectancy (application dependent)	24 months in 1000 ppm <sub>v</sub>		60 months in air	24 months in air
Calibration Interval (application dependent)	30 days			
Analyzer				
Electrical				
Display	LCD			
Output Signal	4...20 mA			
Digital Communications	Modbus (AIS only)			
Relay Output Options	Two user configurable alarms (AIS only)			
Power Supply	18...24 V DC (IS) loop-powered 12...24 V DC (AIS) line-powered			
Maximum Power Consumption	1 W (IS) 28 W (AIS)			
Mechanical				
Ingress Protection	NEMA 3R			
Analyzer Housing Material	Fiberglass and painted aluminum			
Mounting	Wall / vertical surface			
Compliance				
Complies with EMC Directive: 2014/30/EU				

## Appendix B - Hazardous Area Certification

Region	Certification details	Standards
Europe	 <p><b>ATEX / UKCA</b>                      II 2 G Ex db ia IIC T4 Gb                      T<sub>amb</sub> (-20 °C...+50 °C)</p>	<p>EN 60079-0:2018                      EN 60079-1:2014                      EN 60079-11:2012</p>
North America/Canada	 <p><b>cMETus</b>                      Class I, Division 1, Groups B, C &amp; D, T4                      Class I, Zone 1, AEx db ia IIB+H2 T4 Gb, Ex db ia IIB+H2                      T4 Gb T<sub>amb</sub>                      (-20 °C...+50 °C)</p>	<p>UL 60079-0:2019 (R2020)                      UL 60079-1:2020                      UL 60079-11:2013 (R2018)                      UL 1203:2022                      UL 61010-1:2019</p> <p>CSA C22.2 No. 60079-0:2019                      CSA C22.2 NO. 60079-1:16 (R2021)                      CSA C22.2 No. 60079-11:2014 (R2018)                      CSA C22.2 NO. 30:20                      CSA C22.2 No. 61010-1:2017</p>
International	 <p><b>IECEx</b>                      Ex db ia IIC T4 Gb                      T<sub>amb</sub> (-20 °C...+50 °C)</p>	<p>IEC 60079-0:2017                      IEC 60079-1:2014                      IEC 60079-11:2011</p>



## Appendix C - Safety Data Sheet



**Analytical Industries Inc.**

A PST Brand

### Safety Data Sheet (KOH)

#### I. Product Identification

**Product Name:** Oxygen Sensor (Series AII, GPR, PSR, Private Label derivations)  
**Product Use:** Oxygen Sensors  
**Manufacturer:** Analytical Industries Inc.  
**Address:** 2855 Metropolitan Place, Pomona, CA 92767 USA  
**Contact Information:** Tel: 909-392-6900, Fax: 909-392-3665, email: info@aii1.com  
**Emergency Number:**

**Date Prepared:** January 1, 1995  
**Date Revised:** January 31, 2023

#### II. Hazardou(s) Identification

##### GHS Classification:

##### Lead (Pb)

##### Health

Acute Toxicity- Category (Inhalation)  
 Acute Toxicity- Category 4 (oral/dermal)  
 Carcinogenic- Category 2ty  
 Reproductive/Developmental- Category 2  
 Target organ Toxicity (Repeated) Category 2

##### Environmental

Acute Aquatic Toxicity-Cat  
 Chronic Aquatic Toxicity-Category 1

##### Physical

NA

##### Potassium Hydroxide (KOH)

##### Health

Corrosive to Metal- Category 1  
 Acute Toxicity- Category 4 (oral)  
 Skin Corrosion-Category 1A  
 Serious Eye Damage-Category 1

##### Environmental

Acute Aquatic Toxicity-Cat

##### Physical

NA

##### GHS Labels:

##### Potassium Hydroxide (KOH)

##### Symbols:



##### Hazardous Statements

- Danger
- May be corrosive to metal
- Harmful if swallowed
- Causes severe skin burns and eye damage
- Harmful to aquatic life

##### Precautionary Statements

- Wash skin thoroughly after handling.
- Do not eat, drink or smoke when using this product.
- Avoid release to the environment.
- Wear protective gloves/ protective clothing/ eye protection/ face protection.
- IF SWALLOWED: Call a POISON CENTER or doctor/ physician if you feel unwell.
- IF SWALLOWED: Rinse mouth. Do NOT induce vomiting.
- IF ON SKIN (or hair): Remove/Take off immediately all contaminated clothing. Rinse skin with water/ shower.
- IF INHALED: Remove victim to fresh air and keep at rest in a position comfortable for breathing.
- IF IN EYES: Rinse cautiously with water for several minutes. Remove contact lens if present and easy to do. Continue rinsing. Immediately call a POISON CENTER for doctor/ physician.
- Wash contaminated clothing before reuse.
- Absorb spillage to prevent material damage.
- Store in corrosive resistant stainless steel container with a resistant inner liner.
- Dispose of contents/ container to an approved waste disposal plant.

##### GHS Labels:

##### Lead (Pb)



**Analytical Industries Inc.**

A PST Brand

**Safety Data Sheet (KOH)**

**Symbols:**



**Hazardous Statements**

- Warning !
- Harmful if swallowed
- Suspected of causing cancer.
- Suspected of damaging fertility or the unborn child.
- May cause damage to organs through prolonged or repeated exposure.
- Very toxic to aquatic life with long lasting effects.

**Precautionary Statements**

- If breathed in, move person into fresh air. In not breathing, give artificial respiration. Consult a physician.
- In case of skin contact, wash off with soap and plenty of water.
- In case of eye contact, flush eyes with water as a precaution.
- If swallowed, rinse mouth with water.

**III. Composition /Information on Ingredients**

Material	C.A.S. #	Weight %	GHS Classification	Notes
<b>Lead (Pb)</b>	7439-92-1	50-75	Carc 1A;H350 Aquatic Acute 1:H400	Substance classified with a health & Environmental hazard. Substance with a work place limit
<b>Potassium Hydroxide (KOH)</b>	1310-58-3	1.0-10	Acute Tox. 4; H302 Skin Corr.1A; H314	Substance classified with a health & Environmental hazard. Substance with a work place limit.

**IV. First Aid Measures**

**4.1. Description of aid measures**

**General:**

- In all cases of doubt, or when symptoms persist, seek medical attention. Never give anything by mouth to an unconscious person.

**Inhalation:**

- Remove to fresh air, keep patient warm and at rest. If breathing is irregular or stopped, give artificial respiration. If unconscious place in the recovery position and obtain immediate

**Eyes:**

- Irrigate copiously with clean water for at least 15 minutes, holding the eyelids apart and seek medical attention.

**Skin:**

- Remove contaminated clothing. Wash skin thoroughly with soap and water or use a recognized skin cleanser.

**Ingestion:**

- Do NOT induce vomiting. Rinse mouth and slowly drink several glasses of water. Call a physician. Do NOT give anything by mouth to an unconscious or

**4.2. Most important symptoms and effects, both acute and delayed**

- The most important known symptoms and effects are described in the labelling (see section II) and/or in section XI

**V. Fire -Fighting Measures**

**5.1. Extinguishing media**

- Use standard fire fighting media on surrounding materials including water spray, foam, and carbon dioxide. (Do not use dry chemical extinguisher

**5.2. Special hazards arising from the substance or mixture**

- Lead Oxides.

**5.3. Advice for fire-fighters**

- Wear self-contained breathing apparatus for firefighting if necessary.



**Analytical Industries Inc.**

A PST Brand

**Safety Data Sheet (KOH)**

**5.4. Further Information**

- Gives off hydrogen by reaction with metals.

**VI. Accidental release measures**

**Note:** The Oxygen sensor contains a strong basic solution encapsulated in a plastic housing. Under normal operating conditions the solution (electrolyte) is never exposed. In case of a leak please observe the following instructions:

**6.1. Personal precautions, protective equipment and emergency procedures**

- Use appropriate personal protective equipment. Avoid dust formation. Avoid breathing vapors, mist or gas. Ensure adequate ventilation. Evacuate personnel to safe areas. Avoid breathing dust. For personal protection see section

**6.2. Environmental precautions**

- Do not allow spills to enter drains or waterways. Use good personal hygiene practices. Wash hands before eating, drinking, smoking or using toilet. Promptly remove soiled clothing and wash thoroughly before reuse.

**6.3. Methods and material for containment and cleaning up**

- Contain spillage. Neutralize spill with soda ash or lime. Carefully place material into clean dry contain and cover. Flush spill area with water. Avoid creating dust.

**VII. Handling and storage**

**7.1. Precautions for safe handling**

- Under normal circumstances the lead anode and potassium hydroxide electrolyte are sealed inside the oxygen sensor which is then sealed in a polyethylene bag and placed in a cardboard box for shipment) and do not present a health hazard. The following guidelines are provided in the event an oxygen sensor leaks
- Before opening the bag containing the sensor cell, check the sensor cell for leakage. If the sensor cell leaks, do not open the bag. If there is liquid around the cell while in the instrument, put on gloves and eye protection before removing the

**7.2. Conditions for safe storage, including any incompatibilities**

- Store sensors in a cool ,dry and well-ventilated places. Exercise due caution to prevent damage to or leakage from the container. Keep containers closed when

**7.3. Specific end use(s)**

- Apart from the uses mentioned in section I no other specifies are stipulated.

**VIII. Exposure Controls/Personal Protection**

**8.1. Control parameters**

**Exposure**

<u>CAS No.</u>	<u>Ingredient</u>	<u>Source</u>	<u>Value</u>
0001310-58-3	Potassium hydroxide	OSHA	No Establish Limits
		ACGIH	Ceiling: 2mg/m3
		NIOSH	Ceiling: 2mg/m3
007439-92-1	Lead (Pb)	Supplier	No Establish Limits
		OSHA	(1910.1025)TWA 0.050mg/m3
		ACGIH	TWA:0.05 mg/m3R,2B,2A
		NIOSH	TWA (8 Hour)0.050 mg/m3
	Supplier		No Establish Limits

**Carcinogen Data**

<u>CAS No.</u>	<u>Ingredient</u>	<u>Source</u>	<u>Value</u>
0001310-58-3	Potassium hydroxide	OSHA	Select Carcinogen: No
		NTP	Known: No; Suspected: No
		IARC	Group 1: No; Group 2a: No;
007439-92-1	Lead (Pb)	OSHA	Group 2b: No; Group 3: No;
			Group 4: No;
			Select Carcinogen: Yes



**Analytical Industries Inc.**

A PST Brand

**Safety Data Sheet (KOH)**

NTP Known: No; Suspected: Yes  
 Group 1: No; Group 2a: No;  
 IARC Group 2b: Yes; Group 3: No;  
 Group 4: No;

**8.2. Exposure controls  
Respiratory**

- If workers are exposed to concentrations above the exposure limit they must use the appropriate, certified respirators.

**Eyes**

- Chemical splash goggles

**Skin**

- Apron, face shield Wear gloves. Gloves must be resistant to corrosive materials. Nitrile or PVC gloves are suitable. Do not use cotton or leather gloves.

**Engineering Controls**

- Provide adequate ventilation. Where reasonably practicable this should be achieved by the use of local exhaust ventilation and good general extraction. If these are not sufficient to maintain concentrations of particulates and any vapor below occupational exposure limits suitable respiratory protection must be worn.

**Other Work Practices**

- Use good personal hygiene practices. Wash hands before eating, drinking, smoking or using toilet. Promptly remove soiled clothing and wash thoroughly

**IX. Physical / Chemical Characteristics**

**9.1 Information on basic physical and chemical properties**

Material / Component:

Lead (Pb) - Anode

Potassium Hydroxide (KOH) - Electrolyte

**Appearance**

Article Solid

**Form:** Liquid; **Color:** Clear Translucent

**Odor**

None

None

**Odor threshold**

Not Measured

Not Measured

**pH**

Not Measured

>13

**Melting point / freezing point**

>328° C

Not Measured

**Initial boiling point and boiling range**

>1320° C

Not Measured

**Flash Point**

Not Measured

>100° C

**Evaporation rate (Ether = 1)**

Not Measured

Not Measured

**Flammability (solid, gas)**

Not Applicable

Not Measured

**Upper/lower flammability or explosive limits**

Not Measured

Not Measured

**Vapor pressure**

Not Measured

Not Measured

**Vapor Density**

Not Measured

Not Measured

**Specific Gravity**

Not Measured

Not Measured

**Solubility in Water**

Insoluble

100% (Water based solution)

**Partition coefficient n-octanol/water (Log Kow)**

Not Measured

Not Measured

**Auto-ignition temperature**

Not Measured

Not Measured

**Decomposition temperature**

Not Measured

Not Measured

**Viscosity (cSt)**

Not Measured

Not Measured

**9.2. Other information**

No other relevant information.

**X. Stability and Reactivity**

**10.1. Reactivity**

- Hazardous Polymerization will not occur

**10.2. Chemical stability**

- Stable under normal circumstances

**10.3. Possibility of hazardous reactions**

- Incompatible with strong oxidizers, leather and halogenated compounds. Product will react with 'soft' metals such as aluminum, tin, magnesium, and zinc



**Analytical Industries Inc.**

A PST Brand

## Safety Data Sheet (KOH)

- releasing flammable hydrogen gas.
- 10.4. Conditions to avoid**
- Excessive heat and open flame.
- 10.5. Incompatible materials**
- Aluminum, organic materials, acid chlorides, acid anhydrides, magnesium, copper. Avoid contact with acids and hydrogen peroxide >52%
- 10.6. Hazardous decomposition products**
- Toxic fumes.

## XI. Toxicological Information

### 11.1 Information on toxicological effects (Potassium Hydroxide)

#### Acute toxicity

- LD50 Oral - Rat- 333mg/kg
- Inhalation : no data available
- Dermal: no data available

#### Skin Corrosion/irritation

- Skin Rabbit- Severe skin irritation 24 h

#### Serious eye damage/eye irritation

- Eyes Rabbit- Corrosive to eyes (OECD Test Guideline 405)

#### Respiratory or skin sensitization

- No Data Available

#### Germ cell mutagenicity

- No Data Available

#### Carcinogenicity

**IARC** • No component of this product presents at levels greater than or equal to 0.1% is identified as probable, possible or confirmed human carcinogen by IARC.

**ACGIH** • No component of this product presents at levels greater than or equal to 0.1% is identified as a carcinogen or potential carcinogen by ACGIH.

**NTP** • No component of this product presents at levels greater than or equal to 0.1% is identified as a known or anticipated carcinogen by NTP

**OSHA** • No component of this product presents at levels greater than or equal to 0.1% is identified as a carcinogen or potential carcinogen by OSHA

#### Reproductive toxicity

- No Data Available

#### Specific target organ toxicity-single exposure

- No Data Available

#### Specific target organ toxicity-repeated exposure

- No Data Available

#### Additional information

- RTECS:TT2100000

### 11.2 Information on toxicological effects (Lead)

#### Acute toxicity

- Inhalation : no data available
- Dermal: no data available

#### Skin Corrosion/irritation

- No Data Available

#### Serious eye damage/eye irritation

- No Data Available

#### Respiratory or skin sensitization

- No Data Available

#### Germ cell mutagenicity

- Rat - Cytogenetic analysis



**Analytical Industries Inc.**

A PST Brand

**Safety Data Sheet (KOH)**

- Carcinogenicity**
  - Limited evidence of carcinogenicity in animal studies
  - IARC** • 2B-Group 2B. Possibly carcinogenic to humans (Lead)
  - NTP** • Reasonably anticipated to be a human carcinogen (Lead)
  - OSHA** • 1910.1025 (Lead)
- Reproductive toxicity**
  - Suspected human reproductive toxicant
  - Rat-Inhalation: Effects on Newborn; Biochemical metabolic
  - Rat-Oral: Effects on Newborn; Behavioral
  - Mouse-Oral: Effect on Fertility: Female fertility index (e.g., # females pregnant per # sperm positive females; # females pregnant per # females mated). Effects on Fertility: Pre-implantation mortality (e.g., reduction in number of implants per female; total number of implants per corpora lutea).
- Development Toxicity**
  - Rat-Inhalation: Effects on Embryo or Fetus: Fetotoxicity (except death, e.g., stunted fetus). Specific Developmental Abnormalities: Blood and lymphatic system (including spleen and marrow).
  - Rat-Oral: Specific Developmental Abnormalities: Blood and lymphatic system (including spleen and marrow). Effects on Newborn: Growth statistics (e.g.,
  - Rat-Oral: Effects on Embryo or Fetus: Fetotoxicity (except death, e.g., stunted fetus). Effects on Embryo or Fetus: Fetal death.
  - Mouse-Oral: Effects on Embryo or Fetus: Fetotoxicity (except death, e.g., stunted fetus). Effects on Embryo or Fetus: Fetal death.
- Specific target organ toxicity – single exposure**
  - No Data Available
- Specific target organ toxicity – repeated exposure**
  - May cause damage to organs through prolonged or repeated exposure.
- Aspiration hazard**
  - No Data Available
- Additional Information**
  - RTECS: OF7525000

**XII. Ecological Information**

**12.1. Toxicity**  
 Very toxic to aquatic life  
**Aquatic Ecotoxicity**

Ingredient	96 hr. LC50 fish, mg/l	48 hr. EC50 crustacea, mg/l	ErC50 algae, mg/l
Lead Compounds (as Pb) - (7439-92-1)	0.44, Cyprinus carpio	4.40, Daphnia magna	0.25 (72 hr.), Scenedesmus subspicatus
Potassium hydroxide. - (1310-58-3)	Not Available	Not Available	Not Available

- 12.1. Persistence and degradability**
  - There is no data available on the preparation itself.
- 12.3. Bioaccumulative potential**
  - Not Measured
- 12.4. Mobility in soil**
  - No Data Available
- 12.5. Result of PBT and vPvB assessment**
  - This Product contains no PBT and vPvB chemicals.
- 12.6. Other adverse effects**
  - Lead is bioaccumulative in most aquatic life and mammals. It is highly mobile as lead dust or fume, yet forms complexes with organic material which limits its

**XIII. Disposal Considerations**



## Analytical Industries Inc.

A PST Brand

### Safety Data Sheet (KOH)

#### 13.1. Waste treatment methods

- Do not allow into drains or water courses. Wastes and emptied containers should be disposed of in accordance with regulations made under the Control of Pollution Act and the Environmental Protection Act.
- Using information provided in this data sheet advice should be obtained from the Waste Regulation Authority, whether the special waste regulations apply.

### XIV. Transport Information

#### DOT:

- Regulated. Refer to Small Quantity Exceptions: 49 CFR 173.4
- UN3266, Corrosive liquid, basic, inorganic, n.o.s., (potassium hydroxide, lead), 8, II NOTE: This description is used for shipping purposes when not using Analytical Industries Inc. US DOT Approval.
- UN3363, Dangerous Goods in Machinery or Dangerous Goods in Apparatus, 9. NOTE: This description is used when shipping under the US DOT Approval.

#### IATA:

- Regulated. Meets criteria for IATA Dangerous Goods in Excepted Quantities, Secti

#### Environmental hazards

#### IMDG

- Marine Pollutant: Yes ( Lead Compounds (as Pb) )

### XV. Regulatory Information

#### Regulatory Overview

- The regulatory data in Section 15 is not intended to be all-inclusive, only selected regulations are represented.

#### Toxic Substance Control Act ( TSCA)

- All components of this material are either listed or exempt from listing on the TSCA Inventory

#### WHMIS Classification

- D2A E

#### US EPA Tier II Hazards

**Fire:** No  
**Sudden Release of Pressure:** No  
**Reactive:** No  
**Immediate (Acute):** Yes  
**Delayed (Chronic):** Yes

#### EPCRA 311/312 Chemicals and RQs (lbs.):

- Lead Compounds (as Pb) ( 10.00)
- Potassium hydroxide. ( 1,000.00)

#### EPCRA 302 Extremely Hazardous :

- (No Product Ingredients Listed)

#### EPCRA 313 Toxic Chemicals:

- Lead Compounds (as Pb)

#### Proposition 65 - Carcinogens (>0.0%):

- Lead Compounds (as Pb)

#### Proposition 65 - Developmental Toxins (>0.0%):

- Lead Compounds (as Pb)

#### Proposition 65 - Female Repro Toxins (>0.0%):

- Lead Compounds (as Pb)

#### Proposition 65 - Male Repro Toxins (>0.0%):

- Lead Compounds (as Pb)

#### N.J. RTK Substances (>1%):

- Lead Compounds (as Pb)
- Potassium hydroxide.

### XVI. Other Information

The information and recommendations contained herein are based upon data believed to be correct. However, no guarantee or warranty of

***Analytical Industries Inc.***

A PST Brand

**Safety Data Sheet (KOH)**

any kind, expressed or implied, is made with respect to the information contained herein. We accept no responsibility and disclaim all liability for any harmful effects which may be caused by exposure to our products. Customers/users of this product must comply with all applicable health and safety laws, regulations, and orders.

H302 Harmful if swallowed.  
H314 Causes severe skin burns and eye damage.  
H350 May cause cancer.  
H400 Very toxic to aquatic life.

**This is the first version in the GHS SDS format. Listings of changes from previous versions in other formats are not**

All chemicals may pose unknown hazards and should be used with caution. While the information contained in this Material Safety Data Sheet is believed to be correct and is offered for your information, consideration and investigation, Analytical Industries Inc assumes no responsibility of the completeness or accuracy of the information contained herein.

End of Document



# Appendix D - Controlled drawings

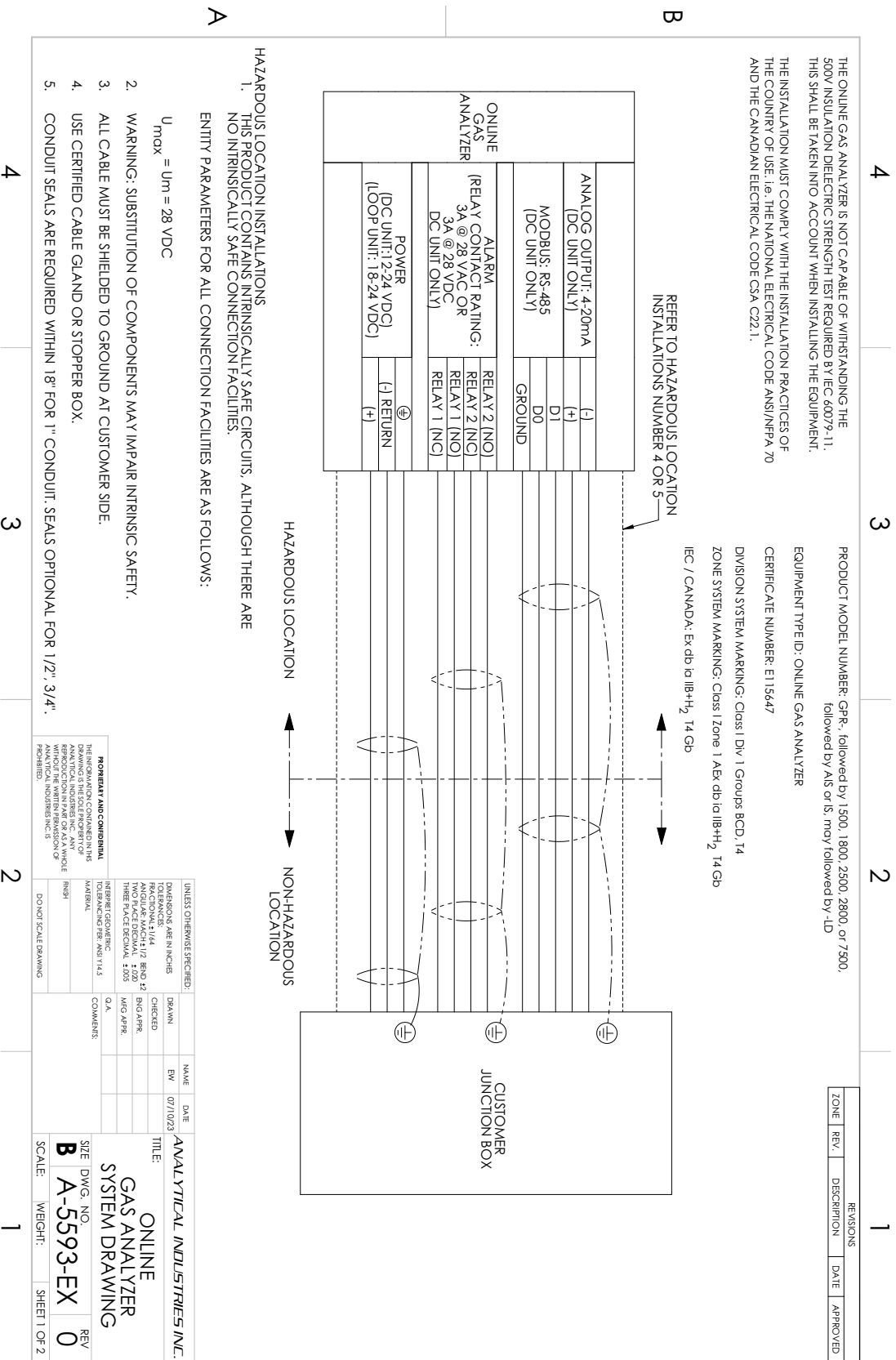

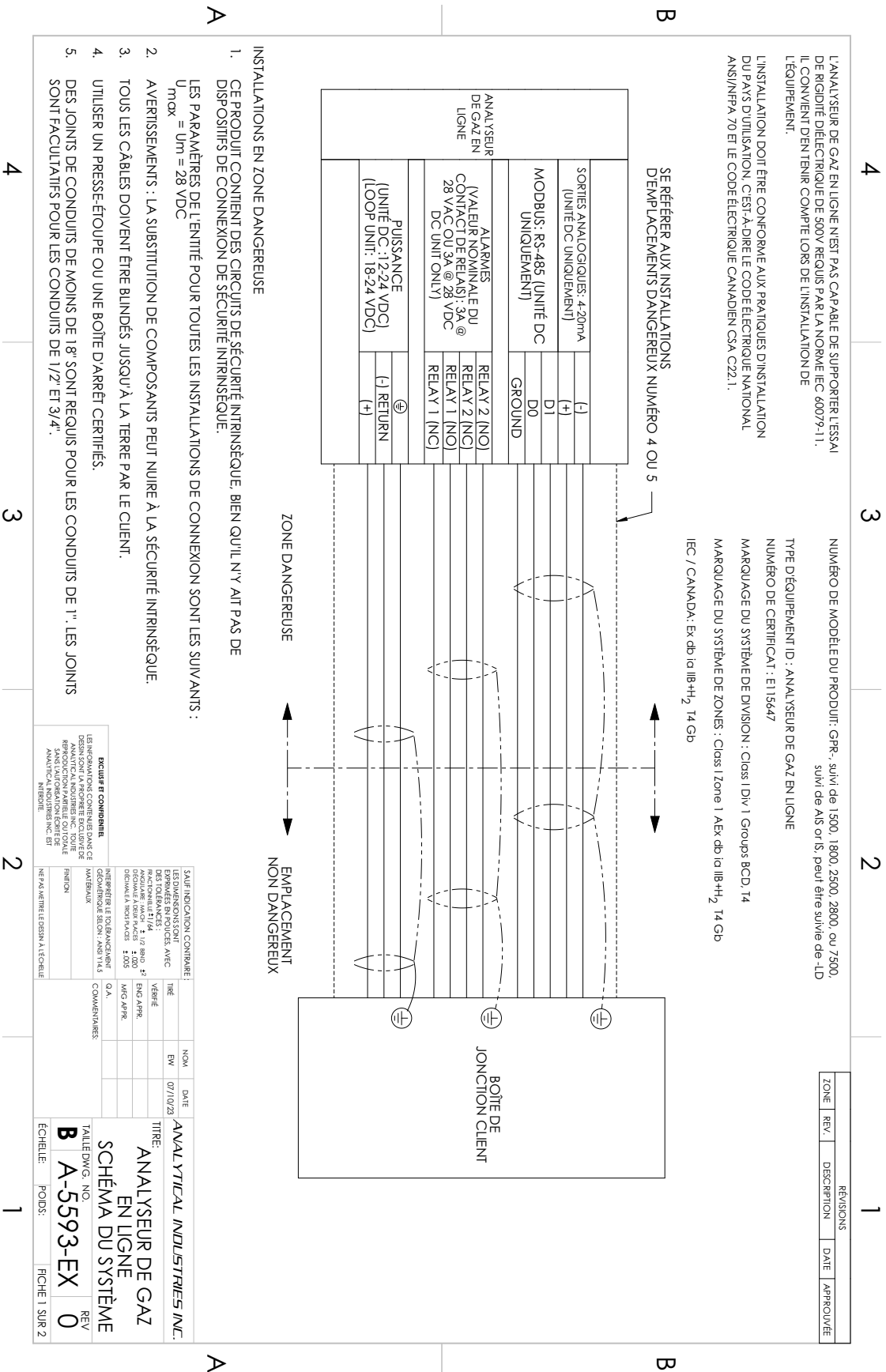

## Appendix E - Mounting information

### GPR-x800 (A)IS

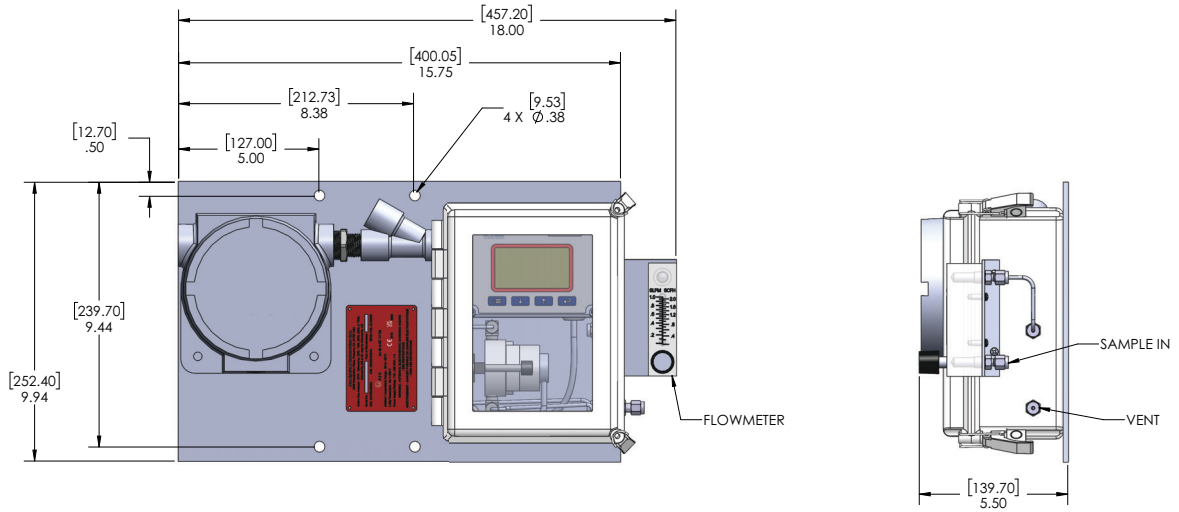

### GPR-x800 (A)IS-LD

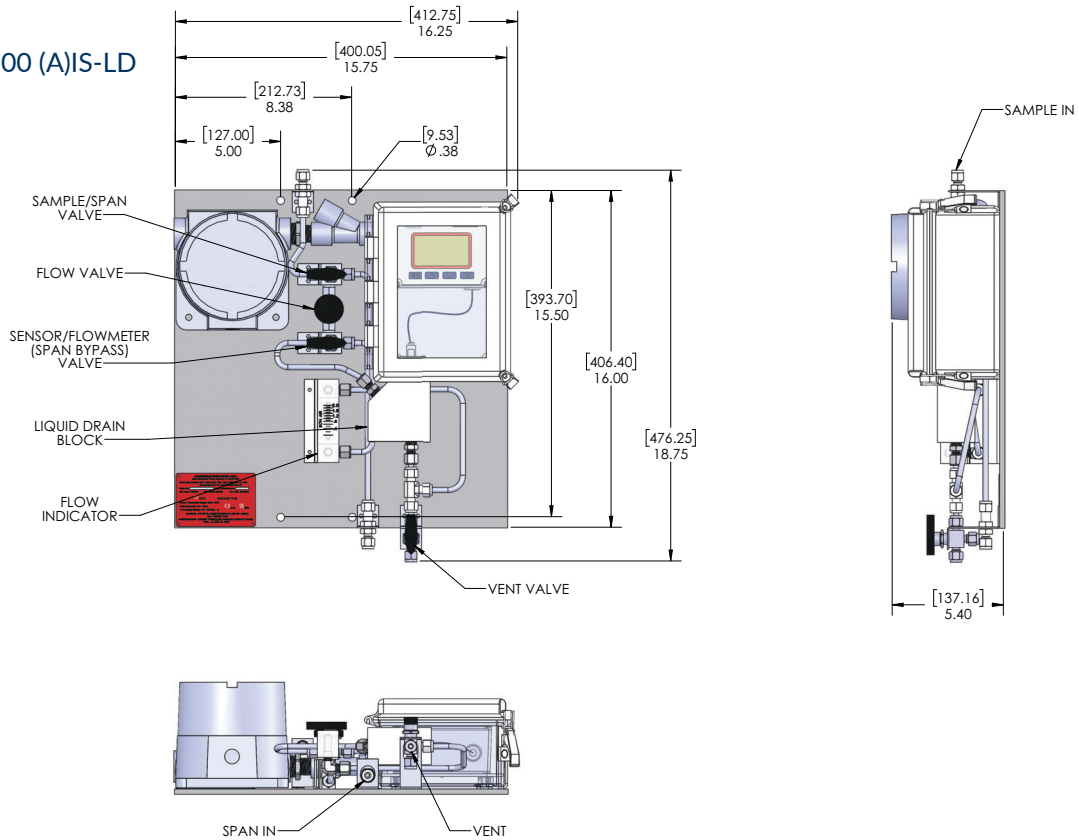

## Appendix F - Modbus register (AIS only)

### Modbus Register Map

ADDR	REG	DESCRIPTION	R/W	VALID VALUES	UNIT	SCALE	FORMAT	
0	1	Gas concentration, high word	R		(Note 1)		S-INT	Monitor
1	2	Gas concentration, low word						
2	3	Calibration in progress	R	0=no, 1=zero, 2=span			U-INT	
3	4	Range number	R/W	1-5			U-INT	
4	5	Range mode	R/W	0>manual, 1=auto			U-INT	
5	6	Temperature	R		C	x100	S-INT	
6	7	Error Code	R	(Note 2)			U-INT	
7	8	Alarm 1 status	R	0=inactive, 1=active			U-INT	
8	9	Alarm 2 status	R	0=inactive, 1=active			U-INT	
18	19	Analyzer S/N, high word	R	0-999999999			U-INT	Info
19	20	Analyzer S/N, low word						
20	21	Sensor S/N, high word	R	0-999999999			U-INT	
21	22	Sensor S/N, low word						
22	23	Restart Analyzer	W	255			U-INT	

Note 1: If lowest range is PPM, UNIT=PPM, SCALE=x100. If lowest range is %, UNIT=%, SCALE=x10

Note 2:

bit 0	gas concentration over range
bit 1	amp over range
bit 2	temperature out of range
bit 3	amp calibration error
bit 4	battery low
bit 5	date not set

### Modbus Specifications

**Addressing:** Slave, 1 to 247\*

**Broadcast:** No

**Baud Rate:** 9600, 28800, 57600, 115200, 230400 BPS

**Parity:** EVEN (1 stop bit), ODD (1 stop bit), NONE (2 stop bits)

**Mode:** RTU

**Electrical:** RS485 2-wire cabling (half-duplex), up to 256 devices without repeater

**Connector:** Screw Terminals

**Supported Functions:** Read Holding Registers (Function 3), Write Single Register (Function 6)

**Valid Register Addresses:** 0-22

**Response Rate:** <1 second (MODBUS master requests should be sent fewer than one request per second)

*\*It is imperative that each device on a network be assigned a unique address in order for the network to function properly.*

## Appendix G - Menu displays

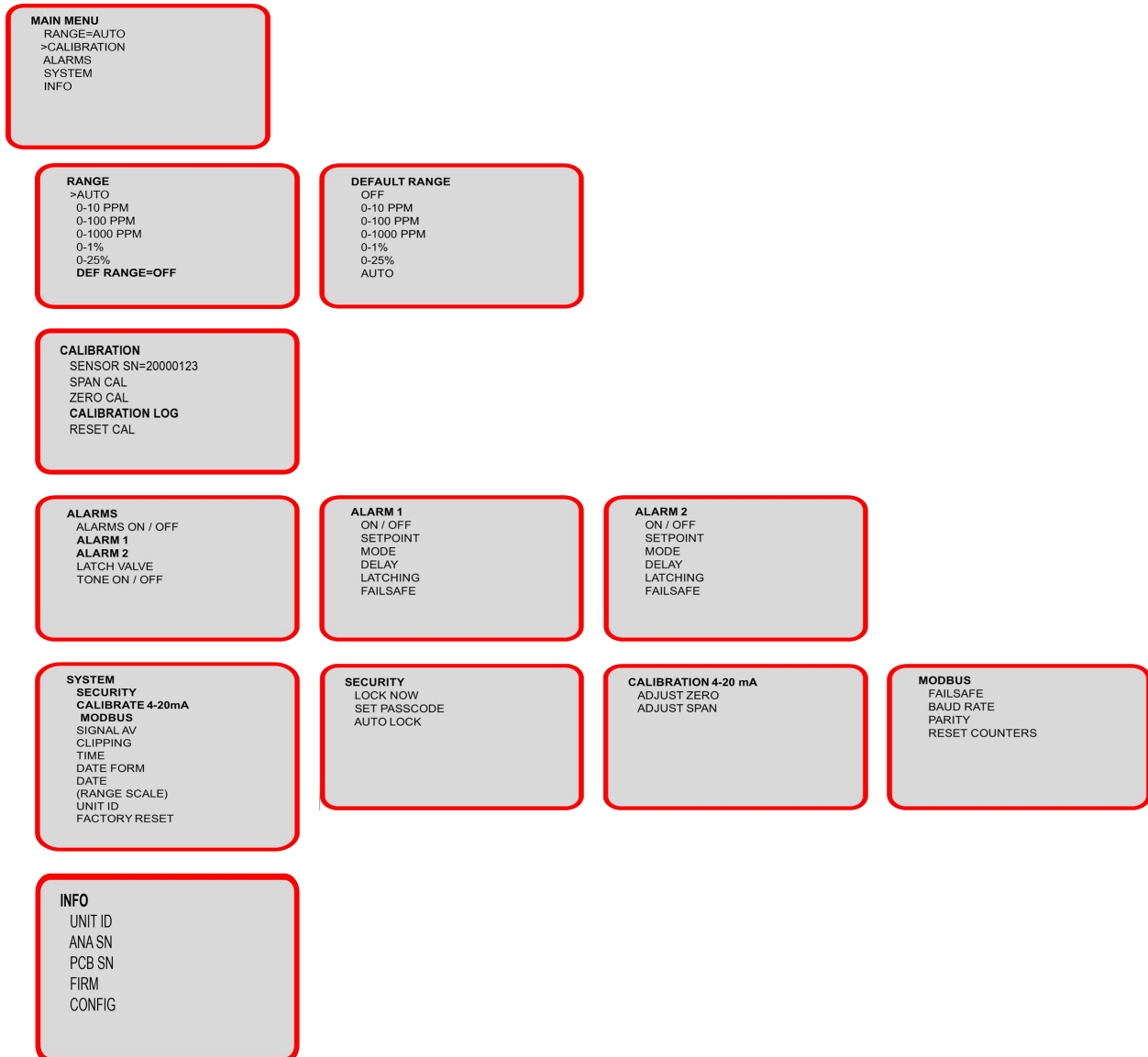

NOTE: The menu structure may vary depending on your configuration.

## Appendix H - Rating plates

**Analytical Industries Inc.**  
2855 Metropolitan Place, Pomona, CA, 91767 USA  
Online Gas Analyzer: GPR-, followed by 1500, 1800, 2500, 2800, or 7500,  
followed by AIS or IS, may be followed by -LD  
Serial No: [ ] Year of Manufacture: [ ]  
CML 22ATEX2595X      CML 22UKEX2594X      IECEx CML 22.0090X

 II 2 G      Ex db ia IIC T4 Gb

Ambient Temperature Range: -20 to +50°C  
Entity Parameters: Um = 250 V       2776       2503  
Power Supply Ratings: 110 - 220 VAC, 1 A

WARNING - POTENTIAL ELECTROSTATIC CHARGING HAZARD  
- SEE INSTRUCTIONS  
AVERTISSEMENT - DANGER POSSIBLE DE CHARGES ÉLECTROSTATIQUE  
- VOIR LES INSTRUCTIONS

**Analytical Industries Inc.**  
2855 Metropolitan Place, Pomona, CA, 91767 USA  
Online Gas Analyzer: GPR-, followed by 1500, 1800, 2500, 2800, or 7500,  
followed by AIS or IS, may be followed by -LD  
Serial No: [ ] Year of Manufacture: [ ]  
Class I Div 1 Groups BCD, T4  
Class I Zone 1 AEx db ia IIB+H<sub>2</sub> T4 Gb  
Ex db ia IIB+H<sub>2</sub> T4 Gb       Hazardous Location Safety E115647  
Ambient Temperature Range: -20 to +50°C  
Entity Parameters: U<sub>max</sub> = Um = 28 VDC

 REFERENCE DWG. A-5593-EX FOR INSTALLATION REQUIREMENTS  
RÉFÉRENCE DWG. A-5593-EX POUR LES EXIGENCES D'INSTALLATION  
WARNING - POTENTIAL ELECTROSTATIC CHARGING HAZARD  
- SEE INSTRUCTIONS  
AVERTISSEMENT - NE PAS CHARGER NI OUVRIR DANS UN  
EMPLACEMENT DANGEREUX

## Appendix I - Quality, recycling, and warranty information

Aii is part of the Process Sensing Technologies (PST) Group. The PST Oxygen group of companies - Aii, Ntron and SST - comply with applicable national and international standards and directives.

Full information can be found on this website

<https://www.processsensing.com/en-us/resources/compliance/>

The compliance site contains information on the following directives:

- ATEX (equipment for explosive atmosphere, Europe)
- CE
- cMETus (electrical equipment for hazardous areas, North America)
- IECEx
- REACH (Registration, Evaluation, Authorization, and Restriction of Chemicals)
- Recycling policy
- RoHS (Restriction of Hazardous Substances in electrical and electronic equipment)
- UKCA
- WEEE (Waste Electrical and Electronic Equipment recycling).



[ProcessSensing.com](http://ProcessSensing.com)

Analytical Industries Incorporated (Aii) is part of the Process Sensing Technologies Group

©2023 Process Sensing Technologies  
2855 Metropolitan Place, Pomona, CA 91767, USA

---