

DLM3022, DLM3032, DLM3052
Digital Oscilloscope
DLM3024, DLM3034, DLM3054
Mixed Signal Oscilloscope

U S E R ' S M A N U A L

Thank you for purchasing the DLM3022, DLM3032, or DLM3052 digital oscilloscope or the DLM3024, DLM3034, or DLM3054 mixed signal oscilloscope. This User's Manual explains how to use the instrument. To ensure correct use, please read this manual thoroughly before operation. After reading this manual, keep it in a safe place. The manuals for this instrument are listed on the next page. Please read all manuals.

Contact information of Yokogawa offices worldwide is provided on the following sheet.

Document No.	Description
PIM 113-01Z2	List of worldwide contacts

Notes

- The contents of this manual are subject to change without prior notice as a result of continuing improvements to the instrument's performance and functionality. Refer to our website to view our latest manuals.
- The figures given in this manual may differ from those that actually appear on your screen.
- Every effort has been made in the preparation of this manual to ensure the accuracy of its contents. However, should you have any questions or find any errors, please contact your nearest YOKOGAWA dealer.
- Copying or reproducing all or any part of the contents of this manual without the permission of YOKOGAWA is strictly prohibited.
- The TCP/IP software of this product and the documents concerning it have been developed/created by YOKOGAWA based on the BSD Networking Software, Release 1 that has been licensed from the Regents of the University of California.

Trademarks

- Microsoft, Windows, Windows 10, and Windows 11 are registered trademarks or trademarks of Microsoft Corporation in the United States and/or other countries.
- Adobe and Acrobat are either registered trademarks or trademarks of Adobe Systems Incorporated.
- DLM is a registered trademark of Yokogawa Electric Corporation.
- In this manual, the TM and ® symbols do not accompany their respective registered trademark or trademark names.
- Other company and product names are trademarks or registered trademarks of their respective holders.

Revisions

- 1st Edition: November 2018
- 2nd Edition: June 2019
- 3rd Edition: July 2021
- 4th Edition: April 2022
- 5th Edition: June 2024

Manuals

The following manuals, including this one, are provided as manuals for this instrument. Please read all manuals.

Manuals Included with the Product

Manual Title	Manual No.	Description
DLM3022, DLM3032, DLM3052 Digital Oscilloscope DLM3024, DLM3034, DLM3054 Mixed Signal Oscilloscope Getting Started Guide	IM DLM3054-03EN	This guide explains the handling precautions, common operations, troubleshooting measures, and specifications of this instrument.
DLM3022, DLM3032, DLM3052 Digital Oscilloscope DLM3024, DLM3034, DLM3054 Mixed Signal Oscilloscope Operation Guide	IM DLM3054-04EN	Explains the basic operations of this instrument. Operations are described in steps from "Preparation" to "Displaying Waveforms," "Measuring Waveforms," and "Saving Screen Captures."
DLM3022, DLM3032, DLM3052 Digital Oscilloscope DLM3024, DLM3034, DLM3054 Mixed Signal Oscilloscope Request to Download Manuals	IM DLM3054-73Z2	Describes the manuals provided on the website.
DLM3022, DLM3032, DLM3052 Digital Oscilloscope DLM3024, DLM3034, DLM3054 Mixed Signal Oscilloscope	IM DLM3054-92Z1	Document for China
Safety Instruction Manual	IM 00C01C01-01Z1	Safety manual (European languages)

Manuals Provided on the Website

Download the following manuals from the YOKOGAWA website.

Manual Title	Manual No.	Description
DLM3022, DLM3032, DLM3052 Digital Oscilloscope DLM3024, DLM3034, DLM3054 Mixed Signal Oscilloscope Features Guide	IM DLM3054-01EN	This manual explains all the instrument's features other than the communication interface features.
DLM3022, DLM3032, DLM3052 Digital Oscilloscope DLM3024, DLM3034, DLM3054 Mixed Signal Oscilloscope User's Manual	IM DLM3054-02EN	This document. The manual explains how to operate this instrument.
DLM3022, DLM3032, DLM3052 Digital Oscilloscope DLM3024, DLM3034, DLM3054 Mixed Signal Oscilloscope Communication Interface User's Manual	IM DLM3054-17EN	The manual explains the functions of this instrument's communication interface, how to configure it, and the commands used to control this instrument from a PC through the interface.

For details on downloading manuals, see Request to Download Manuals (IM DLM3054-73Z2). To view the PDF data, you need Adobe Acrobat Reader or a software application that can open PDF data.

The "EN", "Z1", and "Z2" in the manual numbers are the language codes.

Online Help

The content similar to the *Features Guide*, IM DLM3054-01EN, is included in this instrument as a help file (some the content may be omitted). For instructions on how to use the help, see section 3.10 in the *Getting Started Guide*, IM DLM3054-03EN.

DLM Models and Conventions Used in This Manual

Models Explained

This manual explains the 4-channel model of this instrument. Channel settings vary depending on the model.

Notes

The notes and cautions in this manual are categorized using the following symbols.



Improper handling or use can lead to injury to the user or damage to the instrument. This symbol appears on the instrument to indicate that the user must refer to the user's manual for special instructions. The same symbol appears in the corresponding place in the user's manual to identify those instructions. In the manual, the symbol is used in conjunction with the word "WARNING" or "CAUTION."

WARNING

Calls attention to actions or conditions that could cause serious or fatal injury to the user, and precautions that can be taken to prevent such occurrences.

CAUTION

Calls attention to actions or conditions that could cause light injury to the user or damage to the instrument or user's data, and precautions that can be taken to prevent such occurrences.

French

AVERTISSEMENT

Attire l'attention sur des gestes ou des conditions susceptibles de provoquer des blessures graves (voire mortelles), et sur les précautions de sécurité pouvant prévenir de tels accidents.

ATTENTION

Attire l'attention sur des gestes ou des conditions susceptibles de provoquer des blessures légères ou d'endommager l'instrument ou les données de l'utilisateur, et sur les précautions de sécurité susceptibles de prévenir de tels accidents.

Note

Calls attention to information that is important for the proper operation of the instrument.

Prefixes k and K

Prefixes k and K used before units are distinguished as follows:

k	Denotes 1000. Example: 100 kS/s (sample rate)
K	Denotes 1024. Example: 720 KB (file size)

Contents

Manuals	ii
DLM Models and Conventions Used in This Manual	iii

Chapter 1 Vertical and Horizontal Control

⚠ 1.1	Setting the Vertical Axis (Analog Signal)	1-1
1.2	Setting the Vertical Axis (Logic Signal) (On models with the logic signal input port).....	1-7
1.3	Setting the Horizontal Scale (Time Scale).....	1-14

Chapter 2 Trigger

2.1	Setting the Trigger Mode and Trigger Hold-off Time.....	2-1
2.2	Setting the Trigger Position and Trigger Delay	2-2

Edge Trigger

2.3	Triggering on an Edge Trigger.....	2-4
-----	------------------------------------	-----

Enhanced Trigger

2.4	Triggering on the OR of Multiple Edge Triggers	2-6
2.5	Triggering on Multiple Input Patterns.....	2-7
2.6	Triggering on Pulse Width	2-11
2.7	Triggering on Rise and Fall Times.....	2-13
2.8	Triggering on Runt Signals	2-15
2.9	Triggering on Timeout Period	2-17
2.10	Triggering on a Window Trigger	2-18
2.11	Triggering on the OR of Multiple Window Triggers.....	2-20
2.12	Triggering on Edge Intervals	2-21
2.13	Triggering on FlexRay Bus Signals (Option)	2-23
2.14	Triggering on CAN Bus Signals (Option).....	2-26
2.15	Triggering on CAN FD Bus Signals (Option).....	2-31
2.16	Triggering on LIN Bus Signals (Option).....	2-37
2.17	Triggering on CXPI Bus Signals (Option).....	2-41
2.18	Triggering on SENT Signals (Option)	2-46
2.19	Triggering on PS15 Airbag Signals (Option).....	2-53
2.20	Triggering on UART Signals (Option).....	2-57
2.21	Triggering on I ² C Bus Signals (Option)	2-61
2.22	Triggering on SPI Bus Signals (Option).....	2-66
2.23	Triggering On User-Defined Serial Bus Signals	2-70
2.24	Triggering on a TV Trigger.....	2-73

B Trigger

2.25	Triggering on Combination Triggers (B TRIG).....	2-75
------	--	------

Forced Trigger

2.26	Forcing the Instrument to Trigger (FORCE TRIG).....	2-77
------	---	------

Action, GO/NO-GO

2.27	Setting the Action-On-Trigger Function	2-78
2.28	Performing GO/NO-GO Determination.....	2-79

Chapter 3	Waveform Acquisition	
3.1	Setting Conditions for Waveform Acquisition.....	3-1
3.2	Acquiring Waveforms	3-3
Chapter 4	Screen Display	
4.1	Setting Display Conditions	4-1
4.2	Using the Accumulate Feature	4-3
4.3	Using the Snapshot and Clear Trace Features	4-4
4.4	Adjusting the Backlight.....	4-5
Chapter 5	XY Display	
5.1	Displaying XY Waveforms	5-1
5.2	Performing Cursor Measurements and Area Calculations	5-2
Chapter 6	Computed and Reference Waveforms	
6.1	Setting the Computation Mode.....	6-1
6.2	Performing Addition, Subtraction, and Multiplication	6-2
6.3	Performing Filter Functions	6-3
6.4	Performing Integration.....	6-5
6.5	Performing Count Computations.....	6-6
6.6	Setting Labels, Units, and Scaling.....	6-9
6.7	Loading Reference Waveforms	6-10
6.8	Performing User-Defined Computations (Optional).....	6-12
Chapter 7	FFT	
7.1	Displaying FFT Waveforms	7-1
7.2	Measuring FFT Waveforms	7-3
Chapter 8	Cursor measurement	
8.1	Measuring with ΔT Cursors	8-1
8.2	Measuring with ΔV cursors.....	8-2
8.3	Measuring with ΔT and ΔV Cursors.....	8-3
8.4	Measuring with Marker Cursors (Marker).....	8-4
8.5	Measuring with Angle Cursors (Degree)	8-5
Chapter 9	Automated Measurement of Waveform Parameters	
9.1	Automatically Measuring Waveform Parameters	9-1
9.2	Processing Statistics on Automatically Measured Values	9-5
9.3	Measuring Enhanced Parameters.....	9-10
Chapter 10	Zooming in or out of Waveforms	
10.1	Zooming in or out of waveforms	10-1
10.2	Zooming in or out of Waveforms in the Vertical Direction.....	10-3
Chapter 11	Searching Waveforms	
11.1	Searching for Edges	11-1
11.2	Searching with Multiple Input Patterns	11-4
11.3	Searching for Pulse Width.....	11-8
11.4	Searching for Timeout Periods	11-11

Chapter 12 Analyzing and Searching Serial Bus Signals

12.1 Analyzing and Searching FlexRay Bus Signals (Option) 12-1
12.2 Analyzing and Searching CAN Bus Signals (Option) 12-5
12.3 Analyzing and Searching CAN FD Bus Signals (Option) 12-10
12.4 Analyzing and Searching LIN Bus Signals (Option) 12-15
12.5 Analyzing and Searching CXPI Bus Signals (Option) 12-20
12.6 Analyzing and Searching SENT Signals (Option) 12-25
12.7 Analyzing and Searching PS15 Airbag Signals (Option)..... 12-32
12.8 Analyzing and Searching UART Signals (Option) 12-39
12.9 Analyzing and Searching I²C Bus Signals (Option)..... 12-46
12.10 Analyzing and Searching SPI Bus Signals (Option)..... 12-52
12.11 Analyzing and Searching User-Defined Serial Bus Signals 12-60
12.12 Displaying Multiple Lists 12-65

Chapter 13 Waveform Histogram Display

13.1 Displaying Waveform Histograms 13-1
13.2 Measuring Histogram Parameters..... 13-2

Chapter 14 Power Supply Analysis (Power Analysis and Power Measurement, Option)

14.1 Power supply analysis type 14-1
14.2 Analyzing Switching Loss 14-2
14.3 Performing Safe Operating Area Analysis 14-5
14.4 Performing Harmonic Analysis 14-6
14.5 Measuring the Joule Integral 14-9
14.6 Measuring Power 14-10

Chapter 15 Displaying and Searching History Waveforms

15.1 Displaying History Waveforms..... 15-1
15.2 Searching History Waveforms 15-4

Chapter 16 Printing and Saving Screen Captures

⚠ 16.1 Loading Roll Paper Into the Built-In Printer (Option) 16-1
16.2 Printing on the Built-in Printer (Option)..... 16-3
16.3 Printing on a USB Printer 16-4
16.4 Printing on a Network Printer 16-5
16.5 Saving Screen Captures to Files 16-6
16.6 Printing and Saving Screen Capture Data to Multiple Output Destinations at the Same Time..... 16-9

Chapter 17 Saving and Loading Data

17.1 Connecting USB Storage Device to the USB Ports 17-1
17.2 Saving Waveform Data..... 17-2
17.3 Saving Setup Data 17-6
17.4 Saving Other Types of Data 17-7
17.5 Loading Waveform Data..... 17-10
17.6 Loading Setup Data..... 17-12
17.7 Loading Other Types of Data..... 17-13
17.8 Performing File Operations 17-15

Chapter 18 Ethernet Communication

18.1	Connecting the Instrument to a Network	18-1
18.2	Configuring TCP/IP Settings.....	18-3
18.3	Accessing the instrument from a PC (FTP Server)	18-4
18.4	Configuring Mail Transmission (SMTP Client Function).....	18-5
18.5	Connecting to a Network Drive.....	18-6
18.6	Configuring a Network Printer	18-7
18.7	Using SNTP to Set the Date and Time.....	18-8

Chapter 19 Other Operations

19.1	Changing the Menu, Message , and USB Keyboard Languages.....	19-1
19.2	Setting the Click Sound, Measured Value Font Size, and Number of Rows for Displaying Measurement Values.....	19-2
19.3	Viewing Setup Information (Overview)	19-3
19.4	Using the Instrument as a USB Storage Device	19-4

Index

1.1 Setting the Vertical Axis (Analog Signal)

This section explains the following settings for the vertical axis for analog signals:

CH menu

- Turning waveform display on or off
- Input coupling
- Probe
- Turning inverted waveform display on and off
- linear scaling
- Label display
- Bandwidth limit
- Offset

UTILITY menu

- Turning offset cancel on or off

SCALE knob

- Vertical scale

◆ POSITION knob

- Waveform vertical position

► “Vertical Axis (Analog Signal)” in the Features Guide

CH Menu

1. Press a key from **CH1** to **CH4**. The channel key illuminates brightly, and the following menu appears.

You can also tap **MENU** (ⓘ) in the upper left of the screen and select the CH menu from VERTICAL on the top menu that is displayed.

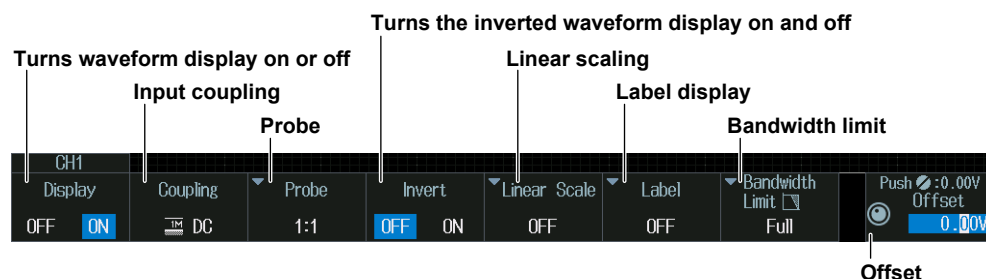

2. If you press a channel key different from step 1, that channel becomes configurable. The channel key being configured illuminates brightly, and the channel key selected in Step 1 is dark.

Note

- When waveform display is on, channel keys (CH1 to CH4) whose illuminate. You can press channel keys that are not illuminated to turn their waveform displays on. You can press channel keys that are illuminated to turn their waveform displays off.
- When the record length (Record Length) of the ACQUIRE menu is set to the maximum record length, the CH2 and CH4 waveforms cannot be used. For details on the ACQUIRE menu, see section 3.1.

1.1 Setting the Vertical Axis (Analog Signal)

Input Coupling (Coupling)

- AC: Displays the waveform produced from only the AC component of the input signal through 1 M Ω .
- DC: Displays the waveform produced from both the DC and AC components of the input signal through 1 M Ω .
- DC50: Displays the waveform produced from both the DC and AC components of the input signal through 50 Ω .

Input Coupling Settings and Frequency Response

The frequency responses when the input coupling is set to AC, DC, and DC50 are shown below. Note that if the input coupling is set to AC, the instrument does not acquire low-frequency signals or signal components as indicated in the figure below.

If AC is selected

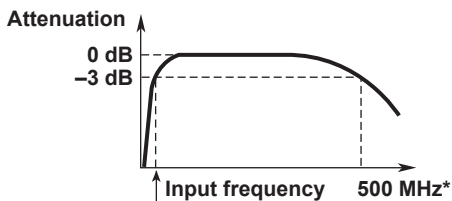

About 1 Hz when 1:1 probe is used
1 Hz or lower when 10:1 probe is used

If DC or DC50 is selected

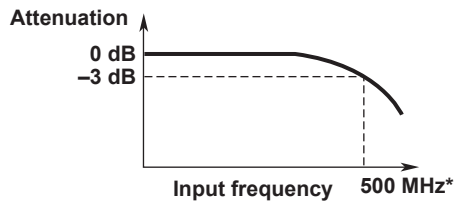

* The high-frequency -3 dB point differs according to the model and the voltage scale settings.



WARNING

- If over-range is indicated, the instrument may be receiving a voltage higher than the observed waveform or measured waveform values. To prevent electric shock, change the vertical scale with the SCALE knob so that the entire amplitude of the waveform is displayed within the waveform display area, and check the input voltage level.



← Over-range indication

- If the input coupling is AC, in accordance with the frequency response, the input signal is attenuated more in lower frequencies. As such, even when a high voltage signal is received, the over-range indicator may not be displayed on the instrument's screen. As necessary, switch the input coupling to DC to check the input signal voltage.



CAUTION

- The maximum input voltage in the case of 1 M Ω input is 300 Vrms or 400 Vpeak when the frequency is 100 kHz or less. Applying a voltage greater than either of these limits may damage the input section. For frequencies above 100 kHz, damage may occur even if the voltage is below this value.
- The maximum input voltage for 50 Ω input is 5 Vrms or 10 Vpeak. Applying a voltage greater than either of these limits may damage the input section.
- If you change the input coupling setting while waveform acquisition is stopped, the input coupling on the instrument is actually changed when waveform acquisition is executed the next time. Be careful of the maximum input voltage.

French

**AVERTISSEMENT**

- En cas de dépassement de plage, l'instrument risque de recevoir une tension supérieure à la forme d'onde observée ou aux valeurs de forme d'onde mesurées. Pour éviter tout risque de choc électrique, modifier l'échelle de gain vertical à l'aide du bouton SCALE, de sorte que l'amplitude entière de la forme d'onde s'affiche sur l'afficheur, et vérifier le niveau de tension d'entrée.



← Dépassement de plage

- Si le courant du couplage d'entrée est alternatif (CA), conforme à la réponse en fréquence, le signal d'entrée est plus atténué aux fréquences plus basses. Ainsi, même si un signal haute tension est reçu, le voyant de dépassement de plage risque de ne pas s'afficher à l'écran de l'instrument. Le cas échéant, basculez le couplage d'entrée sur CC (courant continu) afin de vérifier la tension du signal d'entrée.

**ATTENTION**

- La tension d'entrée maximum pour une entrée de 1 M Ω est de 300 Vrms ou 400 V crête lorsque la fréquence est inférieure ou égale à 100 kHz. Le fait d'appliquer une tension dépassant l'une de ces limites risque d'endommager la section d'entrée. Si la fréquence est supérieure à 100 kHz, des dommages risquent de survenir même lorsque la tension est inférieure à cette valeur.
- La tension d'entrée maximale pour une entrée de 50 Ω est de 5 Vrms ou 10 Vcrête. L'application d'une tension supérieure à l'une de ces limites pourrait endommager la section d'entrée.
- Si vous modifiez le paramètre de couplage d'entrée alors que l'acquisition de forme d'onde est arrêtée, le couplage d'entrée sur l'instrument est en réalité modifié lorsque la prochaine acquisition de forme d'onde est exécutée. Faites attention à la tension d'entrée maximale.

1.1 Setting the Vertical Axis (Analog Signal)

Probe (Probe)

Press the **Probe** soft key. The following menu items appear.

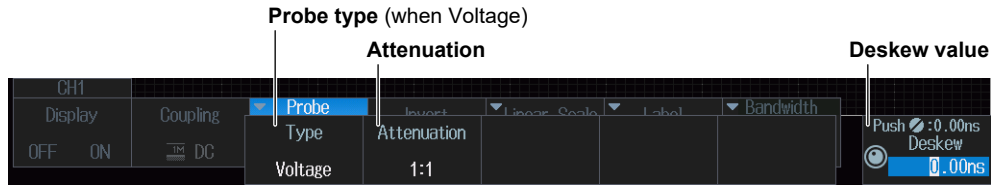

When the probe type is Current

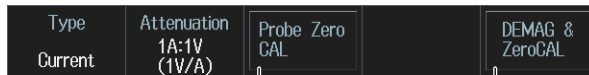

Execute the demagnetization and automatic zero adjustment of current probes.
(Execution is only possible when a YOKOGAWA PBC100 or PBC050 is connected.)

Execute automatic zero adjustment of current probes
(can only be executed when current probes are connected)

Note

When a current probe with a YOKOGAWA probe interface (such as a the PBC100 or PBC050 probe) is connected to the instrument, you can execute demagnetization and automatic zero adjustment from the instrument.

When you demagnetize and perform automatic zero adjustment on a current probe, do not clamp the conductor. If you demagnetize a current probe while the conductor is clamped, the current that flows through the conductor as a result of demagnetization may damage components of the DUT circuitry.

Linear Scaling (Linear Scale)

Press the **Linear Scale** soft key. The following menu items appear.

Turn linear scaling on or off.

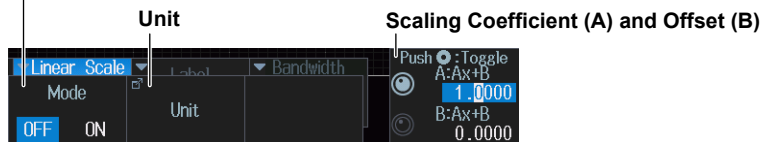

Label Display (Label)

Press the **Label** soft key. The following menu items appear.

Turns label display on or off



Bandwidth Limit (Bandwidth Limit)

Press the **Bandwidth Limit** soft key. The jog shuttle controls Bandwidth Limit.

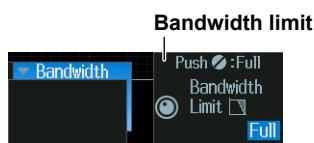

UTILITY System Configuration Menu

Press **UTIL** and then the **System Configuration** soft key. The following menu items appear.

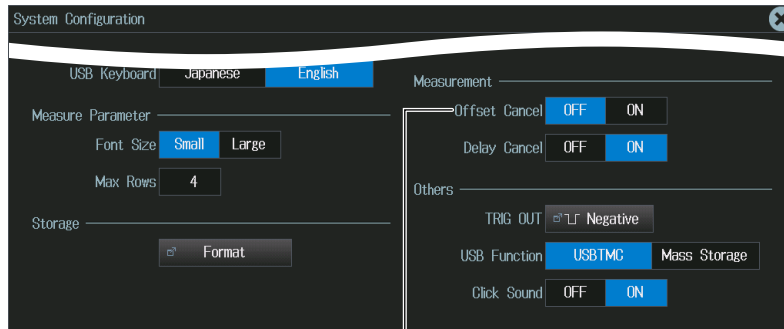

Turns offset canceling on or off

Turning Offset Cancel On or Off (Offset Cancel)

ON: The offset is subtracted from the input signal when cursor measurements, computations, and other operations are performed.

OFF: The offset is not subtracted from the input signal when cursor measurements, computations, and other operations are performed.

Vertical Scale (SCALE knob)

- Press a key from **CH1** to **CH4** to select the channel that you want to set the vertical scale for.
 - The CH key that you press illuminates brightly.
 - The LED between the **SCALE** and **POSITION** knobs illuminates in the color assigned to the selected channel (the color around the CH key).
- Turn the **SCALE** knob to set the vertical scale.

If you push the **SCALE** knob, the **FINE** indicator illuminates, allowing you to set the vertical scale with higher resolution.

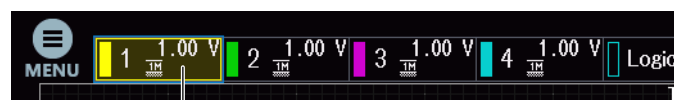
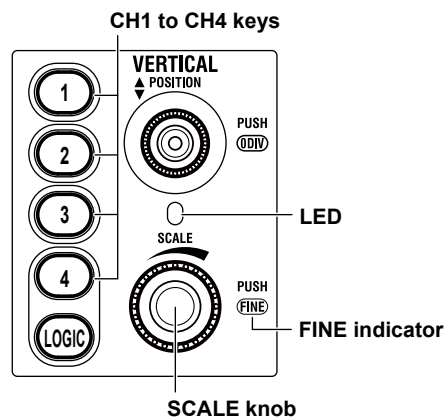

Displays the vertical scale and input coupling for each channel

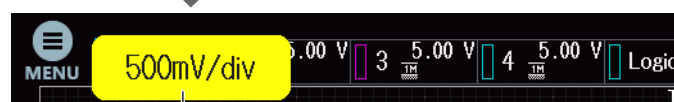

While you control the knob, the vertical scale value is displayed in the corresponding channel information display area. The display disappears after a few seconds when you stop controlling the knob.

1.1 Setting the Vertical Axis (Analog Signal)

Waveform Vertical Position (◀ POSITION knob)

1. Press a key from **CH1 to CH4** to select the channel that you want to set the vertical position for.
 - The CH key that you press illuminates brightly.
 - The LED between the SCALE and ▶ POSITION knobs illuminates in the color assigned to the selected channel (the color around the CH key).
2. Turn the ▶ **POSITION** knob to set the vertical position.
You can set the vertical position to 0 V by pressing the POSITION knob.

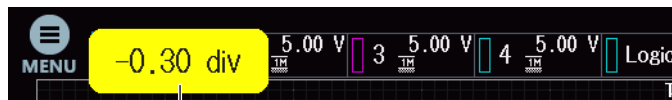
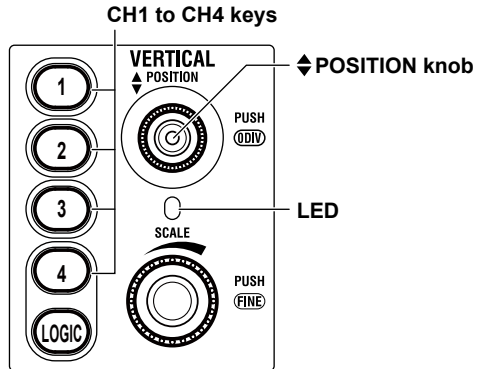

While you control the knob, the vertical position value is displayed in the corresponding channel information display area. The display disappears after a few seconds when you stop controlling the knob.

Note

Preview

- If you change the vertical scale when waveform acquisition is stopped, the waveform is displayed expanded or reduced vertically.
- If you change the vertical position when waveform acquisition is stopped, the waveform display position changes.

1.2 Setting the Vertical Axis (Logic Signal) (On models with the logic signal input port)

This section explains the following settings for the vertical axis for logic signals:

LOGIC Menu

- Turning waveform display on or off
- Set bits.
 - Turning bit display on and off, label name, threshold level, and noise rejection
- Bus display
 - Turning the bus display on or off, bus bit assignment, labels, and format
- State display
 - Turning state display on or off, clock source, clock source polarity, detection level, hysteresis, and state assignment
- Bit and bus display order
- Deskewing

SCALE knob

- Display size

◆ POSITION knob

- Vertical position

► [“Vertical Axis \(Logic Signal\)” in the Features Guide](#)

LOGIC Menu

Press **LOGIC**. The following menu items appear.

You can also tap **MENU** (ⓘ) in the upper left of the screen and select the LOGIC menu from VERTICAL on the top menu that is displayed.

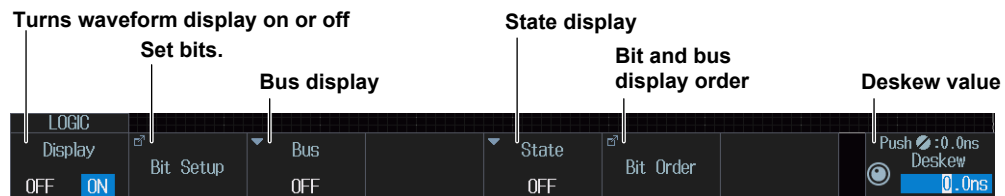

Note

- If you press the L key when it is not illuminated, the key illuminates, and the LOGIC waveform display turns on. Logic signal waveforms are displayed in the CH4 waveform display area.
- If you press the LOGIC key when it is illuminated, the key turns off, and the LOGIC waveform display turns off.
- When the record length (Record Length) of the ACQUIRE menu is set to the maximum record length, LOGIC waveforms cannot be used. For details on the ACQUIRE menu, see section 3.1.

1.2 Setting the Vertical Axis (Logic Signal) (On models with the logic signal input port)

Bit Settings (Bit Setup)

Press the **Bit Setup** soft key. The following screen appears.

For Logic Probes Other Than the 701989

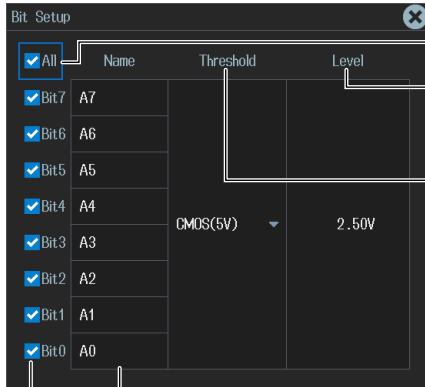

Turns the display on or off for all bits

Threshold level

If you change the automatically specified value, the preset setting changes to "Userdef."

Preset threshold levels

Selecting a preset automatically sets the threshold level.

Display on/off state and label of each bit

For the 701989 Logic Probe

- When the Threshold Type is All

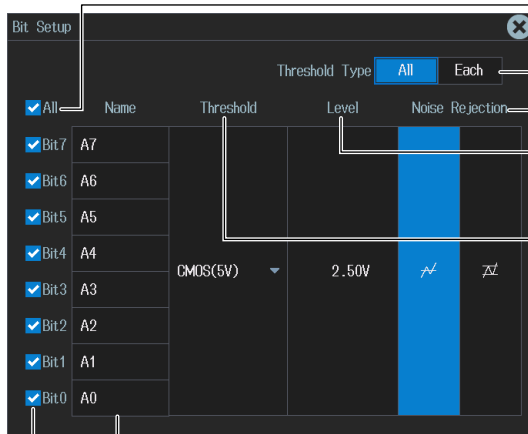

Turns the display on or off for all bits

The threshold type is set to All.

Noise rejection

Threshold level

If you change the automatically specified value, the preset setting changes to "Userdef."

Preset threshold levels

Selecting a preset automatically sets the threshold level.

Display on/off state and label of each bit

1.2 Setting the Vertical Axis (Logic Signal) (On models with the logic signal input port)

- When the Threshold Type is Each

Turns the display on or off for all bits

Preset threshold levels

- Selecting a preset automatically sets the threshold level.
- When the threshold type is Each, set the threshold level for each bit.

The threshold type is set to Each.

Threshold level

- If you change the automatically specified value, the preset setting changes to "Userdef."
- When the threshold type is Each, set the threshold level for each bit.

Noise rejection

Display on/off state and label of each bit

	Name	Threshold	Level	Noise Rejection
<input checked="" type="checkbox"/> All				
<input checked="" type="checkbox"/> Bit7	A7	CMOS(5V)	2.50V	
<input checked="" type="checkbox"/> Bit6	A6	CMOS(5V)	2.50V	
<input checked="" type="checkbox"/> Bit5	A5	CMOS(5V)	2.50V	
<input checked="" type="checkbox"/> Bit4	A4	CMOS(5V)	2.50V	
<input checked="" type="checkbox"/> Bit3	A3	CMOS(5V)	2.50V	
<input checked="" type="checkbox"/> Bit2	A2	CMOS(5V)	2.50V	
<input checked="" type="checkbox"/> Bit1	A1	CMOS(5V)	2.50V	
<input checked="" type="checkbox"/> Bit0	A0	CMOS(5V)	2.50V	

Note

- For logic probes other than the 701989, the threshold type is All. The setup menu does not appear.
 - The Level and Noise Rejection* of Bit Setup are linked with the Level and Noise Rejection* settings when LOGIC is set as the source in the trigger settings.
- * You can set this when the logic probe is 701989.

1.2 Setting the Vertical Axis (Logic Signal) (On models with the logic signal input port)

Bus Display (Bus)

Press the **Bus** soft key. The following menu items appear.

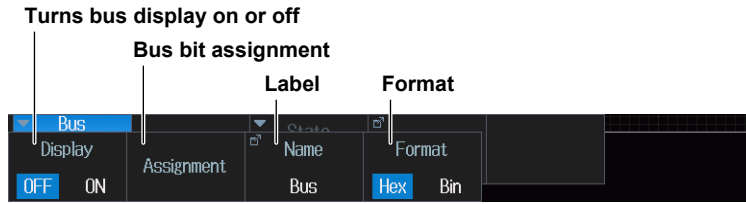

Bus bit assignment

1. Press the **Assignment** soft key. The assignment edit screen appears.
2. Press the cursor movement soft key on the Edit menu to move the cursor to the right of the position where the bit is to be placed.
3. Turn the jog shuttle, or move the **SET** key up, down, left, or right to select the bit to be placed from the group of bits.
4. Press **SET**.
The selected bit is placed to the left of the cursor position.
5. Press the **ENTER** soft key to confirm the setting.

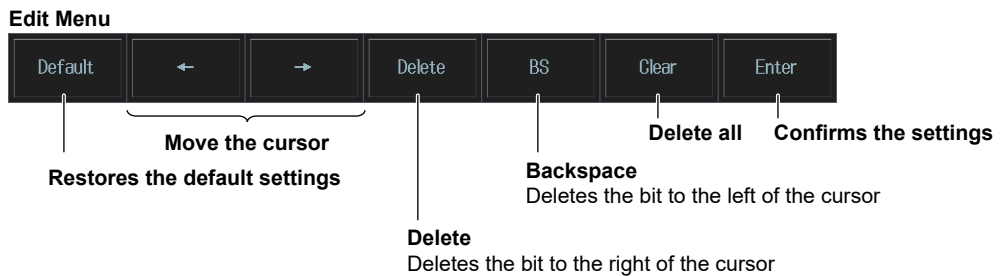
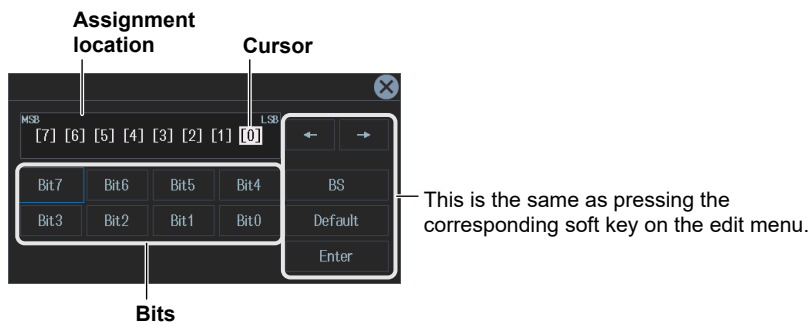

State Display (State)

Press the **State** soft key. The following menu items appear.

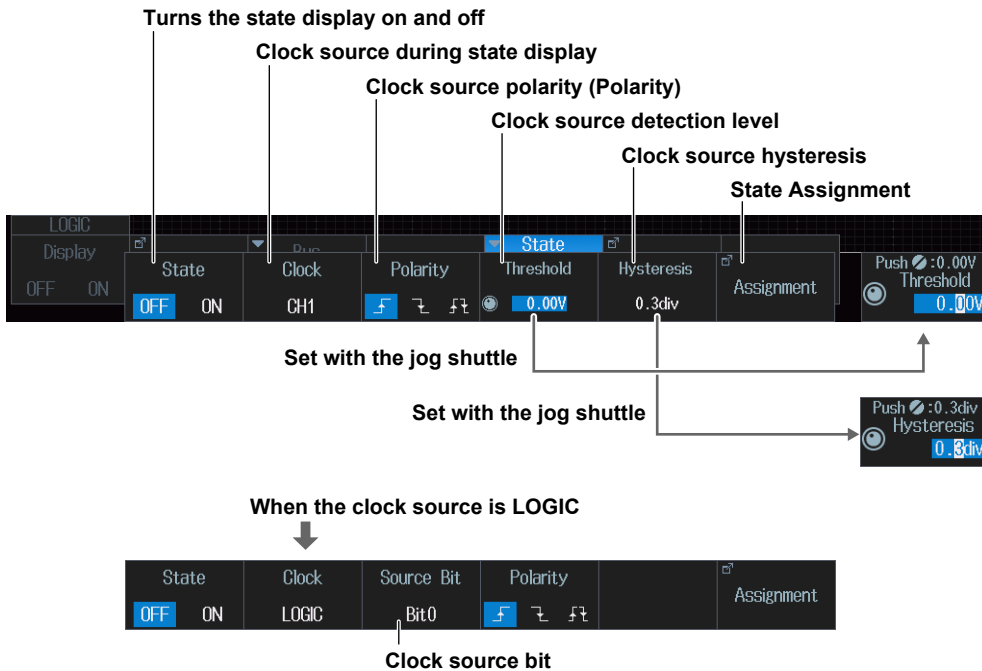

State Assignment

Press the **Assignment** soft key. The following screen appears.

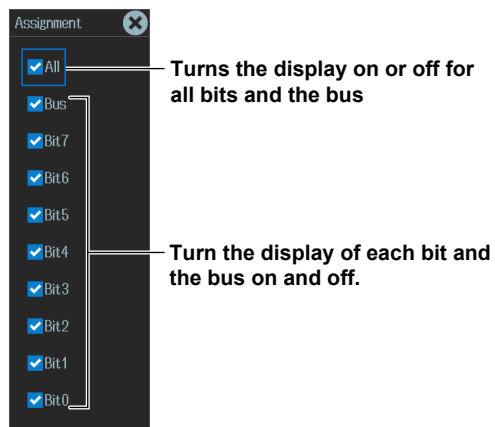

1.2 Setting the Vertical Axis (Logic Signal) (On models with the logic signal input port)

Bit and Bus Display Order (Bit Order)

Press the **Bit Order** soft key. The following screen appears.

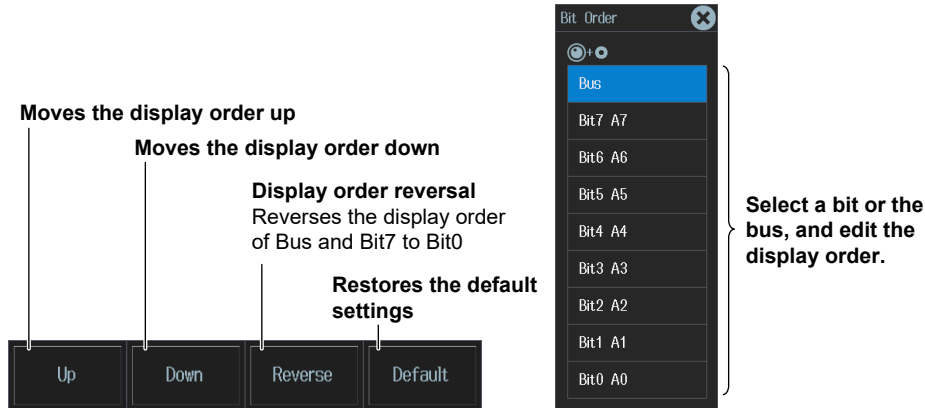

1. Turn the jog shuttle or move the **SET** key up and down to select the bit or bus to move. The selected bit or bus cell is highlighted.

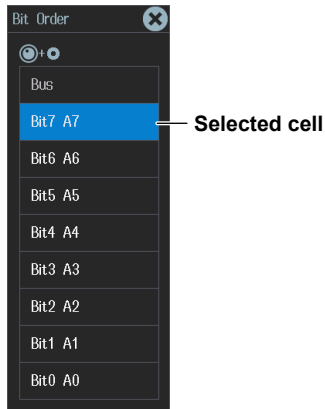

2. Press the **Up** or **Down** soft key to move the selected bit or bus up or down. Every time the selected bit or bus moves up or down, the order of the upper and lower bits or bus is switched.

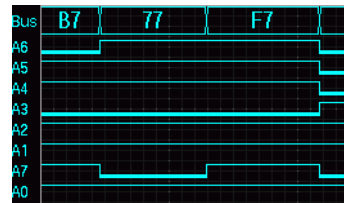
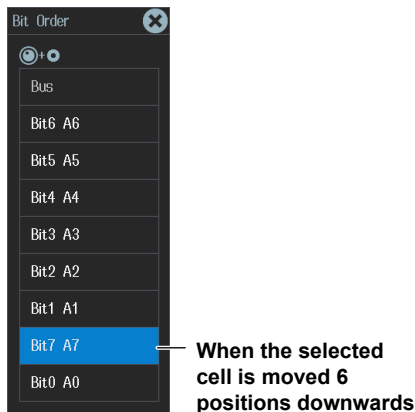

The change affects the bit and bus display order along the vertical axis of the screen.

Deskew (Deskew)

Set the adjustment values for the time offsets (skew) between the logic signal and other signals, which are caused by the use of different types of probes. Deskewing is performed on all eight bits collectively.

Display Size (SCALE Knob)

1. Press **LOGIC** to make the SCALE knob control the LOGIC setting.
 - The LOGIC key illuminates brightly.
 - The LED between the SCALE and **POSITION** knobs illuminates in the color assigned to the LOGIC channel (the color around the LOGIC key).
2. Turn the **SCALE** knob to set the display size.

Vertical Position (POSITION Knob)

1. Press **LOGIC** to make the **POSITION** knob control the LOGIC setting.
 - The LOGIC key illuminates brightly.
 - The LED between the SCALE and **POSITION** knobs illuminates in the color assigned to the LOGIC channel (the color around the LOGIC key).
2. Turn the **POSITION** knob to set the vertical position.

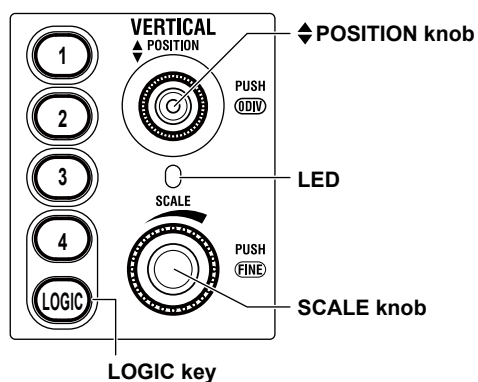

1.3 Setting the Horizontal Scale (Time Scale)

Set the time per grid (1 div) displayed on the screen.

Turn the **TIME/DIV** knob to set the value.

If you change the TIME/DIV setting while waveform acquisition is stopped, the waveform is displayed expanded or reduced horizontally.

► [“Horizontal Axis \(Time Axis\)” in the Features Guide](#)

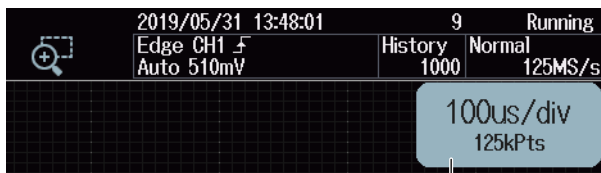
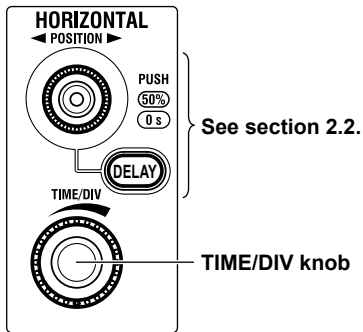

While you control the knob, the time scale value and display record length are displayed in the upper right of the screen. The display disappears after a few seconds when you stop controlling the knob.

2.1 Setting the Trigger Mode and Trigger Hold-off Time

This section explains the following settings for updating the displayed waveform:

- Trigger mode, acquisition length
- Hold-off time

► “Trigger mode (Trigger Mode)” and “Trigger Hold-off (Holdoff)” in the Features Guide

MODE menu

Press **MODE**. The following menu items appear.

You can also tap **MENU** (☰) in the upper left of the screen and select the MODE menu from TRIGGER on the top menu that is displayed.

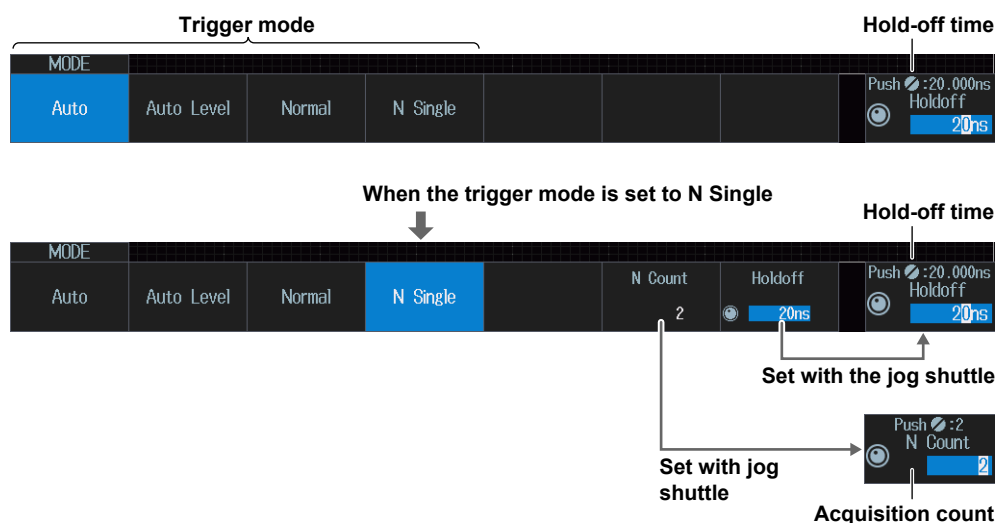

Trigger mode (Mode)

- Auto:** If the trigger conditions are met within a timeout period,* the instrument updates the displayed waveforms on each trigger occurrence. If not, this instrument automatically updates the displayed waveforms. If the time axis is set to a value that would cause the display to switch to roll mode, roll mode display will be enabled.
- Auto Level:** If a trigger occurs before a timeout,* the instrument updates the waveform in the same way that it does in Auto mode. If a trigger does not occur before a timeout, the instrument automatically changes the trigger level to the center value of the trigger source amplitude, triggers on that value, and updates the displayed waveform.
- Normal:** The instrument updates the waveform display only when the trigger conditions are met.
- N Single:** The instrument acquires signals each time the trigger conditions are met until a specified number of signals have been acquired, and then displays all of the acquired signals.
- * The timeout period is 100 ms or the time corresponding to 10 divisions on the time axis, whichever is larger.

Note

Press any of the trigger mode soft keys to execute waveform acquisition in the selected trigger mode.

Single mode

There is also a Single trigger mode in which the instrument updates the displayed waveform once and stops signal acquisition when the trigger conditions are met. Press SINGLE on the front panel to execute Single Mode waveform acquisition.

Hold-off time (Holdoff)

The trigger hold-off feature temporarily stops the detection of the next trigger once a trigger has occurred.

2.2 Setting the Trigger Position and Trigger Delay

This section explains the following settings for updating the displayed waveform:

- Trigger position
- Trigger delay
- Turning delay canceling on or off

► “Trigger Position (POSITION Knob),”
“Trigger Delay (DELAY),” and
“Delay Cancel (Delay Cancel),”
in the Features Guide

Trigger Position (◀ POSITION ▶ knob)

1. Turn the ◀ POSITION ▶ knob to set the trigger position.

The specified trigger position is displayed at the top of the screen while you control the knob. The display disappears after a few seconds when you stop controlling the knob.

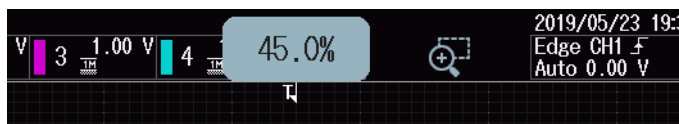

* You can set the trigger position even when waveforms are not being acquired.

Trigger Delay (DELAY)

1. Press DELAY.

The DELAY key illuminates.

2. Turn the ◀ POSITION ▶ knob to set the trigger delay.

The specified trigger delay is displayed at the top of the screen while you control the knob. The display disappears after a few seconds when you stop controlling the knob.



* You can set the trigger delay even when waveforms are not being acquired.

3. Press DELAY again.

The DELAY key turns off, and you can set the trigger position.

Turning Delay Cancel On or Off (Delay Cancel)

1. Press **UTIL**. The UTILITY menu appears.
You can also tap **MENU** (☰) in the upper left of the screen and select the UTILITY menu from UTILITY on the top menu that is displayed.
2. Press the **System Configuration** soft key. The following menu items appear.

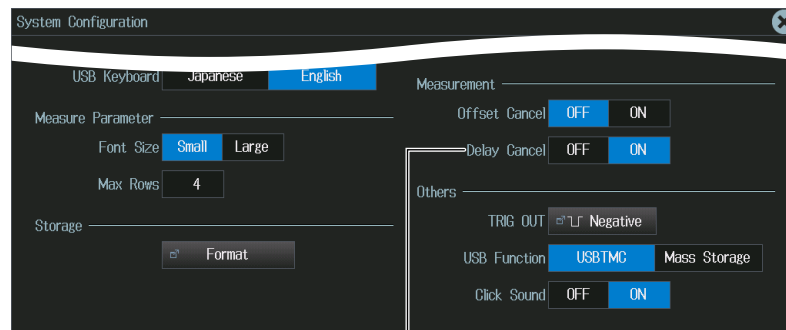

Turns delay canceling on or off

You can select whether or not to apply the specified trigger delay to the time measurement values.

ON: Measures time with the trigger position set to 0 s (does not apply the delay to time measurement)

OFF: Measures time with the trigger point set to 0 s (applies the delay to time measurement)

2.3 Triggering on an Edge Trigger

This section explains the following settings for triggering on trigger source edges:

- Trigger source
 - Trigger slope, HF rejection, noise rejection, level used to detect trigger source edges, source bit
- Probe attenuation
- Input range

► “Edge Trigger (EDGE),”
 “Trigger Source (Source),”
 “Trigger Slope (Slope/Polarity),”
 “HF Rejection (HF Rejection),”
 “Noise Rejection (Noise Rejection),” and
 “Trigger Level (Level)” in the Features Guide

EDGE menu

Press **EDGE**. The menu that appears varies depending on the specified trigger source.

You can also tap **MENU** (E) in the upper left of the screen and select the EDGE menu from TRIGGER on the top menu that is displayed.

When the Trigger Source Is from CH1 to CH4

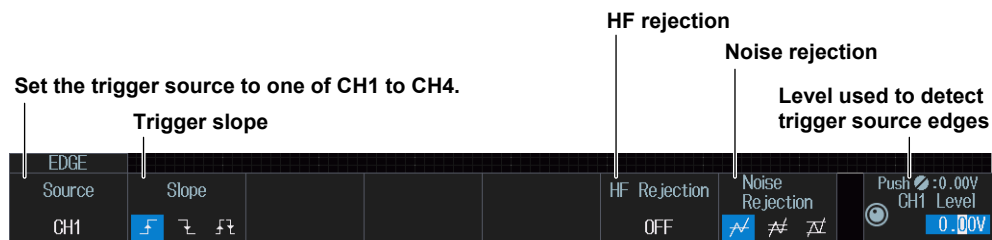

When the Trigger Source Is LOGIC (On models with the logic signal input port)

Set the trigger source to LOGIC.



For the 701989 Logic Probe



When the Trigger Source Is EXT (External trigger signal)

Set the trigger source to EXT.

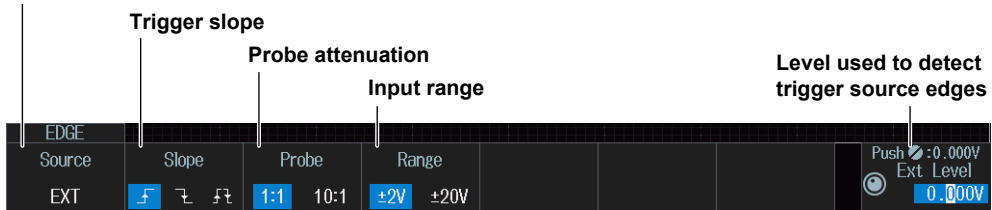

Input Range (Range)

When the trigger source is set to EXT, select the input range.

The selectable ranges vary depending on the probe attenuation setting.

1:1: ±2 V or ±20 V

10:1: ±20 V or ±200 V

When the Trigger Source Is LINE

Set the trigger source to LINE.



2.4 Triggering on the OR of Multiple Edge Triggers

This section explains the following settings for triggering on the logical OR of multiple edge triggers:

- Trigger source pattern
Trigger source, trigger slope
- Trigger level
Level used to detect trigger source edges, HF rejection, noise rejection

► [“Edge OR Trigger \[ENHANCED\]” in the Features Guide](#)

ENHANCED Edge OR menu

1. Press **ENHANCED**. The ENHANCED menu appears.
You can also tap **MENU** (MENU) in the upper left of the screen and select the ENHANCED menu from TRIGGER on the top menu that is displayed.
2. Press the **Type** soft key. Select **Edge OR** from the setup menu that is displayed. The following menu items appear.



Trigger Source Pattern (Pattern)

Press the **Pattern** soft key. The following menu items appear.

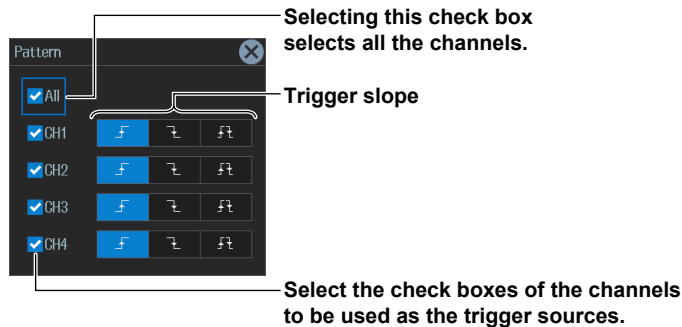

Trigger Levels (Levels)

Press the **Levels** soft key. The following menu items appear.

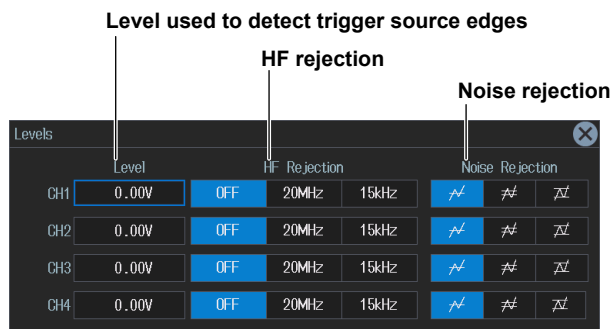

2.5 Triggering on Multiple Input Patterns

This section explains the following settings for triggering on multiple input patterns:

- Clock source
 - Source bit
- Comparison condition
 - Trigger source pattern, combination
- Trigger condition
 - Time condition, reference time
 - Trigger level
 - Level used to detect trigger source states, HF rejection, noise rejection
 - Level used to detect clock source edges

► [“Pattern Trigger \[ENHANCED\]” in the Features Guide](#)

ENHANCED Pattern Menu

1. Press **ENHANCED**. The ENHANCED menu appears.
You can also tap **MENU** (☰) in the upper left of the screen and select the ENHANCED menu from TRIGGER on the top menu that is displayed.
2. Press the **Type** soft key. Select **Pattern** from the setup menu that is displayed.

Clock Source (Clock)

3. Press the **Clock** soft key. Select the clock source from the setup menu that is displayed. The menu that appears varies depending on the specified clock source.

When the Clock Source Is from CH1 to CH4

Set the trigger type to Pattern.

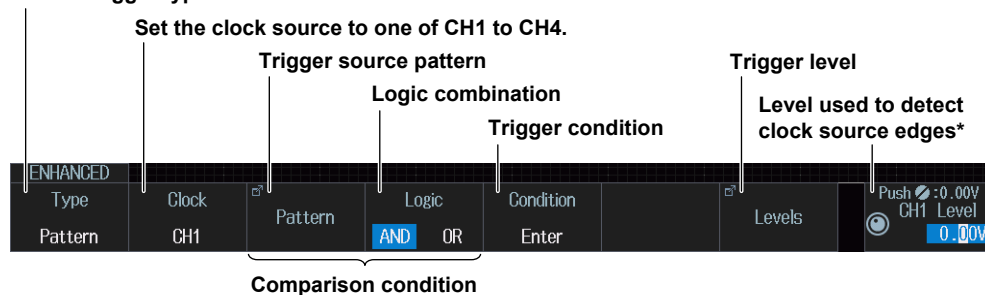

* You can also set the level for detecting clock source edges on the setup screen for trigger levels (Levels).

When the Clock Source Is LOGIC (On models with the logic signal input port)

Set the trigger type to Pattern.

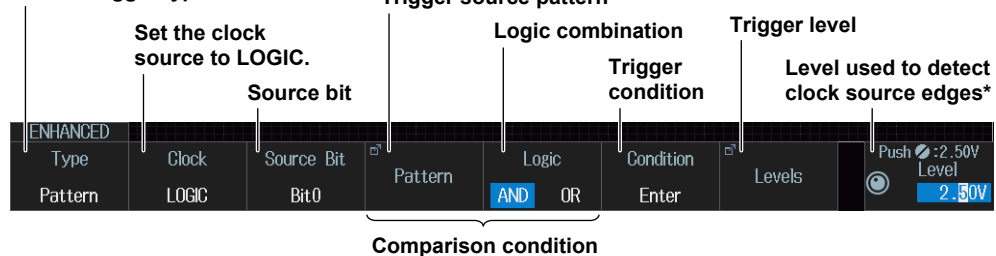

* You can also set the level for detecting clock source edges on the setup screen for trigger levels (Levels).

2.5 Triggering on Multiple Input Patterns

No Clock Source

Set the trigger type to Pattern.

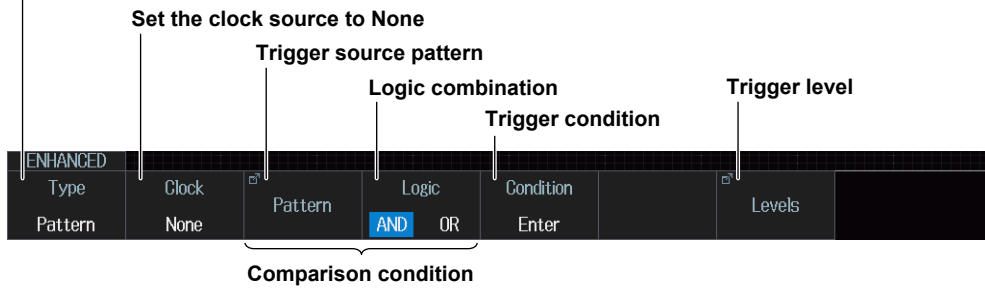

When the trigger condition is True or False

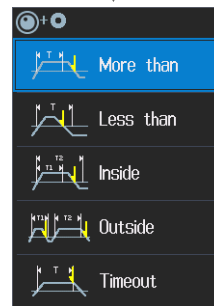
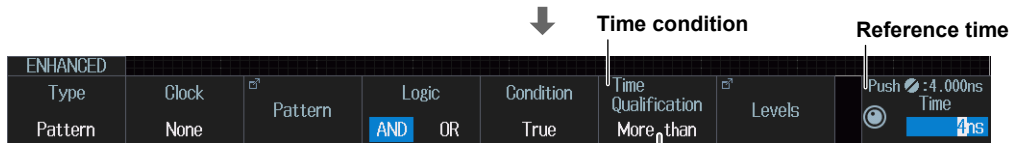

Trigger Source Pattern (Pattern)

Press the **Pattern** soft key. The following menu items appear.

When the Clock Source Is CH1 to CH4 or LOGIC (On models with the logic signal input port)

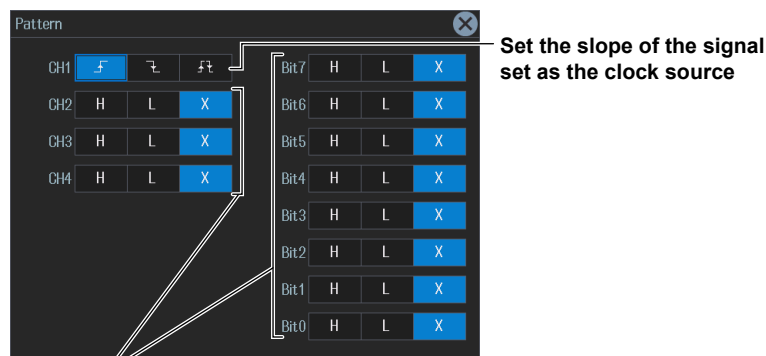

Set the pattern of the trigger source (signal other than the clock source).

No Clock Source

The same menu appears as that shown above for when the clock source is CH1 to CH4 or LOGIC (on models with the logic signal input port). Because there is no clock source, set the patterns of the trigger sources (all signals: CH1 to CH4, LOGIC).

Time Condition (Time Qualification)

If no clock source (None) is set, the time condition is set if the trigger condition is True or False.

Set what kind of relationship must be established between the comparison condition achievement time and the specified reference time (Time or Time1 and Time2).

For details on the trigger points when the time condition is met, see chapter 4, “Triggering” in the *Features Guide* (IM DLM3054-01EN). When Timeout is selected, the instrument triggers when a timeout occurs.

- More than : When the comparison condition achievement time is longer than the specified reference time (Time)
- Less than : When the comparison condition achievement time is shorter than the specified reference time (Time)
- Inside : When the comparison condition achievement time is longer than reference time Time1 and shorter than reference time Time2.
- Outside : When the comparison condition achievement time is shorter than reference time Time1 or longer than reference time Time2.
- Timeout : When the comparison condition achievement time is longer than the specified reference time (Time)

Reference time (Time or Time1 and Time2)

When the Time Condition is More than, Less than, or Timeout

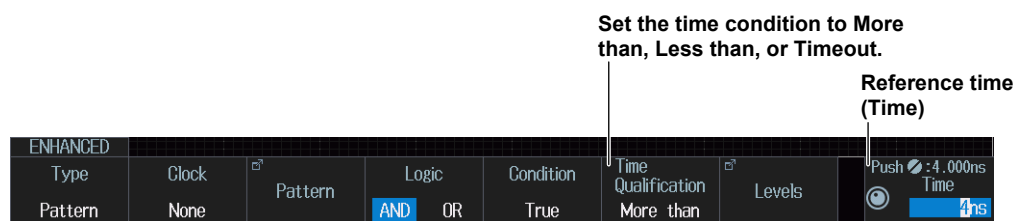

When the Time Condition is Inside or Outside

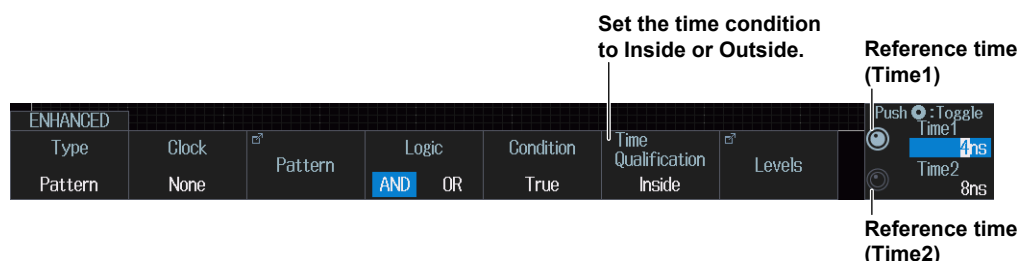

Trigger Levels (Levels)

Press the **Levels** soft key. The following menu items appear.

For Logic Probes Other Than the 701989

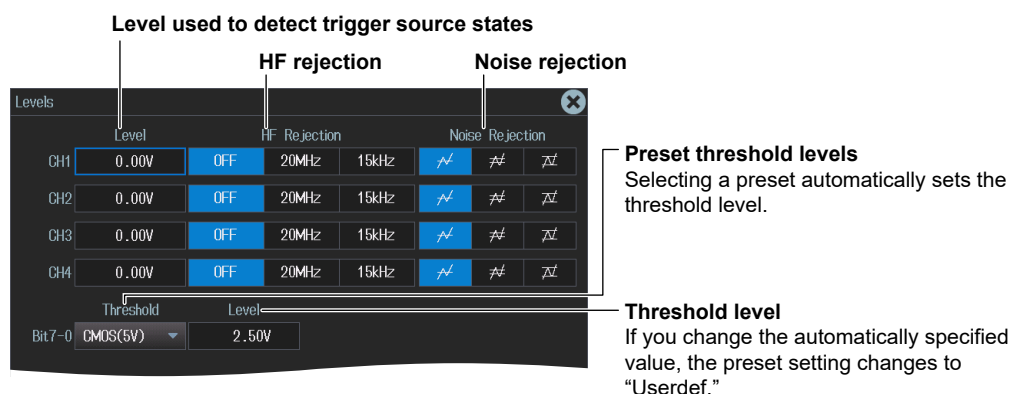

2.5 Triggering on Multiple Input Patterns

For the 701989 Logic Probe

- When the Threshold Type is All

Level used to detect trigger source states

HF rejection **Noise rejection**

Level	HF Rejection	HF Rejection	Noise Rejection	Noise Rejection	Noise Rejection		
CH1	0.00V	OFF	20MHz	15kHz	≠	≠	≠
CH2	0.00V	OFF	20MHz	15kHz	≠	≠	≠
CH3	0.00V	OFF	20MHz	15kHz	≠	≠	≠
CH4	0.00V	OFF	20MHz	15kHz	≠	≠	≠

Preset threshold levels
Selecting a preset automatically sets the threshold level.

Threshold level
If you change the automatically specified value, the preset setting changes to "Userdef."

Noise rejection **The threshold type is set to All.**

- When the Threshold Type is Each

Level used to detect trigger source states

HF rejection **Noise rejection**

Level	HF Rejection	HF Rejection	Noise Rejection	Noise Rejection	Noise Rejection		
CH1	0.00V	OFF	20MHz	15kHz	≠	≠	≠
CH2	0.00V	OFF	20MHz	15kHz	≠	≠	≠
CH3	0.00V	OFF	20MHz	15kHz	≠	≠	≠
CH4	0.00V	OFF	20MHz	15kHz	≠	≠	≠

Preset threshold levels

- Selecting a preset automatically sets the threshold level.
- When the threshold type is Each, set the threshold level for each bit.

Threshold level

- If you change the automatically specified value, the preset setting changes to "Userdef."
- When the threshold type is Each, set the threshold level for each bit.

The threshold type is set to Each.

Noise rejection

2.6 Triggering on Pulse Width

This section explains the following settings for triggering on pulse width:

- Trigger source
Polarity, HF rejection, noise rejection, source bit, level used to detect trigger source states
- Time condition, reference time

► [“Pulse Width Trigger \(ENHANCED\)” in the Features Guide](#)

ENHANCED Pulse Width menu

1. Press **ENHANCED**. The ENHANCED menu appears.
You can also tap **MENU** (☰) in the upper left of the screen and select the ENHANCED menu from TRIGGER on the top menu that is displayed.
2. Press the **Type** soft key. Select **Pulse Width** from the setup menu that is displayed. The following menu items appear.

Set the trigger type to Pulse Width.

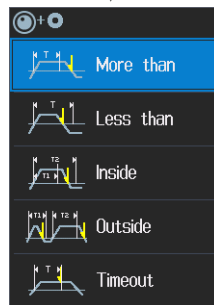

Trigger Source (Source)

Press the **Source** soft key. The menu that appears varies depending on the specified trigger source.

When the Trigger Source Is from CH1 to CH4

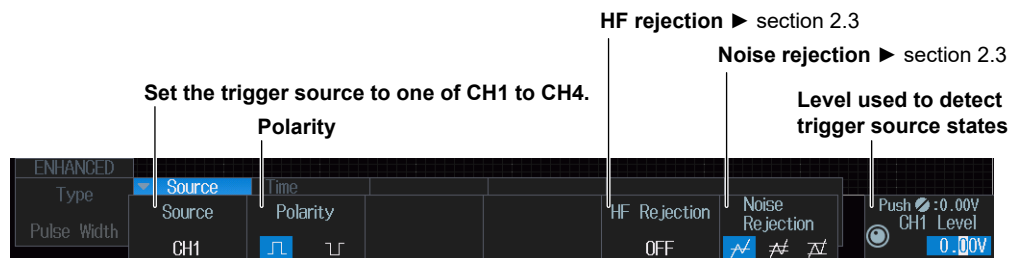

2.6 Triggering on Pulse Width

When the Trigger Source Is LOGIC (On models with the logic signal input port)

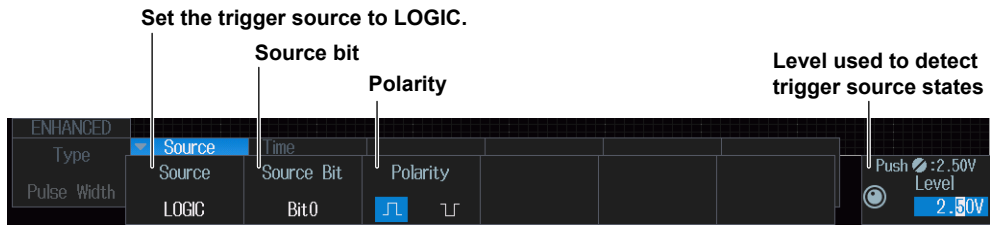

Time Condition (Time Qualification)

Set what kind of relationship must be established between the trigger source’s pulse width and the specified reference times (Time, Time1, and Time2) for the instrument to trigger. For details on the trigger points when the time condition is met, see chapter 4, “Triggering” in the *Features Guide* (IM DLM3054-01EN). When Timeout is selected, the instrument triggers when a timeout occurs.

- More than : When the pulse width is longer than the specified reference time (Time)
- Less than : When the pulse width is shorter than the specified reference time (Time)
- Inside : When the pulse width is longer than Time1 but shorter than Time2
- Outside : When the pulse width is shorter than Time1 or longer than Time2
- Timeout : When the pulse width is longer than the specified reference time (Time)

Reference time (Time or Time1 and Time2)

When the Time Condition is More than, Less than, or Timeout

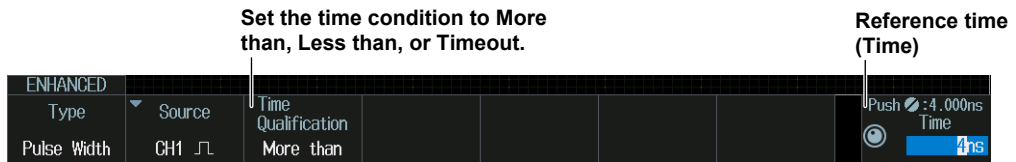

When the Time Condition is Inside or Outside

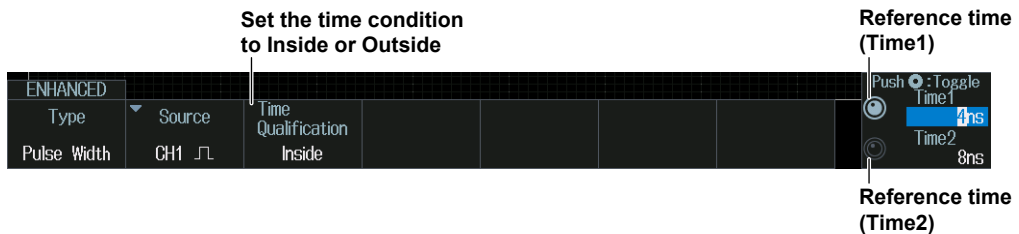

2.7 Triggering on Rise and Fall Times

This section explains the following settings for triggering on rise and fall times:

- Trigger source
Trigger slope, HF rejection, level used to detect trigger source edges
- Time condition, reference time

► [“Rise/Fall Time Trigger \(ENHANCED\)” in the Features Guide](#)

ENHANCED Rise/Fall Time Menu

1. Press **ENHANCED**. The ENHANCED menu appears.
You can also tap **MENU** (☰) in the upper left of the screen and select the ENHANCED menu from TRIGGER on the top menu that is displayed.
2. Press the **Type** soft key. Select **Rise/Fall Time** from the setup menu that is displayed. The following menu items appear.

Set the trigger type to Rise/Fall Time.

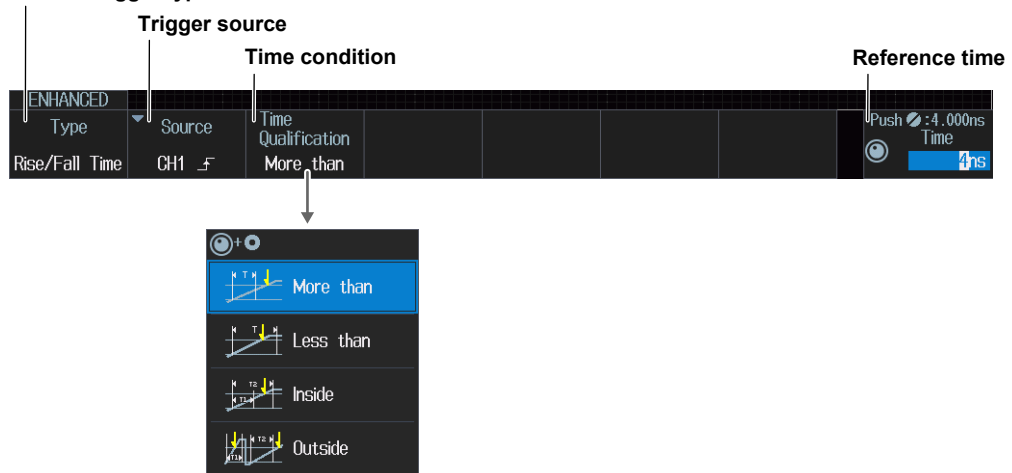

Trigger Source (Source)

Press the **Source** soft key. The following menu items appear.

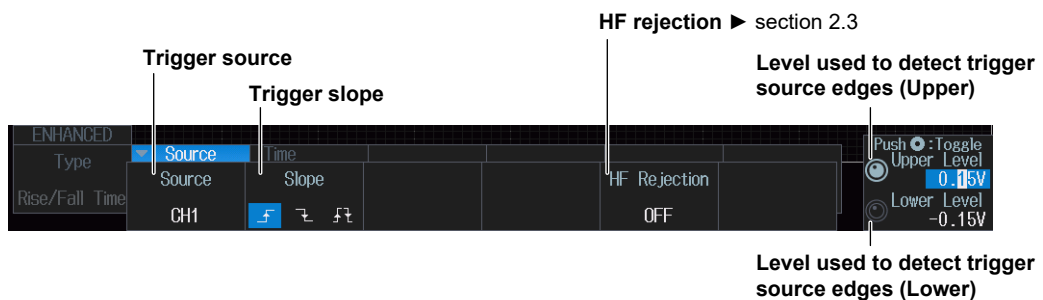

Time Condition (Time Qualification)

Set what kind of relationship must be established between the trigger source's rise or fall times and the specified reference times (Time or Time1 and Time2) for the instrument to trigger.

For details on the trigger points when the time condition is met, see chapter 4, "Triggering" in the *Features Guide* (IM DLM3054-01EN).

- More than : When the rise time or fall time is longer than the specified reference time
- Less than : When the rise time or fall time is shorter than the specified reference time
- Inside : When the rise time or fall time is longer than reference time Time1 and shorter than reference time Time2
- Outside : When the rise time or fall time is shorter than reference time Time1 or longer than reference time Time2

Reference time (Time or Time1 and Time2)

When the Time Condition is More than or Less than

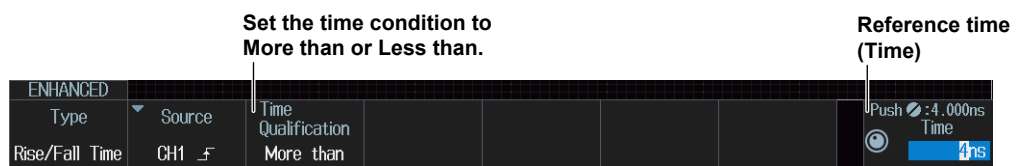

When the Time Condition is Inside or Outside

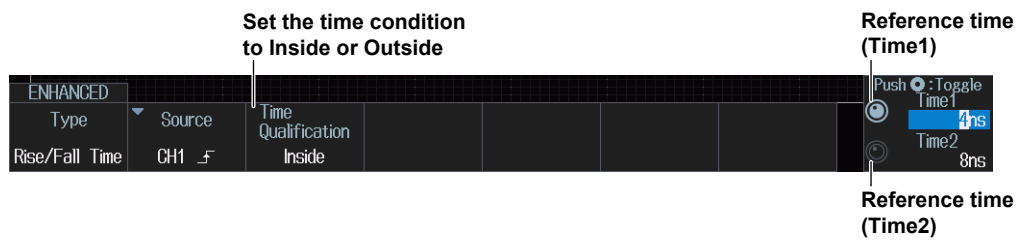

2.8 Triggering on Runt Signals

This section explains the following settings for triggering on Runt signals:

- Trigger source
Polarity, HF rejection, noise rejection, level used to detect trigger source states
- Time condition, reference time

► “Runt Trigger [ENHANCED]” in the Features Guide

ENHANCED Runt Menu

1. Press **ENHANCED**. The ENHANCED menu appears.
You can also tap **MENU** (E) in the upper left of the screen and select the ENHANCED menu from TRIGGER on the top menu that is displayed.
2. Press the **Type** soft key. Select **Runt** from the setup menu that is displayed. The following menu items appear.

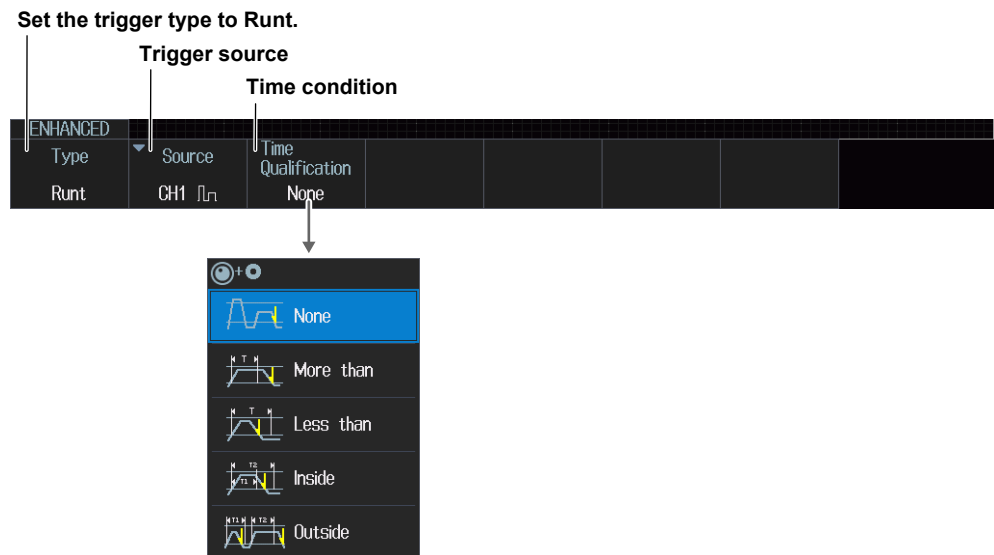

Trigger Source (Source)

Press the **Source** soft key. The following menu items appear.

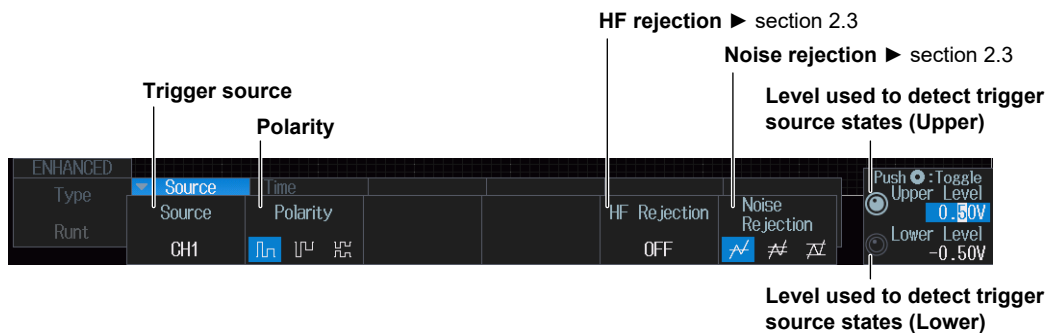

Time Condition (Time Qualification)

Set what kind of relationship must be established between the Runt signal's pulse width and the specified reference times (Time, Time1, and Time2) for the instrument to trigger.

For details on the trigger points when the time condition is met, see chapter 4, "Triggering" in the *Features Guide* (IM DLM3054-01EN).

- None : Without a time condition
- More than : When the Runt signal's pulse width is longer than the specified reference time (Time)
- Less than : When the Runt signal's pulse width is shorter than the specified reference time (Time)
- Inside : When the Runt signal's pulse width is longer than Time1 but shorter than Time2
- Outside : When the Runt signal's pulse width is shorter than Time1 or longer than Time2

Reference time (Time or Time1 and Time2)

When the Time Condition is More than or Less than

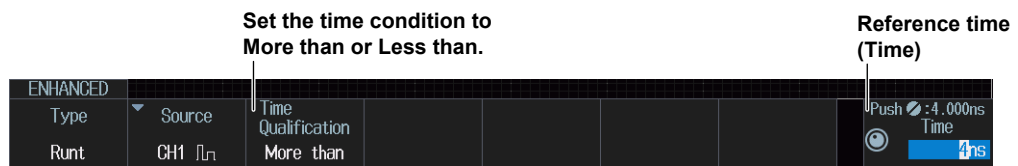

When the Time Condition is Inside or Outside

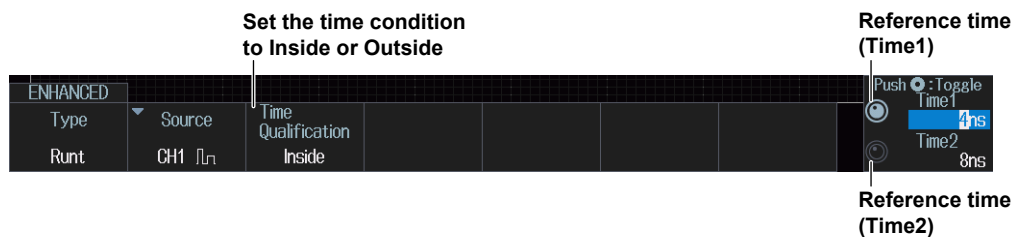

2.9 Triggering on Timeout Period

This section explains the following settings for triggering on the timeout period:

- Trigger source
Polarity, HF rejection, noise rejection, source bit, level used to detect trigger source states
- Timeout period

► [“Timeout Trigger \[ENHANCED\]” in the Features Guide](#)

ENHANCED Timeout Menu

1. Press **ENHANCED**. The ENHANCED menu appears.
You can also tap **MENU** (Ⓜ) in the upper left of the screen and select the ENHANCED menu from TRIGGER on the top menu that is displayed.
2. Press the **Type** soft key. Select **Timeout** from the setup menu that is displayed. The following menu items appear.

Set the trigger type to Timeout.



Trigger Source (Source)

Press the **Source** soft key. The menu that appears varies depending on the specified trigger source.

When the Trigger Source Is from CH1 to CH4

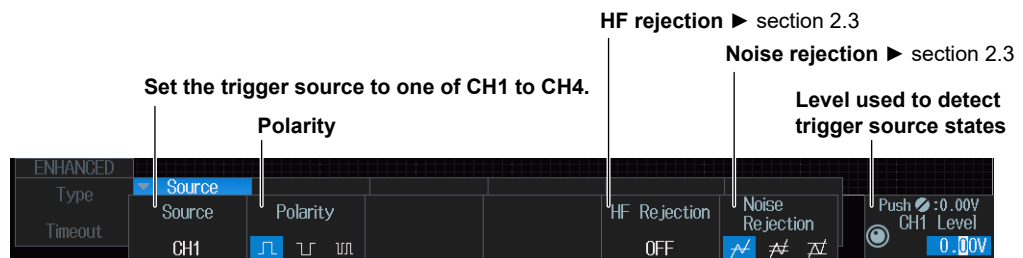

When the Trigger Source Is LOGIC (On models with the logic signal input port)

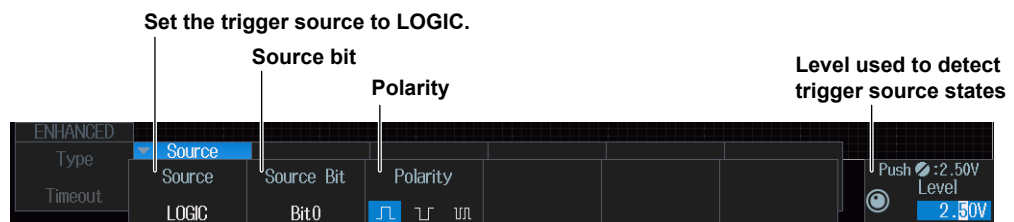

For the 701989 Logic Probe



2.10 Triggering on a Window Trigger

This section explains the following settings for triggering on a window trigger (level range):

- Trigger source
Polarity, HF rejection, noise rejection, level range for Window
- Time condition, reference time

► “Window Trigger [ENHANCED]” in the Features Guide

ENHANCED Window Menu

1. Press **ENHANCED**. The ENHANCED menu appears.
You can also tap **MENU** (Ⓜ) in the upper left of the screen and select the ENHANCED menu from TRIGGER on the top menu that is displayed.
2. Press the **Type** soft key. Select **Window** from the setup menu that is displayed. The following menu items appear.

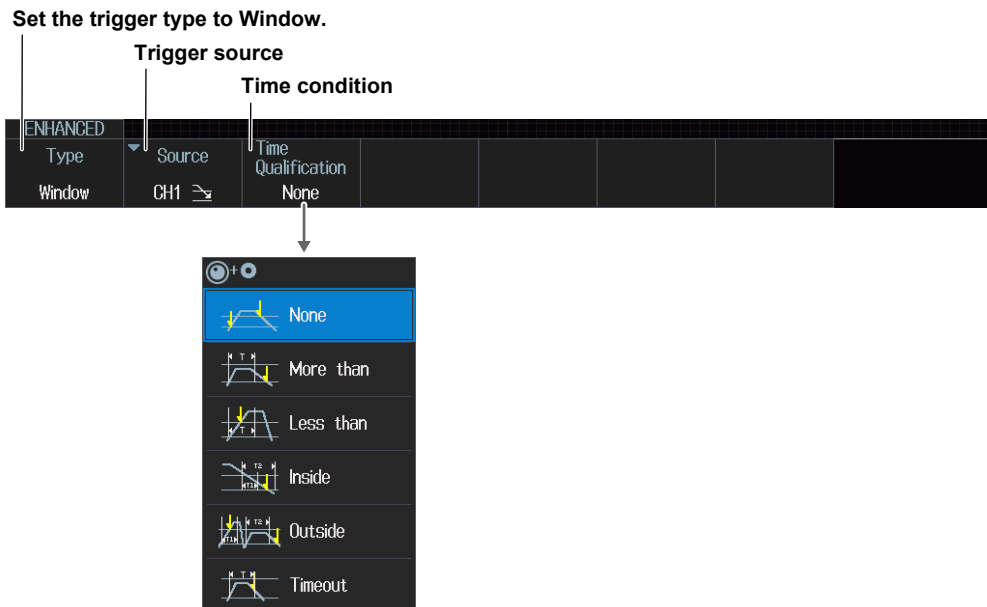

Trigger Source (Source)

Press the **Source** soft key. The following menu items appear.

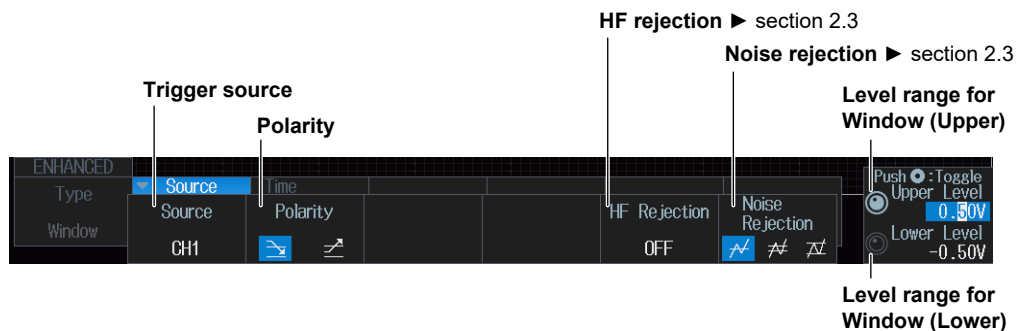

Time Condition (Time Qualification)

Set what kind of relationship must be established between the time that the waveform stays inside or outside the window and the specified reference times (Time or Time1 and Time2) for the instrument to trigger.

For details on the trigger points when the time condition is met, see chapter 4, “Triggering” in the *Features Guide* (IM DLM3054-01EN). When Timeout is selected, the instrument triggers when a timeout occurs.

- None : Without a time condition (when the waveform moves from inside the window to outside, or from outside the window to inside)
- More than : When the time that the waveform stays inside or outside the window is longer than the specified reference time (Time)
- Less than : When the time that the waveform stays inside or outside the window is shorter than the specified reference time (Time)
- Inside : When the time that the waveform stays inside or outside the window is longer than reference time Time1 and shorter than reference time Time2.
- Outside : When the time that the waveform stays inside or outside the window is shorter than reference time Time1 or longer than reference time Time2.
- Timeout : When the time that the waveform stays inside or outside the window is longer than the specified reference time (Time)

Reference time (Time or Time1 and Time2)

When the Time Condition is More than, Less than, or Timeout

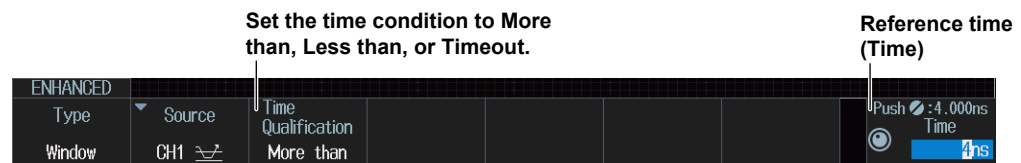

When the Time Condition is Inside or Outside

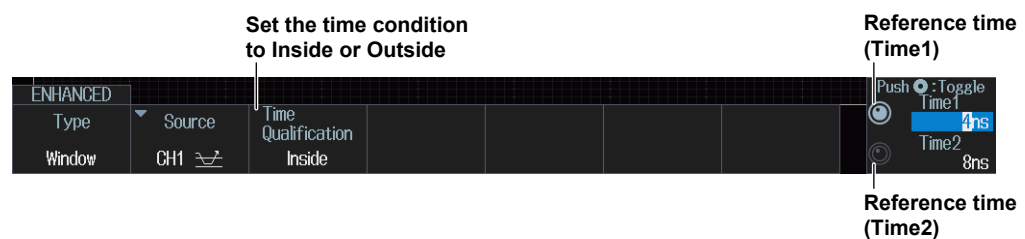

2.11 Triggering on the OR of Multiple Window Triggers

This section explains the following settings for triggering on the logical OR of multiple window triggers (without a time condition):

- Trigger source pattern
 - Trigger source, polarity
- Trigger level
 - Level range for Window, HF rejection, noise rejection

► [“Window OR Trigger \[ENHANCED\]” in the Features Guide](#)

ENHANCED Window OR Menu

1. Press **ENHANCED**. The ENHANCED menu appears.
You can also tap **MENU** (Ⓜ) in the upper left of the screen and select the ENHANCED menu from TRIGGER on the top menu that is displayed.
2. Press the **Type** soft key. Select **Window OR** from the setup menu that is displayed. The following menu items appear.



Trigger Source Pattern (Pattern)

Press the **Pattern** soft key. The following menu items appear.

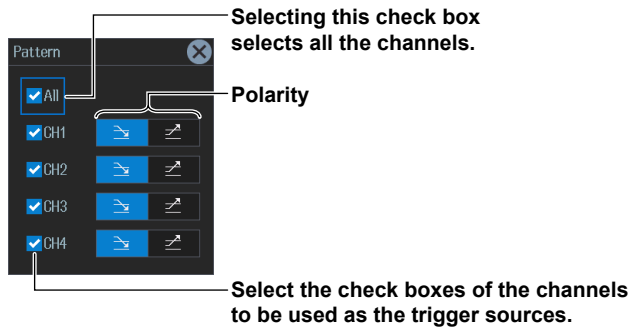

Trigger Levels (Levels)

Press the **Levels** soft key. The following menu items appear.

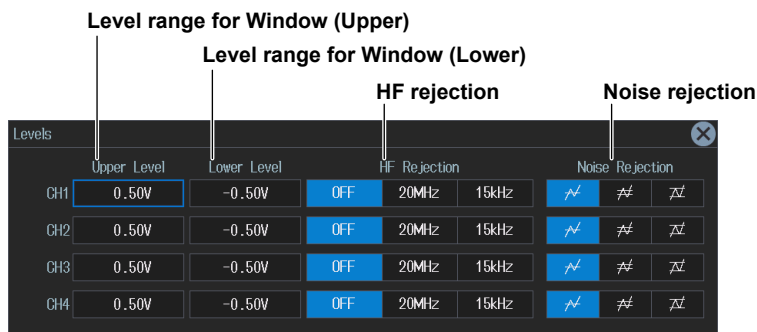

2.12 Triggering on Edge Intervals

This section explains the following settings for triggering on edge intervals:

- Trigger source
Trigger slope HF rejection, noise rejection, source bit, level used to detect trigger source edges
- Time condition, reference time

► “Interval Trigger [ENHANCED]” in the Features Guide

ENHANCED Interval Menu

1. Press **ENHANCED**. The ENHANCED menu appears.
You can also tap **MENU** (ⓘ) in the upper left of the screen and select the ENHANCED menu from TRIGGER on the top menu that is displayed.
2. Press the **Type** soft key. Select **Interval** from the setup menu that is displayed. The following menu items appear.

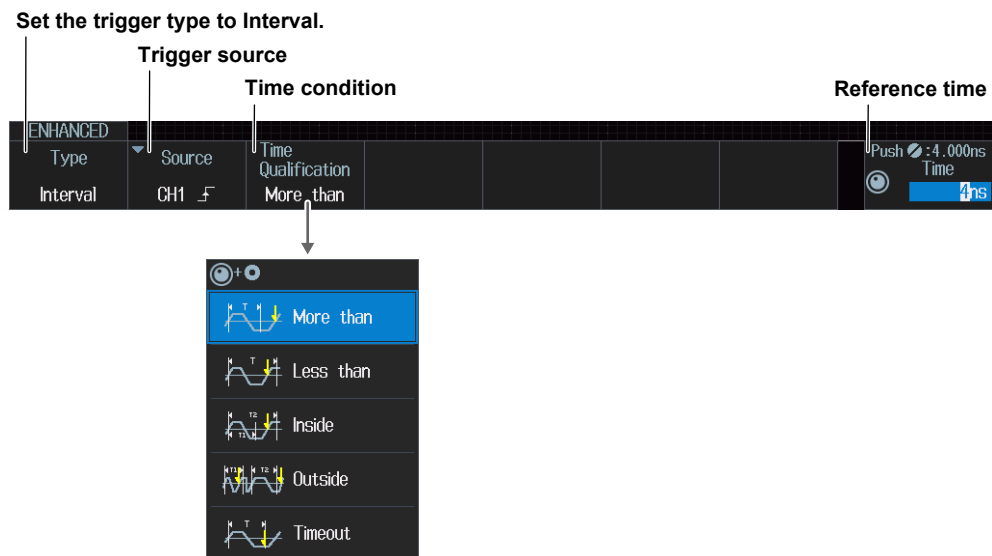

Trigger Source (Source)

Press the **Source** soft key. The menu that appears varies depending on the specified trigger source.

When the Trigger Source Is from CH1 to CH4

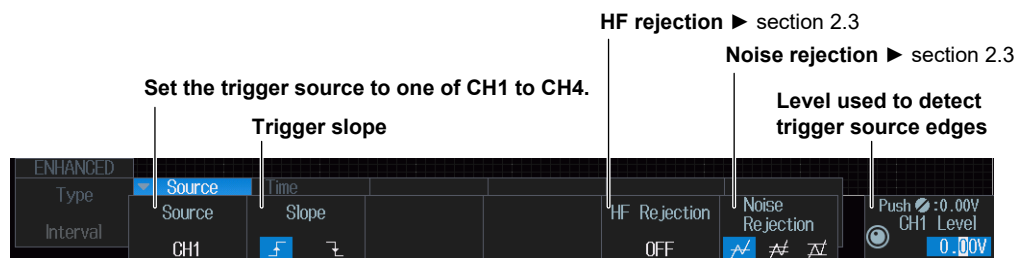

2.12 Triggering on Edge Intervals

When the Trigger Source Is LOGIC (On models with the logic signal input port)

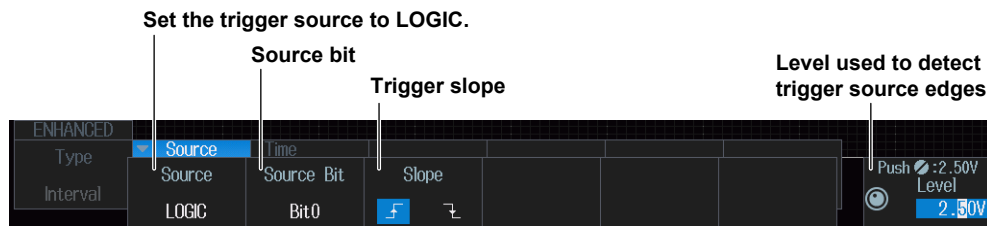

Time Condition (Time Qualification)

Set what kind of relationship must be established between the interval between two consecutive edges (rising or falling) and the specified reference times (Time or Time1 and Time2) for the instrument to trigger.

For details on the trigger points when the time condition is met, see chapter 4, “Triggering” in the *Features Guide* (IM DLM3054-01EN). When Timeout is selected, the instrument triggers when a timeout occurs.

More than : When the edge interval is longer than the specified reference time (Time)

Less than : When the edge interval is shorter than the specified reference time (Time)

Inside : When the edge interval is longer than Time1 but shorter than Time2

Outside : When the edge interval is shorter than Time1 or longer than Time2

Timeout : When the edge interval is longer than the specified reference time (Time)

Reference time (Time or Time1 and Time2)

When the Time Condition is More than, Less than, or Timeout



When the Time Condition is Inside or Outside

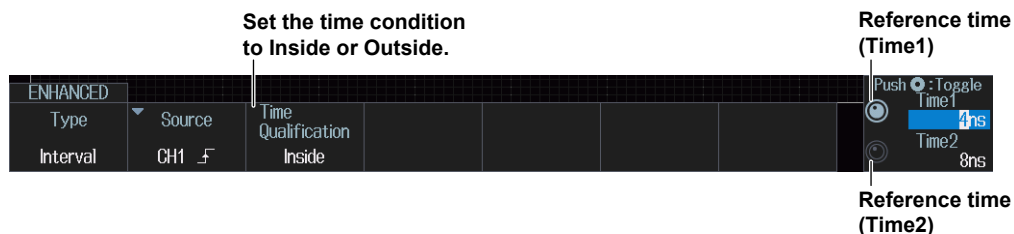

2.13 Triggering on FlexRay Bus Signals (Option)

This section explains the following settings for triggering on FlexRay bus signals:

- Trigger source
Bit rate, bus channel assignment, HF rejection
- Trigger mode
Trigger condition
- Level used to detect trigger source states, hysteresis

► [“FlexRay Bus Trigger \[ENHANCED, option\]” in the Features Guide](#)

Auto Setup

The instrument can automatically set the trigger source level and bit rate from the received FlexRay bus signal and trigger on them. For details, see section 12.1.

ENHANCED FlexRay Menu

1. Press **ENHANCED**. The ENHANCED menu appears.
You can also tap **MENU** (☰) in the upper left of the screen and select the ENHANCED menu from TRIGGER on the top menu that is displayed.
2. Press the **Type** soft key. Select **FlexRay** from the setup menu that is displayed. The following menu items appear.

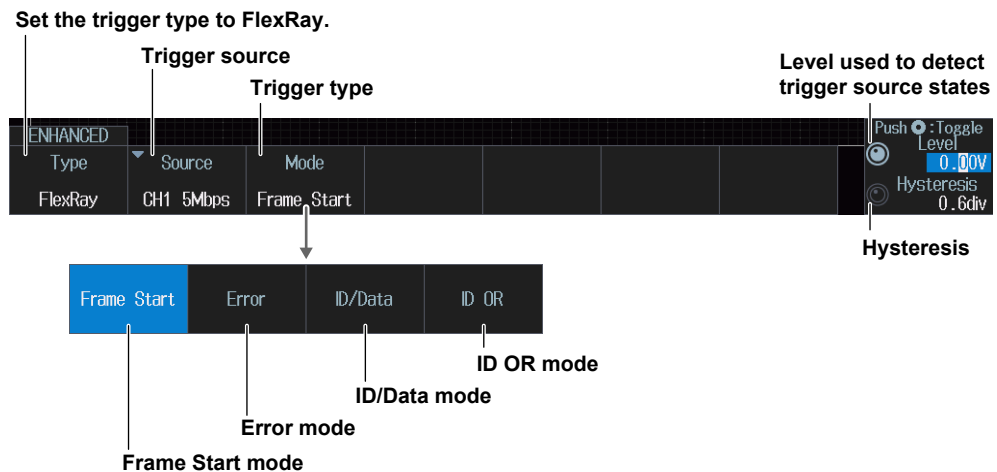

Trigger Source (Source)

Press the **Source** soft key. The following menu items appear.

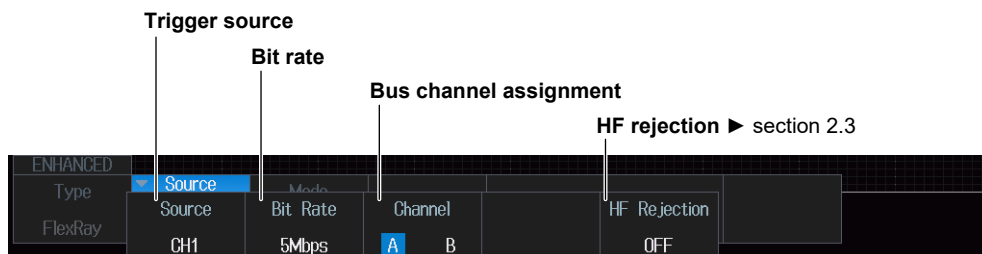

Trigger Mode (Mode)

Frame Start Mode (Frame Start)

Press the **Mode** soft key and then the **Frame Start** soft key. The instrument triggers on the start of FlexRay bus signal frames.

Error Mode (Error)

Press the **Mode** soft key and then the **Error** soft key. The following menu items appear.

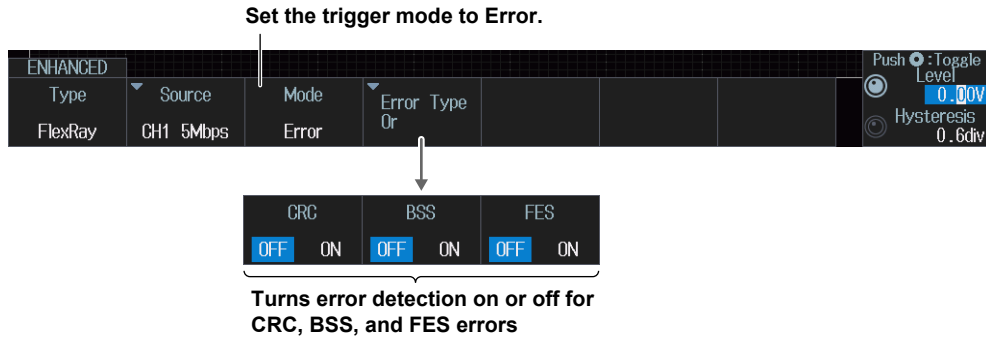

ID/Data Mode (ID/Data)

Press the **Mode** soft key and then the **ID/Data** soft key. The following menu items appear.

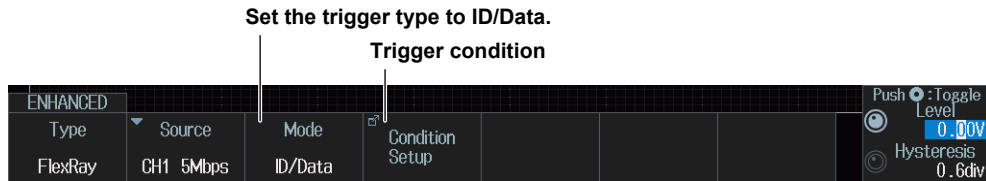

Trigger Condition (Condition Setup)

Press the **Condition Setup** soft key. The following screen appears. The instrument triggers on the AND of Frame Start, Indicator, ID, Cycle Count, Data1, and Data2. Items whose check boxes are selected are used as trigger conditions.

- When the Comparison Condition of Data1 Is True or False

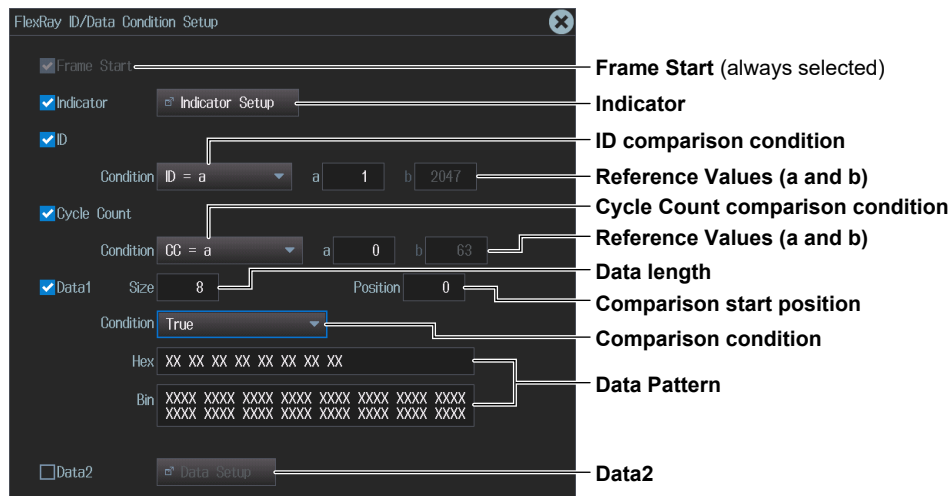

- When the Comparison Condition of Data1 Is Data = a; Data ≠ a; a ≤ Data; Data ≤ b; a ≤ Data ≤ b; or Data < a, b < Data

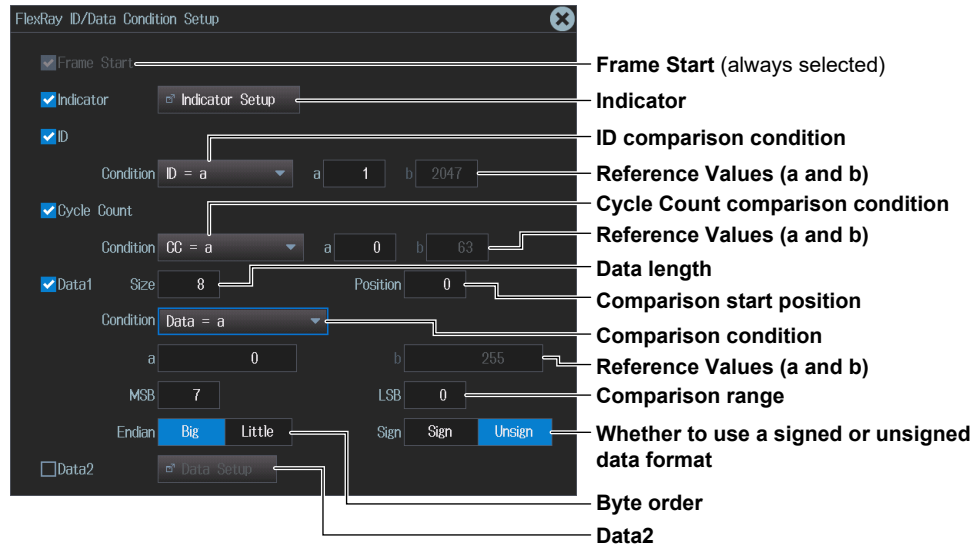

ID OR Mode (ID OR)

Press the **Mode** soft key and then the **ID OR** soft key. The following menu items appear.

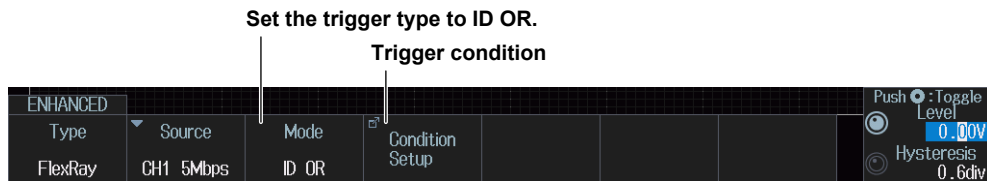

Trigger Condition (Condition Setup)

Press the **Condition Setup** soft key. The following screen appears.

The instrument triggers when the condition of one of the four IDs is met. Items whose check boxes are selected are used as trigger conditions.

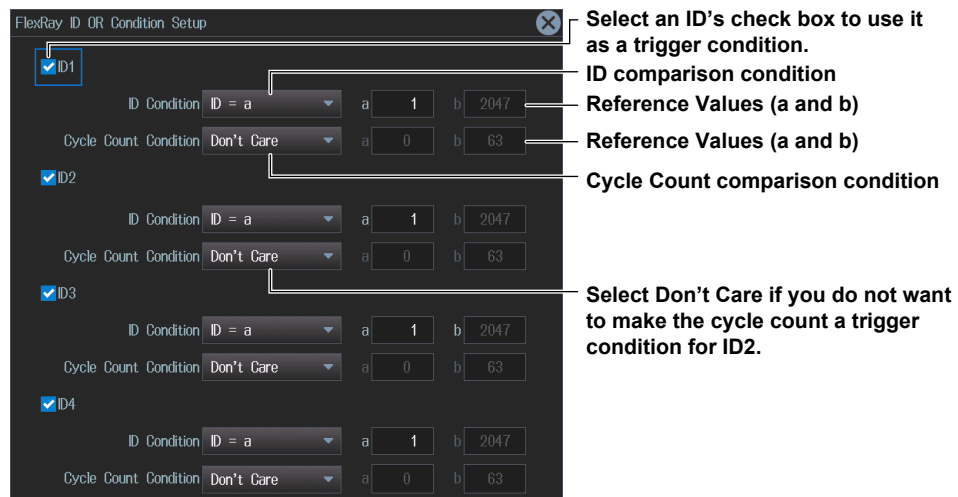

2.14 Triggering on CAN Bus Signals (Option)

This section explains the following settings for triggering on CAN bus signals:

- Trigger source
 - Bit rate, recessive level, HF rejection, sample point
- Trigger mode
 - Trigger condition
- Level used to detect trigger source states, hysteresis

► [“CAN Bus Trigger \[ENHANCED, option\]” in the Features Guide](#)

Auto Setup

The instrument can automatically set the trigger source level and bit rate from the received CAN bus signal and trigger on them. For details, see section 12.2.

ENHANCED CAN Menu

1. Press **ENHANCED**. The ENHANCED menu appears.
You can also tap **MENU** (E) in the upper left of the screen and select the ENHANCED menu from TRIGGER on the top menu that is displayed.
2. Press the **Type** soft key. Select **CAN** from the setup menu that is displayed. The following menu items appear.

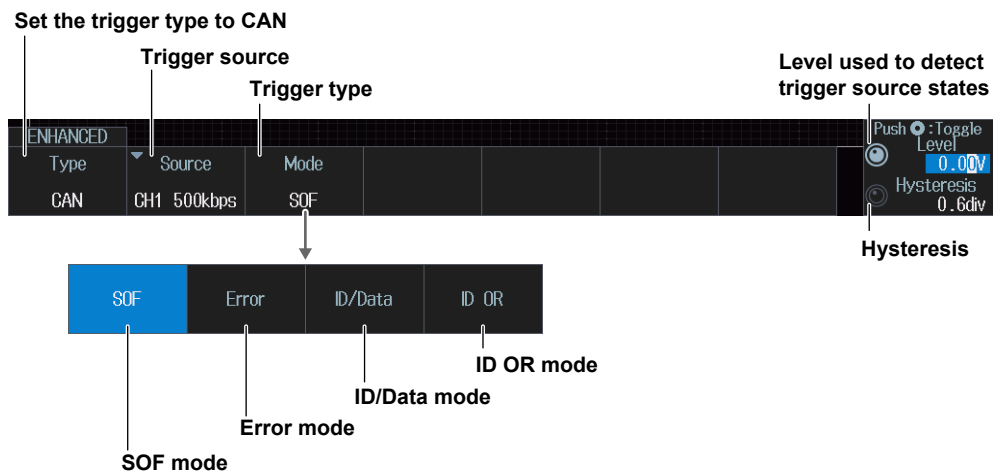

Trigger Source (Source)

Press the **Source** soft key. The following menu items appear.



When the bit rate is set to User Define



Trigger Mode (Mode)

SOF (Start of Frame) Mode

Press the **Mode** soft key and then the **SOF** soft key. The instrument triggers on the start of CAN bus signal frames.

Error Mode (Error)

Press the **Mode** soft key and then the **Error** soft key. The following menu items appear.

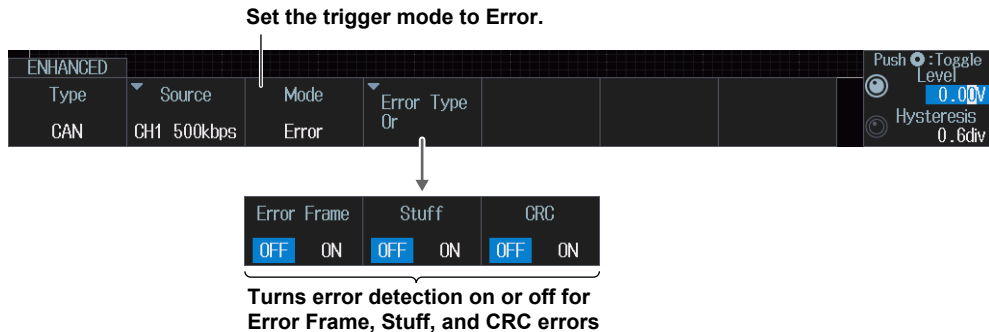

The instrument triggers on error frames (when the error flag is active) or when it detects any of various errors.

ID/Data Mode (ID/Data)

Press the **Mode** soft key and then the **ID/Data** soft key. The following menu items appear.

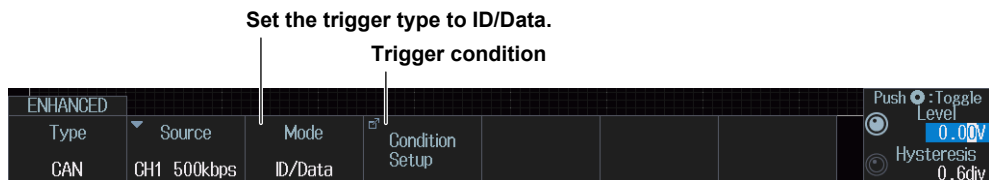

2.14 Triggering on CAN Bus Signals (Option)

Trigger Condition (Condition Setup)

Press the **Condition Setup** soft key. The following screen appears.

The instrument triggers on the AND of the SOF, ID, frame type (Remote Frame or Data Frame), Data, and ACK Mode conditions. Items whose check boxes are selected are used as trigger conditions.

- **When ID Input Format Is Pattern**

When the Comparison Condition Is True or False

The screenshot shows the 'CAN ID/Data Condition Setup' window. The 'Frame Format' is set to 'Standard'. The 'SOF' checkbox is checked. The 'ID' checkbox is checked, and the 'Input Format' is set to 'Pattern'. The 'Hex' field contains 'X XX' and the 'Bin' field contains 'XXX XXXX XXXX'. The 'Remote Frame' checkbox is unchecked, and the 'Data Frame' checkbox is checked. The 'DLC' is set to '8'. The 'Condition' dropdown is set to 'True'. The 'Hex' field contains 'XX XX XX XX XX XX XX XX' and the 'Bin' field contains two lines of 'XXXX XXXX XXXX XXXX XXXX XXXX XXXX XXXX'. The 'ACK Mode' is set to 'ACK'.

Annotations on the right side of the screenshot:

- Frame format
- SOF (always selected)
- Set the ID input format to Pattern.
- Bit pattern of ID (If you select Extend for the frame format, 29 bits are displayed here)
- Set the trigger source frame
- Data length for the data field
- Comparison condition
- Data Pattern
- ACK slot state

When the comparison condition is Data = a; Data ≠ a; a ≤ Data; Data ≤ b; a ≤ Data ≤ b; or Data < a, b < Data

The screenshot shows the 'CAN ID/Data Condition Setup' window. The 'Frame Format' is set to 'Standard'. The 'SOF' checkbox is checked. The 'ID' checkbox is checked, and the 'Input Format' is set to 'Pattern'. The 'Hex' field contains 'X XX' and the 'Bin' field contains 'XXX XXXX XXXX'. The 'Remote Frame' checkbox is unchecked, and the 'Data Frame' checkbox is checked. The 'DLC' is set to '8'. The 'Condition' dropdown is set to 'Data = a'. The 'a' field contains '0' and the 'b' field contains '255'. The 'MSB' is set to '7' and the 'LSB' is set to '0'. The 'Endian' is set to 'Big' and the 'Sign' is set to 'Unsign'. The 'ACK Mode' is set to 'ACK'.

Annotations on the right side of the screenshot:

- Frame format
- SOF (always selected)
- Set the ID input format to Pattern.
- Bit pattern of ID (If you select Extend for the frame format, 29 bits are displayed here)
- Set the trigger source frame
- Data length for the data field
- Comparison condition
- Reference Values (a and b)
- Bit positions of the most significant bit (MSB) and the least significant bit (LSB) in the data to be compared
- Whether to use a signed (Sign) or unsigned (Unsign) data format
- byte order
- ACK slot state

• When ID Input Format Is Message

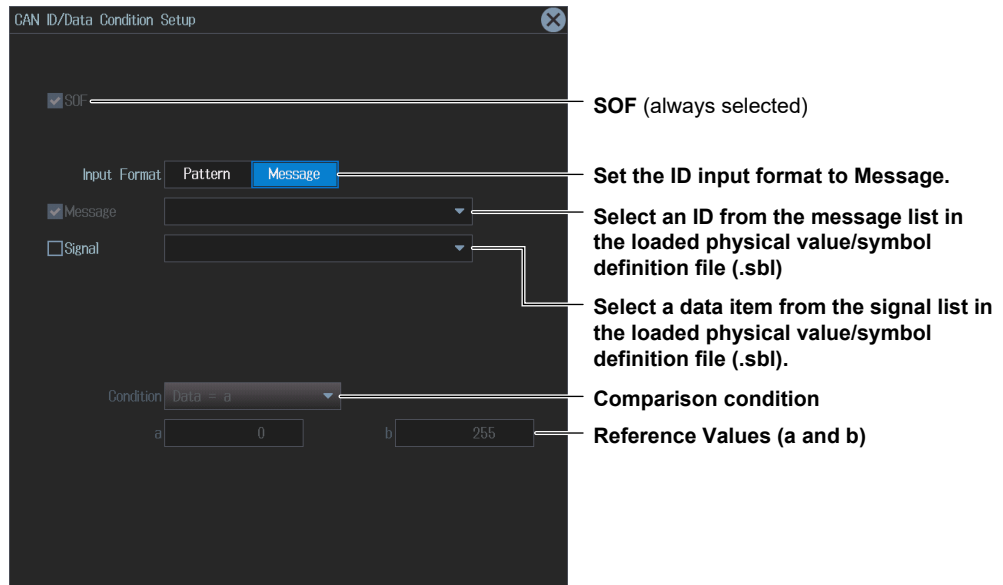

ID OR Mode (ID OR)

Press the **Mode** soft key and then the **ID OR** soft key. The following menu items appear.

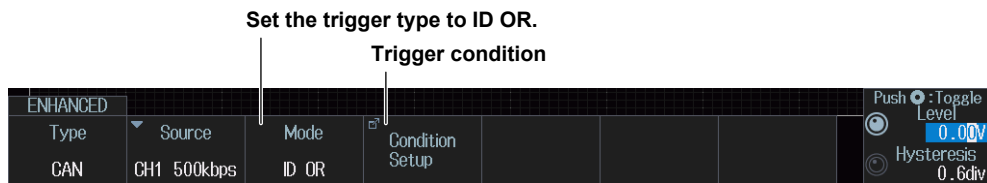

Trigger Condition (Condition Setup)

Press the **Condition Setup** soft key. The following screen appears.

The instrument triggers on the AND of the SOF, any of the four IDs, frame type (Remote Frame or Data Frame), and ACK Mode conditions. Items whose check boxes are selected are used as trigger conditions.

• When ID Input Format Is Pattern

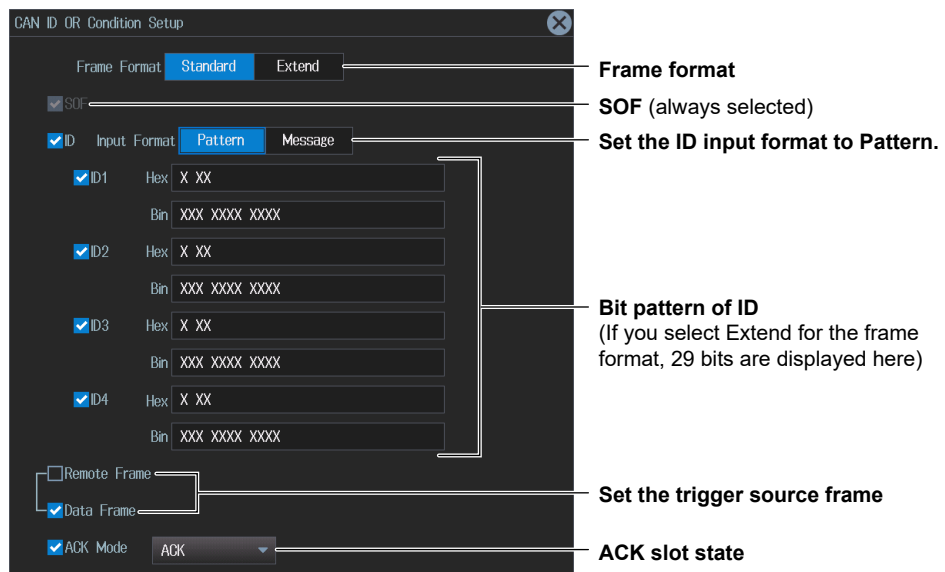

2.14 Triggering on CAN Bus Signals (Option)

- When ID Input Format Is Message

Frame Format: **Standard** | Extend

SOF

ID Input Format: **Message** | Pattern

ID1

ID2

ID3

ID4

SOF (always selected)

Set the ID input format to Message.

Select IDs from the list of messages loaded from the physical value/symbol definition file (.sbl)

2.15 Triggering on CAN FD Bus Signals (Option)

This section explains the following settings for triggering on CAN FD bus signals:

- Trigger source
Bit rate, sample point, data phase bit rate, data phase sample point, recessive level, HF rejection
- Trigger mode
Trigger condition
- CAN FD standard
- Level used to detect trigger source states, hysteresis

► [“CAN FD Bus Trigger \[ENHANCED, option\]” in the Features Guide](#)

Auto Setup

The instrument can automatically set the trigger source level and bit rate from the received CAN FD bus signal and trigger on them. For details, see section 12.3.

ENHANCED CAN FD Menu

1. Press **ENHANCED**. The ENHANCED menu appears.
You can also tap **MENU** (ⓘ) in the upper left of the screen and select the ENHANCED menu from TRIGGER on the top menu that is displayed.
2. Press the **Type** soft key. Select **CAN FD** from the setup menu that is displayed. The following menu items appear.

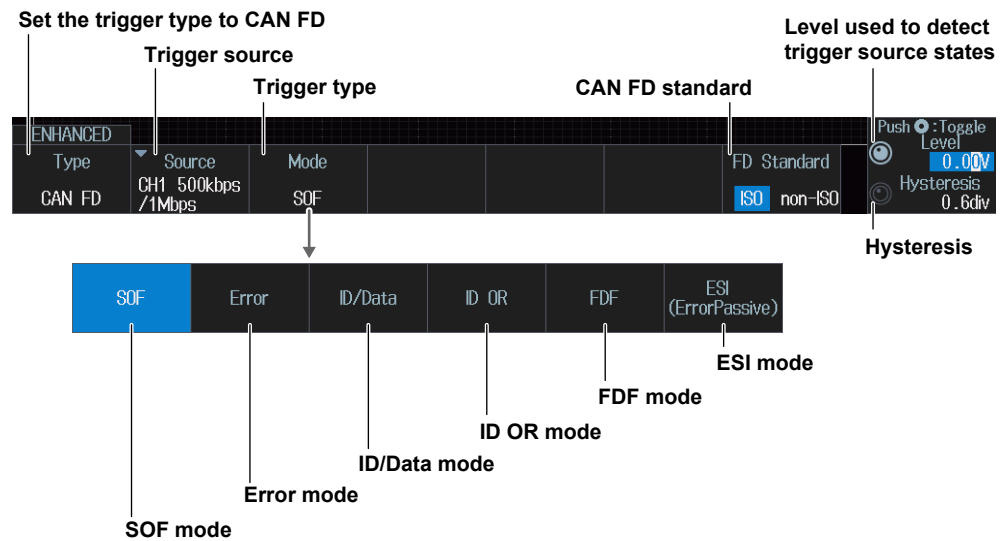

Trigger Source (Source)

Press the **Source** soft key. The following menu items appear.

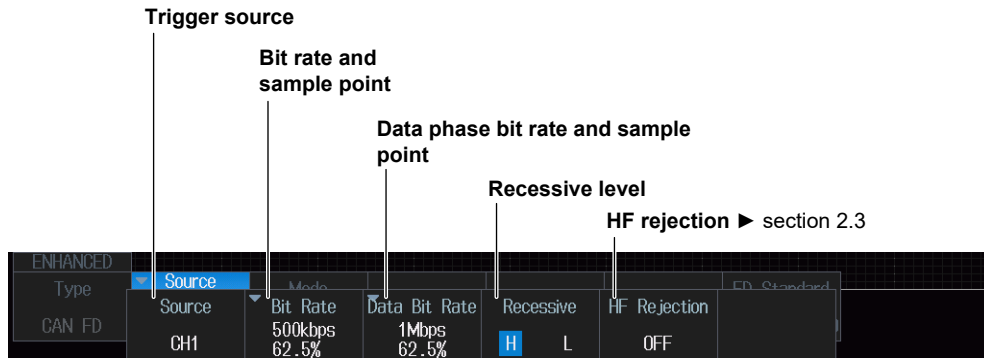

Bit Rate (Bit Rate) and Sample Point (Sample Point)

Press the **Bit Rate** soft key. The following menu items appear.

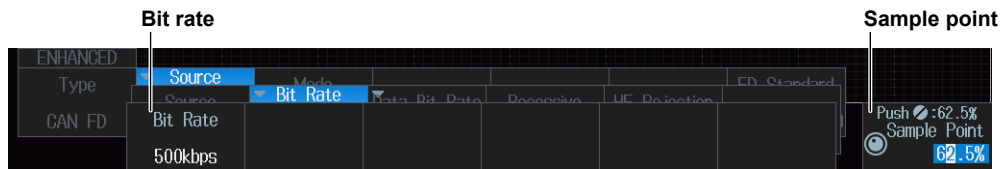

When the bit rate is set to User Define



Data Phase Bit Rate (Data Bit Rate) and Sample Point (Sample Point)

Press the **Data Bit Rate** soft key. The following menu items appear.

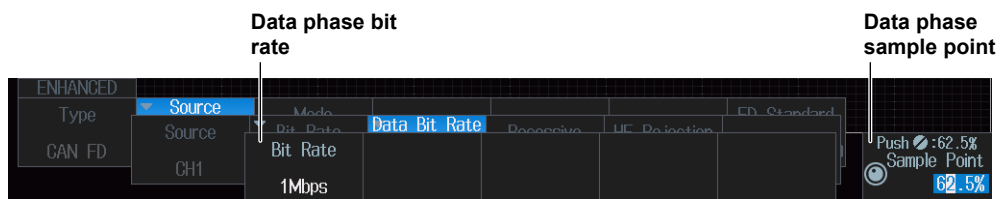

When the data phase bit rate is set to User Define

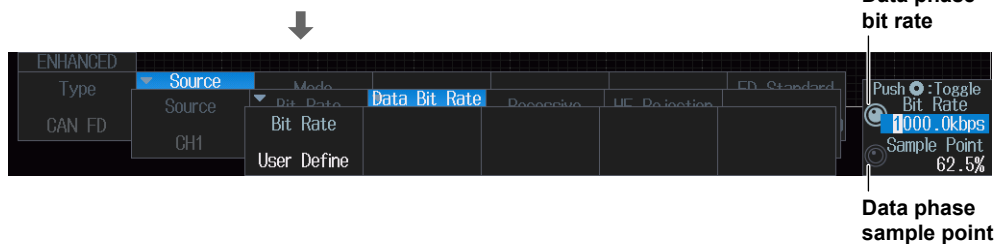

Trigger Mode (Mode)

SOF (Start of Frame) Mode

Press the **Mode** soft key and then the **SOF** soft key.

The instrument triggers on the start of CAN FD bus signal frames.

Error Mode (Error)

Press the **Mode** soft key and then the **Error** soft key. The following menu items appear.

Set the trigger mode to Error.

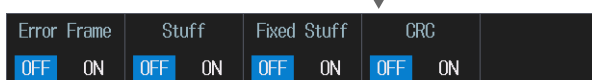

Turns error detection on or off for Error Frame, Stuff, Fixed Stuff, and CRC errors

When the CAN FD standard* is set to ISO

When CRC is set to ON

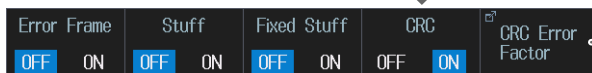

Select the check boxes for the CRC error factors to detect.

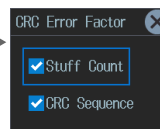

CRC errors are not detected if both check boxes are cleared.

When the CAN FD standard* is set to non-ISO

When CRC is set to ON

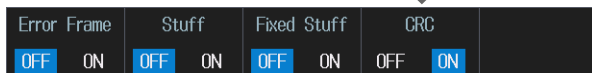

* CAN FD standard setting ► page 2-31

The instrument triggers on error frames (when the error flag is active) or when it detects various errors.

ID/Data Mode (ID/Data)

Press the **Mode** soft key and then the **ID/Data** soft key. The following menu items appear.

Set the trigger type to ID/Data.

Trigger condition



2.15 Triggering on CAN FD Bus Signals (Option)

Trigger Condition (Condition Setup)

Press the **Condition Setup** soft key. The following screen appears.

The instrument triggers on the AND of the SOF, ID, frame type (Remote Frame or Data Frame), Data, and ACK Mode conditions. Items whose check boxes are selected are used as trigger conditions.

- **When ID Input Format Is Pattern**

When the Comparison Condition Is True or False

The screenshot shows the 'CAN FD ID/Data Condition Setup' dialog box. The following elements are annotated with lines pointing to their respective labels:

- Frame format:** Points to the 'Standard' and 'Extend' radio buttons.
- SOF (always selected):** Points to the checked 'SOF' checkbox.
- Set the ID input format to Pattern:** Points to the checked 'ID' checkbox.
- Bit pattern of ID:** Points to the 'Input Format' dropdown menu, which is set to 'Pattern'.
- Bit pattern of ID (If you select Extend for the frame format, 29 bits are displayed here):** Points to the 'Hex' and 'Bin' input fields for the ID.
- Set the trigger source frame:** Points to the 'Remote Frame' and 'Data Frame' checkboxes, with 'Data Frame' being checked.
- Comparison size:** Points to the 'Size' input field, which is set to '8'.
- Comparison start position:** Points to the 'Position' input field, which is set to '0'.
- Comparison condition:** Points to the 'Condition' dropdown menu, which is set to 'True'.
- Data Pattern:** Points to the 'Hex' and 'Bin' input fields for the data pattern.
- ACK slot state:** Points to the 'ACK Mode' dropdown menu, which is set to 'ACK'.

When the comparison condition is Data = a; Data ≠ a; a ≤ Data; Data ≤ b; a ≤ Data ≤ b; or Data < a, b < Data

The screenshot shows the 'CAN FD ID/Data Condition Setup' dialog box. The following elements are annotated with lines pointing to their respective labels:

- Frame format:** Points to the 'Standard' and 'Extend' radio buttons.
- SOF (always selected):** Points to the checked 'SOF' checkbox.
- Set the ID input format to Pattern:** Points to the checked 'ID' checkbox.
- Bit pattern of ID:** Points to the 'Input Format' dropdown menu, which is set to 'Pattern'.
- Bit pattern of ID (If you select Extend for the frame format, 29 bits are displayed here):** Points to the 'Hex' and 'Bin' input fields for the ID.
- Set the trigger source frame:** Points to the 'Remote Frame' and 'Data Frame' checkboxes, with 'Data Frame' being checked.
- Comparison size:** Points to the 'Size' input field, which is set to '8'.
- Comparison start position:** Points to the 'Position' input field, which is set to '0'.
- Comparison condition:** Points to the 'Condition' dropdown menu, which is set to 'Data = a'.
- Reference Values (a and b):** Points to the 'a' and 'b' input fields, which are set to '0' and '255' respectively.
- Bit positions of the most significant bit (MSB) and the least significant bit (LSB) in the data to be compared:** Points to the 'MSB' and 'LSB' input fields, which are set to '7' and '0' respectively.
- Whether to use a signed (Sign) or unsigned (Unsign) data format:** Points to the 'Sign' and 'Unsign' radio buttons, with 'Unsign' being selected.
- Byte order:** Points to the 'Endian' dropdown menu, which is set to 'Big'.
- ACK slot state:** Points to the 'ACK Mode' dropdown menu, which is set to 'ACK'.

• When ID Input Format Is Message

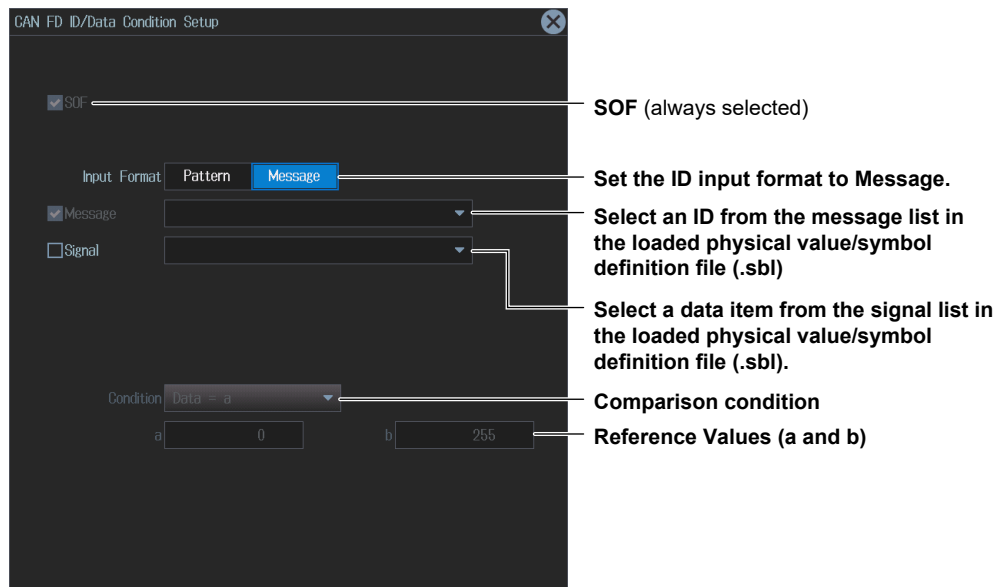

ID OR Mode (ID OR)

Press the **Mode** soft key and then the **ID OR** soft key. The following menu items appear.

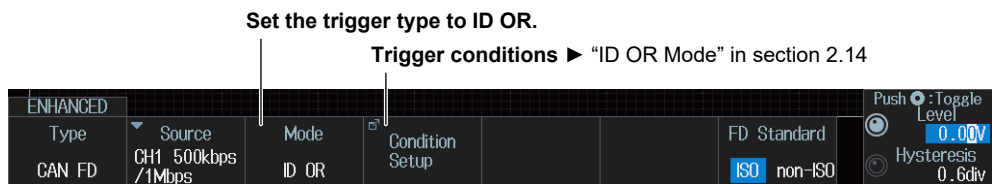

2.15 Triggering on CAN FD Bus Signals (Option)

FDF Mode (FDF)

Press the **Mode** soft key and then the **FDF** soft key. The following menu items appear.

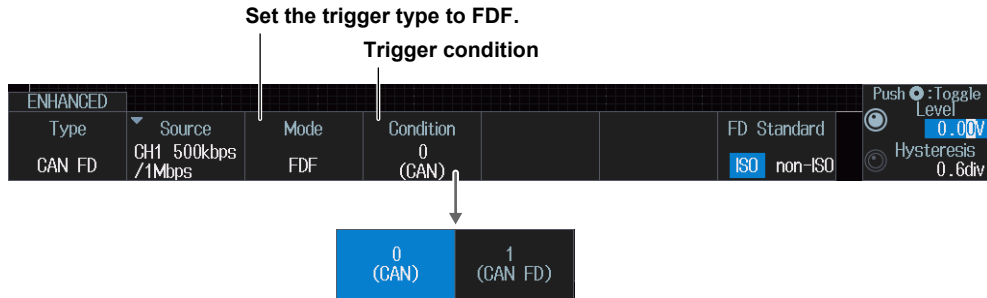

Trigger Condition (Condition)

Set the FDF bit state as a trigger condition.

- 0 (CAN): When the FDF bit is dominant, the instrument assumes that the frame is a CAN bus signal frame and triggers.
- 1 (CAN FD): When the FDF bit is recessive, the instrument assumes that the frame is a CAN FD bus signal frame and triggers on it.

ESI Mode (ESI (ErrorPassive))

Press the **Mode** soft key and then the **ESI (ErrorPassive)** soft key.

The instrument triggers when the ESI bit is recessive (error passive).

2.16 Triggering on LIN Bus Signals (Option)

This section explains the following settings for triggering on LIN bus signals:

- Trigger source
 - Bit rate, HF rejection, sample point
- Trigger mode
 - Trigger condition
- Level used to detect trigger source states, hysteresis

▶ “LIN Bus Trigger [ENHANCED, option]” in the Features Guide

Auto Setup

The instrument can automatically set the trigger source level and bit rate from the received LIN bus signal and trigger on them. For details, see section 12.4.

ENHANCED LIN Menu

1. Press **ENHANCED**. The ENHANCED menu appears.
You can also tap **MENU** (M) in the upper left of the screen and select the ENHANCED menu from TRIGGER on the top menu that is displayed.
2. Press the **Type** soft key. Select **LIN** from the setup menu that is displayed. The following menu items appear.

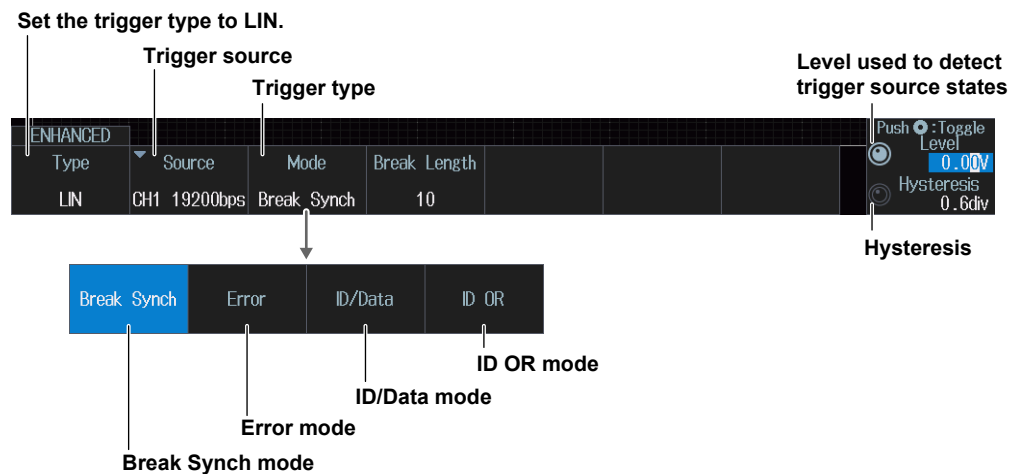

Trigger Source (Source)

Press the **Source** soft key. The following menu items appear.

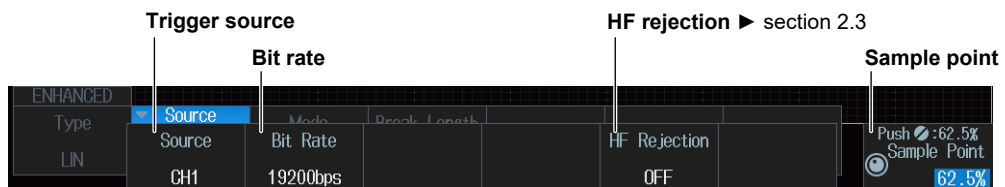

When the bit rate is set to User Define

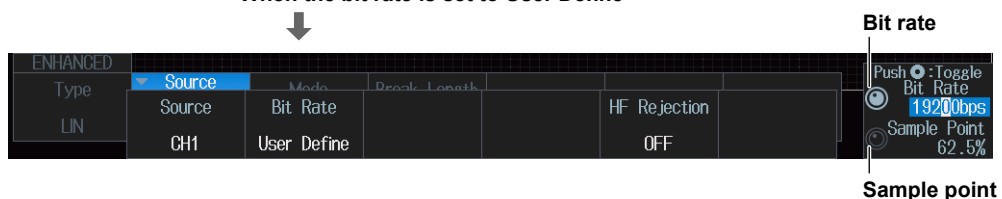

Trigger Mode (Mode)

Break Synch Mode

Press the **Mode** soft key and then the **Break Synch** soft key. The following menu items appear.

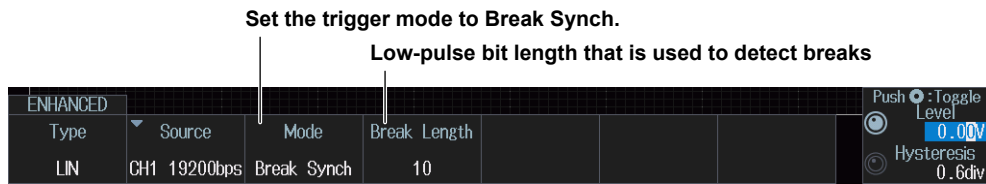

The instrument triggers when it detects a break field and then a synch field (Break Field + Synch Field).

Error Mode

Press the **Mode** soft key and then the **Error** soft key. The following menu items appear.

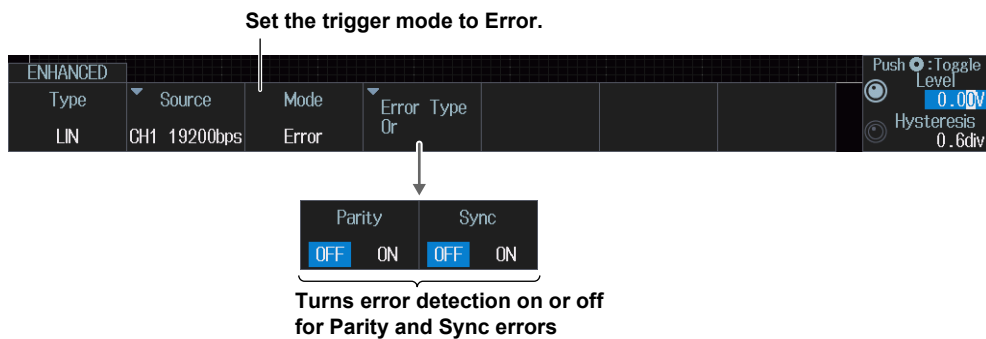

The instrument triggers when it detects an error.

ID/Data Mode

Press the **Mode** soft key and then the **ID/Data** soft key. The following menu items appear.

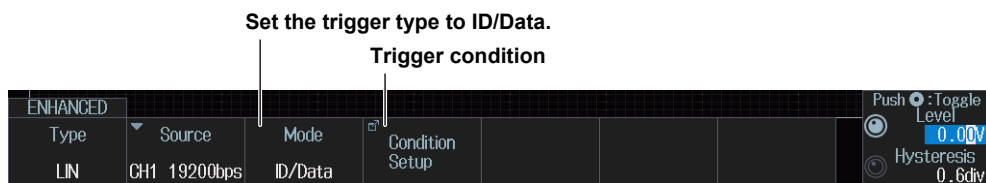

Trigger Condition (Condition Setup)

Press the **Condition Setup** soft key. The following screen appears.

The instrument triggers on the AND of the Break Synch, ID, and Data Frame conditions. Items whose check boxes are selected are used as trigger conditions.

- **When the Comparison Condition Is True or False**

The screenshot shows the 'LIN ID/Data Condition Setup' dialog with the following settings:

- Break Synch(10bit)
- ID
 - Hex: XX
 - Bin: XX XXXX
- Data Frame
 - Size: 8
 - Condition: True
 - Hex: XX XX XX XX XX XX XX XX
 - Bin: XXXX XXXX XXXX XXXX XXXX XXXX XXXX XXXX

Annotations on the right side of the dialog:

- Break Synch (always selected)
- Bit pattern of ID
- Data length
- Comparison condition
- Data Pattern

- **When the Comparison Condition Is Data = a; Data ≠ a; a ≤ Data; Data ≤ b; a ≤ Data ≤ b; or Data < a, b < Data**

The screenshot shows the 'LIN ID/Data Condition Setup' dialog with the following settings:

- Break Synch(10bit)
- ID
 - Hex: XX
 - Bin: XX XXXX
- Data Frame
 - Size: 8
 - Condition: Data = a
 - a: 0
 - b: 255
 - MSB: 7
 - LSB: 0
 - Endian: Big
 - Sign: Unsign

Annotations on the right side of the dialog:

- Break Synch (always selected)
- Bit pattern of ID
- Data length
- Comparison condition
- Reference Values (a and b)
- Bit positions of the most significant bit (MSB) and the least significant bit (LSB) in the data to be compared
- Whether to use a signed (Sign) or unsigned (Unsign) data format
- byte order

2.16 Triggering on LIN Bus Signals (Option)

ID OR Mode

Press the **Mode** soft key and then the **ID OR** soft key. The following menu items appear.

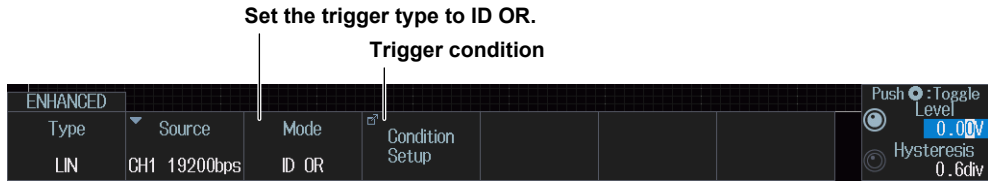

Trigger Condition (Condition Setup)

Press the **Condition Setup** soft key. The following screen appears.

The instrument triggers on the AND of the Break Synch condition and the condition of one of the four IDs. Items whose check boxes are selected are used as trigger conditions.

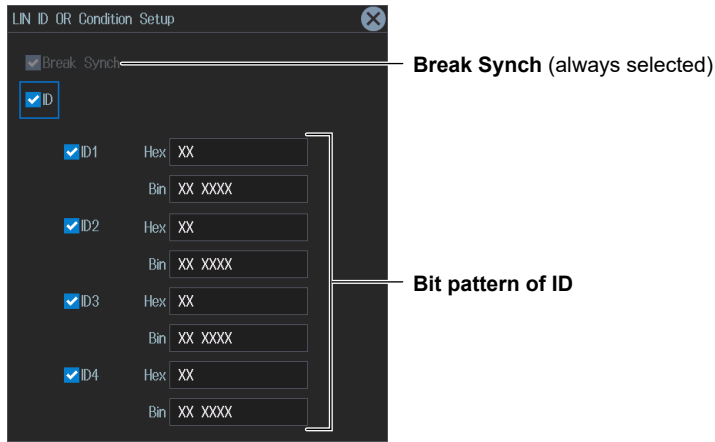

2.17 Triggering on CXPI Bus Signals (Option)

This section explains the following settings for triggering on CXPI bus signals.

- Trigger source
Bit rate, T Sample, clock tolerance, HF rejection
- Trigger mode
Trigger condition
- Level used to detect trigger source states, hysteresis

▶ [“CXPI Bus Trigger \[ENHANCED, option\]” in the Features Guide](#)

Auto Setup

The instrument can automatically set the trigger source level and bit rate from the received CXPI bus signal and trigger on them. For details, see section 12.5.

ENHANCED CXPI Menu

1. Press **ENHANCED**. The ENHANCED menu appears.
You can also tap **MENU** (ⓘ) in the upper left of the screen and select the ENHANCED menu from TRIGGER on the top menu that is displayed.
2. Press the **Type** soft key. Select **CXPI** from the setup menu that is displayed. The following menu items appear.

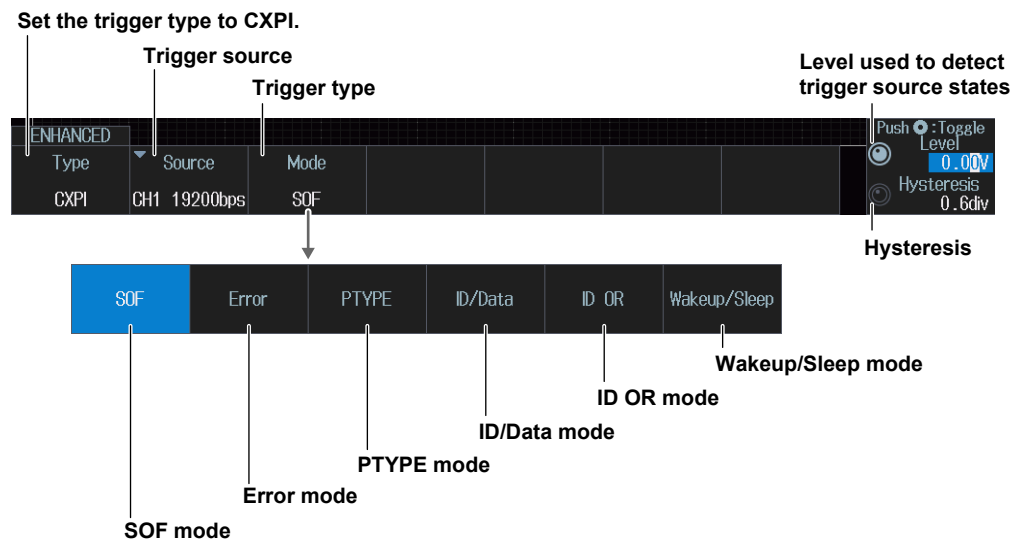

Trigger Source (Source)

Press the **Source** soft key. The following menu items appear.

The screenshot shows the 'Source' menu with the following fields: Type (Source), Mode (CH1), Bit Rate (19200bps), T Sample (0.040Tbit), Clock Tolerance (± 1.0%), HF Rejection (OFF), and T Sample (0.040Tbit). Annotations indicate that 'Bit rate' and 'T Sample' are set with the jog shuttle, and 'Clock tolerance' is also set with the jog shuttle. A reference to 'HF rejection ▶ section 2.3' is present.

When the bit rate is set to User Define

The screenshot shows the 'Source' menu with 'Bit Rate' set to 'User Define'. A sub-menu for 'Bit rate' is shown, with 'Bit rate' set to '19200bps' and 'Clock Tolerance' set to '± 1.0%'. An annotation indicates that 'Bit rate' is set with the jog shuttle.

Trigger Mode (Mode)

SOF (Start of Frame) Mode

Press the **Mode** soft key and then the **SOF** soft key.

The instrument triggers on the start of CXPI bus signal frames.

Error Mode

Press the **Mode** soft key and then the **Error** soft key. The following menu items appear.

The screenshot shows the 'Error' menu with 'Error Type' set to 'Or'. Below it, a sub-menu shows error detection settings: Parity (OFF/ON), CRC (OFF/ON), Data Length (OFF/ON), Framing (OFF/ON), IBS (OFF/ON), and Clock (OFF/ON). An annotation indicates that these settings 'Turns error detection on or off for Parity, CRC, Data Length, Framing, IBS, and Clock errors'. The 'Error Type' is set to 'Or'.

The instrument triggers when it detects any of various types of errors.

PTYPE mode

Press the **Mode** soft key and then the **PTYPE** soft key. The following menu items appear.

Set the trigger mode to PTYPE.

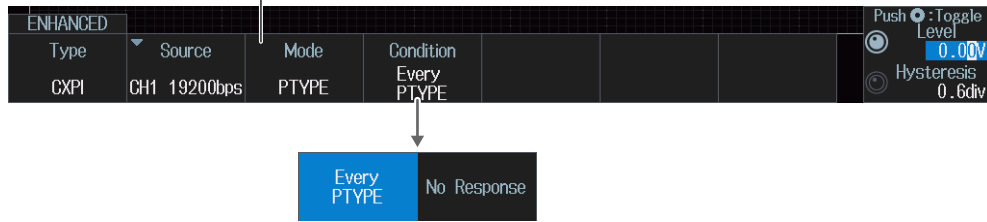

The instrument triggers when it detects the PTYPE of the CXPI bus signal.

ID/Data Mode

Press the **Mode** soft key and then the **ID/Data** soft key. The following menu items appear.

Set the trigger type to ID/Data.
Trigger condition



Trigger Condition (Condition Setup)

Press the **Condition Setup** soft key. The following screen appears.

The instrument triggers on the AND of SOF, ID, frame information, and Data conditions. Items whose check boxes are selected are used as trigger conditions.

When PTYPE is set to No, the ID bit pattern cannot be set to 0.

- **When the Comparison Condition Is True or False**

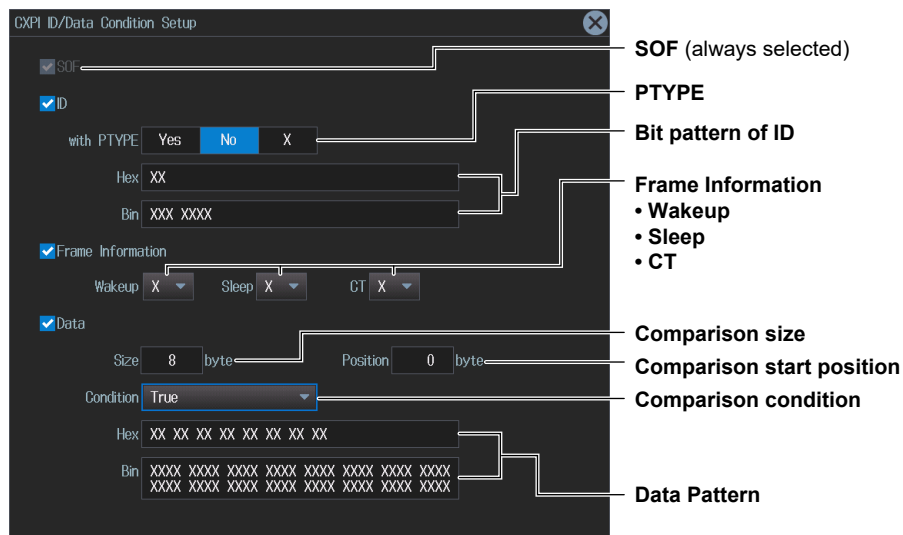

2.17 Triggering on CXPI Bus Signals (Option)

- When the Comparison Condition Is Data = a; Data ≠ a; a ≤ Data; Data ≤ b; a ≤ Data ≤ b; or Data < a, b < Data

The screenshot shows the 'CXPI ID/Data Condition Setup' dialog box. Callouts point to the following elements:

- SOF** (always selected)
- PTYPE**
- Bit pattern of ID**
- Frame Information**
 - Wakeup
 - Sleep
 - CT
- Comparison size**
- Comparison start position**
- Comparison condition**
- Reference Values (a and b)**
- Bit positions of the most significant bit (MSB) and the least significant bit (LSB) in the data to be compared**
- Whether to use a signed (Sign) or unsigned (Unsign) data format**
- Byte order**

ID OR Mode (ID OR)

Press the **Mode** soft key and then the **ID OR** soft key. The following menu items appear.

Set the trigger type to ID OR.

Trigger condition

ENHANCED	Type	Source	Mode	Condition Setup	Push : Toggle Level
	CXPI	CH1 19200bps	ID OR	Condition Setup	0.00V
					Hysteresis 0.6div

Trigger Condition (Condition Setup)

Press the **Condition Setup** soft key. The following screen appears.

The instrument triggers on the AND of the SOF condition and the condition of one of the four IDs. Items whose check boxes are selected are used as trigger conditions.

The screenshot shows the 'CXPI ID OR Condition Setup' dialog box. Callouts point to the following elements:

- SOF** (always selected)
- PTYPE**
- Bit pattern of ID**

Wakeup/Sleep Mode

Press the **Mode** soft key and then the **Wakeup/Sleep** soft key. The following menu items appear. The instrument triggers upon detection of the type you have set.

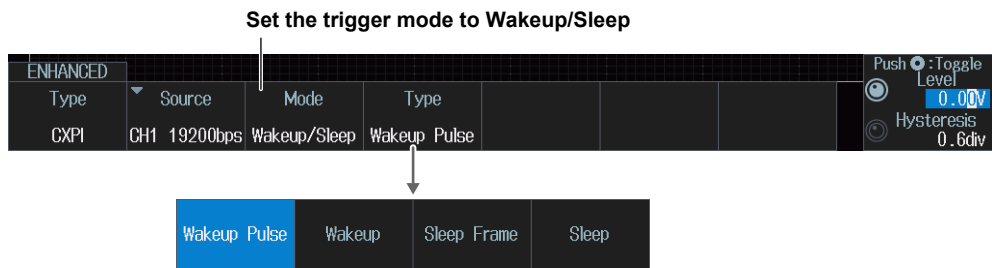

2.18 Triggering on SENT Signals (Option)

This section explains the following settings for triggering on SENT signals:

- Trigger source
 - HF rejection, source bit
- Format
 - Trigger mode
 - Trigger condition
- Level used to detect trigger source states, hysteresis

► “SENT Trigger [ENHANCED, option]” in the Features Guide

Auto Setup

The instrument can automatically set the trigger source format, level, and hysteresis from the received SENT signal and trigger on them. For details, see section 12.6.

ENHANCED SENT Menu

1. Press **ENHANCED**. The ENHANCED menu appears.
You can also tap **MENU** (E) in the upper left of the screen and select the ENHANCED menu from TRIGGER on the top menu that is displayed.
2. Press the **Type** soft key. Select **SENT** from the setup menu that is displayed. The following menu items appear.

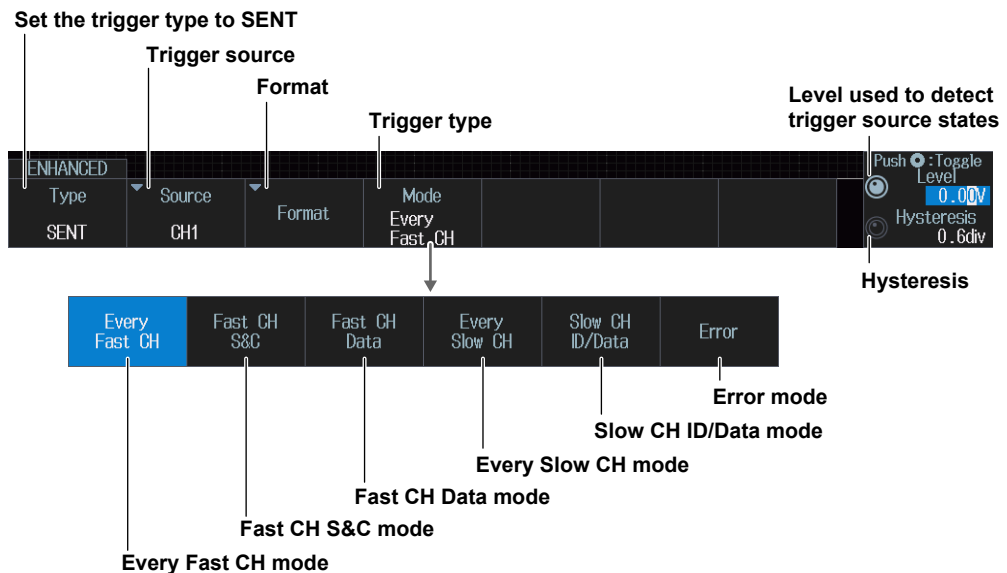

Trigger Source (Source)

Press the **Source** soft key. The menu that appears varies depending on the specified trigger source.

When the Trigger Source Is from CH1 to CH4

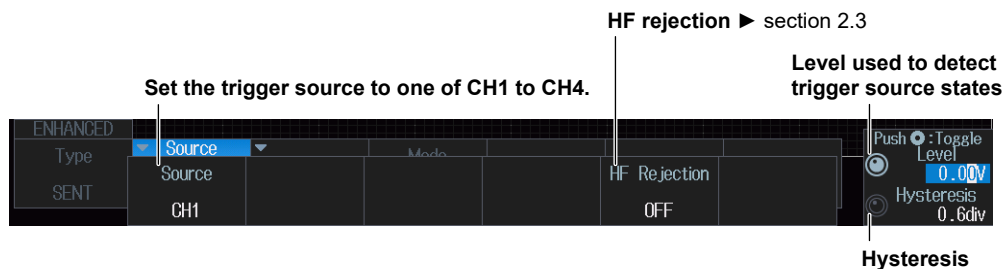

When the Trigger Source Is LOGIC (On models with the logic signal input port)

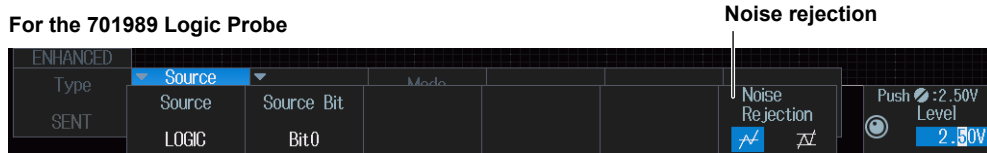
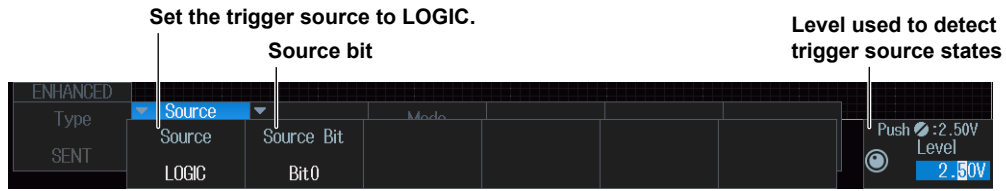

Format (Format)

Press the **Format** soft key. The following menu items appear.

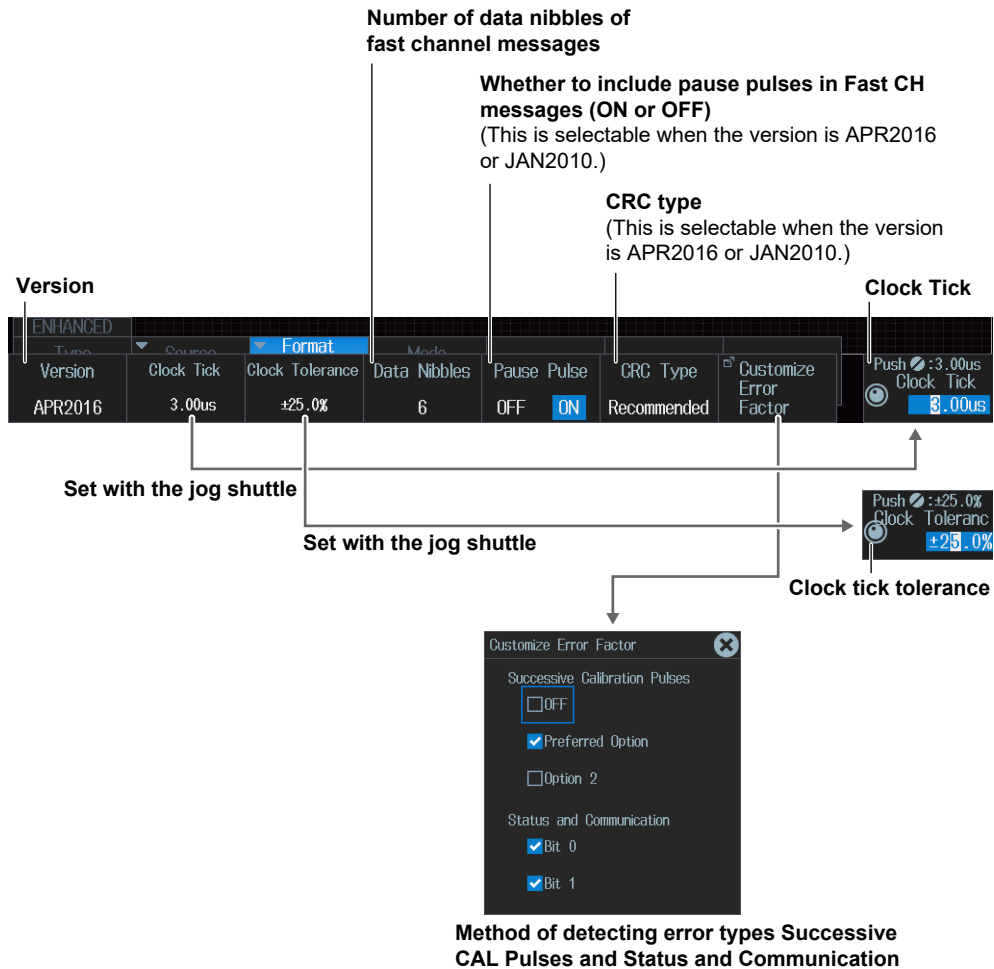

Trigger Mode (Mode)

Every Fast CH Mode

Press the **Mode** soft key and then the **Every Fast CH** soft key.
The instrument triggers when it detects a fast channel message.

2.18 Triggering on SENT Signals (Option)

Fast CH S&C Mode

Press the **Mode** soft key and then the **Fast CH S&C** soft key. The following screen appears. The instrument triggers on the status and communication bit pattern.

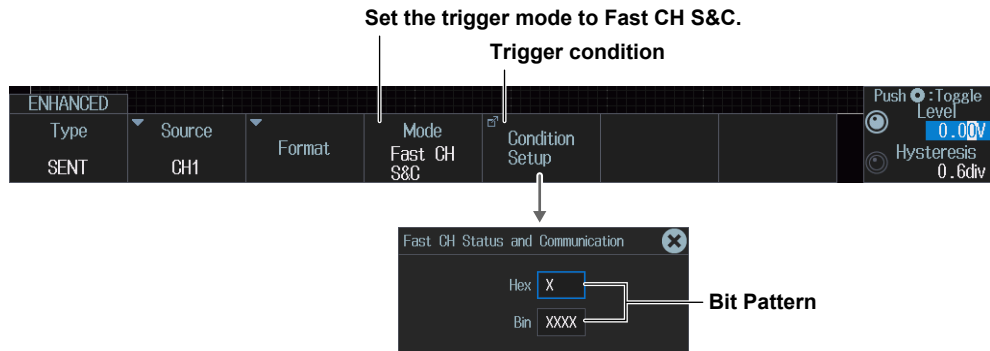

Fast CH Data Mode

Press the **Mode** soft key and then the **Fast CH Data** soft key. The following menu items appear.

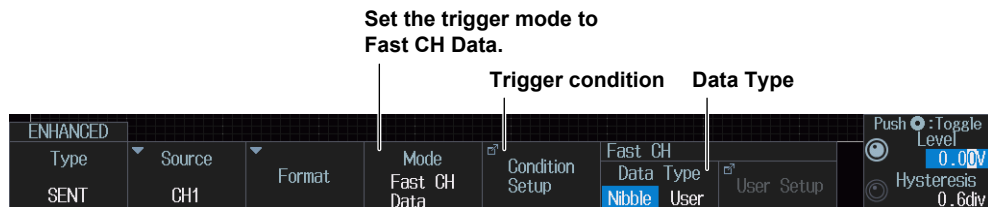

When the data type is User

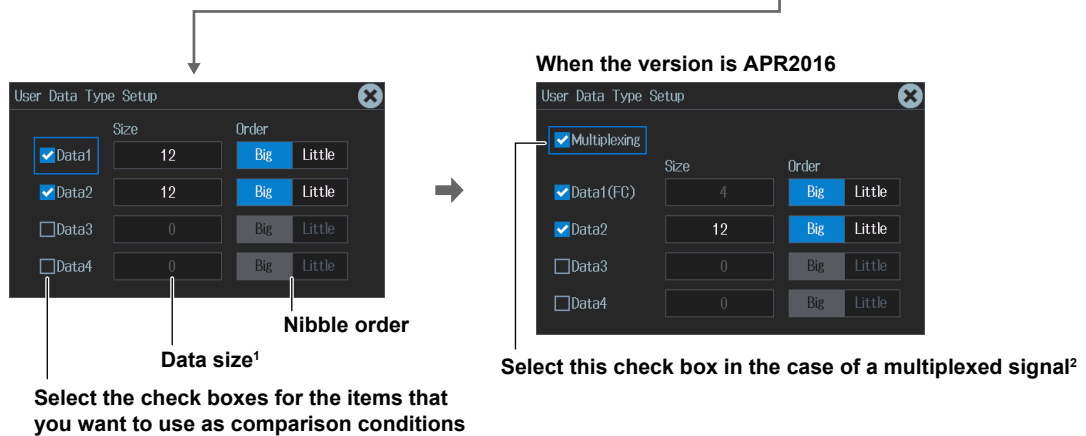
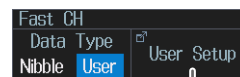

- 1 The total number of bits for Data1 to Data4 is up to 24. If you try to exceed the total number of bits, the data size of other pieces of Data is reduced.
- 2 When the check box for Multiplexing is selected, the Size of Data1 is fixed to 4 to correspond to FC.

Trigger Condition (Condition Setup)

Press the **Condition Setup** soft key. The screen that appears varies depending on the specified fast channel data type.

The instrument triggers on the AND of the fast channel Data conditions. Items whose check boxes are selected are used as trigger conditions.

- **When the Data Type is Nibble**

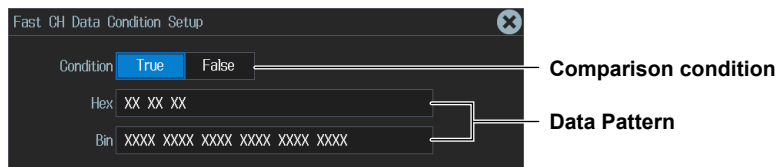

- **When the Data Type Is User**

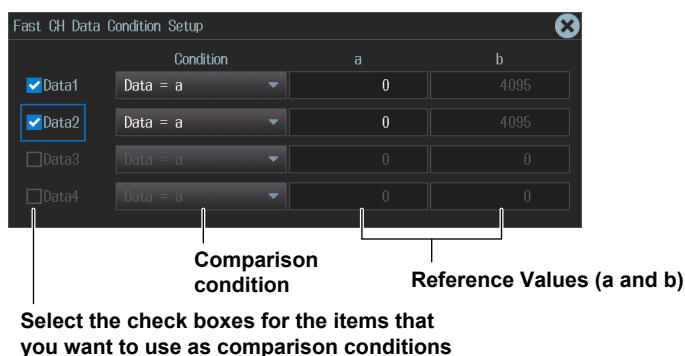

Every Slow CH Mode

Press the **Mode** soft key and then the **Every Slow CH** soft key. The following menu items appear. The instrument triggers when it detects an “Every Slow CH” message.

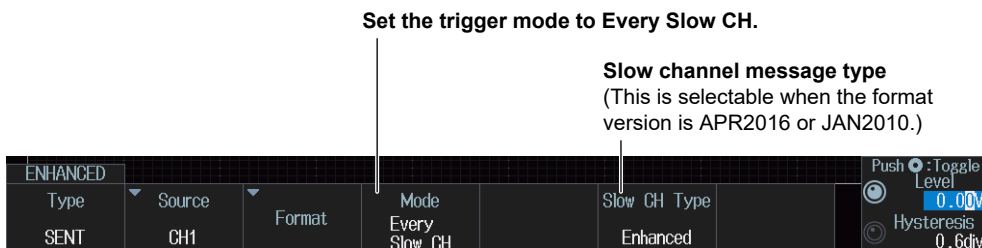

2.18 Triggering on SENT Signals (Option)

Slow CH ID/Data Mode

Press the **Mode** soft key and then the **Slow CH ID/Data** soft key. The following menu items appear.

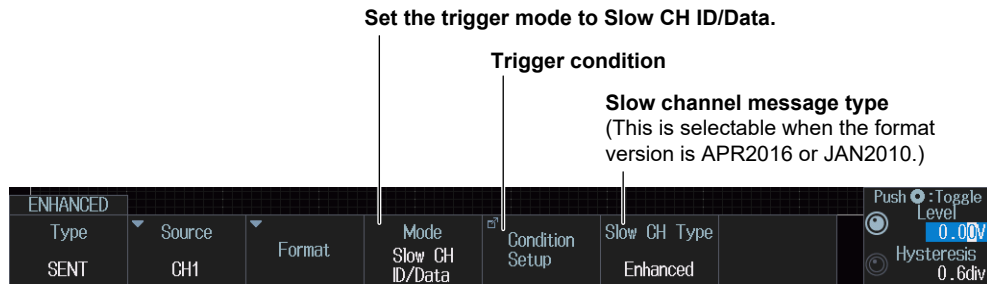

Trigger Condition (Condition Setup)

Press the **Condition Setup** soft key. The screen that appears varies depending on the specified slow channel message type.

The instrument triggers on the AND of the slow channel ID and Data conditions. Items whose check boxes are selected are used as trigger conditions. Set ID and data reference values a and b in Hex (hexadecimal) or Dec (decimal) according to the input format setting.

- **When the Message Type is Short**

When the data comparison condition is Data = a; Data ≠ a; a ≤ Data; Data ≤ b; a ≤ Data ≤ b; or Data < a, b < Data

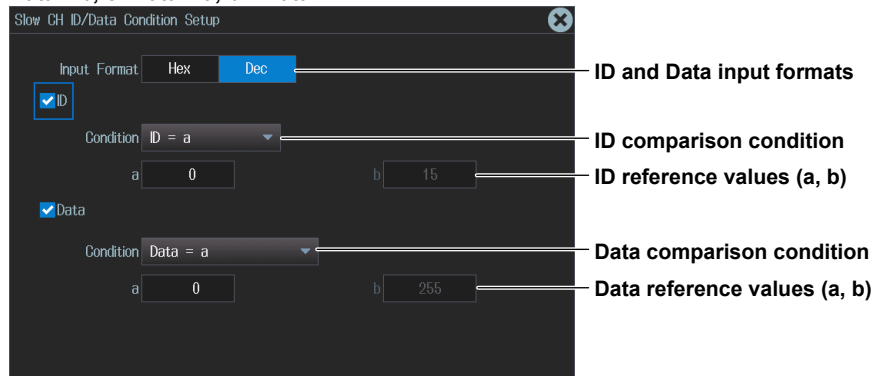

When the data comparison condition is True or False



Setting ID/Data Reference Values a and b

Input format setting		Hex	Dec
Selectable range for reference values a and b	ID	0 to F	0 to 15
	Data	00 to FF	0 to 255

- When the Message Type Is Enhanced

When the ID and Data Message Formats Are Set to “12bit data, 8bit ID”

When the data comparison condition is Data = a; Data ≠ a; a ≤ Data; Data ≤ b; a ≤ Data ≤ b; or Data < a, b < Data

Set the ID and data message formats to 12bit data and 8bit ID.

ID and Data input formats

ID comparison condition

ID reference values (a, b)

Data comparison condition

Data reference values (a, b)

When the data comparison condition is True or False

ID input format

Data comparison condition

Data Pattern

Setting ID/Data Reference Values a and b

Input format setting		Hex	Dec
Selectable range for reference values a and b	ID	00 to FF	0 to 255
	Data	000 to FFF	0 to 4095

2.18 Triggering on SENT Signals (Option)

When the ID and Data Message Formats Are Set to “16bit data, 4bit ID”

When the data comparison condition is Data = a; Data ≠ a; a ≤ Data; Data ≤ b; a ≤ Data ≤ b; or Data < a, b < Data

Slow CH ID/Data Condition Setup

Configuration bit: 12bit data, 8bit ID | **16bit data, 4bit ID**

Input Format: Hex | **Dec**

ID
Condition: ID = a
a: 0 | b: 15

Data
Condition: Data = a
a: 0 | b: 65535

Set the ID and data message formats to 16bit data and 4bit ID.

ID and Data input formats

ID comparison condition

ID reference values (a, b)

Data comparison condition

Data reference values (a, b)

When the data comparison condition is True or False

ID
Condition: ID = a
a: 0 | b: 15

Data
Condition: True

Hex: XX XX

Bin: XXXX XXXX XXXX XXXX

ID input format

Data comparison condition

Data Pattern

Setting ID/Data Reference Values a and b

Input format setting		Hex	Dec
Selectable range for reference values a and b	ID	0 to F	0 to 15
	Data	0000 to FFFF	0 to 65535

Error Mode

Press the **Mode** soft key and then the **Error** soft key. The following menu items appear.

Set the trigger mode to Error.

Slow channel message type
(This is selectable when the format version is APR2016 or JAN2010.)

ENHANCED	Type	Source	Format	Mode	Error Type	Slow CH Type	Push : Toggle Level
	SENT	CH1		Error	Or	Enhanced	0.00V Hysteresis 0.6div

Successive CAL Pulses	Nibble Number	Nibble Data Value	Fast CH CRC	Status and Communication	Slow CH CRC
OFF ON	OFF ON	OFF ON	OFF ON	OFF ON	OFF ON

Turns on or off the detection of Successive CAL Pulses¹, Nibble Number, Nibble Data Value, Fast CH CRC, Status and Communication², and Slow CH CRC errors

- 1 Not selectable when Successive Calibration Pulses is set to OFF for Customize Error Factor in “Setting the Format (Format)” (page 2-47)
- 2 Selectable when the Bit 0 or Bit 1 check box is selected under Status and Communication for Customize Error Factor in “Setting the Format (Format)” (page 2-47)

The instrument triggers when it detects any of various types of errors.

2.19 Triggering on PSI5 Airbag Signals (Option)

This section explains the following settings for triggering on PSI5 Airbag signals:

- Trigger source (sync signal, data frame source)
 - Bit rate, data length, error detection method, clock tolerance, HF rejection, sync signal noise rejection
- Time range of each slot
 - Start position of each slot and the end position of the last slot
- Level and hysteresis for detecting trigger source states
- Trigger type
 - Trigger conditions

► “PSI5 Airbag Trigger [ENHANCED, option]” in the Features Guide

Auto Setup

The instrument can automatically set the bit rate, data length, error detection method, level, and hysteresis of the trigger source from the received PSI5 Airbag signal and trigger on them. For details, see section 12.7.

ENHANCED_PSI5 Airbag Menu

1. Press **ENHANCED**. The ENHANCED menu appears.
You can also tap **MENU** (ⓘ) in the upper left of the screen and select the ENHANCED menu from TRIGGER on the top menu that is displayed.
2. Press the **Type** soft key. Select **PSI5 Airbag** from the setup menu that is displayed. The following menu items appear.

Set the trigger type to PSI5 Airbag.

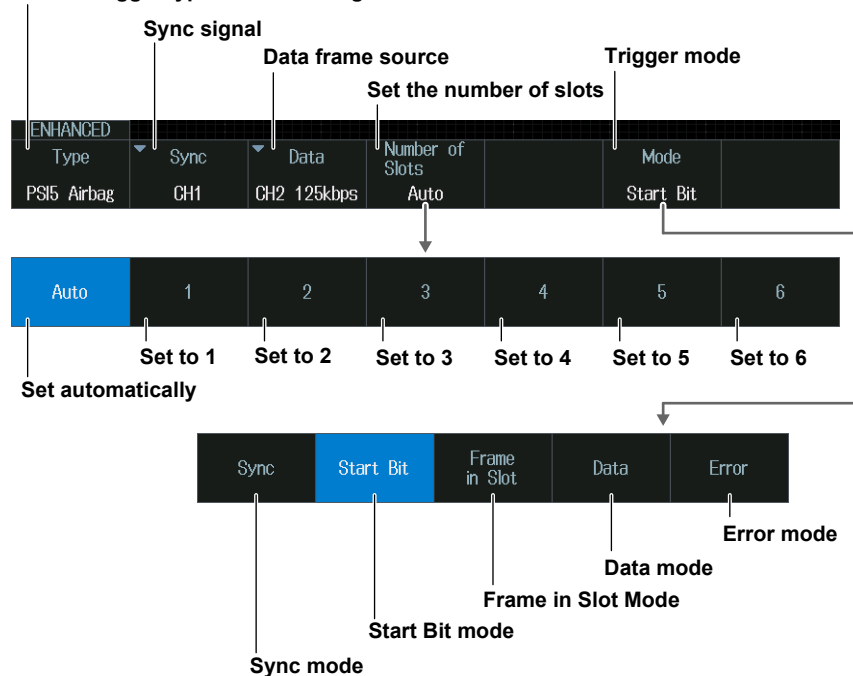

When the number of slots is set between 1 and 6

Set the time range of each slot.

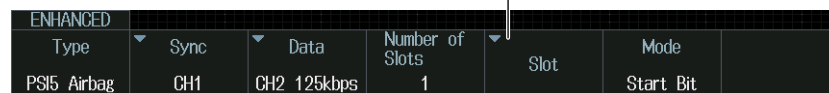

Sync Signal (Sync)

Press the **Sync** soft key. The following menu appears.

Set the sync signal to a channel from CH1 to CH4 or None.

HF rejection ▶ section 2.3
Not displayed when the sync signal is set to None

Level for detecting sync signal states

Hysteresis

Data Frame Source (Data)

Press the **Data** soft key to display the following menu.

Set the data frame source.

Bit rate

Data length

Error detection method

HF rejection ▶ section 2.3

Level for detecting data frame source states

Hysteresis

Sync signal noise rejection
These values can be controlled when the setting is on.

Clock tolerance

When the bit rate is set to User Define

Bit rate

Setting the Time Range of Each Slot (Slot)

Press the **Slot** soft key to display the following menu.

Example when the number of slots is set to 6

Select the slot for setting the start position.

Select the last slot for setting the end position.

ENHANCED	Type	Sync	Data	Number of Slots	Slot	Mode	Slot No.
	PSI5 Airbag	CH1	CH2 125kbps	6	Slot	Frame in Slot	1
	Slot 1 Start	Slot 2 Start	Slot 3 Start	Slot 4 Start	Slot 5 Start	Slot 6 Start	Slot 6 End
	44.0us	181.3us	328.9us	492.0us	672.1us	870.0us	1088.3us

Set the start position of each slot and the end position of the last slot.

Note

- The slot start position that can be set varies depending on the number of slots (Number of Slots), which specifies the trigger source frame pattern.
- The slot end position that can be set is the largest number specified by Number of Slots.

Trigger Mode (Mode)

Sync Mode

Press the **Mode** soft key and then the **Sync** soft key.

The instrument triggers on the rising edge of sync pulses.

Start Bit Mode

Press the **Mode** soft key and then the **Start Bit** soft key.

The instrument triggers on start bits.

Frame in Slot Mode

Press the **Mode** soft key and then the **Frame in Slot** soft key to display the following menu.

The instrument triggers on data frames included in the selected slot. Frame in Slot mode will not be available if the sync signal (Sync) is set to None.

Set the trigger mode to Frame in Slot.

ENHANCED	Type	Sync	Data	Number of Slots	Slot	Mode	Slot No.
	PSI5 Airbag	CH1	CH2 125kbps	6	Slot	Frame in Slot	1

Slot No.

1	2	3	4	5	6
---	---	---	---	---	---

Set the slot number for specifying the trigger source frame pattern.

- 1 to N (the number of slots) when the number of slots on the Setup menu is set to a number from 1 to 6
- 1 to 6 when the number of slots on the Setup menu is set to Auto

2.19 Triggering on PSI5 Airbag Signals (Option)

Data Mode

Press the **Mode** soft key and then the **Data** soft key to display the following menu.

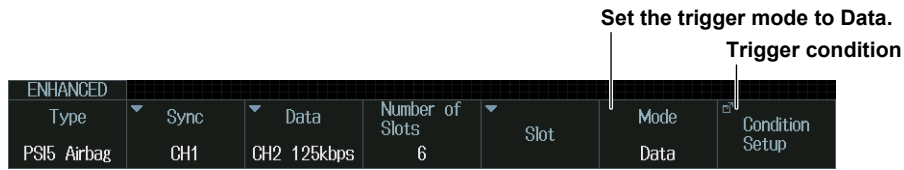

Trigger Condition (Condition Setup)

Press the **Condition Setup** soft key. The following screen appears.
The instrument triggers on data frames included in the selected slot.

- **When the Comparison Condition Is True or False**

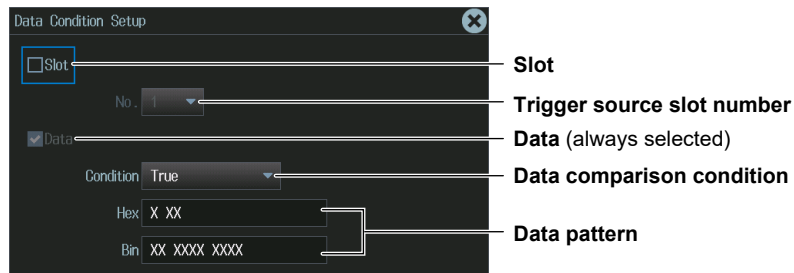

- **When the Comparison Condition Is Data = a; Data ≠ a; a ≤ Data; Data ≤ b; a ≤ Data ≤ b; or Data < a, b < Data**

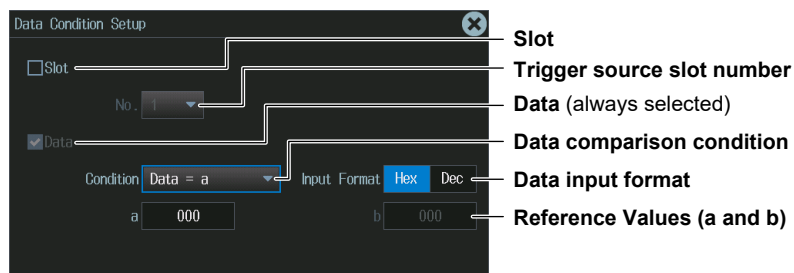

Error Mode

Press the **Mode** soft key and then the **Error** soft key to display the following menu.
The instrument triggers when it detects various types of errors.

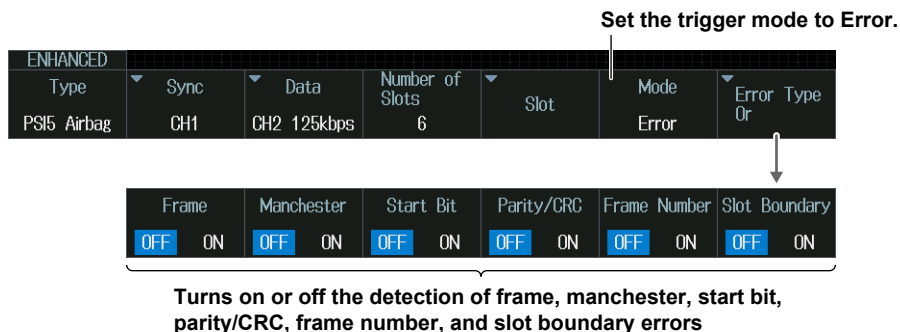

2.20 Triggering on UART Signals (Option)

This section explains the following settings for triggering on UART signals:

- Trigger source
 - Bit rate, bit order, polarity, HF rejection, source bit, sample point
- Format
- Trigger mode
 - Trigger condition
- Level used to detect trigger source states, hysteresis

▶ [“UART Trigger \[ENHANCED, option\]” in the Features Guide](#)

Auto Setup

The instrument can automatically set the trigger source level and bit rate from the received UART signal and trigger on them. For details, see section 12.8.

ENHANCED UART Menu

1. Press **ENHANCED**. The ENHANCED menu appears.
You can also tap **MENU** (☰) in the upper left of the screen and select the ENHANCED menu from TRIGGER on the top menu that is displayed.
2. Press the **Type** soft key. Select **UART** from the setup menu that is displayed. The following menu items appear.

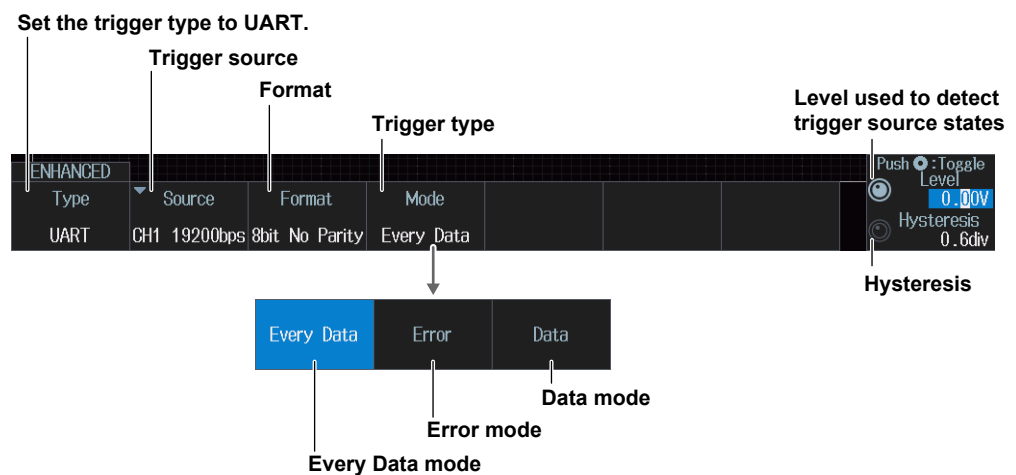

Trigger Source (Source)

Press the **Source** soft key. The menu that appears varies depending on the specified trigger source.

When the Trigger Source Is from CH1 to CH4

Set the trigger source to one of CH1 to CH4.

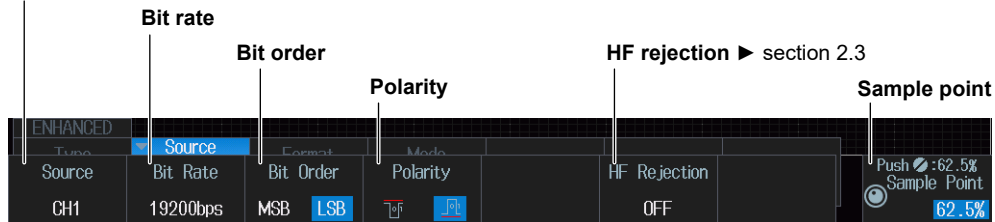

When the bit rate is set to User Define

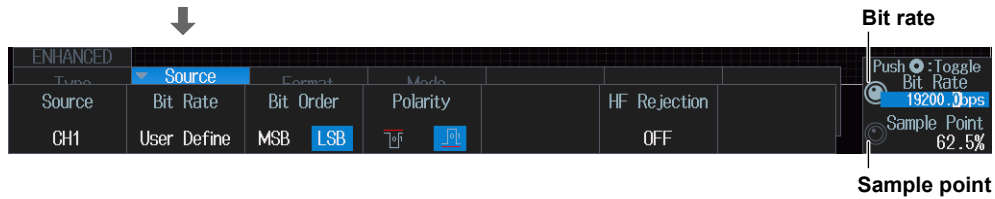

When the Trigger Source Is LOGIC (On models with the logic signal input port)

Set the trigger source to LOGIC.

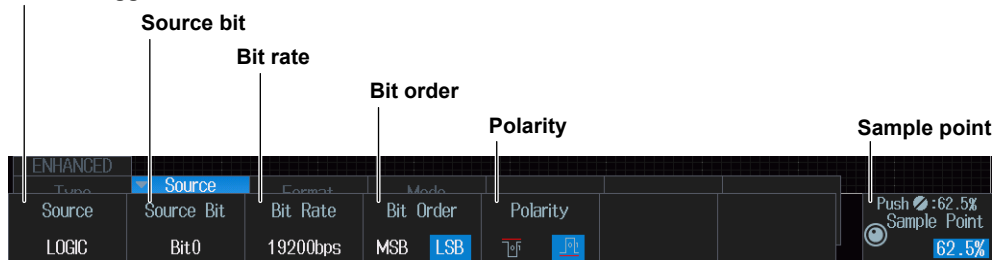

When the bit rate is set to User Define

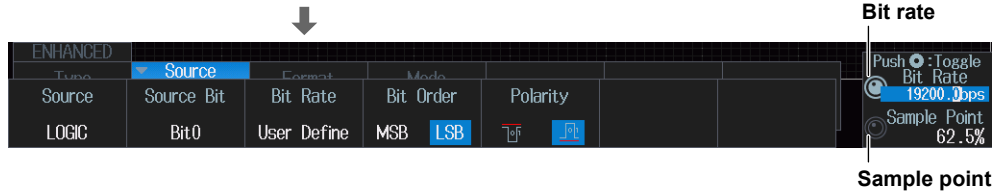

For the 701989 Logic Probe



When the bit rate is set to User Define

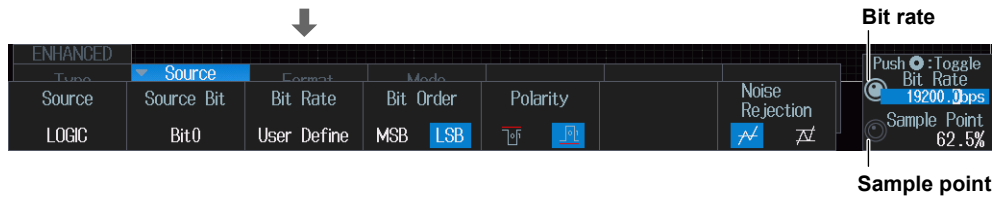

Trigger Mode (Mode)

Every Data Mode

Press the **Mode** soft key and then the **Every Data** soft key. The instrument triggers on all data.

Error Mode

Press the **Mode** soft key and then the **Error** soft key. The following menu items appear.

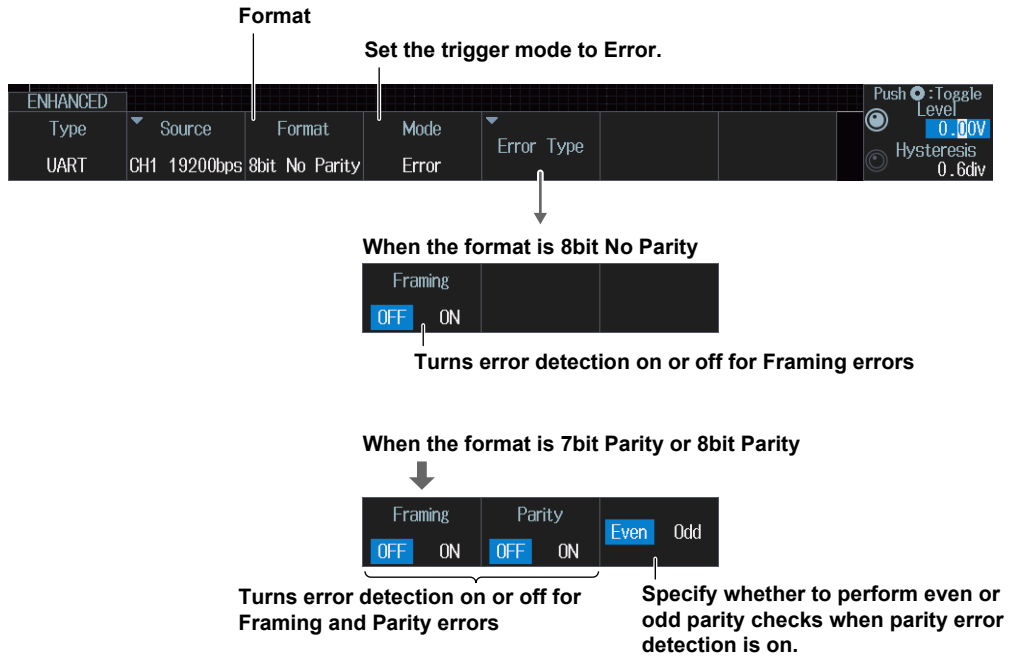

The instrument triggers when it detects an error.

Data Mode

Press the **Mode** soft key and then the **Data** soft key. The following menu items appear.

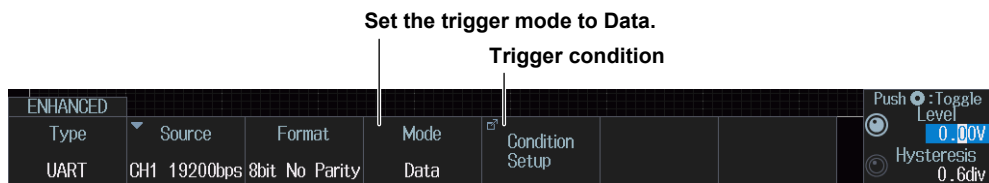

Trigger Condition (Condition Setup)

Press the **Condition Setup** soft key. The following screen appears. The instrument triggers when the data pattern is matched.

- When the Data Pattern Input Format is Pattern

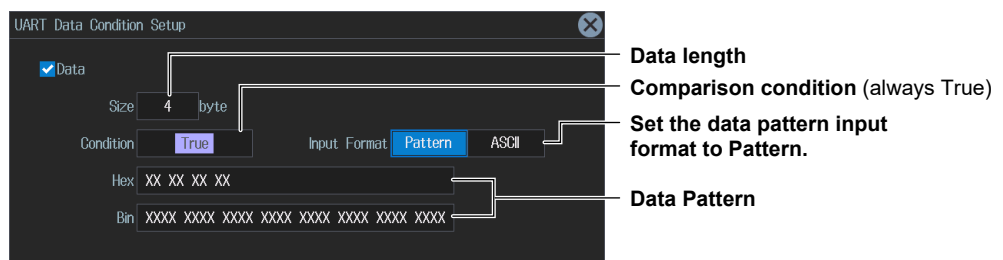

2.20 Triggering on UART Signals (Option)

- When the Data Pattern Input Format is ASCII

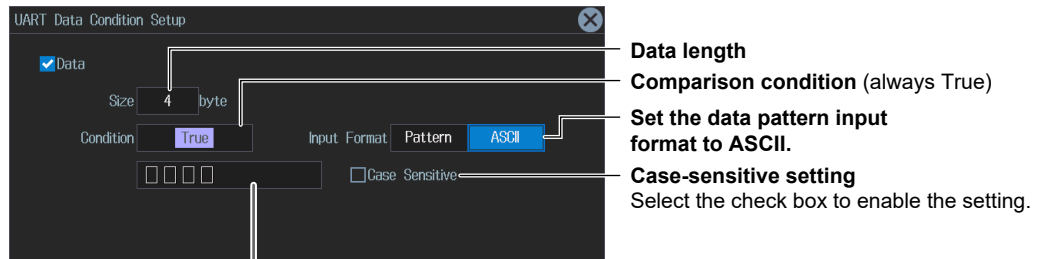

Data Pattern
Use the keyboard that appears on the screen.

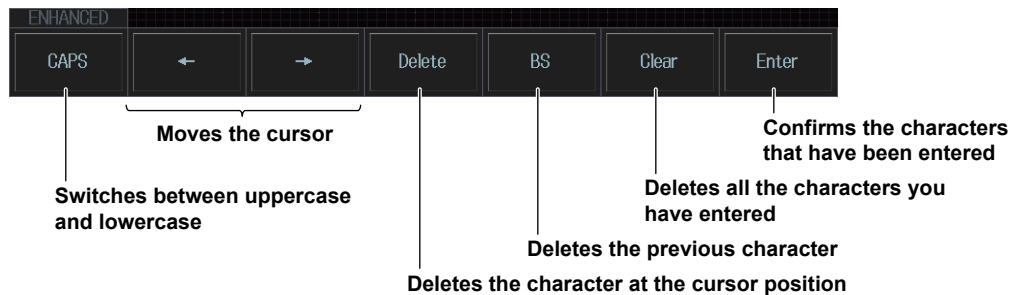
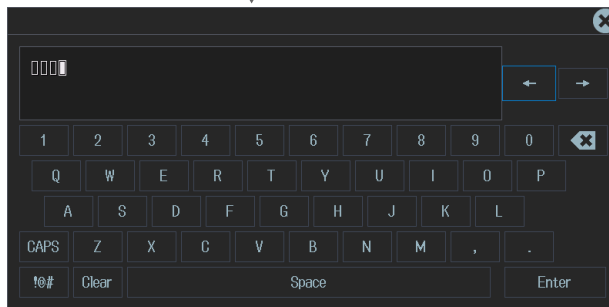

Data Pattern

You can enter up to 4 characters.

- You can switch between uppercase and lowercase to enter alphabet characters. However, case is distinguished only when the **Case Sensitive** check box is selected.
- The special characters CR, LF, SP, and NUL are shown in single quotation marks. These special characters are counted as one character including the single quotation marks.
Example: **AB'CR'D** (4 characters), **XY'SP'** (3 characters), **P'NUL'WU** (4 characters)
- The entered string, including the character codes for the case, is retained even if the input format is changed to Bin or Hex. It is also retained when the format is changed from Bin or Hex to ASCII.
- If a character code that does not exist on the keyboard is entered when the input format is Bin or Hex and then the input format is changed to ASCII, a white square is displayed in the corresponding position.

2.21 Triggering on I²C Bus Signals (Option)

This section explains the following settings for triggering on I²C bus signals.

- SCL source and SDA source
 - HF rejection, source bit, level used to detect the SCL source/SDA source states, and hysteresis
- Trigger mode
 - Trigger condition

► “I²C Bus Trigger [ENHANCED, option]” in the Features Guide

Auto Setup

The instrument can automatically set the source level from the received I²C bus signal and trigger on it. For details, see section 12.9.

ENHANCED I2C Menu

1. Press **ENHANCED**. The ENHANCED menu appears.
You can also tap **MENU** (Ⓜ) in the upper left of the screen and select the ENHANCED menu from TRIGGER on the top menu that is displayed.
2. Press the **Type** soft key. Select **I2C** from the setup menu that is displayed. The following menu items appear.

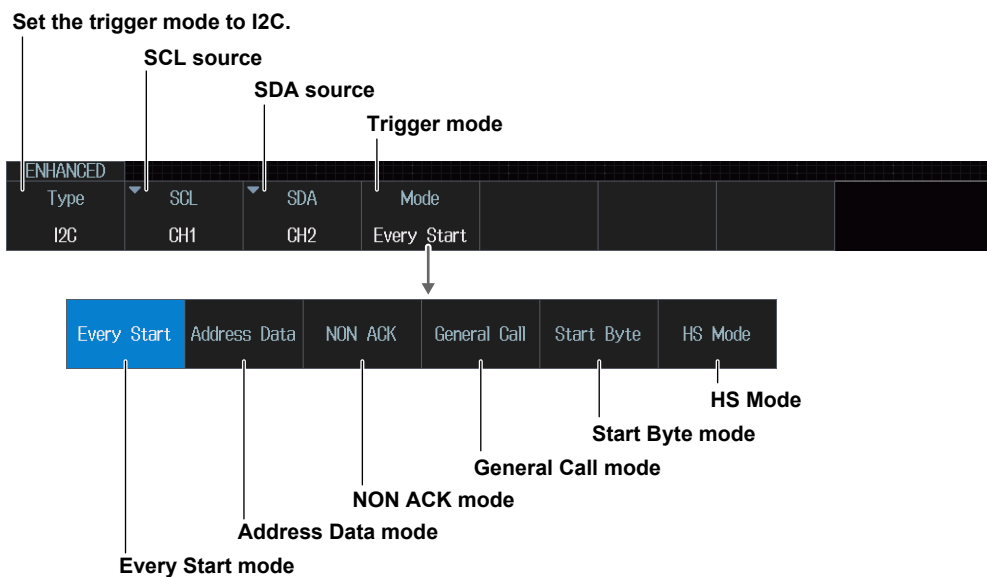

SCL Source (SCL), SDA Source (SDA)

Press the **SCL** or **SDA** soft key. The menu that appears varies depending on the specified source. This section explains how to set the SCL source. The SCL source is set in the same way as the SDA source.

When the SCL Source Is a Channel from CH1 to CH4

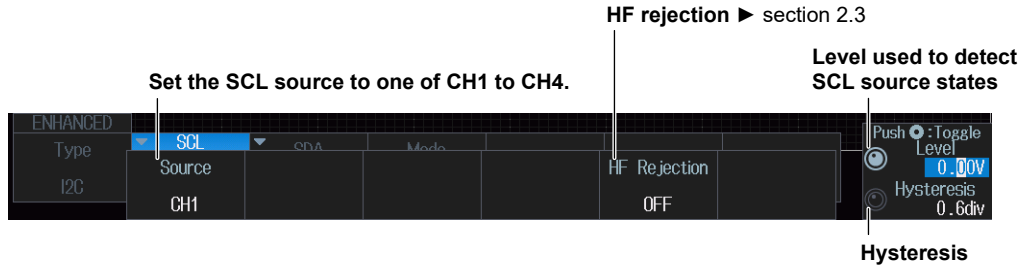

When the SCL Source Is LOGIC (On models with the logic signal input port)

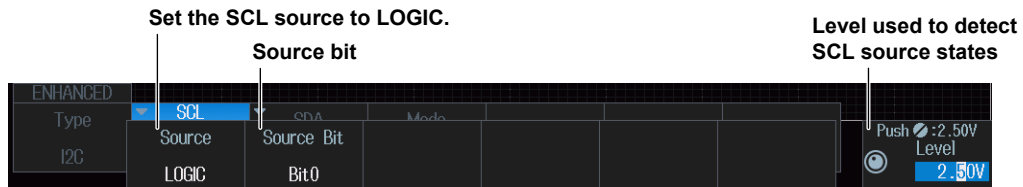

Trigger Mode (Mode) Every Start Mode

Press the **Mode** soft key and then the **Every Start** soft key. The instrument triggers when it detects a start condition.

Address Data Mode

Press the **Mode** soft key and then the **Address Data** soft key. The following menu items appear.

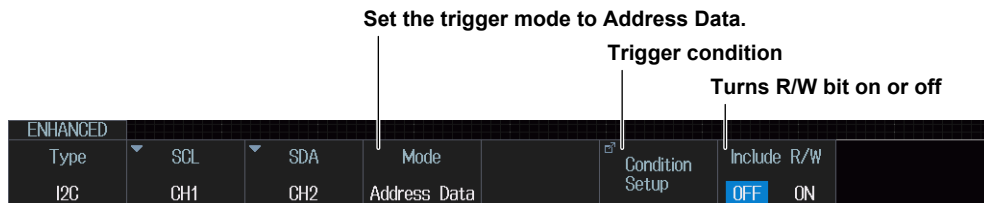

R/W Bit Inclusion (Include R/W)

Specify whether to include the R/W bit (ON) or omit it (OFF) when setting the address pattern.

Note

R/W bit inclusion (Include R/W) can also be set by using Analyzing and Searching I2C Bus Signals and then Bus Setup (Setup). The settings are synced. For details about I2C bus signal Analysis, see section 12.9.

Trigger Condition (Condition Setup)

Press the **Condition Setup** soft key. The following screen appears.

The instrument triggers on the AND of the start, address pattern, data pattern, and comparison start position conditions. Items whose check boxes are selected are used as trigger conditions.

- **When Address Type Is 7bit Address**

When the R/W bit is not included (OFF)

The screenshot shows the 'I2C Address & Data Condition Setup' dialog. The 'Start' checkbox is checked. The 'Address' checkbox is checked, and the 'Type' is set to '7bit Address'. The 'Direction' is set to 'X'. The 'Hex' field contains 'XX' and the 'Bin' field contains 'XXX XXXX'. The 'Data' checkbox is checked, 'Size' is '1', 'Position' is checked and set to '0 byte', and the 'Condition' is set to 'True'. The 'Hex' field contains 'XX' and the 'Bin' field contains 'XXXX XXXX'. Annotations on the right point to: Start (always selected), Set the address type to 7bit Address., R/W bit, Address pattern, Data length, Comparison start position, Comparison condition, and Data Pattern.

When the R/W bit is included (ON)

This screenshot shows the same dialog as above, but the 'Direction' dropdown is grayed out and set to 'X'. Annotations on the right point to: R/W bit (grayed out) and Address pattern (Set this including R/W bit.).

- **When Address Type Is 7bit + Sub Address**

When the R/W bit is not included (OFF)

The screenshot shows the 'I2C Address & Data Condition Setup' dialog. The 'Start' checkbox is checked. The 'Address' checkbox is checked, and the 'Type' is set to '7bit + Sub Address'. The 'Direction' is set to 'X'. The 'Hex' field contains 'XX XX' and the 'Bin' field contains 'XXX XXXX XXXX XXXX'. The 'Data' checkbox is checked, 'Size' is '1', 'Position' is checked and set to '0 byte', and the 'Condition' is set to 'True'. The 'Hex' field contains 'XX' and the 'Bin' field contains 'XXXX XXXX'. Annotations on the right point to: Start (always selected), Set the address type to 7bit + Sub Address., R/W bit, Address pattern, Data length, Comparison start position, Comparison condition, and Data Pattern.

When the R/W bit is included (ON)

This screenshot shows the same dialog as above, but the 'Direction' dropdown is grayed out and set to 'X'. Annotations on the right point to: R/W bit (grayed out) and Address pattern (Set this including R/W bit.).

2.21 Triggering on I2C Bus Signals (Option)

- **When Address Type Is 10bit Address**

When the R/W bit is not included (OFF)

Annotations for the 'When the R/W bit is not included (OFF)' configuration:

- Start** (always selected)
- Set the address type to 10bit Address.**
- R/W bit**
- Address pattern**
- Data length**
- Comparison start position**
- Comparison condition**
- Data Pattern**

When the R/W bit is included (ON)

Annotations for the 'When the R/W bit is included (ON)' configuration:

- R/W bit (grayed out)**
- Address pattern (Set this including R/W bit.)**

NON ACK Mode

Press the **Mode** soft key and then the **NON ACK** soft key. The following menu items appear.

Set the trigger mode to **NON ACK**.

ENHANCED		Type	SCL	SDA	Mode	Ignore	Start Byte	HS Mode	Read Access
		I2C	CH1	CH2	NON ACK	OFF	ON	OFF	ON

Select whether to use the acknowledge bits as trigger sources.

- Start byte
- HS mode master code
- Read access byte

The instrument triggers when the acknowledgment bit is Nack.

General Call Mode

Press the **Mode** soft key and then the **General Call** soft key. The following menu items appear.

Set the trigger mode to **General Call**.

ENHANCED		Type	SCL	SDA	Mode	Condition Setup
		I2C	CH1	CH2	General Call	Condition Setup

Trigger Condition (Condition Setup)

Press the **Condition Setup** soft key. The following screen appears.

When Second Byte is set to Master Address, the instrument triggers on the AND of the general call address (0000 0000), second byte address pattern, data pattern, and comparison start position conditions. When other than Master Address is set, the instrument triggers on the AND of the general call address (0000 0000) and the second byte address pattern conditions. Items whose check boxes are selected are used as trigger conditions.

- When Address Type is “0000 0100” “0000 0110”

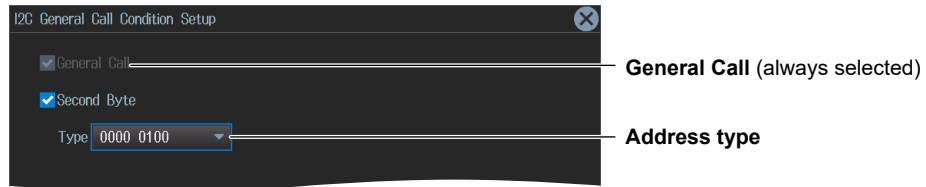

- When Address Type Is Master Address

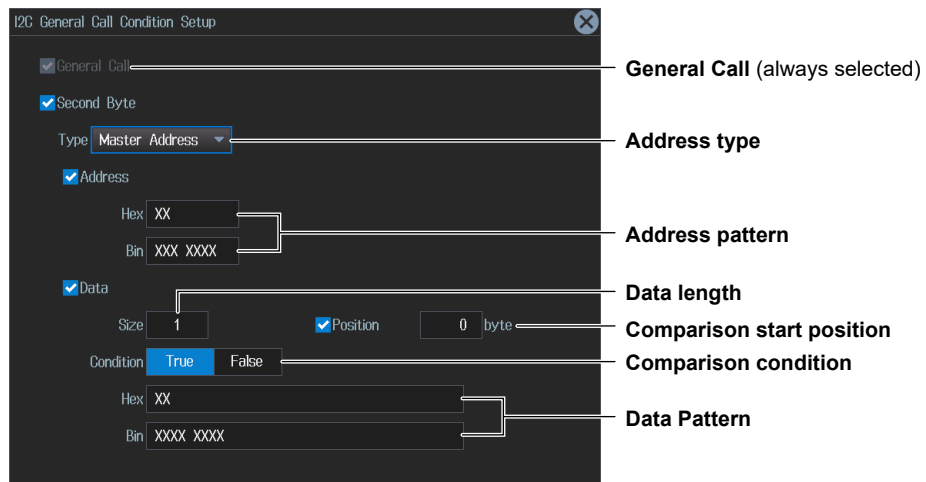

Start Byte Mode

Press the **Mode** soft key and then the **Start Byte** soft key.

The instrument triggers when it detects the start byte master code.

HS Mode

Press the **Mode** soft key and then the **HS Mode** soft key.

The instrument triggers when it detects the high speed mode master code.

2.22 Triggering on SPI Bus Signals (Option)

This section explains the following settings for triggering on SPI bus signals:

- Wiring system (Mode)
 - Clock source
 - Polarity, HF rejection, source bit, level used to detect clock source edges, and hysteresis
- Data source
 - HF rejection, source bit, level used to detect data source states, and hysteresis
- Chip select source
 - Active state, source bit, level used to detect chip select source states, and hysteresis
- Trigger condition

► [“SPI Bus Trigger \[ENHANCED, option\]” in the Features Guide](#)

Auto Setup

The instrument can automatically set the source level from the received SPI bus signal and trigger on it. For details, see section 12.10.

ENHANCED SPI Menu

1. Press **ENHANCED**. The ENHANCED menu appears.
You can also tap **MENU** () in the upper left of the screen and select the ENHANCED menu from TRIGGER on the top menu that is displayed.
2. Press the **Type** soft key. Select **SPI** from the setup menu that is displayed. The following menu items appear.

When Wiring System Is 3 Wire

Set the trigger type to SPI.

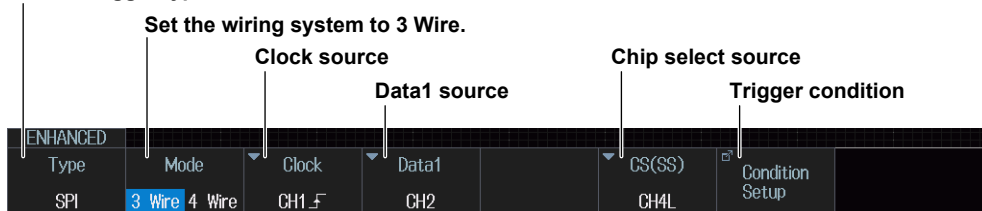

When Wiring System Is 4 Wire

Set the trigger type to SPI.

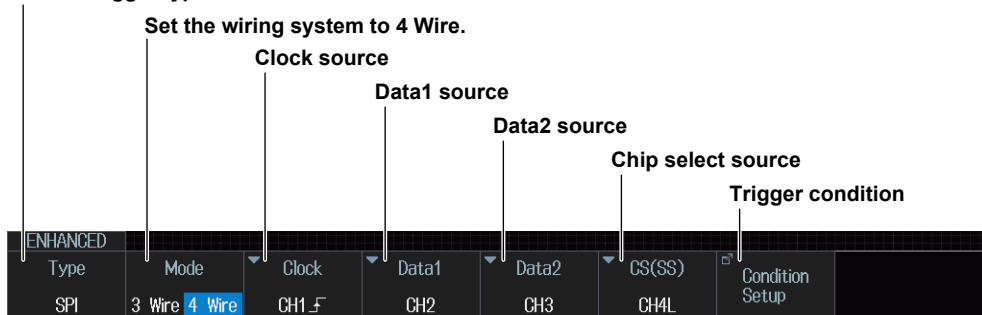

Clock Source (Clock)

Press the **Clock** soft key. The menu that appears varies depending on the specified clock source.

When the Clock Source Is from CH1 to CH4

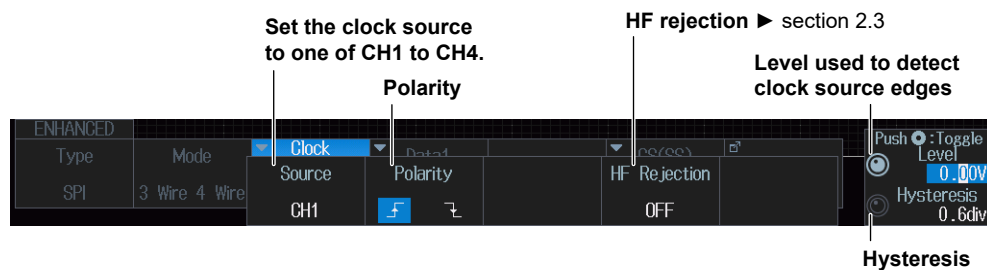

When the Clock Source Is LOGIC (On models with the logic signal input port)

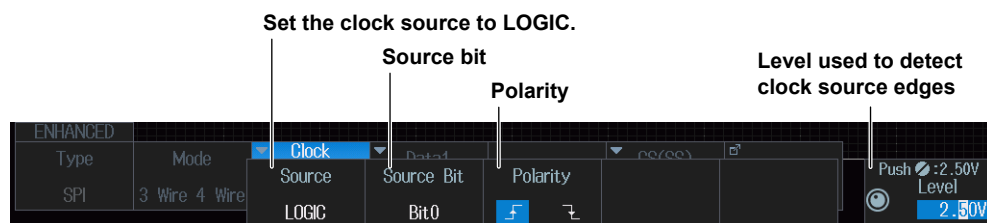

For the 701989 Logic Probe

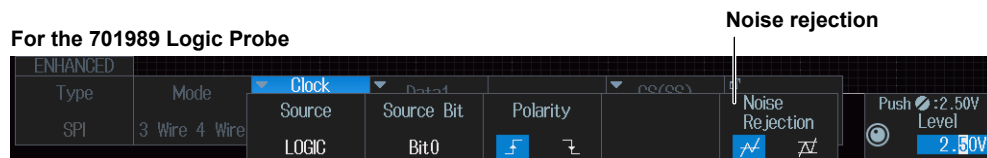

2.22 Triggering on SPI Bus Signals (Option)

Data1 Source (Data1), Data 2 Source (Data2)

Press the **Data1** or **Data2** soft key. The menu that appears varies depending on the specified data source. This section explains how to set the Data 1 source. The Data 2 source can be set in the same way. Set the Data2 source when the wiring system is 4 Wire.

When the Data1 Source Is from CH1 to CH4

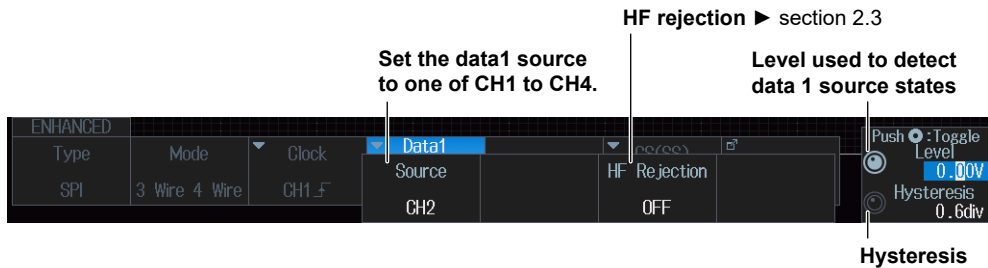

When the Data1 Source Is LOGIC (On models with the logic signal input port)

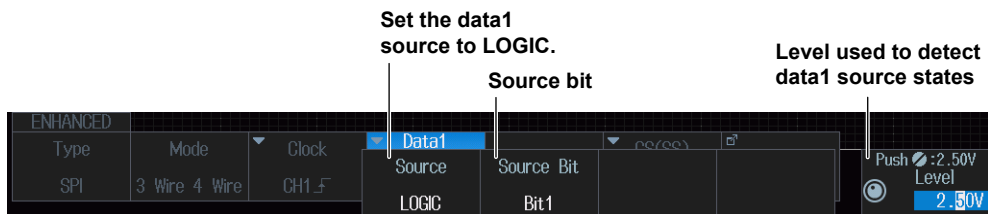

For the 701989 Logic Probe



Chip Select Source (CS (SS))

Press the **CS(SS)** soft key. The menu that appears varies depending on the specified data source.

When the Chip Select Source Is from CH1 to CH4

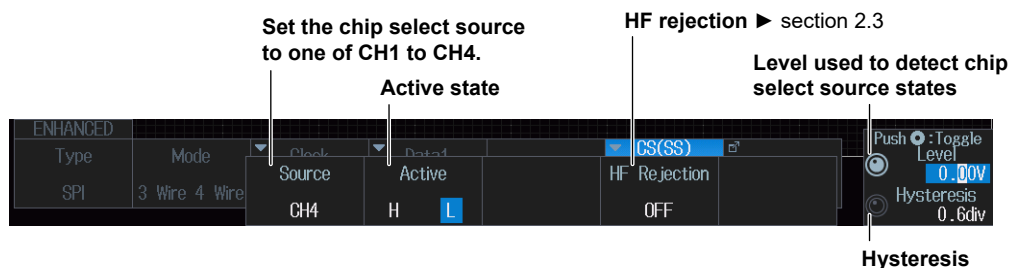

When the Chip Select Source Is LOGIC (On models with the logic signal input port)

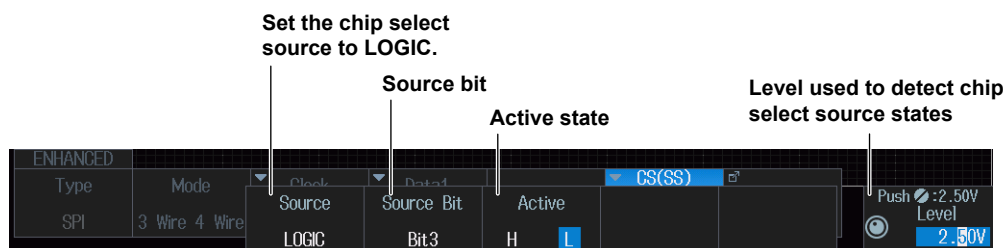

For the 701989 Logic Probe



Trigger Condition (Condition Setup)

Press the **Condition Setup** soft key. The following screen appears.

When Wiring System Is 4 Wire

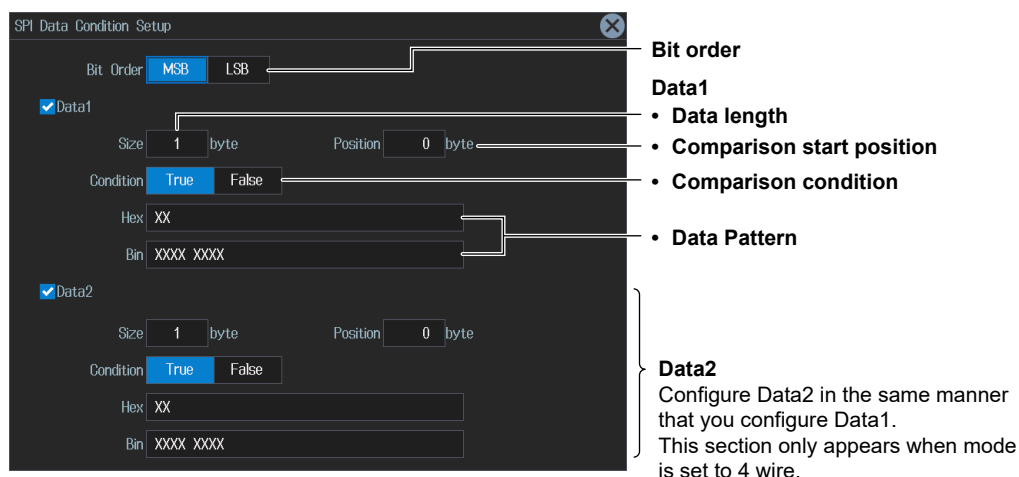

When Wiring System Is 3 Wire

Only set the trigger condition for Data1.

2.23 Triggering On User-Defined Serial Bus Signals

This section explains the following settings for triggering on user-defined serial bus signals:

- Bit rate
- Data source
 - Data source state, HF rejection, level used to detect data source states, and hysteresis
- Turning the clock on or off
 - Clock source, enable source, latch source
- Trigger condition

▶ “User-Defined Serial Bus Trigger [User Define, ENHANCED]” in the Features Guide

ENHANCED User Define Menu

1. Press **ENHANCED**. The ENHANCED menu appears.
You can also tap **MENU** (☰) in the upper left of the screen and select the ENHANCED menu from TRIGGER on the top menu that is displayed.
2. Press the **Type** soft key. Select **User Define** from the setup menu that is displayed. The menu that appears varies depending on whether the clock is set on or off.

When the Clock Is Off

Set the trigger type to User Define.



Data Source (Source)

Press the **Source** soft key. The following menu items appear.

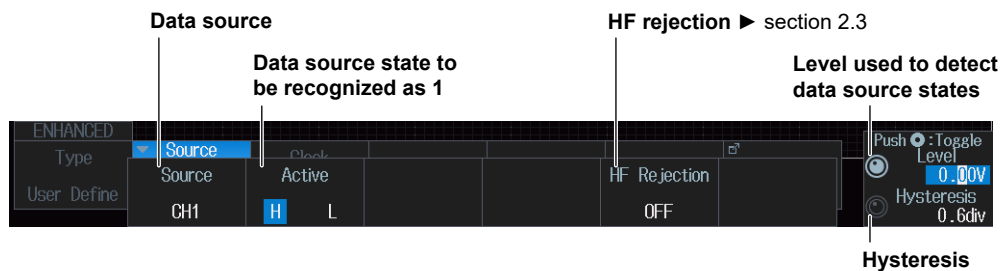

Set the data source to compare with the pattern specified as a trigger condition.

Trigger Condition (Condition Setup)

Press the **Condition Setup** soft key. The following screen appears.

You can use data patterns as trigger conditions. The data pattern trigger condition is met when the sampled data source pattern matches the specified pattern.

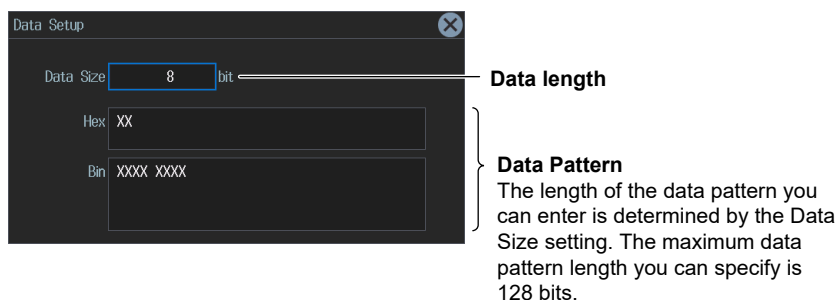

When the Clock Is On

Set the trigger type to User Define.

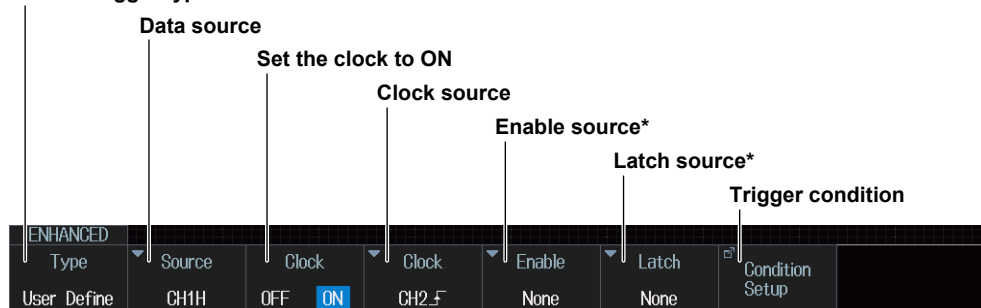

* The enable source and latch source can be set only for 4-channel models.

Data Source (Source)

The menu is the same as the one shown on the previous page for when the clock is off.

Clock Source (Clock)

Press the **Clock** soft key. The following menu items appear.

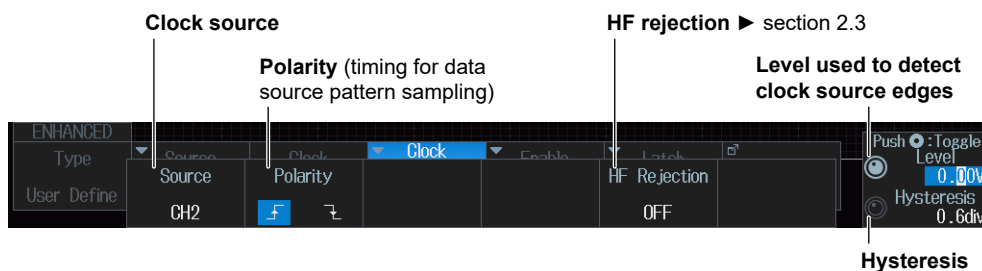

Specify which clock source edge causes the data source to be sampled.

2.23 Triggering On User-Defined Serial Bus Signals

Enable Source(Enable)

Press the **Enable** soft key. The following menu items appear.

Enable source (when None)

When the enable source is one of CH1 to CH4

Level used to detect enable source states

State of the enable source to be recognized as the data source

HF rejection ► section 2.3

Hysteresis

When the data source is sampled in sync with the clock source, the enable source can be used to control the period for which the instrument tests the data source.

Latch Source (Latch)

Press the **Latch** soft key. The following menu items appear.

Latch source (when None)

When the latch source is one of CH1 to CH4

Level used to detect latch source edges

Polarity (timing for data source pattern comparison)

HF rejection ► section 2.3

Hysteresis

You can specify the timing at which the data source pattern sampled in sync with the clock source is compared with the specified pattern.

Trigger Condition (Condition Setup)

The menu is the same as the one shown on the previous page for when the clock is off.

2.24 Triggering on a TV Trigger

This section explains the following settings for triggering on a TV trigger:

- Broadcasting System
- Trigger source
 - Polarity, HF rejection, horizontal sync frequency, sync guard frequency
- Polarity
- Resolution
- Line number
 - Field number, frame skip
- Level used to detect trigger source states

► “TV Trigger [ENHANCED]” in the Features Guide

ENHANCED TV Menu

1. Press **ENHANCED**. The ENHANCED menu appears.
You can also tap **MENU** (E) in the upper left of the screen and select the ENHANCED menu from TRIGGER on the top menu that is displayed.
2. Press the **Type** soft key. Select **TV** from the setup menu that is displayed. The following menu items appear.

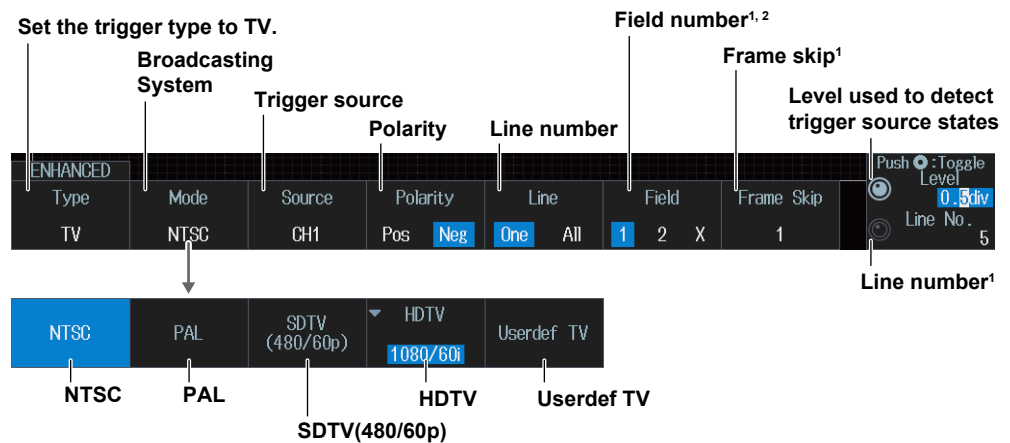

- 1 You can set this when the line number is set to One.
- 2 You can set these only when the broadcasting system is set to NTSC, PAL, HDTV (1080/60i, 1080/50i, 1080/24sF), or Userdef TV. For details on Userdef TV, see “Userdef TV” on the next page.

Broadcasting System (Mode)

NTSC

Press the **Mode** soft key and then the **NTSC** soft key. The instrument triggers using the specified field and line of the NTSC signal as trigger conditions.

PAL

Press the **Mode** soft key and then the **PAL** soft key. The instrument triggers using the specified field and line of the PAL signal as trigger conditions.

2.24 Triggering on a TV Trigger

SDTV(480/60p)

Press the **Mode** soft key and then the **SDTV(480/60p)** soft key. The instrument triggers using the specified line of the SDTV signal as trigger conditions.

HDTV

Press the **Mode** soft key and then the **HDTV** soft key. The following menu appears. Select the video format. The instrument triggers using the specified field and line of the HDTV signal as trigger conditions.

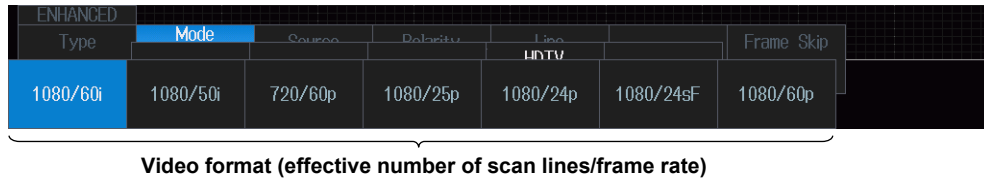

Userdef TV

Press the **Mode** soft key and then the **Userdef TV** soft key. The following menu items appear. The instrument triggers using the user-defined field and line as trigger conditions.

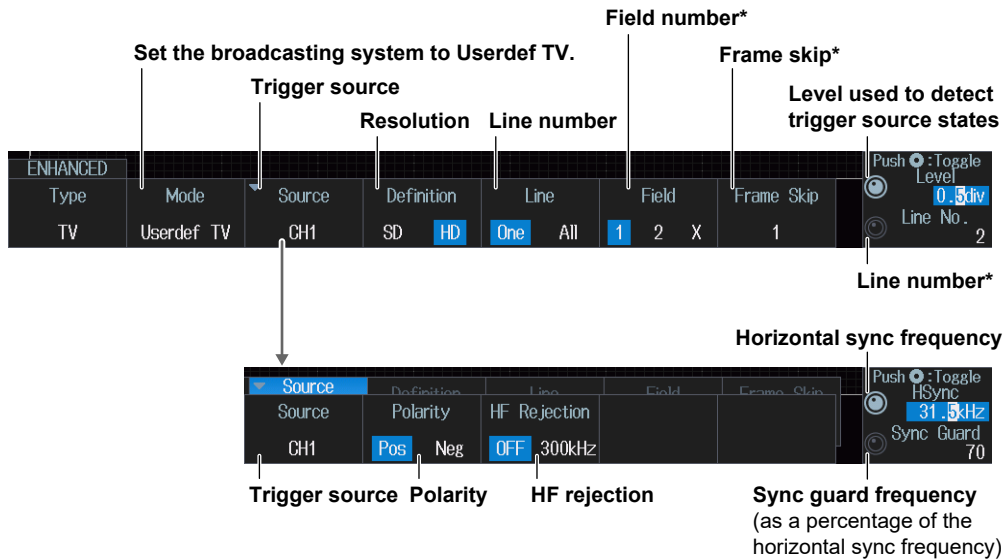

* You can set this when the line number is set to One.

2.25 Triggering on Combination Triggers (B TRIG)

This section explains the following settings for triggering on a combination trigger:

- Logic combination
Delay time for condition B, number of times condition B must be met
- A trigger: Condition A
- B trigger: condition B

► “Trigger B [B TRIG]” in the Features Guide

B TRIG menu

Press **B TRIG**. The following menu items appear.

You can also tap **MENU** (ⓘ) in the upper left of the screen and select the B TRIG menu from TRIGGER on the top menu that is displayed.

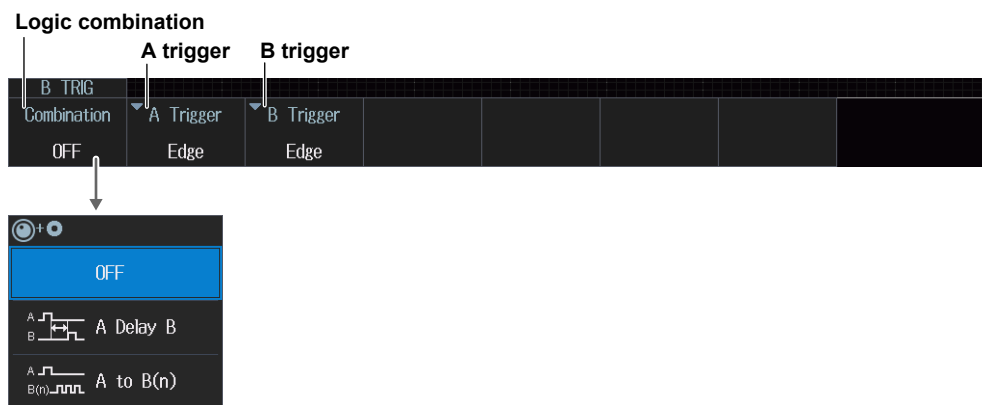

Logic Combination (Combination)

OFF

Press the **Combination** soft key and then the **OFF** soft key.
The instrument triggers when the trigger A conditions are met.

A Delay B

Press the **Combination** soft key and then the **A Delay B** soft key. The following menu items appear.



After the trigger A conditions are met and the specified amount of time (the delay time) elapses, the instrument triggers when the trigger B conditions are met.

A to B(n)

Press the **Combination** soft key and then the **A to B(n)** soft key. The following menu items appear.



After the trigger A conditions are met, the instrument triggers when the trigger B conditions are met N times.

2.25 Triggering on Combination Triggers (B TRIG)

Trigger A (A Trigger)

Press the **A Trigger** soft key. The following menu items appear.

Trigger condition A is set to the trigger condition that has been set with the EDGE key or the ENHANCED key, whichever one is illuminated. You can also set trigger condition A from the following menu.

Trigger type

The specified trigger type menu appears.

For information on setting each trigger type, see its corresponding reference in the following table.



Trigger type	Reference Section	Trigger Type	Reference Section	Trigger Type	Reference Section
Edge	Section 2.3	Window OR	Section 2.11	PSI5 Airbag	Section 2.19
Edge OR	Section 2.4	Interval	Section 2.12	UART	Section 2.20
Pattern	Section 2.5	FlexRay	Section 2.13	I2C	Section 2.21
Pulse Width	Section 2.6	CAN	Section 2.14	SPI	Section 2.22
Rise/Fall Time	Section 2.7	CAN FD	Section 2.15	User-defined serial bus	Section 2.23
Runt	Section 2.8	LIN	Section 2.16	TV	Section 2.24
Timeout	Section 2.9	CXPI	Section 2.17		
Window	Section 2.10	SENT	Section 2.18		

Note

Only one of either condition A or condition B can be set for serial bus trigger.

Trigger B (B Trigger)

Press the **B Trigger** soft key. The following menu items appear.

Set trigger B to one of the trigger types shown in the following table.

Trigger type

The specified trigger type menu appears.

For information on setting each trigger type, see its corresponding reference in the following table.



Trigger Type	Reference Section	Trigger Type	Reference Section	Trigger Type	Reference Section
Edge	Section 2.3	CAN	Section 2.14	UART	Section 2.20
Edge OR	Section 2.4	CAN FD	Section 2.15	I2C	Section 2.21
Pattern	Section 2.5	LIN	Section 2.16	SPI	Section 2.22
Window	Section 2.10	CXPI	Section 2.17	User-defined serial bus	Section 2.23
Window OR	Section 2.11	SENT	Section 2.18		
FlexRay	Section 2.13	PSI5 Airbag	Section 2.19		

Note

- Only one of either condition A or condition B can be set for serial bus trigger.
- If you set condition B as the Window trigger, Time Qualification is fixed to None.
- If you set condition B as the Pattern trigger, True and False cannot be selected as the trigger condition when the clock source has been set to None.

2.26 Forcing the Instrument to Trigger (FORCE TRIG)

▶ [“Trigger Types \(Type\)” in the Features Guide](#)

Press **SHIFT+B TRIG** (FORCE TRIG).

You can also tap **MENU**  in the upper left of the screen and select the FORCE TRIG menu from TRIGGER on the top menu that is displayed.

2.27 Setting the Action-On-Trigger Function

This section explains the following settings for executing the action-on-trigger function):

- Action mode
- Action to execute
- The number of actions
- Executing action-on trigger

► “Executing Actions” in the Features Guide

ACTION Action on Trig Menu

1. Press **SHIFT+MODE** (ACTION GO/NO-GO). The ACTION menu appears.
You can also tap **MENU** (☰) in the upper left of the screen and select the ACTION menu (ACTION GO/NO-GO) from TRIGGER on the top menu that is displayed.
2. Press the **Mode** soft key and then the **Action on Trig** soft key. The following menu items appear.

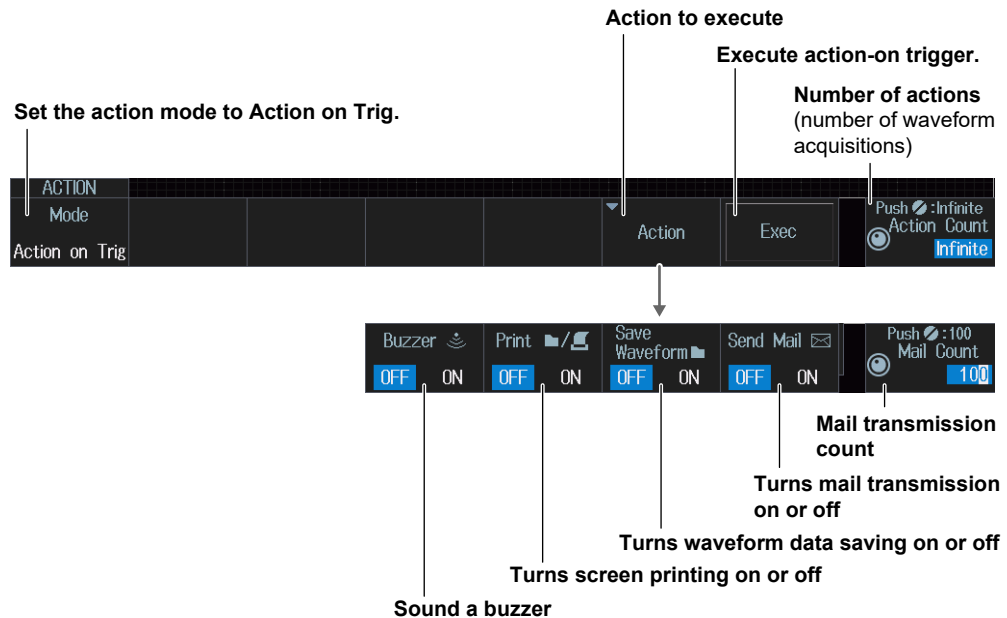

Executing Action-on Trigger (Exec)

After specifying the action mode, the action to execute, and the number of actions, press the **Exec** soft key. The instrument executes the action each time it triggers until the specified number of actions has been reached.

While action-on-trigger is being executed, Exec changes to Abort. If you want to stop serial bus configuration, press the **Abort** soft key.

Note

- You cannot execute action-on-trigger if Print To is set to Multi when Print is set to ON on the PRINT menu.
► section 16.6
- When the action to execute is e-mail transmission, the instrument sends the number of messages specified by either Action Count or Mail Count, whichever is lower.

2.28 Performing GO/NO-GO Determination

This section explains the following settings for performing GO/NO-GO determination:

- Action mode
- The number of NO-GO determinations
- Reference condition
 - Reference range type, determination source waveform, reference condition, determination source window, and zone settings
- Executing Go/NO-GO determination

► “Executing Actions” in the Features Guide

ACTION Go/Nogo Menu

1. Press **SHIFT+MODE** (ACTION GO/NO-GO). The ACTION menu appears.
You can also tap **MENU** (M) in the upper left of the screen and select the ACTION menu (ACTION GO/NO-GO) from TRIGGER on the top menu that is displayed.
2. Press the **Mode** soft key, then the **Go/Nogo AND** or **Go/Nogo OR** soft key. The following menu items appear.

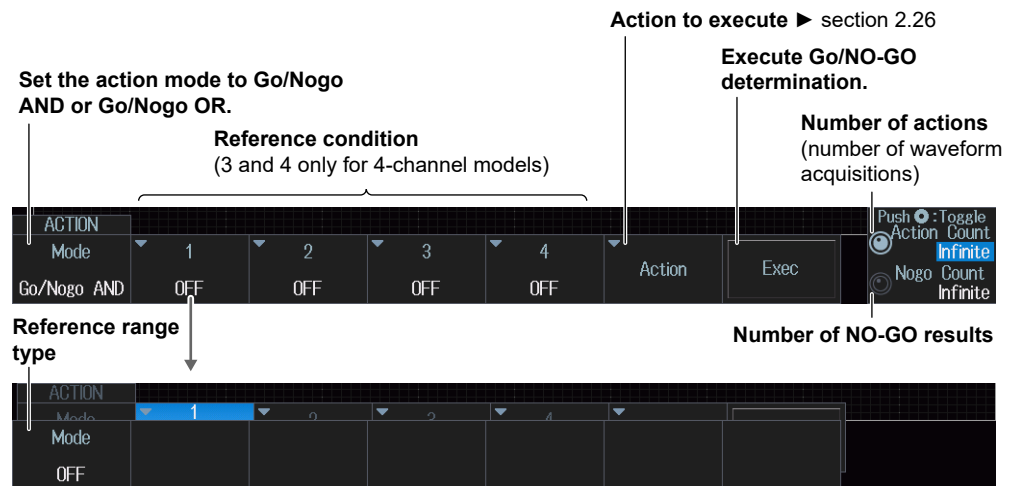

Executing Go/NO-GO Determination (Exec)

After specifying the action mode, the action to execute, the number of actions, the number of NO-GO determinations, and the reference conditions, press the **Exec** soft key. The instrument executes actions until either the specified number of actions or the number of NO-GO determinations is reached.

While GO/NO-GO determination is being executed, Exec changes to Abort. If you want to stop serial bus configuration, press the **Abort** soft key.

Note

- You cannot execute GO/NO-GO determination if Print To is set to Multi when Print is set to ON on the PRINT menu. ► section 16.6
- When the action to execute is e-mail transmission, the instrument sends the number of messages specified by either Action Count or Mail Count, whichever is lower.

Reference Conditions (1 to 4) Reference Range Type (Mode)

Press any one of the Reference Condition 1 to 4 soft keys. The following menu items appear.

Reference range type

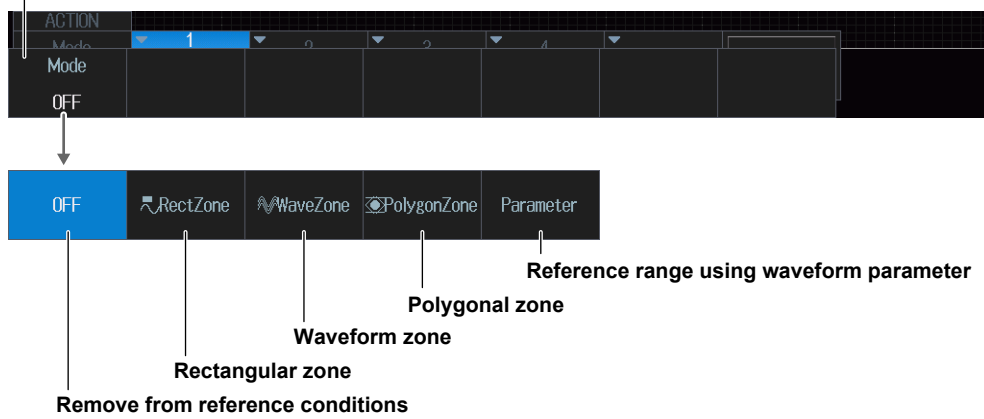

Under the following circumstances, there are reference range types that you cannot specify.

- When the judgment target waveform is LOGIC, XY1, XY2, FFT1, or FFT2

Source Waveform	Reference range type			
	Rectangular zone	Waveform zone	polygonal zone	Reference range using waveform parameter
CH1 to CH4	Yes	Yes	Yes	Yes
LOGIC	No	No	No	Yes
Math1 to Math4	Yes	Yes	Yes	Yes
XY1, XY2	Yes	No	Yes	Yes
FFT1, FFT2	No	No	No	Yes

Note

Using the CH4 Terminal and Logic Signal Input Port

When you perform GO/NO-GO determination, you cannot use the CH4 terminal and logic signal input ports as the source at the same time. Specify the source that you want to use in advance by pressing either CH4 or LOGIC.

Rectangular Zone (RectZone)

Press the **Mode** soft key and then the **RectZone** soft key. The following menu items appear.

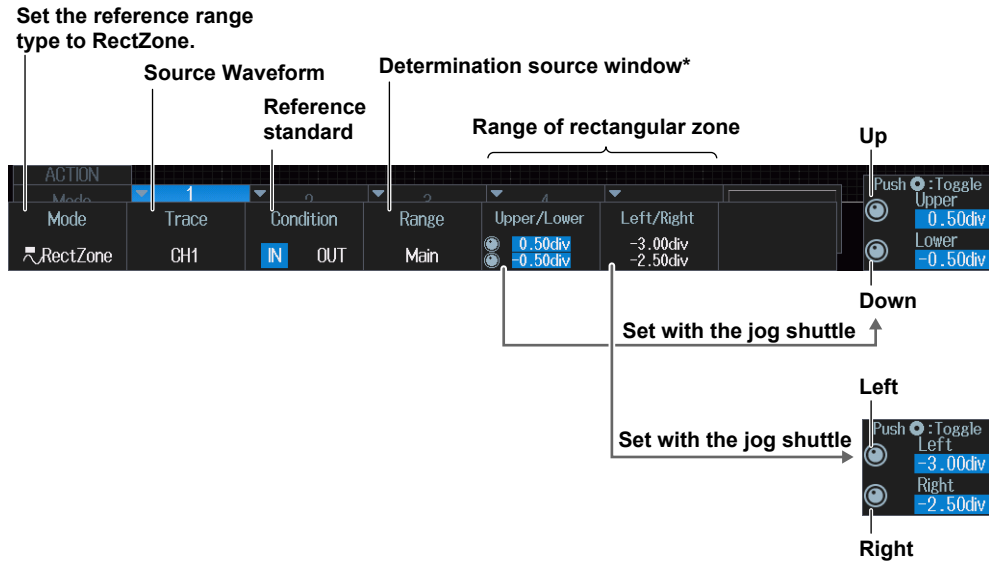

* Set this when the source waveform is CH1 to CH4 or Math1 to Math4.

Note

- To move the rectangular zone up and down, press the Upper or Lower soft key or the SET key several times, and rotate the jog shuttle with both the up and down cursor selected.
- To move the rectangular zone left and right, press the Left or Right soft key or the SET key several times, and rotate the jog shuttle with both the left and right cursors selected.

Waveform Zone (WaveZone)

Press the **Mode** soft key and then the **WaveZone** soft key. The following menu items appear.

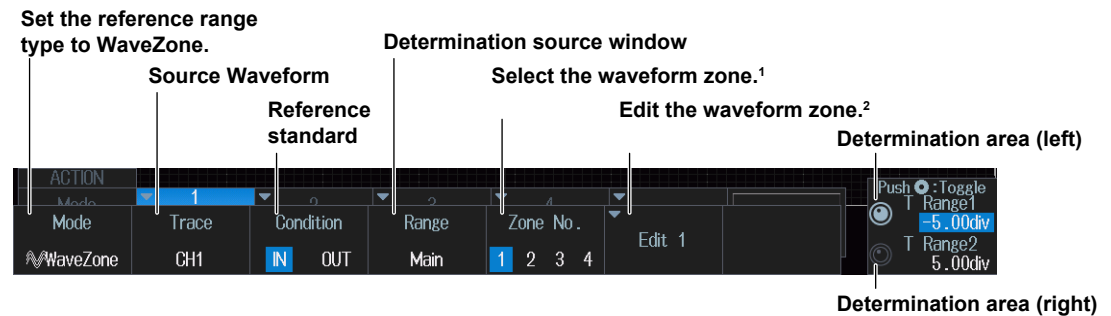

- Select the waveform zone to be used for reference and the waveform zone to edit.
- It takes a few seconds to switch to the editing screen.

Editing a Waveform Zone (Edit1 to 4)

1. Press the **Zone No.** soft key, and select the number of the waveform zone that you want to edit. The soft key for editing the waveform zone will change (to Edit 1, 2, 3, or 4) according to the selected number.
2. Of **Edit 1 to Edit 4**, press the soft key that appears on the menu. The waveform zone editing menu for the number that you selected will be displayed.

1 If you change the base waveform, all the zones that you have edited up to that point are lost.

2 It takes a few seconds to return to the previous menu from the editing screen.

Changing the Base Waveform

To perform editing without changing the base waveform, proceed to Step 5.

3. Press the **Trace (New)** soft key and select the waveform to serve as the base waveform from the menu that is displayed.
4. Press the **Exec (New)** soft key. A waveform zone will be created.

Editing the Entire Waveform Zone

5. Press the **Edit** soft key and select **Whole**.
6. Press the **Upper/Lower** soft key or the **Left/Right** soft key to select the direction to edit.
7. Turn the jog shuttle to edit the waveform zone.

Editing a Part of the Waveform Zone

5. Press the **Edit** soft key and select **Part**.
6. Using the **T Range1/2** soft key and the jog shuttle, set the waveform zone range you want to edit.
 - T Range1/2 soft key: Select the target you want to set: the left edge of the edit range, the right edge, or both.
 - Jog shuttle: Set the left edge of the edit range, the right edge, or both.
7. Press the **Upper/Lower** soft key to select the direction to edit.
8. Turn the jog shuttle to edit the waveform zone.
9. Repeat steps 6 to 8.

Confirming the Waveform Zone

Press the **Store** soft key.

Confirm the edited waveform zone and store it in internal memory.

Finishing Editing

Press the **Quit** soft key.

Return to the previous menu from the editing screen. If you do not confirm the edited waveform zone by pressing the **Store** soft key, the changes that you made will be lost.

Note

- If you change the base waveform, all the zones that you have edited up to that point will be lost.
- If you want to move from the editing menu to a different menu, you have to press the Quit soft key to finish editing.

Polygonal Zone (PolygonZone)

Press the **Mode** soft key and then the **PolygonZone** soft key. The following menu items appear.

Set the reference range type to PolygonZone.

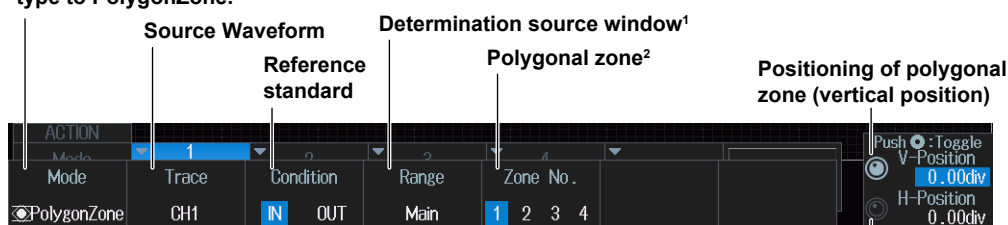

Positioning of polygonal zone (horizontal position)

- 1 Set this when the source waveform is CH1 to CH4 or Math1 to Math4.
- 2 GO/NO-GO determination is performed using the polygonal zone that you specify here.

Use the Mask Editor software on a PC in advance to create the polygonal images that you will use as polygonal zones. After loading the file (see section 17.7) and loading the polygonal image into the specified zone number (Zone No. 1 to 4), configure the polygonal zone GO/NO-GO determination.

Setting a Reference Range Using Waveform Parameters (Parameter)

Note

Using the CH4 Terminal and Logic Signal Input Port

When you perform GO/NO-GO determination, you cannot use the CH4 terminal and logic signal input ports as the source at the same time. Specify the source that you want to use in advance by pressing either CH4 or LOGIC.

Press the **Mode** soft key and then the **Parameter** soft key. A menu appears according to the specified determination source waveform.

When CH1 to CH4 or Math1 to Math4 Is the Determination Source Waveform

You can select the measurement item to use in the GO/NO-GO determination from the automatically measured waveform parameters. For information on setting automated measurement of waveform parameters, see section 9.1.

Set the reference range type to **Parameter**.

The image shows two screenshots from an oscilloscope interface. The top screenshot is the main menu for setting a reference range. It has a 'Mode' dropdown set to '1' and a 'Parameter' dropdown set to 'CH1'. The 'Condition' section has 'IN' and 'OUT' options. The 'Item' dropdown is set to 'Max'. On the right, there are two push buttons: 'Upper' with a value of '0.00000' and 'Lower' with a value of '0.00000'. Labels with arrows point to these elements: 'Set the determination source waveform to one of CH1 to CH4 or one of Math1 to Math4' points to the 'Mode' dropdown; 'Reference standard' points to the 'Parameter' dropdown; 'Measurement items to use for the GO/NO-GO determination' points to the 'Item' dropdown; 'Reference range (upper limit)' points to the 'Upper' button; and 'Reference range (lower limit)' points to the 'Lower' button.

The bottom screenshot is the 'Item Setup' dialog. It contains a grid of measurement items, each with a radio button and a waveform icon. The 'Max' item is selected. Other items include Min, P-P, High, Low, Amplitude, Rms, Mean, Sdev (AC RMS), +Over, -Over, Pulse Count, Edge Count, V1, V2, ΔT, IntegTY+, IntegTY-, Freq, Period, Avg Freq, Avg Period, Burst, Rise, Fall, +Width, -Width, Duty, and Delay. A 'Set' button is at the bottom right. A label 'Enters the selected measurement items' points to the 'Set' button.

When the Determination Source Waveform Is LOGIC (On models with the logic signal input port)

You can select the measurement item to use in the GO/NO-GO determination from the items used for time axis measurement of waveform parameters shown below. For information on setting automated measurement of waveform parameters, see section 9.1.

Freq, Period, Avg Freq, Duty, Pulse Count, Delay

Set the reference range type to Parameter.

Set the determination source waveform to LOGIC.

Source bit

Measurement items to use for the GO/NO-GO determination

Reference range (upper limit)

Reference range (lower limit)

Enters the selected measurement items

When XY1 or XY2 Is the Source Waveform

The measurement item to use in the GO/NO-GO determination is the area of XY1 or XY2. For information on setting how the XY waveform is displayed and how its area is determined, see Chapter 5 of this manual and appendix 1 of the *Features Guide*, IM DLM3054-01EN.

Set the reference range type to Parameter.

Set the determination source waveform to XY1 or XY2.

Reference standard

Reference range (upper limit)

Reference range (lower limit)

When FFT1 or FFT2 Is the Source Waveform

You can select the measurement item to use in the GO/NO-GO determination from the peak cursor measurement items (Freq, V) for FFT. For details on peak cursor measurement, see section 7.2.

Set the reference range type to Parameter.

Set the determination source waveform to FFT1 or FFT2.

Reference standard

Measurement items to use for the GO/NO-GO determination

Reference range (upper limit)

Reference range (lower limit)

Enters the selected measurement items

3.1 Setting Conditions for Waveform Acquisition

This section explains the following settings for acquiring waveforms:

- Record length
- Acquisition mode
- trigger mode
- Turning high resolution mode on or off
- Sampling mode
- Number of waveforms to acquire, attenuation constant, and number of times to average

► [“Waveform Acquisition” in the Features Guide](#)

ACQUIRE Menu

Press **ACQUIRE**. The following menu items appear.

You can also tap **MENU** (☰) in the upper left of the screen and select the ACQUIRE menu from ACQ/DISP on the top menu that is displayed.

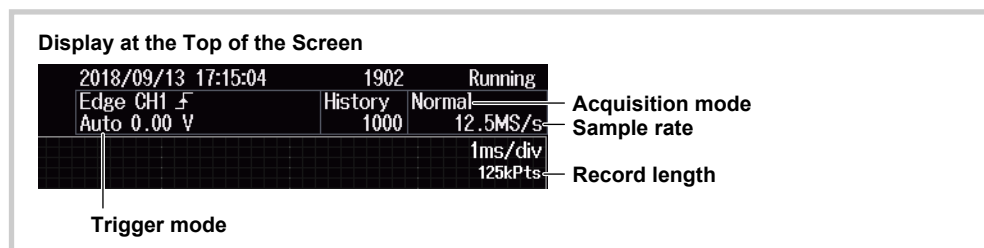
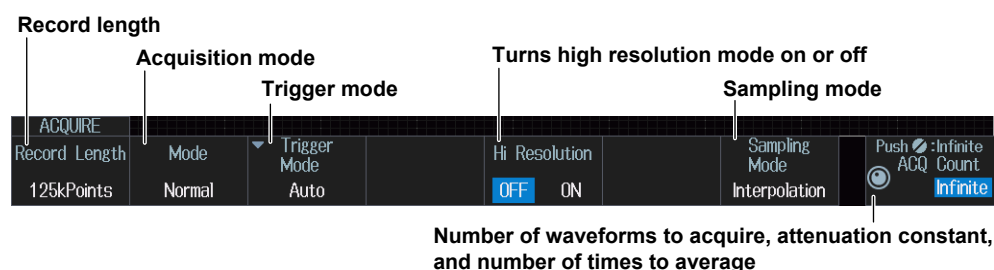

Acquisition Mode (Mode)

- Normal:** Displays waveforms without processing the sampled data. You can set the number of waveforms to acquire with the jog shuttle.
- Envelope:** Displays waveforms in envelope mode. You can set the number of waveforms to acquire with the jog shuttle.
- Average:** Displays averaged waveforms. You can set the attenuation constant and the number of times to average with the jog shuttle.

Trigger Mode (Trigger Mode)

The trigger mode determines the conditions for updating the displayed waveforms. You can also set the trigger mode by pressing the MODE key. ► section 2.1

You can set the trigger mode to one of the settings below.

Auto, Auto Level, Normal, N Single

3.1 Setting Conditions for Waveform Acquisition

Sampling Mode (Sampling Mode)

Realtime: Samples data in real-time sampling mode.

Interpolation: Samples data in interpolation mode.

Repetitive: Samples data in repetitive sampling mode.

Note

You cannot use repetitive sampling mode (Repetitive) under the following circumstances.

- When the trigger source is LOGIC
 - When the record length is 2.5 M points or more
-

3.2 Acquiring Waveforms

► “Waveform Acquisition (RUN/STOP)” and
“Acquiring the Waveform Once (SINGLE)”
in the Features Guide

Starting and Stopping Waveform Acquisition (RUN/STOP)

1. Press **RUN/STOP**.
 - The RUN/STOP key illuminates, and waveform acquisition starts. The acquired waveform is displayed.
 - If you set the record length to a value that allows only one waveform to be acquired, pressing the RUN/STOP key will produce the same result as pressing the SINGLE key.
 - You can also tap **MENU** (☰) in the upper left of the screen and select the RUN/STOP menu from the top menu that is displayed.
2. Press **RUN/STOP** again.

The RUN/STOP key light turns off, and waveform acquisition stops.

Acquiring a Waveform Once (SINGLE)

1. Press **SINGLE**.
 - When SINGLE illuminates and the instrument triggers, it acquires and displays only one waveform and then stops waveform acquisition. The SINGLE key light turns off.
 - You can also tap **MENU** (☰) in the upper left of the screen and select the SINGLE menu from the top menu that is displayed.
 - The trigger mode is set to single mode.
 - To stop waveform acquisition, press the RUN/STOP key.

4.1 Setting Display Conditions

This section explains the following settings for viewing the display:

- Display format
- Display interpolation
- Grid
- Turning scale value display on or off
- Waveform mapping
- Color
- Waveform intensity

▶ “Display” in the Features Guide

DISPLAY Menu

Press **DISPLAY**. The following menu items appear.

You can also tap **MENU** (M) in the upper left of the screen and select the DISPLAY menu from ACQ/ DISP on the top menu that is displayed.

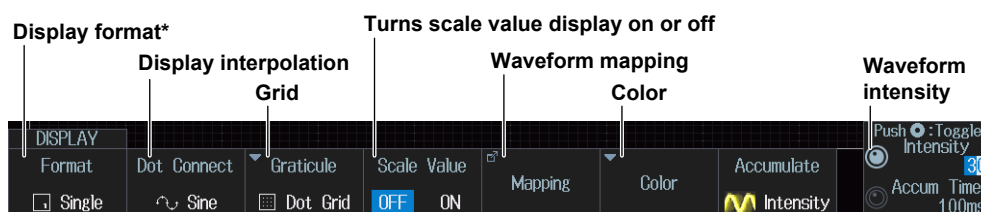

* Quad, Hexa, and Octal can be set only for 4-channel models.

Grid (Graticule)

Press the **Graticule** soft key. The following menu items appear.

Display the grid with dotted lines.

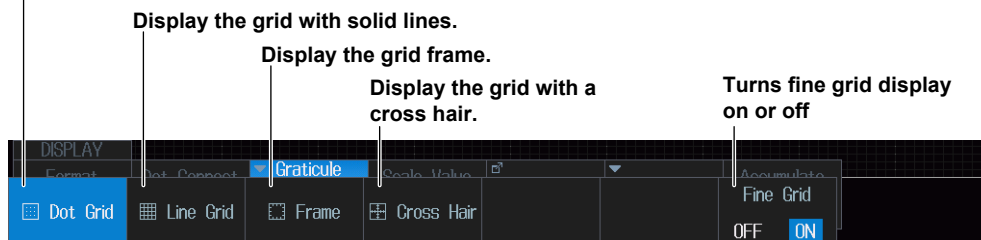

Waveform Mapping (Mapping)

Press the **Mapping** soft key. The following menu items appear.

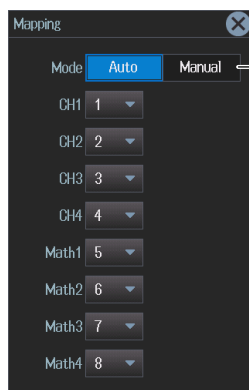

Mapping mode

When the waveform mapping mode is set to Manual, set how to map each channel's waveform to the divided screens.*

* CH4 or LOGIC, whichever the corresponding key is illuminated, can be selected. Specify the channel that you want to set in advance by pressing either the CH4 key or the LOGIC key.

4.1 Setting Display Conditions

Display Color (Color)

Press the **Color** soft key. The following menu items appear.

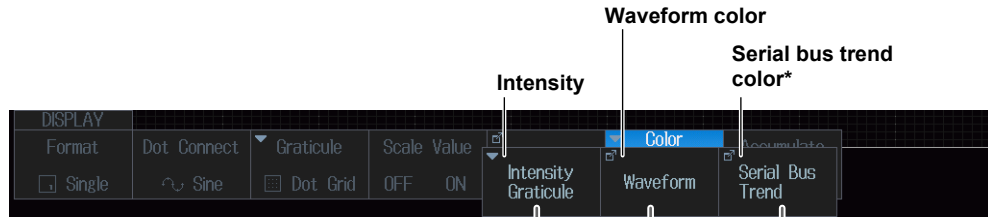

* This menu appears on models with the SENT or PS15 Airbag option.

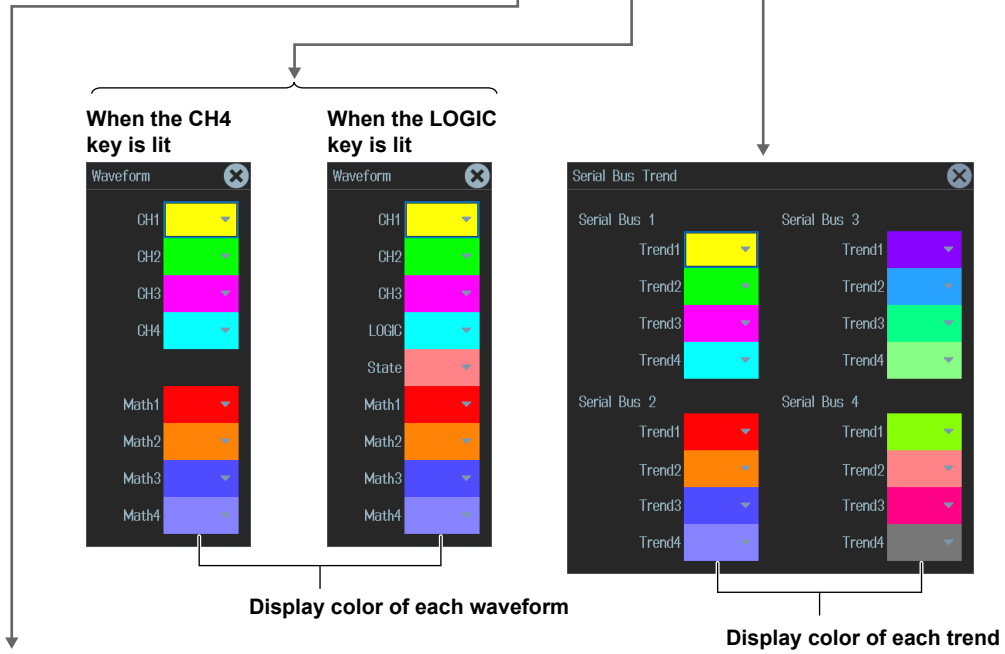

Set with the jog shuttle

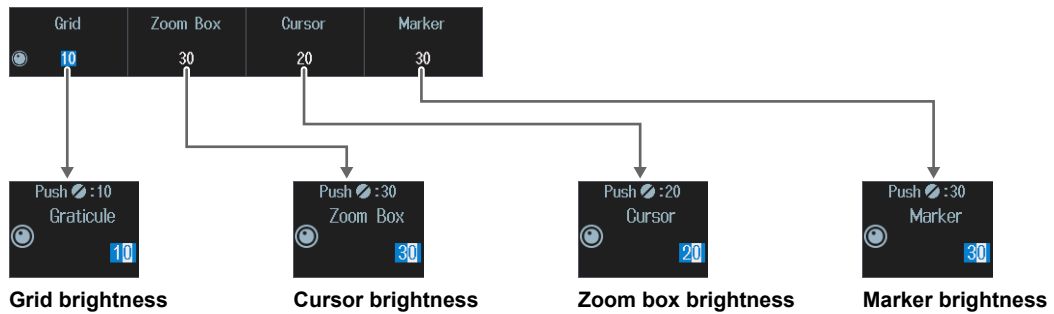

4.2 Using the Accumulate Feature

This section explains the following settings for using the accumulate feature:

- Gradation mode (accumulate display on/off)
- Waveform intensity, accumulation time

► [“Accumulation \(Accumulate\)” in the Features Guide](#)

DISPLAY Menu

Press **DISPLAY**. The following menu items appear.

You can also tap **MENU** (☰) in the upper left of the screen and select the DISPLAY menu from ACQ/ DISP on the top menu that is displayed.

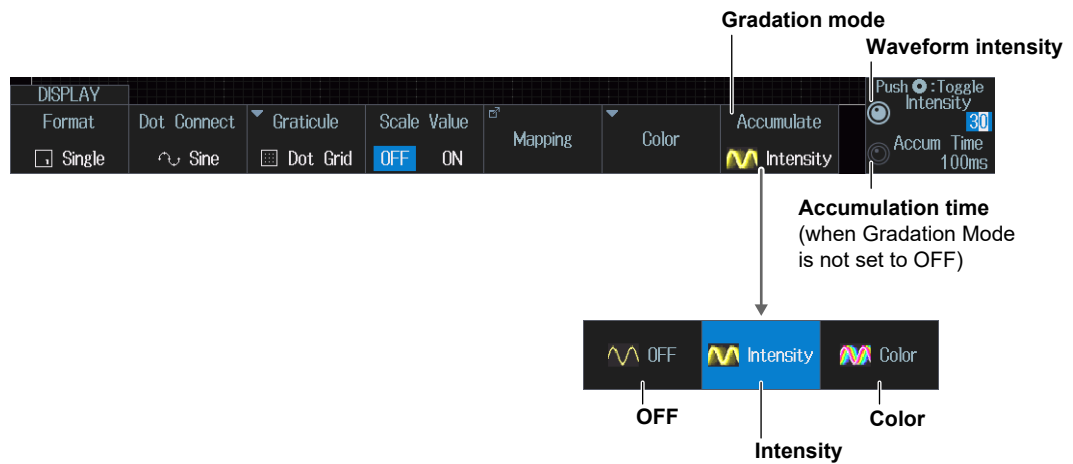

Gradation Mode (Accumulate)

Intensity: Indicates waveform frequency using different intensity levels.



Color: Indicates waveform frequency using different colors.

OFF: Does not accumulate waveforms.

4.3 Using the Snapshot and Clear Trace Features

► “Snapshot (SNAP SHOT)” and
“Clear Trace (CLEAR TRACE)” in the Features Guide

Snapshot (SNAP SHOT)

1. Press .
 - Press SNAPSHOT to retain the currently displayed waveform on the screen as a snapshot displayed in white. Snapshot waveforms remain on the screen until you execute a clear trace operation.
 - You can also tap **MENU**  in the upper left of the screen and select the SNAP SHOT menu from the top menu that is displayed.

Clear Trace (CLEAR TRACE)

2. Press **CLR**.
 - Clears all the waveforms that are displayed on the screen.
 - You can also tap **MENU**  in the upper left of the screen and select the CLEAR TRACE menu from the top menu that is displayed.

4.4 Adjusting the Backlight

This section explains the following settings for adjusting the backlight):

- Turn off the backlight.
- Enabling or disabling automatic turning off of the backlight
Auto-off time
- Adjusting the brightness

▶ “System Configuration (System Configuration)” in the Features Guide

UTILITY System Configuration Menu

1. Press **UTIL**. The UTILITY menu appears.
You can also tap **MENU** (☰) in the upper left of the screen and select the UTILITY menu from UTILITY on the top menu that is displayed.
2. Press the **System Configuration** soft key. The following menu items appear.

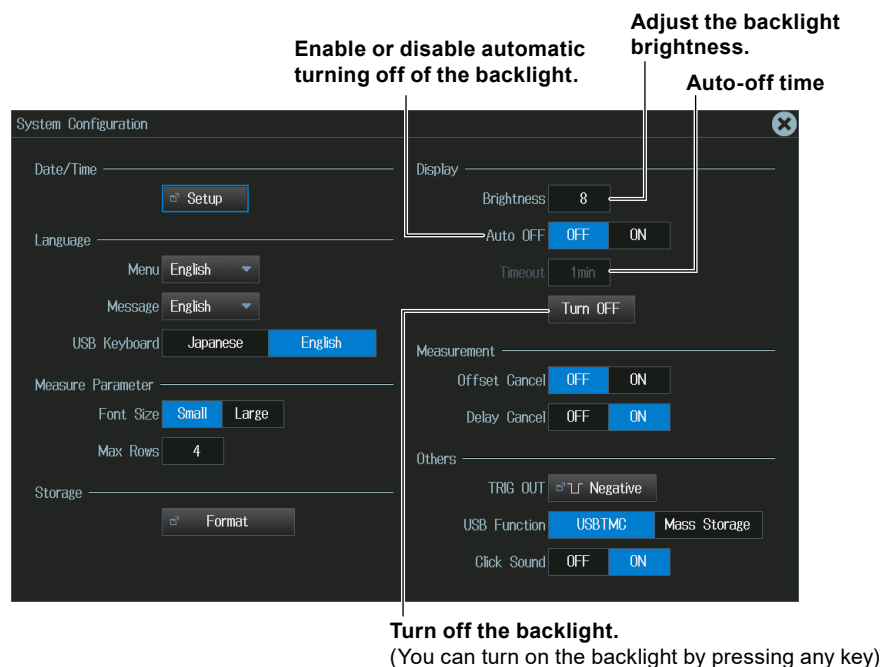

5.1 Displaying XY Waveforms

This section explains the following settings for displaying XY waveforms:

- XY waveform display
- X-axis and Y-axis source waveforms
- Display setup
 - Turning VT waveform display and split display on or off
- Measurement source window
- Display range

► “Displaying XY Waveforms” in the Features Guide

X-Y Menu

Press **SHIFT+DISPLAY(X-Y)**. The following menu items appear.

- You can also tap **MENU** (☰) in the upper left of the screen and select the X-Y menu from ACQ/DISP on the top menu that is displayed.
- Up to two XY waveforms can be displayed. To switch the setup menu, press the **XY** soft key.

Select whether to set XY1 or XY2.*

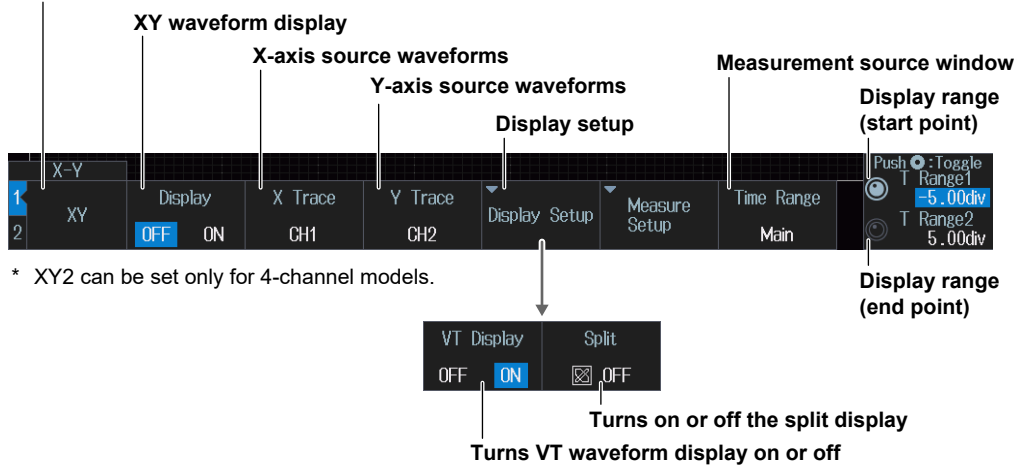

5.2 Performing Cursor Measurements and Area Calculations

This section explains the following settings for performing cursor measurements on and determining the area of the displayed XY waveform):

- Cursor measurement
- Area determination method

► “Measurement (Measure Setup)” in the Features Guide

XY Measure Setup menu

1. Press **SHIFT+DISPLAY(X-Y)**. The X-Y menu appears.
You can also tap **MENU** (☰) in the upper left of the screen and select the X-Y menu from ACQ/DISP on the top menu that is displayed.
2. Press the **Measure Setup** soft key and then the **Mode** soft key. The following menu items appear.

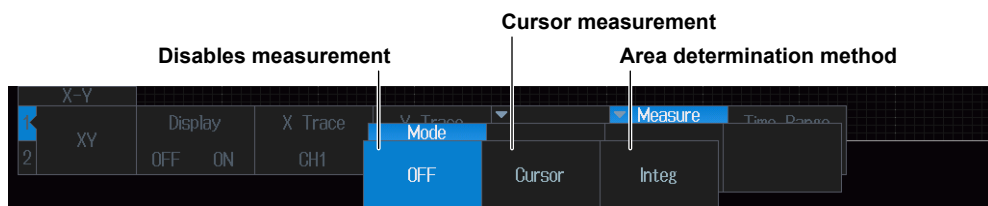

Cursor Measurement (Cursor)

Press the **Cursor** soft key. The following menu items appear.

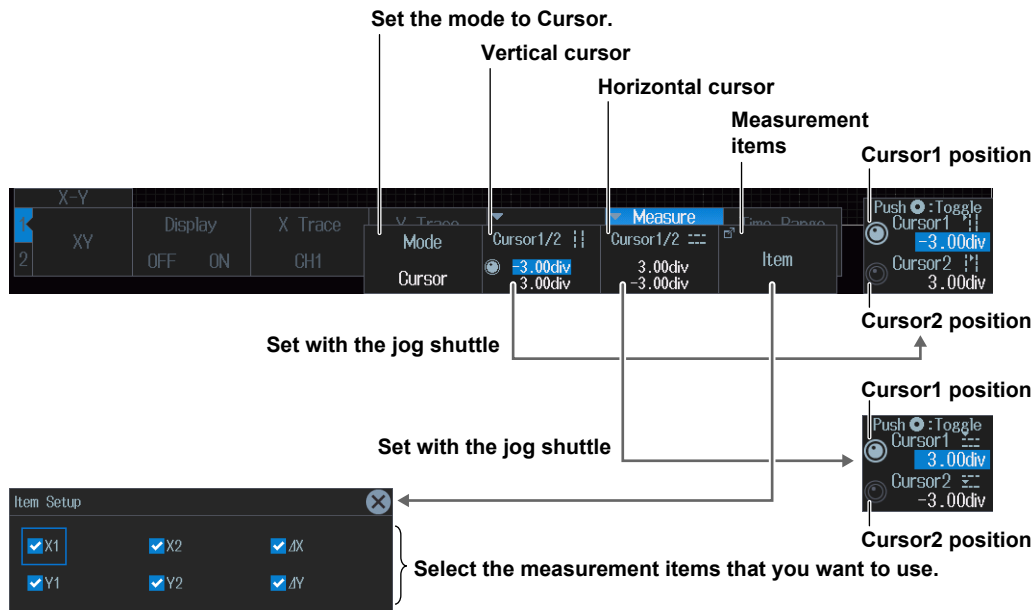

Performing Area Calculations (Integ)

Press the **Integ** soft key. The following menu items appear.

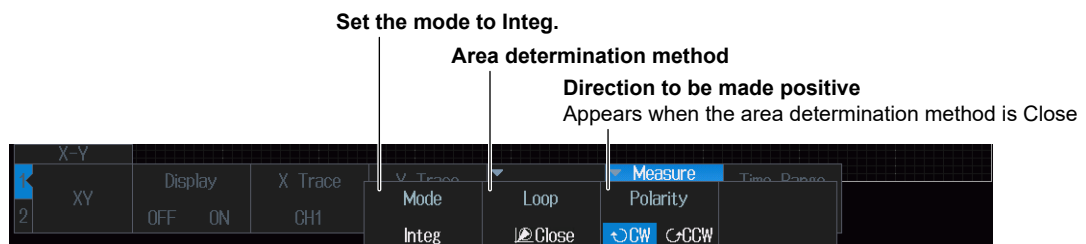

6.1 Setting the Computation Mode

This section explains how to set the computation mode.

► “Computation Mode (Mode)” in the Features Guide

MATH/REF Menu

Press **MATH/REF**. The following menu items appear.

- You can also tap **MENU** (MENU) in the upper left of the screen and select the MATH/REF menu from ANALYSIS on the top menu that is displayed.
- Up to four computed waveforms/reference waveforms can be displayed. To switch the setup menu, press the **Math/Ref** soft key.



Select the computed or reference waveform from Math/Ref1 to Math/Ref4*.

* Math/Ref3 and Math/Ref4 can be set only for 4-channel models.

Computation Mode (Mode)

Press the **Mode** soft key. The following menu items appear.

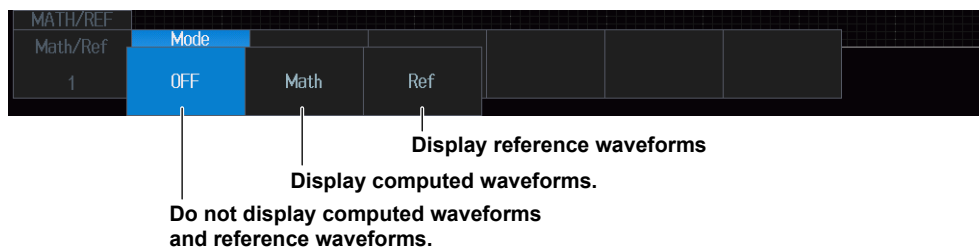

Note

- When the state display (State) of LOGIC is on, Math4/Ref4 cannot be used. ► section 1.2
- When the record length (Record Length) of the ACQUIRE menu is set to the maximum record length, Math/Ref2 and Math/Ref4 cannot be used. For details on the ACQUIRE menu, see section 3.1.

6.2 Performing Addition, Subtraction, and Multiplication

This section explains the following settings for performing addition, subtraction, and multiplication:

- Operators
- Computation source waveform

► “Operators (Operation)” in the Features Guide

MATH/REF Menu

1. Press **MATH/REF**. The MATH/REF menu appears.
 - You can also tap **MENU** (E) in the upper left of the screen and select the MATH/REF menu from ANALYSIS on the top menu that is displayed.
 - Up to four computed waveforms can be displayed. To switch the setup menu, press the **Math/Ref** soft key.
2. Press the **Mode** soft key and then the **Math** soft key.
3. Press the **Operation** soft key, then the **S1 + S2**, **S1 - S2**, or **S1 × S2** soft key. The following menu items appear.

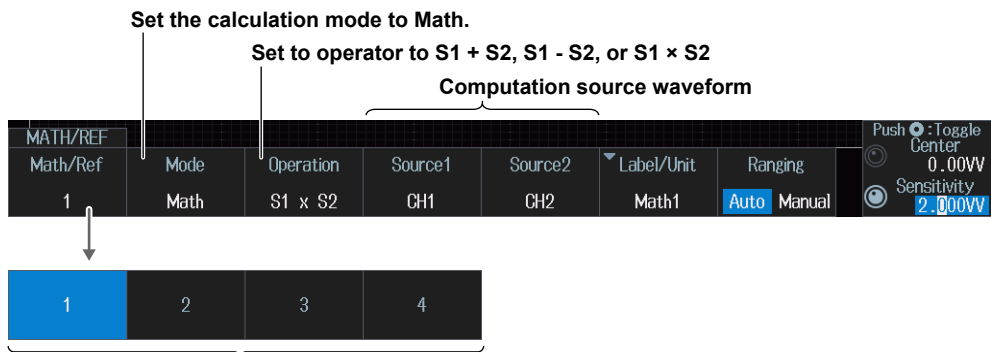

Specify the computed waveform from among Math1 to Math4.*

* Math3 and Math4 can be set only for 4-channel models.

Math Source Waveforms (Source1 and Source2)

The computation source waveforms that you can set for Source1 and Source2 are listed below.

Computed Waveforms That Display Computation Results	Source1, Source2
Math1 (Math/Ref1)	CH1 to CH4*
Math2 (Math/Ref2)	CH1 to CH4*, Math1
Math3 (Math/Ref3)	CH1 to CH4, Math1 to Math2
Math4 (Math/Ref4)	CH1 to CH4, Math1 to Math3

* CH3 and CH4 can be set only for 4-channel models.

6.3 Performing Filter Functions

This section explains the following settings for performing filter functions (phase shift, moving average, IIR filter).

- Operators
- Computation source waveform
- Filter setup

► “Operators (Operation)” in the Features Guide

MATH/REF Menu

1. Press **MATH/REF**. The MATH/REF menu appears.
 - You can also tap **MENU** (☰) in the upper left of the screen and select the MATH/REF menu from ANALYSIS on the top menu that is displayed.
 - Up to four computed waveforms can be displayed. To switch the setup menu, press the **Math/Ref** soft key.
2. Press the **Mode** soft key and then the **Math** soft key.
3. Press the **Operation** soft key and then the **Filter(S1)** soft key. The following menu items appear.

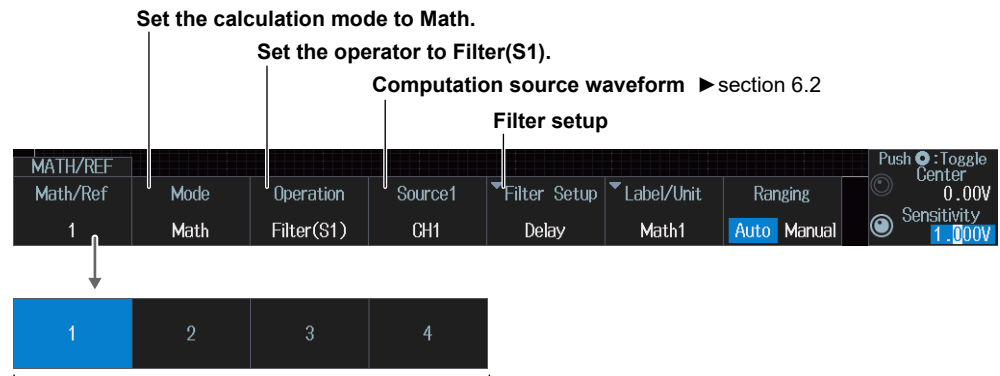

Specify the computed waveform from among Math1 to Math4.*

* Math3 and Math4 can be set only for 4-channel models.

Configuring Filters (Filter Setup)

Press the **Filter Setup** soft key. The following menu items appear.

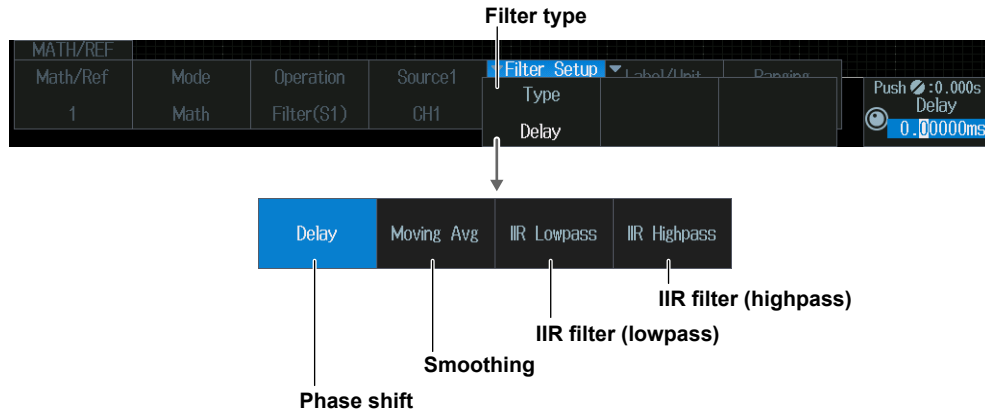

Phase Shift (Delay)

Press the **Type** soft key and then the **Delay** soft key. The following menu items appear.



Smoothing (Moving Avg)

Press the **Type** soft key and then the **Moving Avg** soft key. The following menu items appear.



IIR Filter (IIR Lowpass/IIR Highpass)

Press the **Type** soft key and then the **IIR Lowpass** or **IIR Highpass** soft key. The following menu items appear.

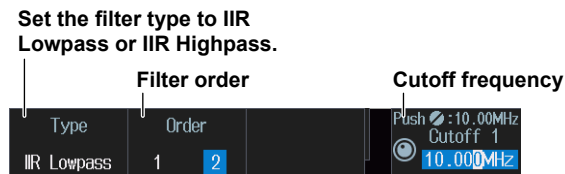

6.4 Performing Integration

This section explains the following settings for performing integration:

- Operators
- Computation source waveform
- Initial point

► “Operators (Operation)” in the Features Guide

MATH/REF Menu

1. Press **MATH/REF**. The MATH/REF menu appears.
 - You can also tap **MENU** (☰) in the upper left of the screen and select the MATH/REF menu from ANALYSIS on the top menu that is displayed.
 - Up to four computed waveforms can be displayed. To switch the setup menu, press the **Math/Ref** soft key.
2. Press the **Mode** soft key and then the **Math** soft key.
3. Press the **Operation** soft key and then the **Integ(S1)** soft key. The following menu items appear.

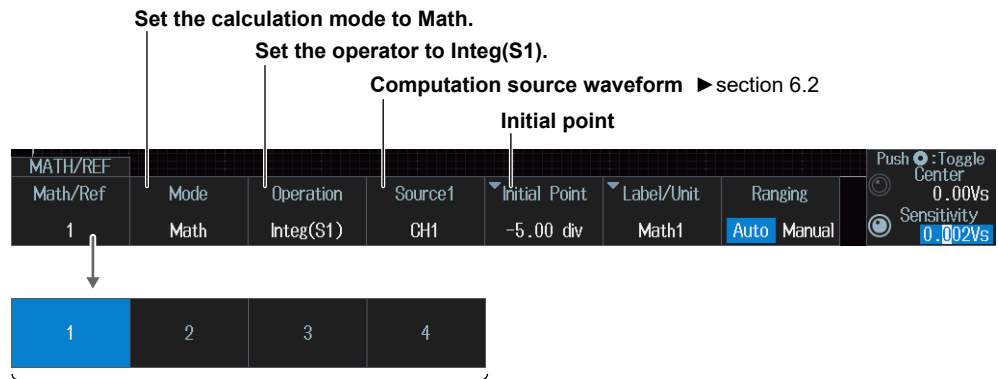

Specify the computed waveform from among Math1 to Math4.*

* Math3 and Math4 can be set only for 4-channel models.

Initial Point (Initial Point)

Press the **Initial Point** soft key. The following menu items appear.

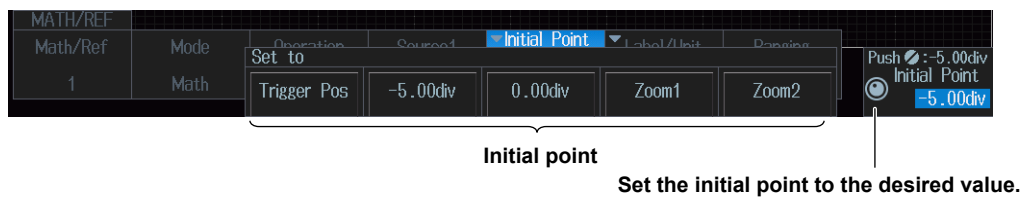

6.5 Performing Count Computations

This section explains the following settings for performing edge count or rotary count:

- Operators
- Count setup
 - Count type, computation source waveform, polarity, level used to detect edge count edges, rotary count threshold level, hysteresis
- Initial point

► “Operators (Operation)” and “Edge Count or Rotary Count (Count(S1))” in the Features Guide

MATH/REF Menu

1. Press **MATH/REF**. The MATH/REF menu appears.
 - You can also tap **MENU** (MENU) in the upper left of the screen and select the MATH/REF menu from ANALYSIS on the top menu that is displayed.
 - Up to four computed waveforms can be displayed. To switch the setup menu, press the **Math/Ref** soft key.
2. Press the **Mode** soft key and then the **Math** soft key.
3. Press the **Operation** soft key and then the **Count(S1)** soft key. The following menu items appear.

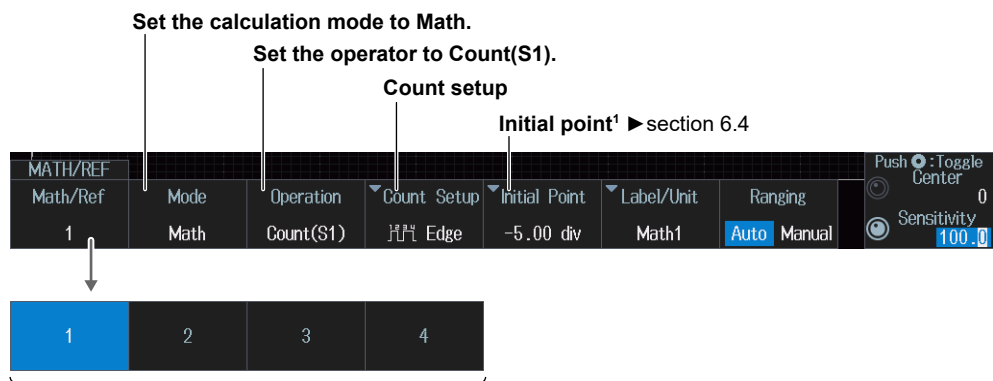

Specify the computed waveform from among Math1 to Math4.²

- 1 If the count type (Type) is rotary count, the initial point can be set only when Source3(Z) is set to None. Source3(Z) can be set only for 4-channel models.
- 2 Math3 and Math4 can be set only for 4-channel models.

Count Setup (Count Setup)

Press the **Count Setup** soft key. The following menu items appear.

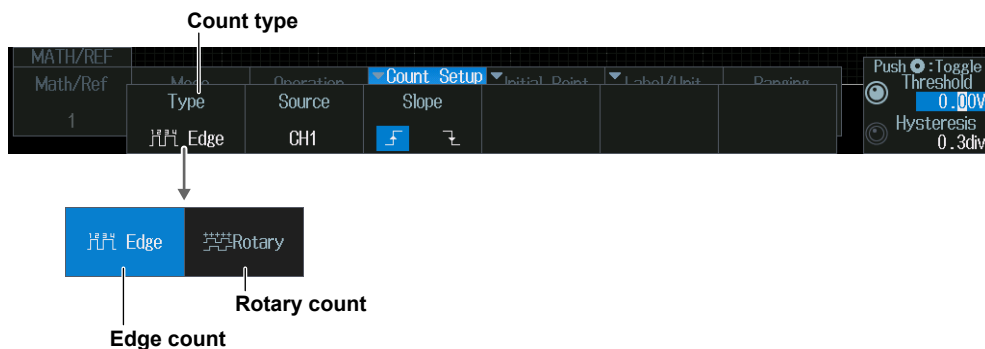

Edge Count (Edge)

Press the **Type** soft key and then the **Edge** soft key. The following menu items appear.

Set the count type to Edge.

Computation source waveform ► section 6.2

Polarity

Level used to detect edges

Hysteresis

Rotary Count (Rotary)

Press the **Type** soft key and then the **Rotary** soft key. The following menu items* appear.

* Source3(Z) can be set only for 4-channel models.

Count Conditions

Reset Condition
Displayed when Source3 (Z) is other than None

Set the count type to Rotary.

Level used to determine waveform state changes

Polarity

Hysteresis

Computation source waveform (When other than None)
► section 6.2*

When the computation source waveform is None

Computation source waveform (When None)
► section 6.2*

* Select None when not using Source3(Z).

Level used to determine waveform state changes

Computation source waveform ► section 6.2

Hysteresis

Level used to determine waveform state changes

Computation source waveform ► section 6.2

Hysteresis

6.5 Performing Count Computations

Count Conditions (Count Condition)

Press the **Count Condition** soft key. The following menu items appear.

When multiplication is set to x1

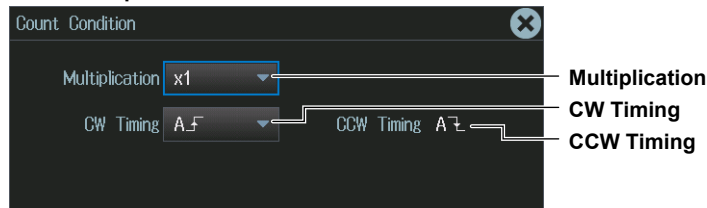

When multiplication is set to x2

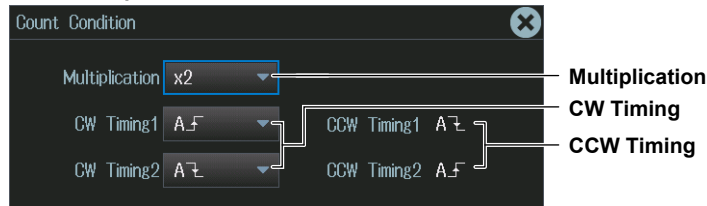

When multiplication is set to x4

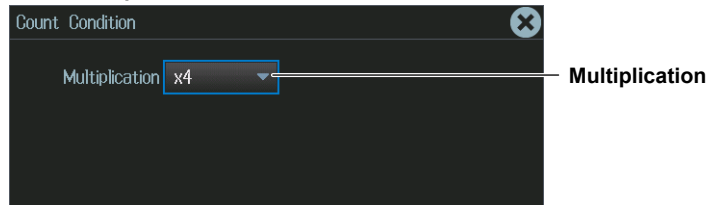

Reset Condition (Reset Condition)

Press the **Reset Condition** soft key. The following menu items appear.

When the reset condition is set to Z Only

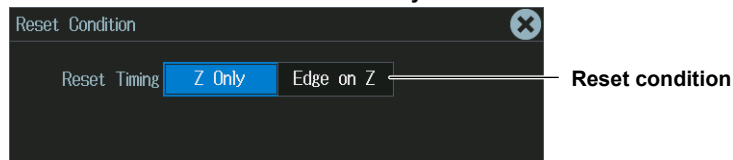

When the reset condition is set to Edge on Z

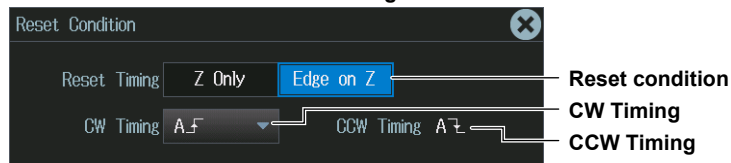

6.6 Setting Labels, Units, and Scaling

This section explains the following labels, units, and scaling settings:

- Labels and units
- Scaling

► “Setting Labels and Units (Label/Unit)” and “Scaling (Ranging)” in the Features Guide

MATH/REF Menu

1. Press **MATH/REF**. The MATH/REF menu appears.
You can also tap **MENU** (☰) in the upper left of the screen and select the MATH/REF menu from ANALYSIS on the top menu that is displayed.
2. Press the **Mode** soft key and then the **Math** soft key.
3. Press the **Operation** soft key and then the **User Define** soft key. The following menu items appear.

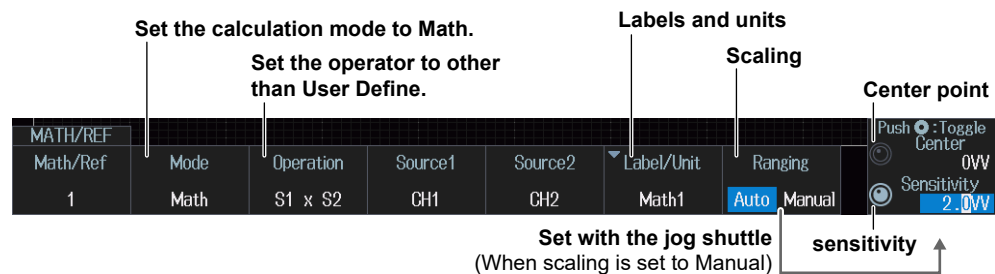

Labels and Units (Label/Unit)

Press the **Label/Unit** soft key. The following menu items appear.

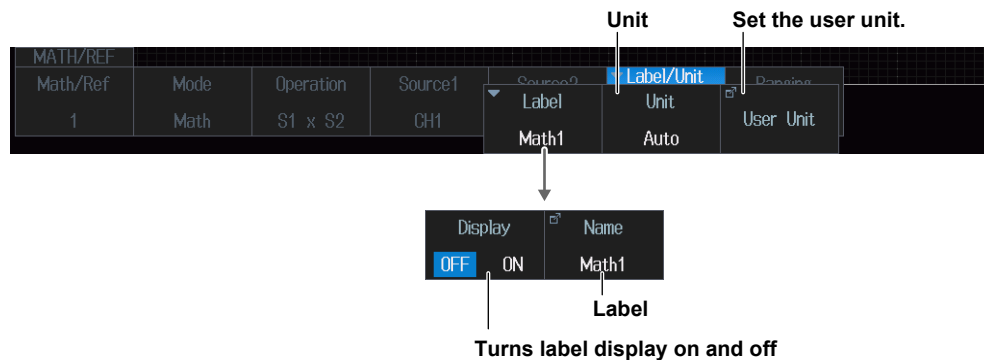

Scaling (Ranging)

Auto: Automatically set the vertical display range of the computed waveform.

Manual: Manually set the sensitivity (Sensitivity) and the signal level at the vertical center (Center).

6.7 Loading Reference Waveforms

This section explains the following settings for loading reference waveforms:

- Loading reference waveforms
- Reference waveform information display
- Label
- Vertical position

► [“Reference Waveforms” in the Features Guide](#)

MATH/REF Menu

1. Press **MATH/REF**. The MATH/REF menu appears.
 - You can also tap **MENU** (☰) in the upper left of the screen and select the MATH/REF menu from ANALYSIS on the top menu that is displayed.
 - Up to four reference waveforms can be displayed. To switch the setup menu, press the **Math/Ref** soft key.
2. Press the **Mode** soft key and then the **Ref** soft key. The following menu items appear.

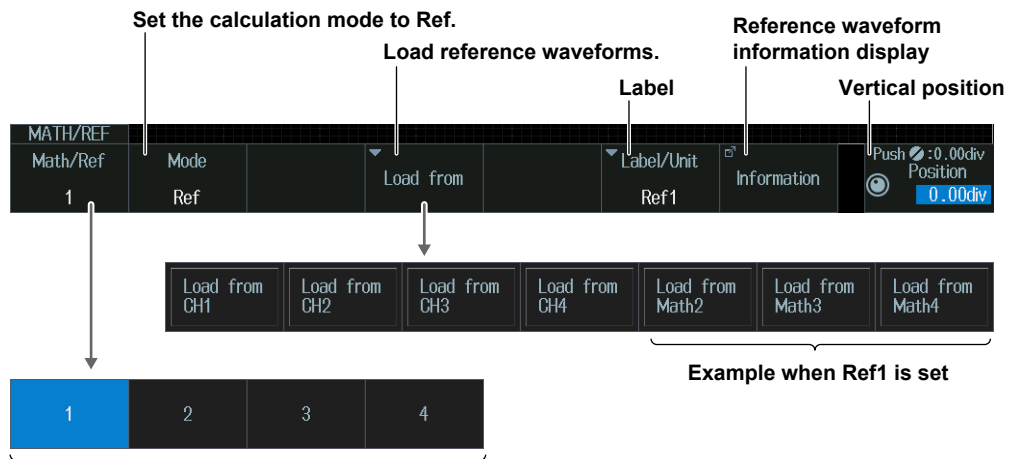

Select the reference waveform to be set from Ref1 to Ref4.*

* Ref3 and Ref4 can be set only for 4-channel models.

Loading the Reference Waveform (Load from)

The waveforms that can be set for the reference waveform are as follows.

Reference waveform	Load from*
Ref1 (Math/Ref1)	CH1 to CH4, Math2, Math3, and Math4
Ref2 (Math/Ref2)	CH1 to CH4, Math1, Math3, and Math4
Ref3 (Math/Ref3)	CH1 to CH4, Math1, Math2, and Math4
Ref4 (Math/Ref4)	CH1 to CH4, Math1, Math2, and Math3

* CH3, CH4, Math3, and Math4 can be set only for 4-channel models.

Labels (Label/Unit)

Press the **Label/Unit** soft key. The following menu items appear.

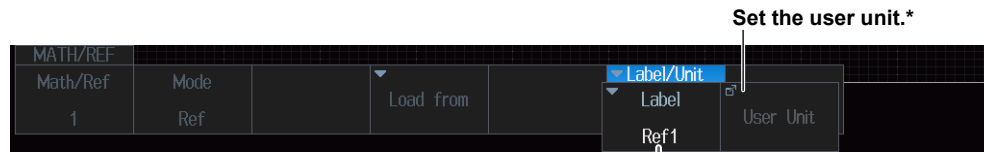

* You can set this when the calculation mode is Math.



Turns label display on and off

Reference Waveform Information Display (Information)

Press the **Information** soft key. Reference waveform information is displayed.

Display Example

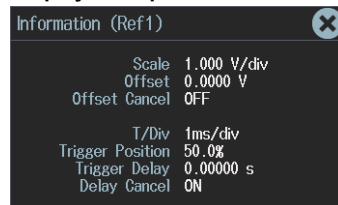

6.8 Performing User-Defined Computations (Optional)

This section explains the following settings for performing user-defined computations:

- Operators
- Expression
- Computation conditions
- Labels and units
- Execute automatic scaling

► “User-Defined Computation (User Define, option)” in the Features Guide

MATH/REF Menu

1. Press **MATH/REF**. The MATH/REF menu appears.
 - You can also tap **MENU** (☰) in the upper left of the screen and select the MATH/REF menu from ANALYSIS on the top menu that is displayed.
 - Up to four computed waveforms can be displayed. To switch the setup menu, press the **Math/Ref** soft key.
2. Press the **Mode** soft key and then the **Math** soft key.
3. Press the **Operation** soft key and then the **User Define** soft key. The following menu items appear.

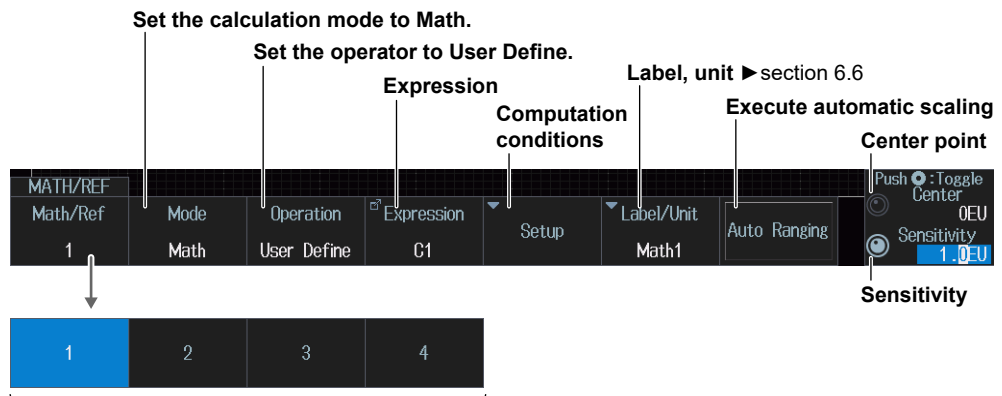

Specify the computed waveform from among Math1 to Math4.*

* Math3 and Math4 can be set only for 4-channel models.

Expression (Expression)

Press the **Expression** soft key. The following screen appears.

Example: Computed waveform Math4

Define an expression by combining computation source waveforms and operators
 Add the results of automated measurement of waveform parameters to the expression.

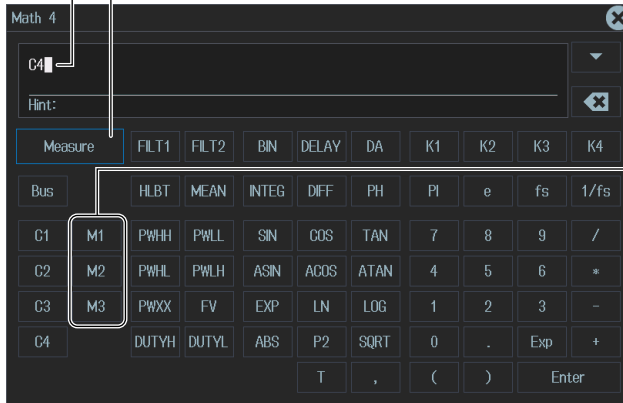

- Computed waveform Math3
M1
M2
- Computed waveform Math2
M1
- M1 to M3 are not displayed for computed waveform Math1.

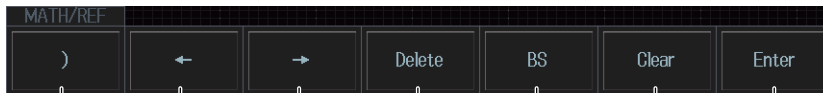

- Inserts a)
- Moves the cursor to the left
- Moves the cursor to the right
- Deletes the character at the cursor position
- Deletes the previous character
- Deletes all the characters you have entered
- Enters the expression

Computation Conditions (Setup)

Press the **Setup** soft key. The following menu items appear.

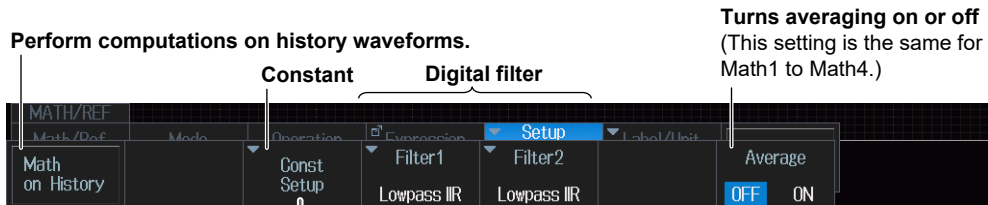

Turns averaging on or off
 (This setting is the same for Math1 to Math4.)

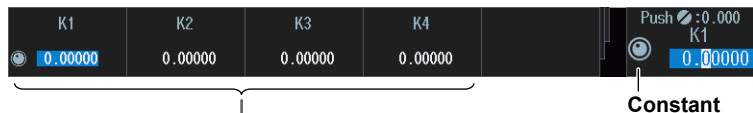
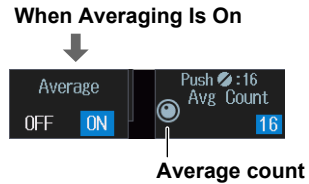

Set each with the jog shuttle

6.8 Performing User-Defined Computations (Option)

Digital filters(Filter1, Filter2)

Press the **Filter1** soft key and then the **Filter2** soft key. The following menu items appear.

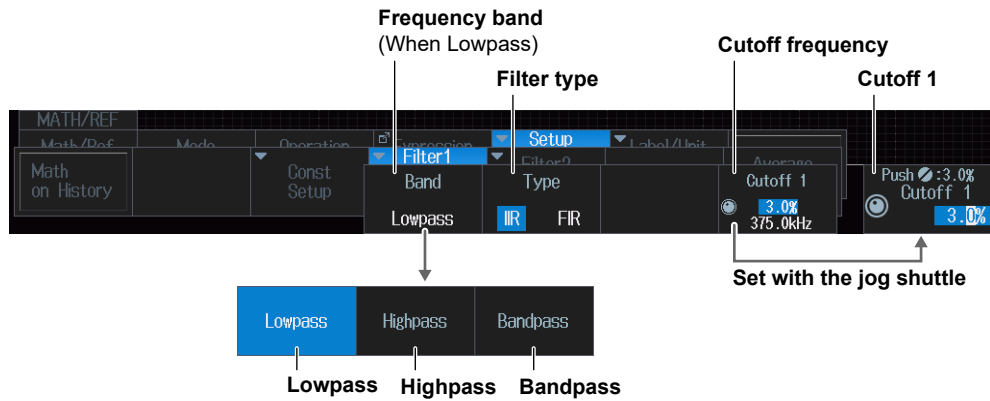

When Frequency Band Is Set to Highpass

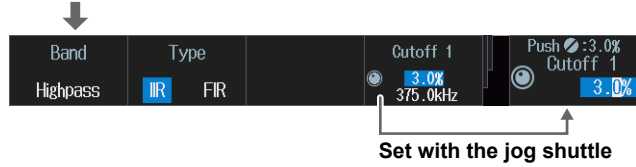

When Frequency Band Is Set to Bandpass

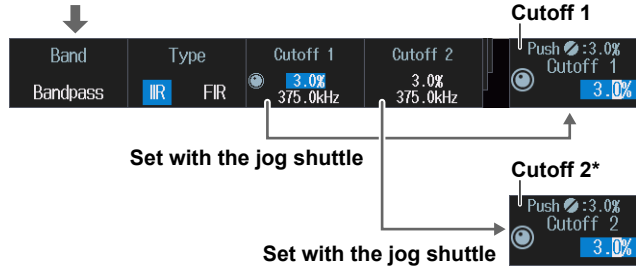

* Cutoff2 is only applicable when the frequency band is set to Bandpass.

7.1 Displaying FFT Waveforms

This section explains the following settings for performing FFT analysis:

- Turning FFT waveform display on or off
- Analysis source waveform
- FFT conditions
- Analysis range
- Vertical and horizontal scale values
- FFT points

► “FFT” in the Features Guide

FFT Menu

Press **SHIFT+MATH/REF** (FFT). The following menu items appear.

- You can also tap **MENU** (MENU) in the upper left of the screen and select the FFT menu from ANALYSIS on the top menu that is displayed.
- Up to two FFT waveforms can be displayed. To switch the setup menu, press the **FFT** soft key.

Select whether to set FFT1 or FFT2.*

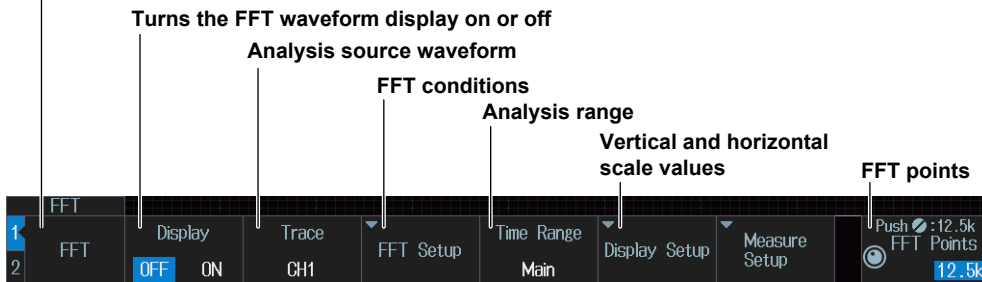

* FFT2 can be set only for 4-channel models.

FFT Conditions (FFT Setup)

Press the **FFT Setup** soft key. The following menu items appear.

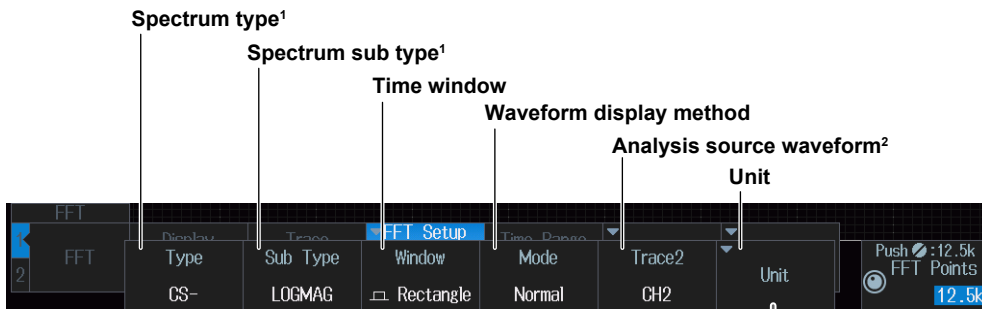

1 This is available on models with the user-defined computation option.

2 Can only be set when Type is CS-, TF-, or CH-.

3 This is available only when Type is set to PS-, Sub Type is set to LOGMAG, and the unit of the analysis source waveform (Trace) is “V.”

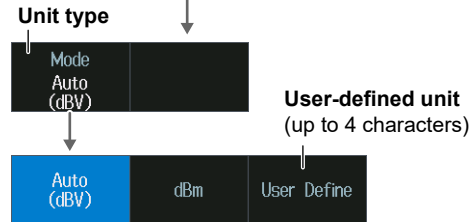

When the unit type is dBm³



7.1 Displaying FFT Waveforms

Spectrum Type (Type/Sub Type)

Depending on the type, the following sub types can be set.

Type	Sub Type
LS-, CS-, TF-	MAG, LOGMAG, PHASE, REAL, IMAG
RS-, PS-, SPD-	MAG, LOGMAG
CH-	MAG

Vertical and Horizontal Scale Values (Display Setup)

Press the **Display Setup** soft key. The following menu items appear.

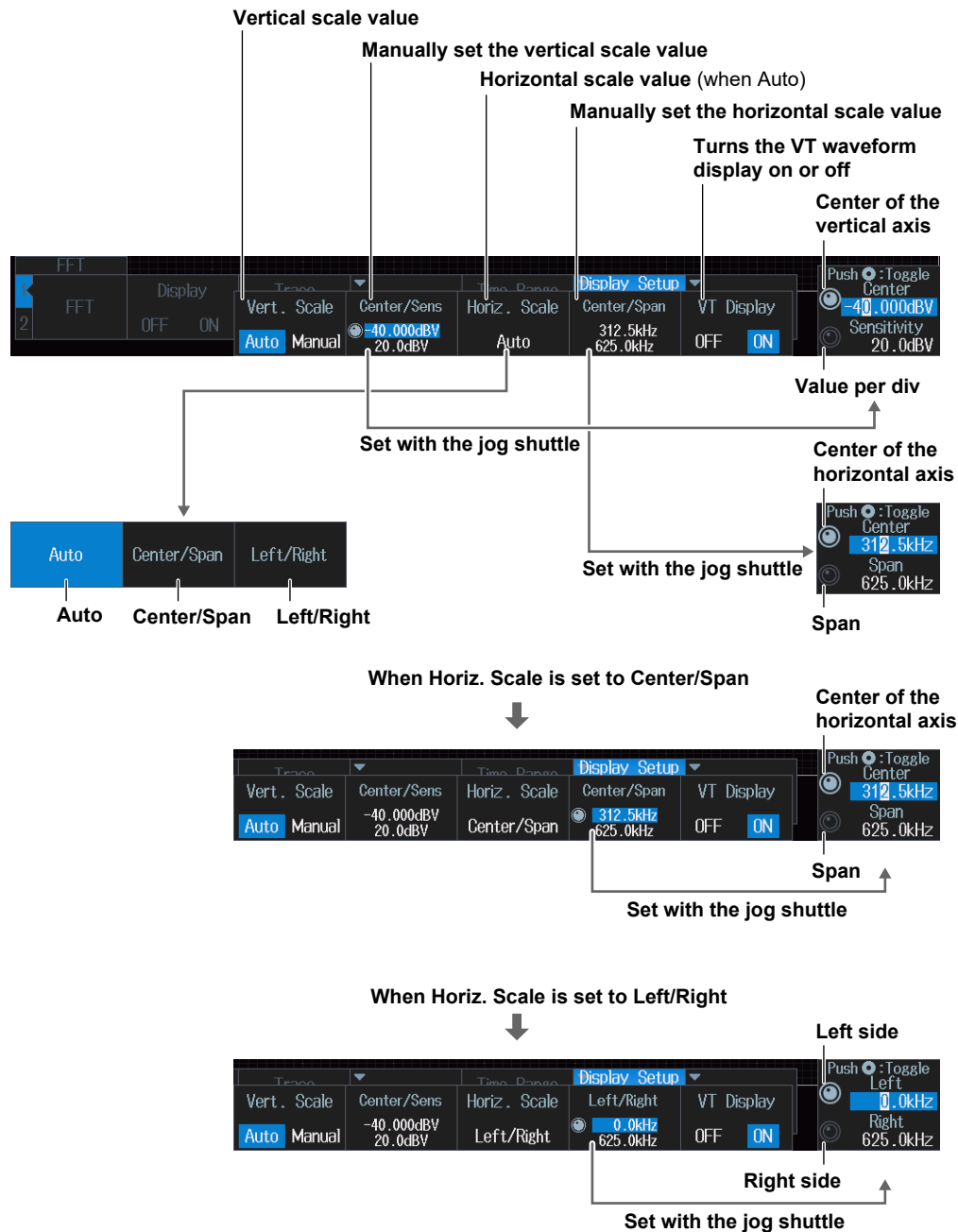

7.2 Measuring FFT Waveforms

This section explains the following settings for measuring FFT waveforms:

- Measurement mode
- Marker cursor measurement
- Peak cursor measurement
- Parameter measurement

► “Measurement (Measure Setup)” in the Features Guide

FFT Measure Setup Menu

1. Press **SHIFT+MATH/REF** (FFT). The FFT menu item appears.
You can also tap **MENU** (☰) in the upper left of the screen and select the FFT menu from ANALYSIS on the top menu that is displayed.
2. Press the **Measure Setup** soft key. The following menu items appear.

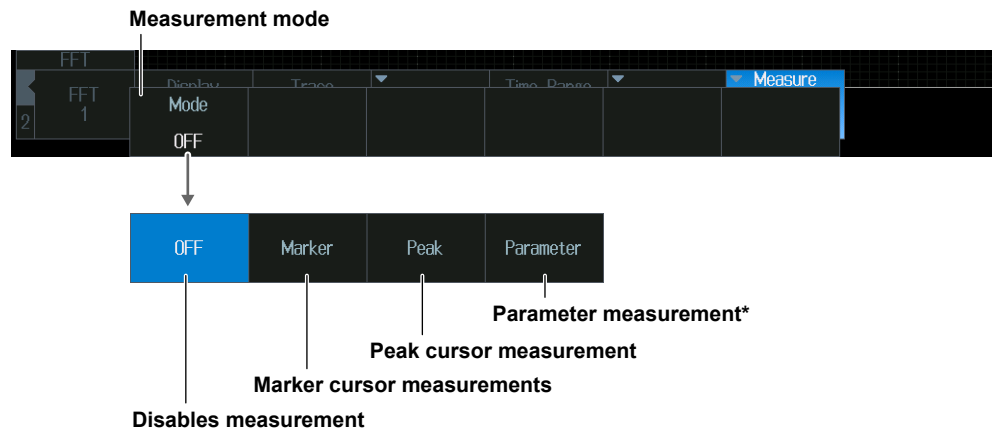

* Can only be set when the spectrum is set to PS-MAG, PS-LOGMAG, PSD-MAG, or PSD-LOGMAG.

Marker Cursor Measurement (Marker)

Press the **Mode** soft key and then the **Marker** soft key. The following menu items appear.

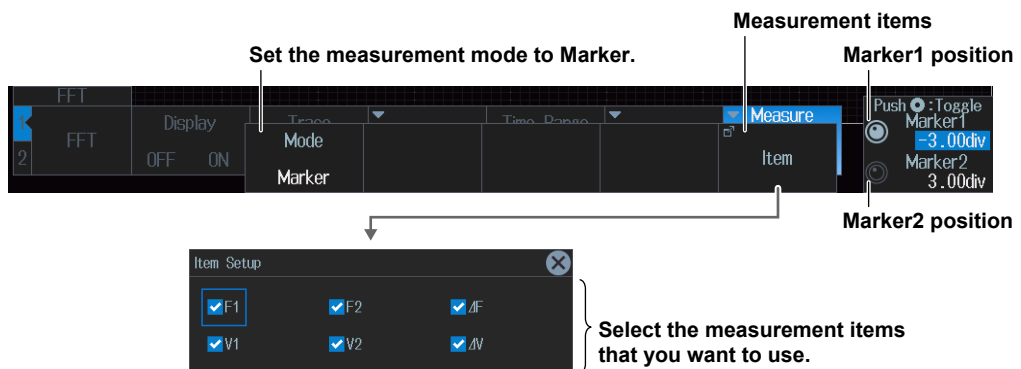

Peak Cursor Measurement (Peak)

Press the **Mode** soft key and then the **Peak** soft key. The following menu items appear.

Set the measurement mode to Peak.

Threshold value

Difference between peak and valley

Measurement frequency range

List display

list number

Set with the jog shuttle

Set with the jog shuttle

Set with the jog shuttle

Set with the jog shuttle

No.	Frequency	Peak
1	0.000000 Hz	0.000000 Hz
2	500.000000kHz	-3.43643 dBV
3	7.500000MHz	-895.714m dBV
4	12.500000MHz	-14.6118 dBV
5	17.500000MHz	-19.3645 dBV
6	22.500000MHz	-22.7194 dBV
7	27.500000MHz	-25.2132 dBV
8	32.500000MHz	-27.1590 dBV
9	37.500000MHz	-29.8498 dBV
10	42.500000MHz	-30.5867 dBV

Maximum peak display

Jump To Max Peak

Parameter Measurement (Parameter)

Press the **Mode** soft key and then the **Parameter** soft key. The following menu items appear.

Set the measurement mode to Parameter.

Turns the overall value on and off

8.1 Measuring with ΔT Cursors

This section explains the following settings for measuring with ΔT cursors:

- Turning cursor measurement on or off
- Cursor type
- Source waveform
- Measurement items
- Cursor jumping
- Cursor position

► “ ΔT Cursors (ΔT)” in the Features Guide

CURSOR Menu

1. Press **CURSOR**. The CURSOR menu appears.
You can also tap **MENU** (☰) in the upper left of the screen and select the CURSOR menu from MEASURE on the top menu that is displayed.
2. Press the **Type** soft key and then the **ΔT** soft key. The following menu items appear.

Turns cursor measurement on or off
Set the cursor type to ΔT .
Measurement source waveform*
Measurement items
Cursor jumping
Cursor1 position
Cursor2 position

Item Setup

All ON		All OFF	
<input checked="" type="checkbox"/> T1	<input checked="" type="checkbox"/> T2	<input checked="" type="checkbox"/> ΔT	<input checked="" type="checkbox"/> 1/ ΔT
<input checked="" type="checkbox"/> V1	<input checked="" type="checkbox"/> V2	<input checked="" type="checkbox"/> ΔV	<input checked="" type="checkbox"/> $\Delta V/\Delta T$

Select the measurement items that you want to use.

* CH4 or LOGIC, whichever the corresponding key is illuminated, can be selected. Specify the channel that you want to measure in advance by pressing either the CH4 key or the LOGIC key.

Cursor Jumping (Cursor Jump)

Press the **Cursor Jump** soft key. The following menu items appear.

Specify a zoom window to make Cursor1 or Cursor2 jump to.

Note

Setting the Cursor Positions

You can move Cursor1 and Cursor2 together by pressing SET repeatedly until the jog shuttle adjusts both of them.

When the cursors are linked, if either Cursor1 or Cursor2 moves to the edge of the screen, it cannot move any further. Therefore, if you execute cursor jump with the cursors linked, proper cursor jumping may not be achieved.

8.2 Measuring with ΔV cursors

This section explains the following settings used for measurement with ΔV cursors:

- Turning cursor measurement on or off
- Cursor type
- Source waveform
- Measurement items
- Cursor position

► “ ΔV Cursors (ΔV)” in the Features Guide

CURSOR Menu

1. Press **CURSOR**. The CURSOR menu appears.

You can also tap **MENU** (☰) in the upper left of the screen and select the CURSOR menu from MEASURE on the top menu that is displayed.

2. Press the **Type** soft key and then the ΔV soft key. The following menu items appear.

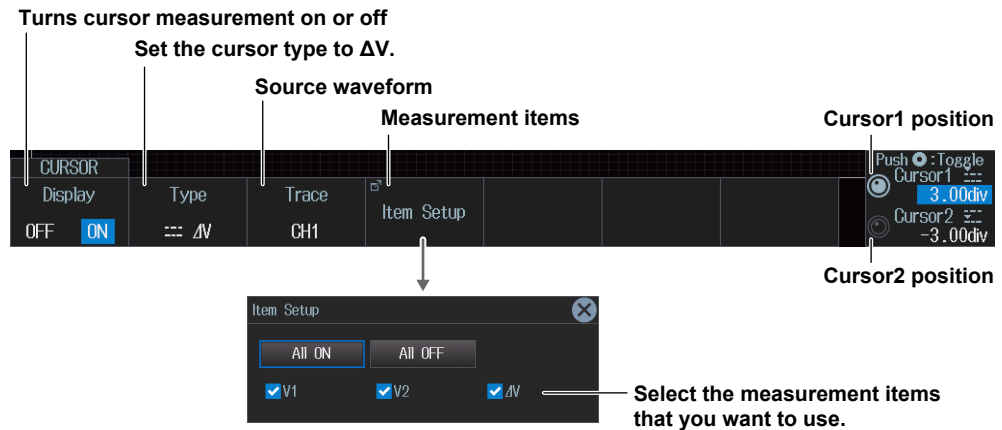

Note

Setting the Cursor Positions

You can move Cursor1 and Cursor2 together by pressing SET repeatedly until the jog shuttle adjusts both of them.

When the cursors are linked, if either Cursor1 or Cursor2 moves to the edge of the screen, it cannot move any further.

8.3 Measuring with ΔT and ΔV Cursors

This section explains the following settings for measuring with ΔT and ΔV cursors:

- Turning cursor measurement on or off
- Cursor type
- Source waveform
- Measurement items
- ΔT cursor jumping
- Cursor position

► “ ΔT & ΔV Cursors (ΔT & ΔV)” in the Features Guide

CURSOR Menu

1. Press **CURSOR**. The CURSOR menu appears.
You can also tap **MENU** (☰) in the upper left of the screen and select the CURSOR menu from MEASURE on the top menu that is displayed.
2. Press the **Type** soft key and then the **ΔT & ΔV** soft key. The following menu items appear.

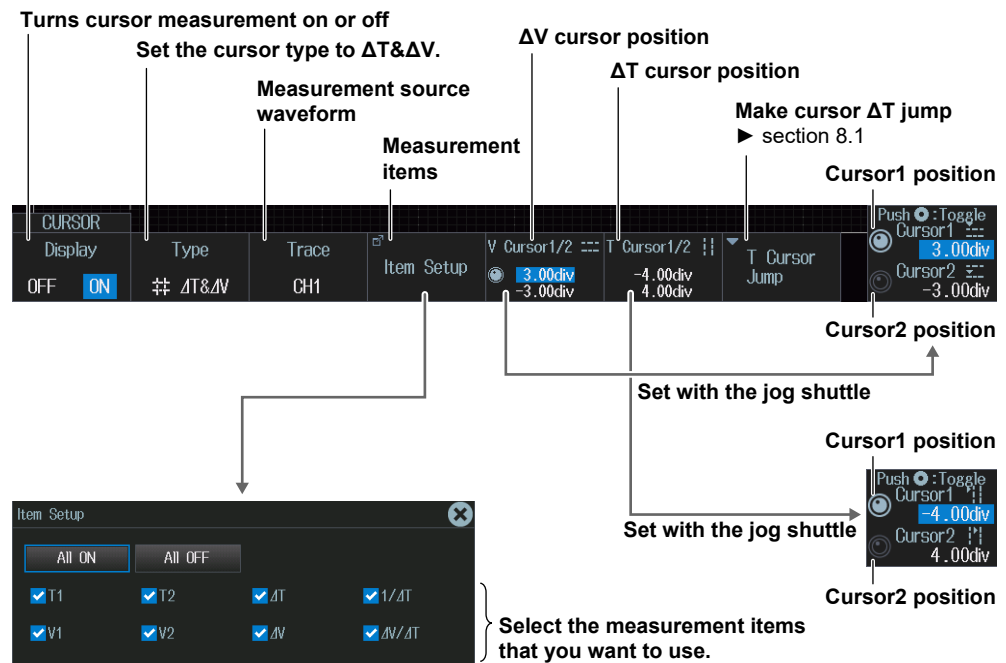

Note

Setting the Cursor Positions

You can move Cursor1 and Cursor2 together by pressing SET repeatedly until the jog shuttle adjusts both of them.

When the cursors are linked, if either Cursor1 or Cursor2 moves to the edge of the screen, it cannot move any further. Therefore, if you execute cursor jump with the cursors linked, proper ΔT cursor jumping may not be achieved.

8.4 Measuring with Marker Cursors (Marker)

This section explains the following settings for measuring with marker cursors:

- Turning cursor measurement on or off
- Cursor type
- Marker display format
- The waveform to measure using the cursors
- Measurement items
- Cursor jumping
- Cursor position

► “Marker Cursors (Marker)” in the Features Guide

CURSOR Menu

1. Press **CURSOR**. The CURSOR menu appears.
You can also tap **MENU** (E) in the upper left of the screen and select the CURSOR menu from MEASURE on the top menu that is displayed.
2. Press the **Type** soft key and then the **Marker** soft key. The following menu items appear.

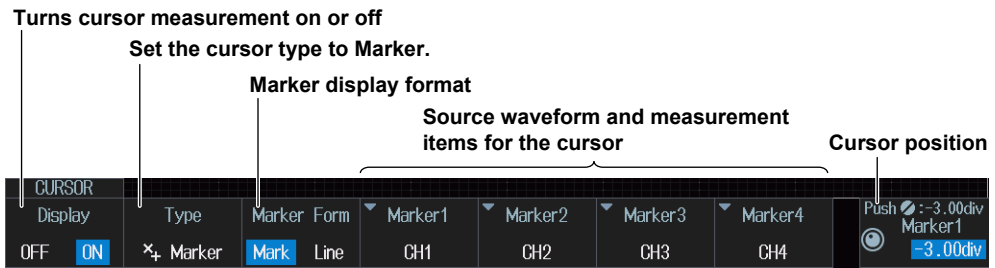

Cursor Source Waveform and Measurement Items (Marker1, Marker2, Marker3, and Marker4)

Press one of the **Marker1** to **Marker4** soft keys. The following menu items appear.

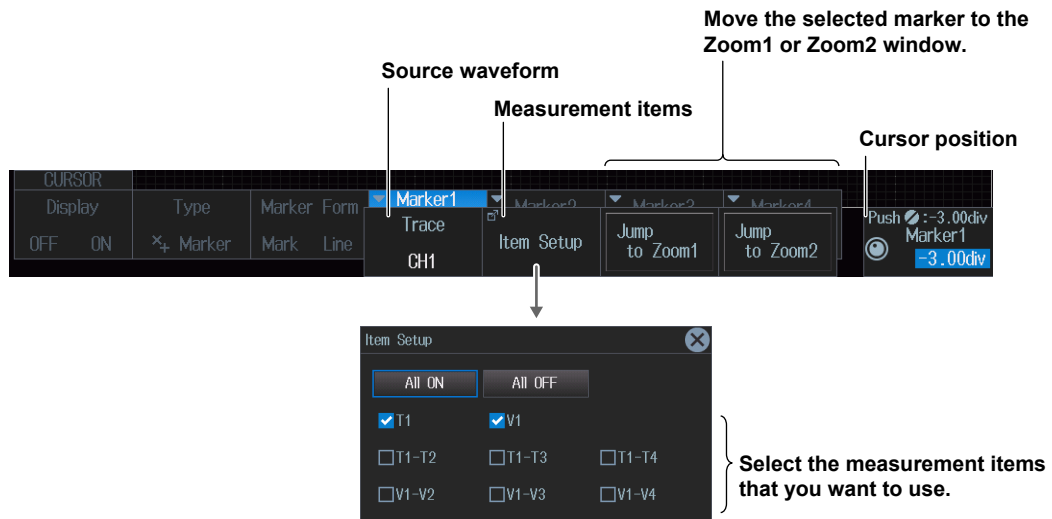

8.5 Measuring with Angle Cursors (Degree)

This section explains the following settings for measuring with angle cursors:

- Turning cursor measurement on or off
- Cursor type
- Source waveform
- Measurement items
- Reference setup
- Cursor jumping
- Cursor position

► “Angle Cursors (Degree)” in the Features Guide

CURSOR Menu

1. Press **CURSOR**. The CURSOR menu appears.
You can also tap **MENU** (☰) in the upper left of the screen and select the CURSOR menu from MEASURE on the top menu that is displayed.
2. Press the **Type** soft key and then the **Degree** soft key. The following menu items appear.

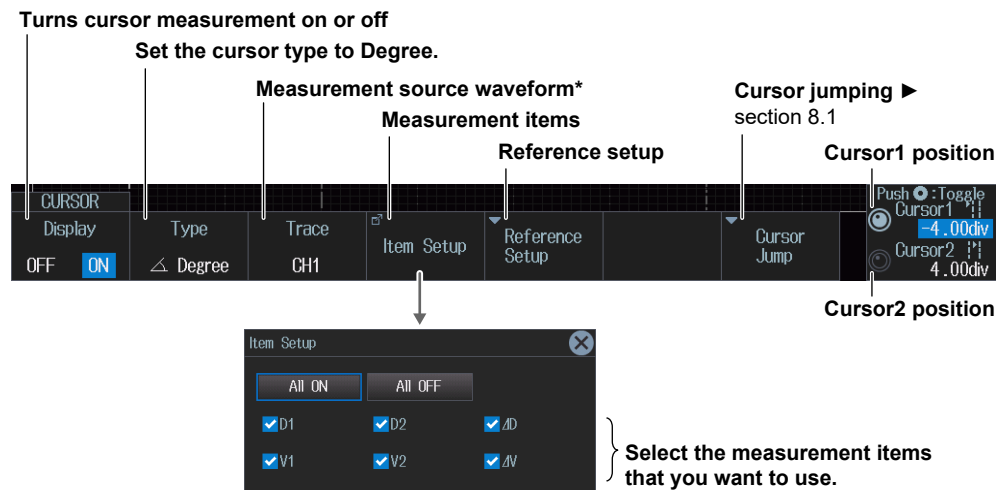

- * CH4 or LOGIC, whichever the corresponding key is illuminated, can be selected. Specify the channel that you want to measure in advance by pressing either the CH4 key or the LOGIC key.

Note

Setting the Cursor Positions

You can move Cursor1 and Cursor2 together by pressing SET repeatedly until the jog shuttle adjusts both of them.

When the cursors are linked, if either Cursor1 or Cursor2 moves to the edge of the screen, it cannot move any further. Therefore, if you execute cursor jump with the cursors linked, proper cursor jumping may not be achieved.

Setting the Reference (Reference Setup)

Press the **Reference Setup** soft key. The following menu items appear.

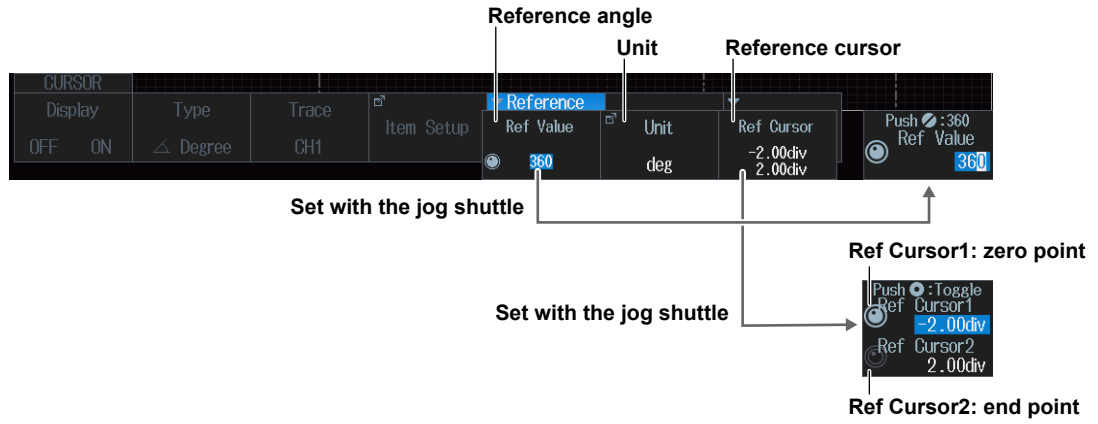

9.1 Automatically Measuring Waveform Parameters

This section explains the following settings for automatically measuring waveform parameters:

- Turning automated measurement on or off
- Measurement source waveform and measurement items
- The measurement location indicator
- Reference levels for automated measurements
- Measurement source window
- Measurement range

▶ [“Automated Measurement of Waveform Parameters” in the Features Guide](#)

MEASURE Menu

Press **MEASURE**. The following menu items appear.

You can also tap **MENU** (ⓘ) in the upper left of the screen and select the MEASURE menu from MEASURE on the top menu that is displayed.

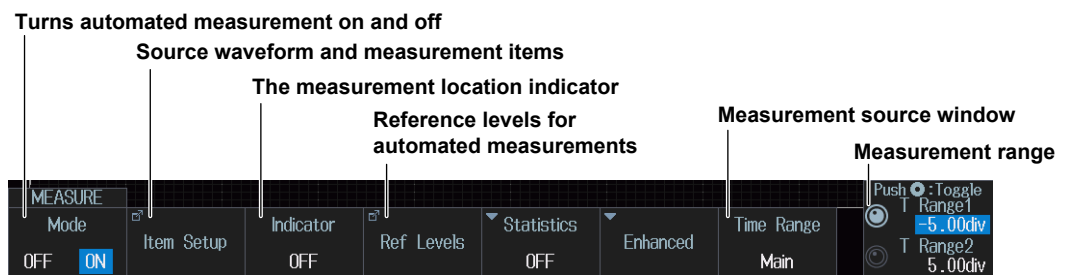

Measurement Source Waveform and Measurement Items (Item Setup)

1. Press the **Item Setup** soft key.
2. Press the **Source** soft key. Select the source waveform from the setup menu that is displayed. A menu appears according to the waveform to be measured you specified.

When the Measurement Source Waveform Is CH1 to CH4 or Math1 to Math4

Clear the check boxes of all the measurement items.
Copy the settings on this screen to all channels.

Cycle mode

Select the measurement items that you want to use.

Measurement of delay between waveforms

Set to one of CH1 to CH4* or one of Math1 to Math4

* CH4 or LOGIC, whichever the corresponding key is illuminated, can be selected. Specify the channel that you want to measure in advance by pressing either the CH4 key or the LOGIC key.

Slope of the edge to be detected

Which counted edge to use as a detected point

Reference (when Trigger Position)

Unit

When the reference is other than Trigger Position

References

Note

About Cycle Mode

- When the power analysis type is switching loss, the cycle mode waveform parameter is fixed to SW Loss.
- When power measurement is ON, the cycle mode waveform parameter changes according to the setting of the cycle mode of power measurement.

When the Source Waveform Is LOGIC (On models with the logic signal input port)

Clear the check boxes of all the measurement items.



Select the measurement items that you want to use.

Measurement of delay between waveforms

Set the measurement source waveform to LOGIC.*

* CH4 or LOGIC, whichever the corresponding key is illuminated, can be selected. Specify the channel that you want to measure in advance by pressing either the CH4 key or the LOGIC key.

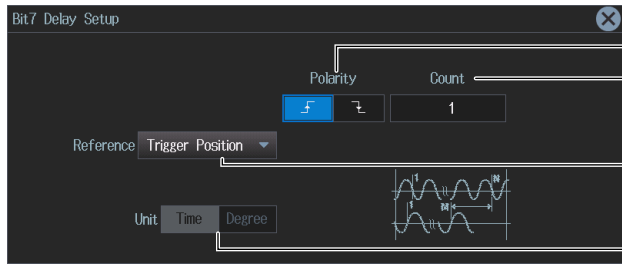

Slope of the edge to be detected
Which counted edge to use as a detected point

Reference (when Trigger Position)

Unit

When Reference is set to LOGIC

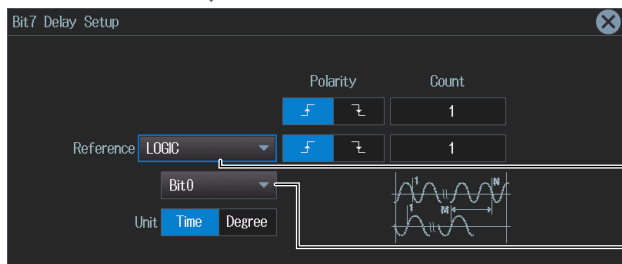

References

Source bit

When the reference is other than Trigger Position/LOGIC

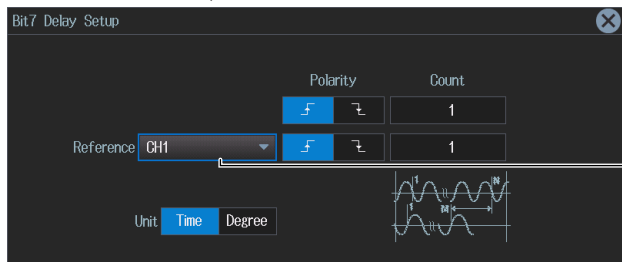

References

Measurement Location Indicator (Indicator)

1. Press the **Indicator** soft key.

You can set Indicator to OFF (the measurement location indicator is not displayed) or display a setup menu with the items whose check boxes you have selected in "Measurement Source Waveform and Measurement Items (Item Setup)."

* The measurement locations of the following items can be indicated.

Max, Min, P-P, High, Low, Amplitude, Rms, Mean, Sdev(AC RMS), +Over, -Over, V1, V2, IntegTY+, IntegTY, Freq, Period, Avg Freq, Avg Period, Burst, Rise, Fall, +Width, -Width, Duty, Delay

2. Use the **jog shuttle** or the **SET** key to select the item whose measurement location you want to indicate.
3. Press **SET** to confirm.
The measurement location of the item you specify is indicated by a cursor.

Reference Levels for Auto Measurements (Ref Levels)

Press the **Ref Levels** soft key. The following menu items appear.

Reference level setting unit

	Mode	Distal value	Mesial value	Proximal value	High/Low level
Ref Levels	%	90%	50%	10%	Auto
CH1	% Unit	90%	50%	10%	Auto
CH2	% Unit	90%	50%	10%	Auto
CH3	% Unit	90%	50%	10%	Auto
CH4	% Unit	90%	50%	10%	Auto
Math1	% Unit	90%	50%	10%	Auto
Math2	% Unit	90%	50%	10%	Auto
Math3	% Unit	90%	50%	10%	Auto
Math4	% Unit	90%	50%	10%	Auto

Source Window (Time Range)

Main : Set the measurement source window to the Main window.

Zoom1 : Set the measurement source window to the Zoom1 window.

Zoom2 : Set the measurement source window to the Zoom2 window.

Measurement Range (T Range1/T Range2)

Set the measurement time period within the window specified by Time Range.

Note

About the roll-mode display

- The instrument will not display computed waveforms (MATH waveforms) that have been generated through user-defined computation while it is acquiring waveforms in roll mode. The instrument will display the computed waveforms after it stops acquiring waveforms.
- If normal statistical processing (Continuous), serial bus analysis, waveform histogram display, or harmonic analysis is being executed, automatically measured parameter values are not displayed when waveforms are being acquired in roll mode. Measured values are shown when a trigger occurs and the roll mode display stops.
- If the record length is set such that waveform acquisition operates in single mode,* neither computed waveforms (MATH waveforms) nor automated measurement values of waveform parameters are shown while waveform acquisition in roll mode is in progress. The instrument will display the computed waveforms and automated measurement values after it stops acquiring waveforms.

* The record length that causes waveform acquisition to operate in single mode varies depending on whether a memory expansion option (/M1, /M2) is available. For details, see chapter 6, "Waveform Acquisition," in the *Features Guide* (IM DLM3054-01EN).

9.2 Processing Statistics on Automatically Measured Values

This section explains the following settings for processing statistics on automatically measured waveform parameters:

- Statistical processing mode
- Normal statistical processing
- Cyclic statistical processing
- Statistical processing of history waveforms

► [“Statistics \(Statistics\)” in the Features Guide](#)

MEASURE Statistics Menu

1. Press **MEASURE**. The MEASURE menu appears.
You can also tap **MENU** (☰) in the upper left of the screen and select the MEASURE menu from MEASURE on the top menu that is displayed.
2. Press the **Statistics** soft key. The following menu items appear.

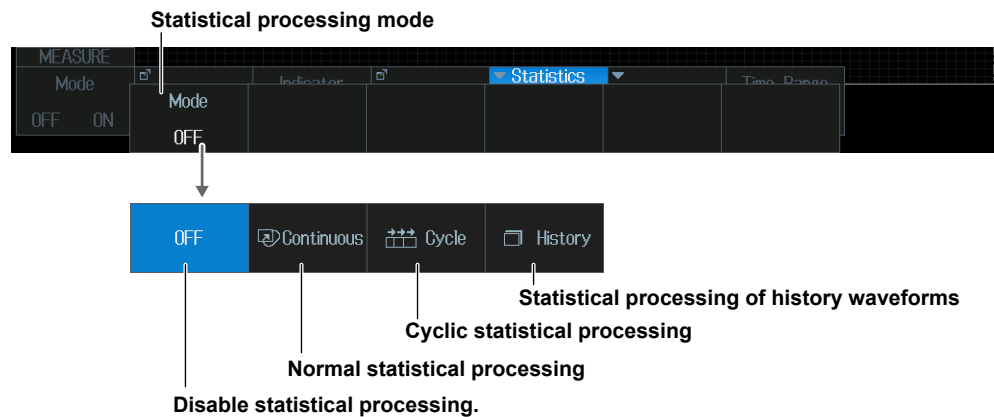

Note

If you change the statistical processing type (Statistics), the statistical processing type (Statistics) of Measure Setup for power measurement (Power Measurement menu) also changes in sync.

Normal Statistical Processing (Continuous)

Press the **Mode** soft key and then the **Continuous** soft key. The following menu items appear.

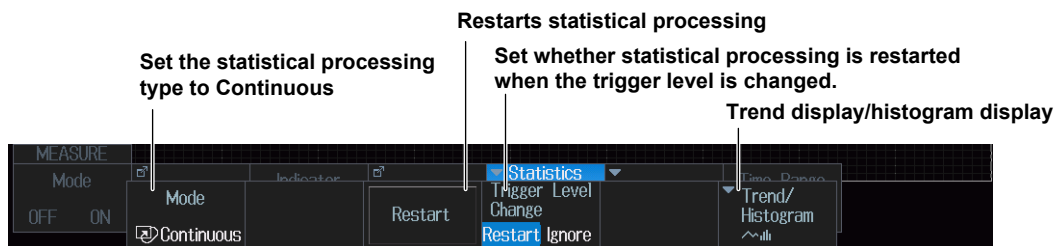

Set whether statistical processing is restarted when the trigger level is changed.

Restart: If the trigger level is changed during waveform acquisition, the statistical processing performed up to that point is discarded, the waveform Count is set to 1, and statistical processing restarts.

Ignore: If the trigger level is changed during waveform acquisition, waveform acquisition and statistical processing continue without statistical processing being reset.

Setting the Trend Display and the Histogram Display (Trend/Histogram)

Press the **Trend/Histogram** soft key.

Trend display

Press the **Mode** soft key and then the **Trend** soft key. The following menu items appear.

- Up to two trends can be displayed. To switch the setup menu, press the **Trend/Histogram** soft key.

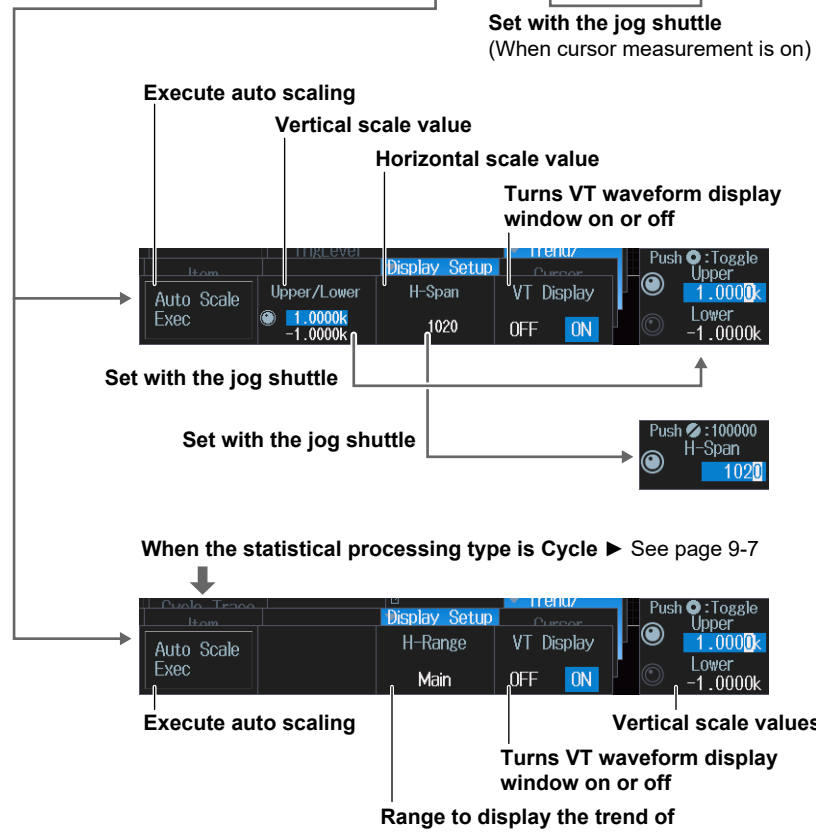
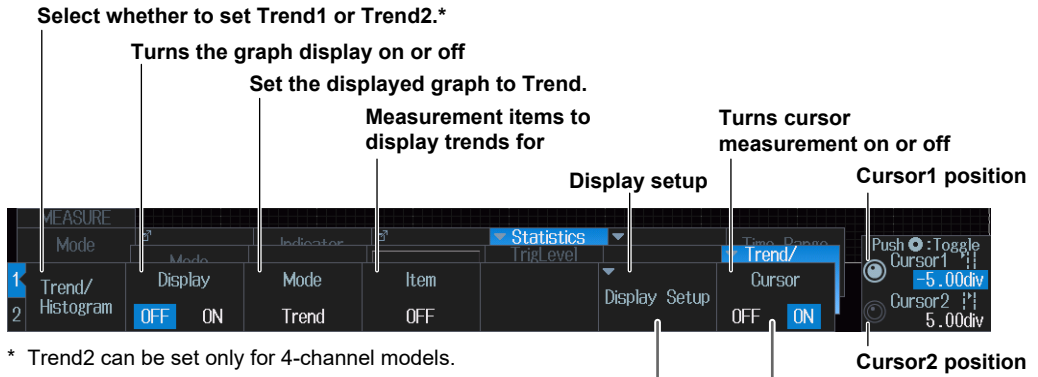

Histogram display

Press the **Mode** soft key and then the **Histogram** soft key. The following menu items appear.

- Up to two histograms can be displayed. To switch the setup menu, press the **Trend/Histogram** soft key.

Select whether to set Histogram1 or Histogram2.*

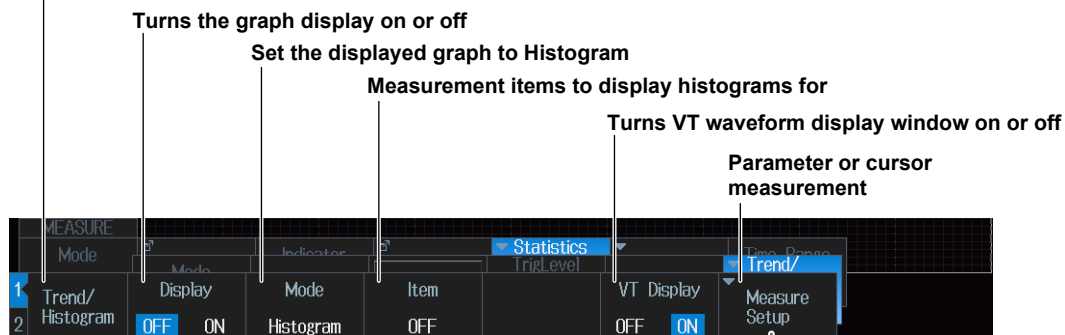

* Histogram2 can be set only for 4-channel models.

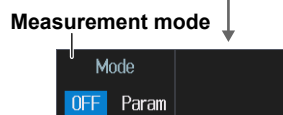

When the measurement mode is Param

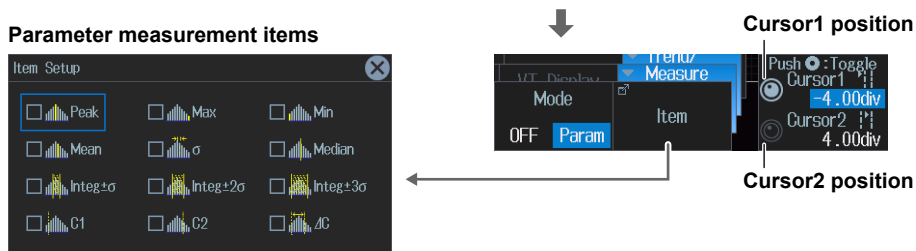

Select the measurement items that you want to use.

Cyclic Statistical Processing (Cycle)

Press the **Mode** soft key and then the **Cycle** soft key. The following menu items appear.

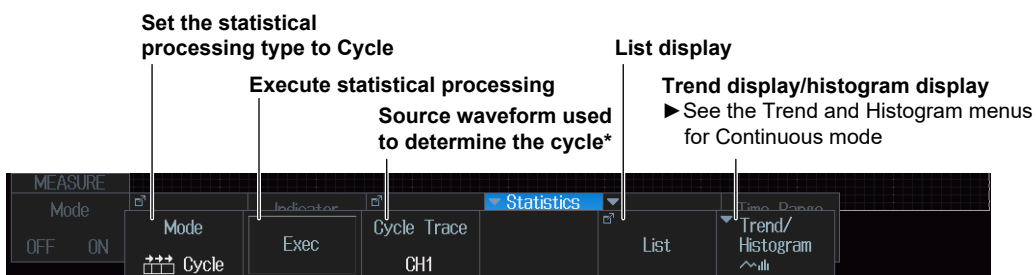

* CH4 or LOGIC, whichever the corresponding key is illuminated, can be selected. Specify the channel that you want to measure in advance by pressing either the CH4 key or the LOGIC key.

When the source waveform used to determine the cycle is LOGIC

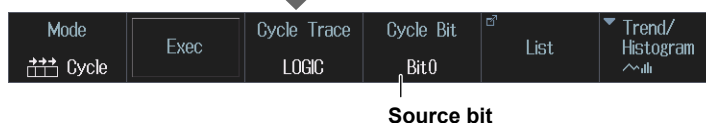

9.2 Processing Statistics on Automatically Measured Values

List Display (List)

Press the **List** soft key. The following menu items appear.

Highlight display

↓: Displayed next to the minimum value of each measurement item.

↑: Displayed next to the maximum value of each measurement item.

Measure	Statistics					
	P-P(C1)	High(C1)	Low(C1)	Amplitude(C1)	Rms(C1)	Mean(C1)
1	3.82 V	3.45 V	-0.09 V↑	3.54 V↓	1.54247 V	607.572mV↓
2	3.85 V	3.45 V	-0.09 V↑	3.54 V↓	1.54288 V	612.346mV
3	3.88 V	3.45 V↑	-0.09 V↑	3.54 V	1.54143	611.566mV
4	3.88 V	3.45 V↑	-0.09 V↑	3.54 V	1.54554 V	610.522mV
5	3.93 V	3.45 V	-0.09 V↑	3.54 V↓	1.54272 V	613.995mV
6	3.85 V	3.45 V	-0.09 V↑	3.54 V↓	1.54318 V	612.587mV
7	3.84 V	3.45 V	-0.10 V	3.54 V	2.18049 V	1.32075 V
8	3.83 V	3.45 V↑	-0.09 V↑	3.54 V	2.41492 V	1.67484 V
9	3.91 V	3.43 V↓	-0.12 V↓	3.55 V	3.12941	2.84002 V↑
10	3.90 V	3.45 V	-0.10 V	3.55 V	1.70584 V	773.668mV

When a scroll bar appears, you can move the SET key left and right or up and down to move the highlighted position and scroll through the displayed items.

Search mode **Select the sort method** **Zoom link** **List size and display position**

Search Mode	Jump To	Sort	Zoom Link	List Size
OFF		Forward	Zoom1	Half(Upper)

When the search mode is other than OFF

Statistics Max	Statistics Min	Oldest	Latest
----------------	----------------	--------	--------

When the search mode is other than OFF

Previous	Next	Oldest	Latest
----------	------	--------	--------

Jumps to and highlights the specified destination

Note

If you move the highlight display for the measured values up and down, you will zoom in to the corresponding position of the waveform.

Search Mode (Search Mode)

1. Press the **Search Mode** soft key. The following menu items appear.
If you select "Data ≤ b", "a ≤ Data" or "a ≤ Data ≤ b", set the value of a or b with the jog shuttle.

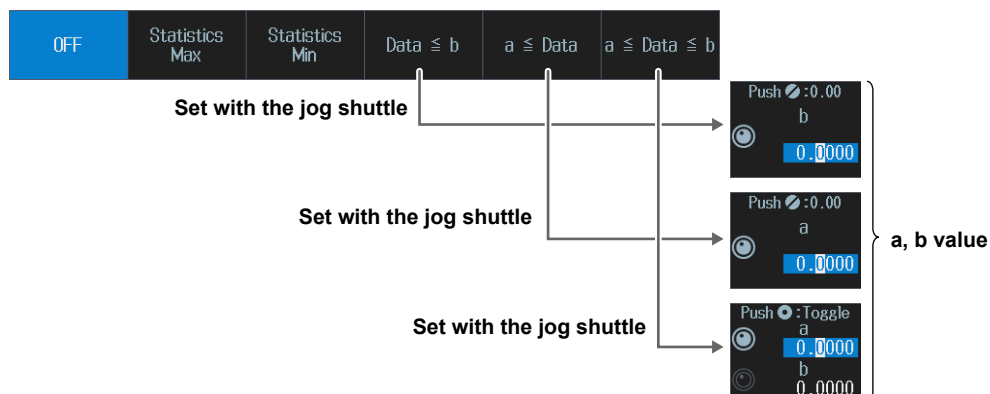

2. Select the search item, and then press **ESC**.
The List display menu is returned to.

When the search mode is Data ≤ b

Search Mode	b	Jump To	Sort	Zoom Link	List Size
Data ≤ b	0.0000		Forward	Zoom1	Half(Upper)

Display of b value

When the search mode is a ≤ Data

Search Mode	a	Jump To	Sort	Zoom Link	List Size
a ≤ Data	0.0000		Forward	Zoom1	Half(Upper)

Display of a value

When the search mode is a ≤ Data ≤ b

Search Mode	a/b	Jump To	Sort	Zoom Link	List Size
a ≤ Data ≤ b	0.0000 0.0000		Forward	Zoom1	Half(Upper)

Display of a/b value

Statistical Processing of History Waveforms (History)

Press the **Mode** soft key and then the **History** soft key. The following menu items appear.

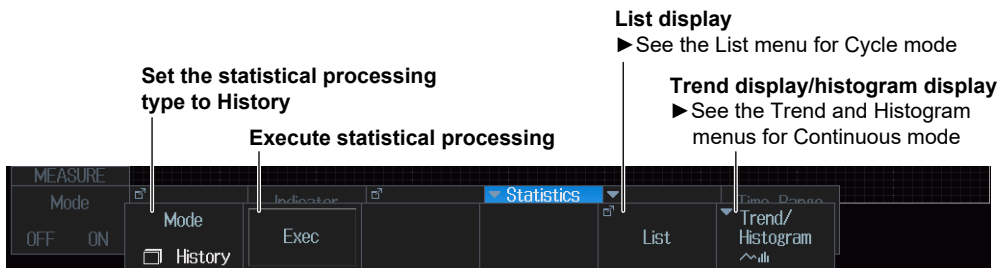

9.3 Measuring Enhanced Parameters

This section explains the settings used when performing automated measurement of the waveform parameters of two areas and the settings used when performing calculations using waveform parameters.

► “Enhanced Parameter Measurement (Enhanced)” in the Features Guide

MEASURE Enhanced Menu

1. Press **MEASURE**. The MEASURE menu appears.
You can also tap **MENU** () in the upper left of the screen and select the MEASURE menu from MEASURE on the top menu that is displayed.
2. Press the **Enhanced** soft key. The following menu items appear.

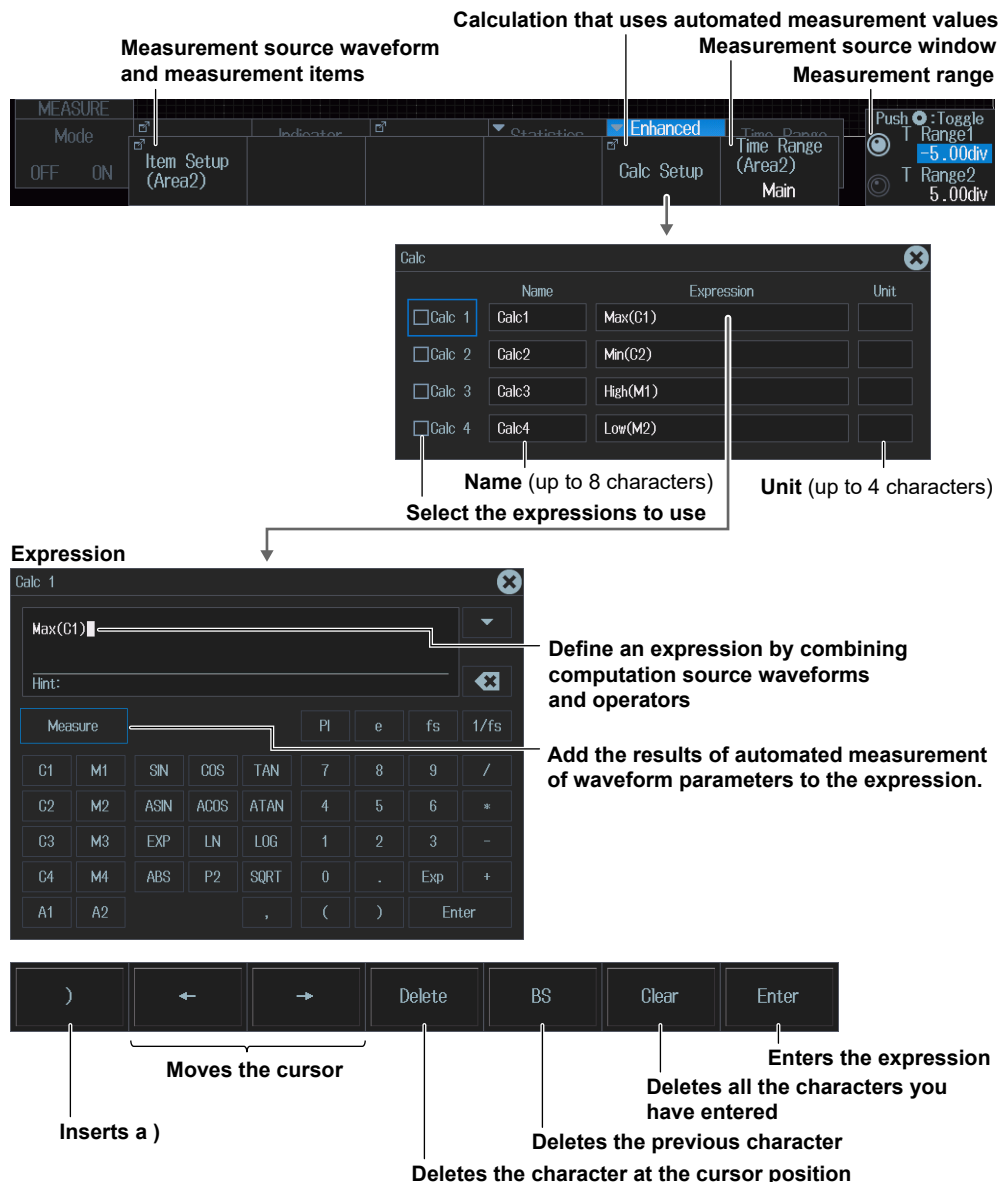

Measurement source waveform and measurement items

Calculation that uses automated measurement values

Measurement source window

Measurement range

Name	Expression	Unit
<input type="checkbox"/> Calc 1	Calc1	Max(C1)
<input type="checkbox"/> Calc 2	Calc2	Min(C2)
<input type="checkbox"/> Calc 3	Calc3	High(M1)
<input type="checkbox"/> Calc 4	Calc4	Low(M2)

Name (up to 8 characters)
Select the expressions to use

Unit (up to 4 characters)

Expression

Calc 1

Max(C1)

Hint:

Measure

C1	M1	SIN	COS	TAN	7	8	9	/
C2	M2	ASIN	ACOS	ATAN	4	5	6	*
C3	M3	EXP	LN	LOG	1	2	3	-
C4	M4	ABS	P2	SQRT	0	.	Exp	+
A1	A2				,	()	Enter

Define an expression by combining computation source waveforms and operators

Add the results of automated measurement of waveform parameters to the expression.

)	←	→	Delete	BS	Clear	Enter
---	---	---	--------	----	-------	-------

Moves the cursor

Inserts a)

Deletes the previous character

Deletes the character at the cursor position

Deletes all the characters you have entered

Enters the expression

Measurement Source Waveform and Measurement Items (Item Setup (Area2))

Press the **Item Setup (Area2)** soft key. The screen for setting the source waveform of Area2 and the measurement items are displayed.

The screen is the same as the Item Setup screen shown in section 9.1.

10.1 Zooming in or out of waveforms

This section explains the following settings for zooming in or out of waveforms:

- Turning zoom on or off
- Display format
- Main window display
- Auto scrolling
- Zoom source waveform
- Zoom position
- Zoom factor

► “Zooming in on Waveforms” in the Features Guide

ZOOM Menu

Press **ZOOM1** or **ZOOM2**. The following menu items appear.

- You can also tap **MENU** (☰) in the upper left of the screen and select the ZOOM1 menu or the ZOOM2 menu from ZOOM on the top menu that is displayed.
- The zoomed waveform of up to two locations can be displayed. To switch the setting menu, press **ZOOM1** or **ZOOM2**.

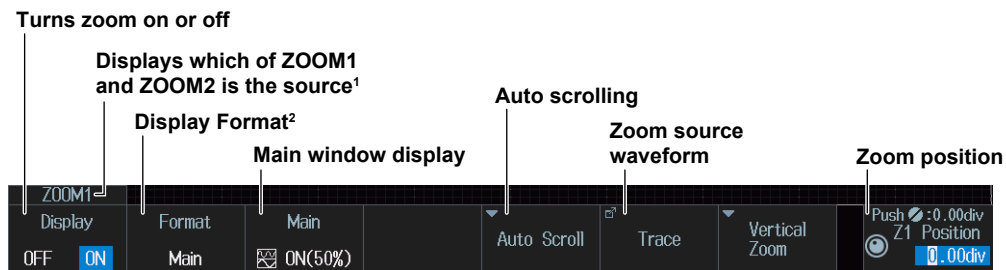

- 1 When both ZOOM1 and ZOOM2 illuminate, the key that illuminates most brightly corresponds to the setting menu item.
- 2 The display formats Quad, Hexa, and Octal can be set only for 4-channel models.

When both ZOOM1 and ZOOM2 illuminate

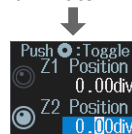

Note

Setting the Zoom Position

When both ZOOM1 and ZOOM2 illuminate, you can move the zoom positions of ZOOM1 and ZOOM2 in a linked manner by pressing SET a number of times to make the jog shuttle control both the Z1 Position and the Z2 Position.

Auto Scrolling (Auto Scroll)

Press the **Auto Scroll** soft key. The following menu items appear.

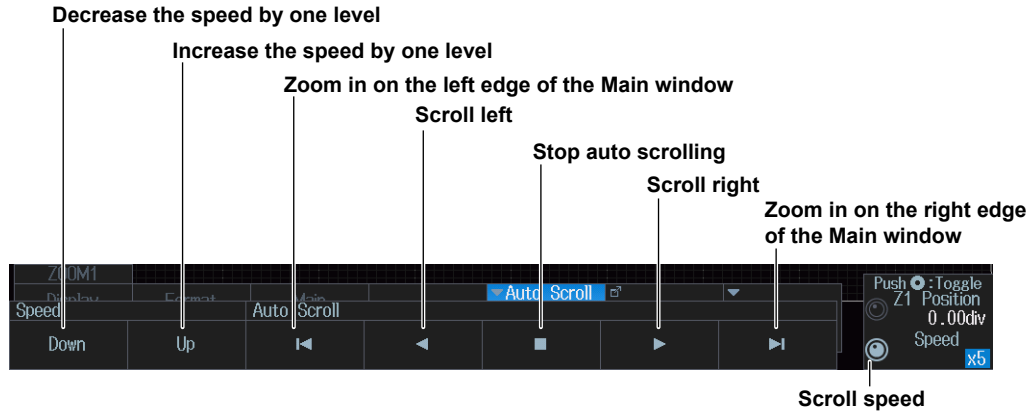

Setting the Zoom Factor (ZOOM knob)

1. Press **ZOOM1** or **ZOOM2** to select what the ZOOM knob controls.
 - When both the Zoom1 and Zoom2 windows are displayed, the waveform of the window of whichever is illuminated brightest of ZOOM1 and ZOOM2 is controlled by the ZOOM knob.
2. Use the **ZOOM** knob to set the magnification.
 - If you press the ZOOM knob, the FINE indicator illuminates, and you can set the zoom factor with higher resolution.
 - To adjust the zoom position, turn the jog shuttle.

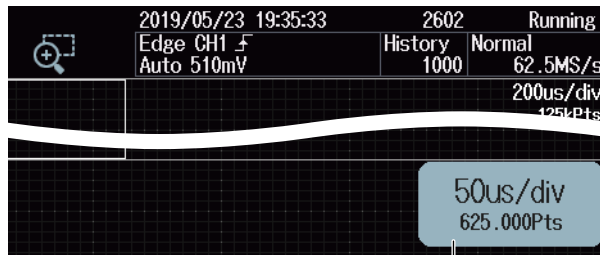
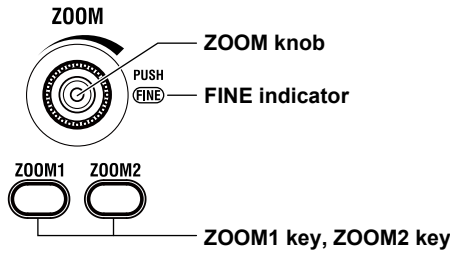

While you control the knob, the zoom value and display record length are displayed in the upper right of the zoom window. The display disappears after a few seconds when you stop controlling the knob.

10.2 Zooming in or out of Waveforms in the Vertical Direction

This section explains the following settings for zooming in or out of waveforms in the vertical direction:

► [“Vertical Zoom \(Vertical Zoom\)” in the Features Guide](#)

ZOOM Vertical Zoom menu

1. Press **ZOOM1** or **ZOOM2**. The ZOOM menu appears.
You can also tap **MENU** (MENU) in the upper left of the screen and select the ZOOM1 menu or the ZOOM2 menu from ZOOM on the top menu that is displayed.
2. Press the **Vertical Zoom** soft key. The following menu items appear.

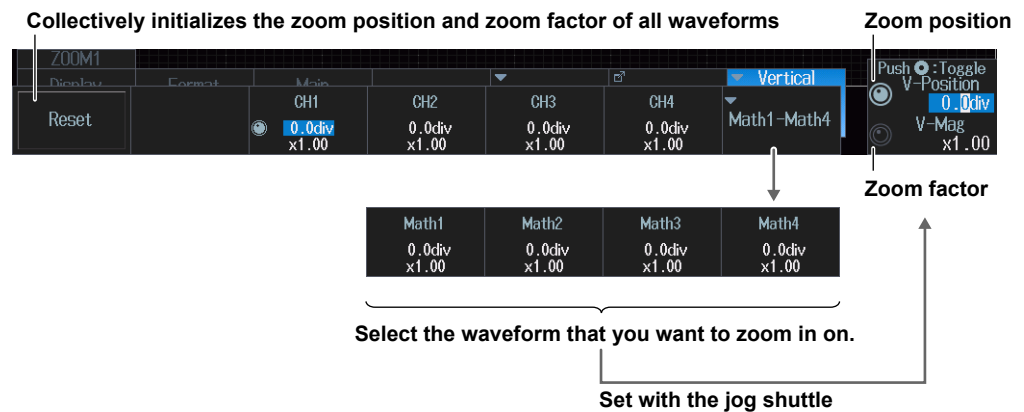

Note

- You can initialize the zoom position and zoom factor of the target waveform by pressing RESET on the front panel.
- You can initialize the zoom position and zoom factor of all waveforms by pressing the Reset soft key.

11.1 Searching for Edges

This section explains the following settings for searching for edges:

- Search type
- Search range
 - Search start and end points
- Search conditions
 - Search source waveform, strobe, level used to detect search source waveform edges, and hysteresis
- Detected waveform display
 - Turning the display of detected point markers on or off, zoom window, zoom position
- Search skipping
- Detected point number
- Executing searches

▶ “Search Type (Type),”
 “Search Range (Start/End Point),”
 “Search Conditions (Condition Setup),”
 “Displaying Detected Waveforms (Display Setup),” and
 “Search Skip (Skip Mode)” in the Features Guide

SEARCH Edge Menu

1. Press **SEARCH**. The SEARCH menu appears.
 You can also tap **MENU** (E) in the upper left of the screen and select the SEARCH menu from ANALYSIS on the top menu that is displayed.
2. Press the **Type** soft key and then the **Edge** soft key. The following menu items appear.

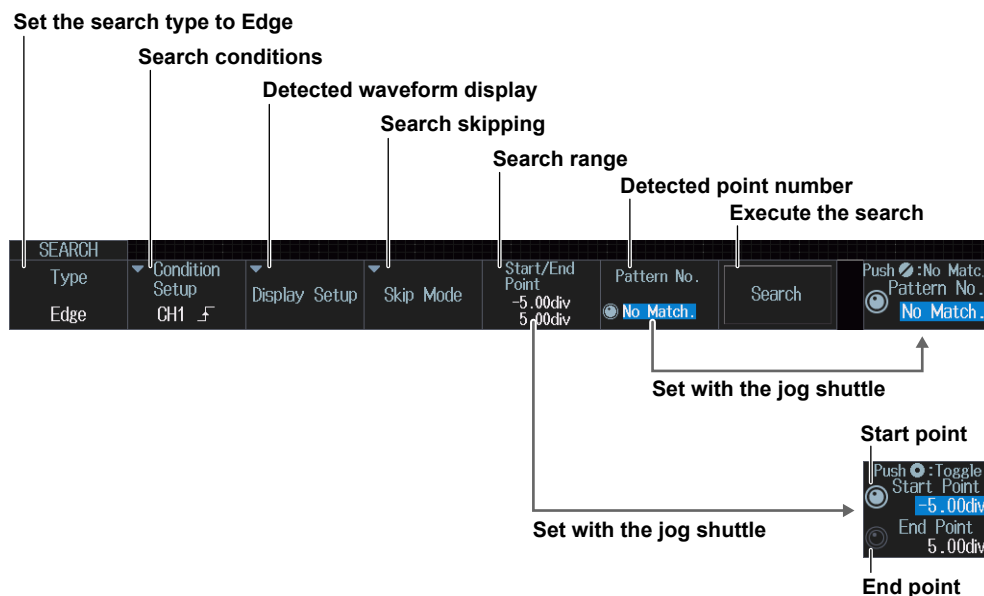

Search Conditions (Condition Setup)

Note

Using the CH4 Terminal and Logic Signal Input Port

When you execute a search, you cannot use the CH4 terminal and the logic signal input port as the source at the same time. Specify the source that you want to use in advance by pressing either CH4 or LOGIC.

Press the **Condition Setup** soft key. A menu appears according to the waveform to be searched you specified.

When the Search Source Waveform Is CH1 to CH4 or Math1 to Math4

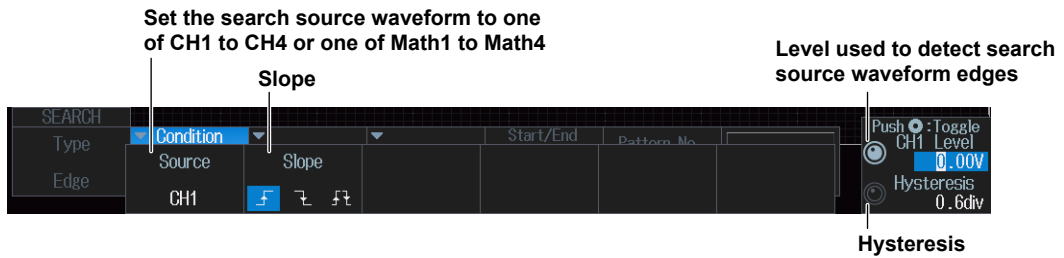

When the Search Source Waveform Is LOGIC (On models with the logic signal input port)

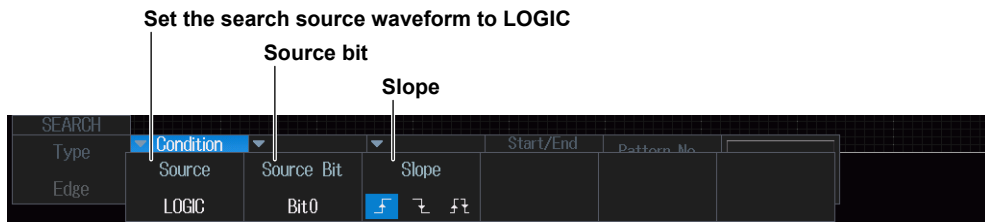

Detected Waveform Display (Display Setup)

Press the **Display Setup** soft key. The following menu items appear.

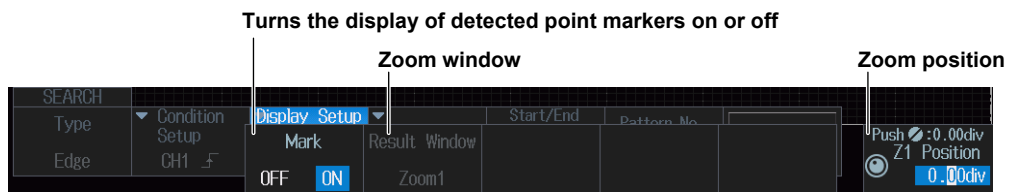

Turning the Display of Detected Point Markers ON or OFF(Mark)

You can display marks at the top of the main and zoom windows to clearly show the detected position on the waveform (the detected point mark). Marks that match detected point numbers are highlighted.

Zoom Windows (Result Window)

You can configure zoom windows Zoom1 and Zoom2 when they are displayed.

Zoom Position (Z1 Position/Z2 Position)

You can change the zoom position, which is the point on the waveform that is zoomed in on.

Search Skipping (Skip Mode)

Press the **Skip Mode** soft key. The following menu items appear.

After a search condition is met, you can skip the detection of search conditions for the specified amount of time or the specified number of counts.

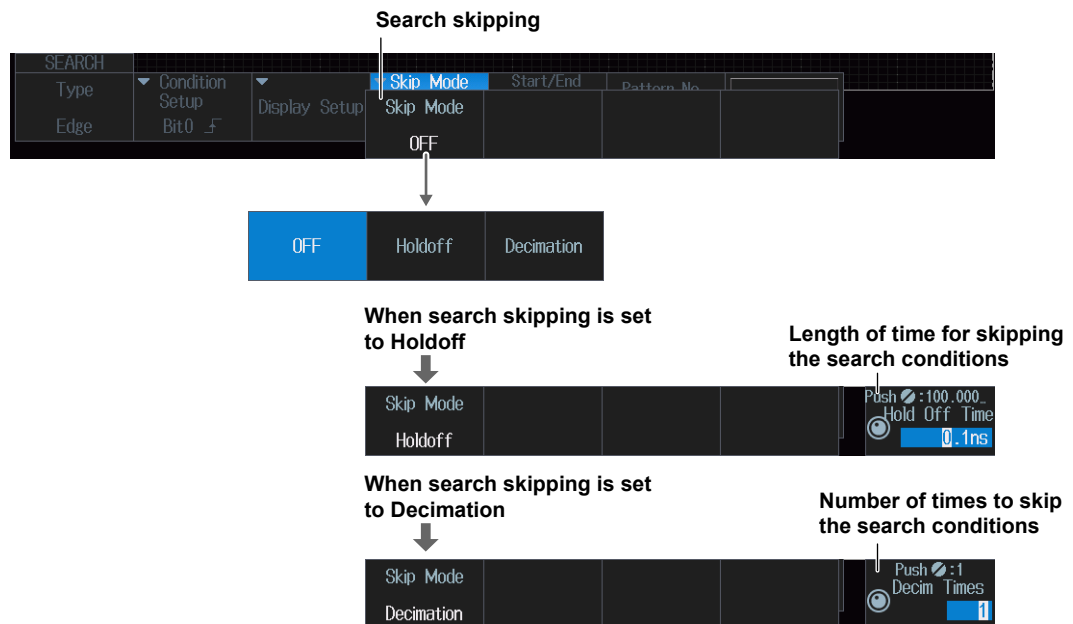

Executing a Search (Search)

1. Set the search conditions.
2. Press the **Search** soft key.

The instrument searches for the search conditions. If the instrument finds points that match the search conditions (detected points), it shows numbers (0, 1, 2, etc.) from the left of the waveform display in the order that the points were detected.

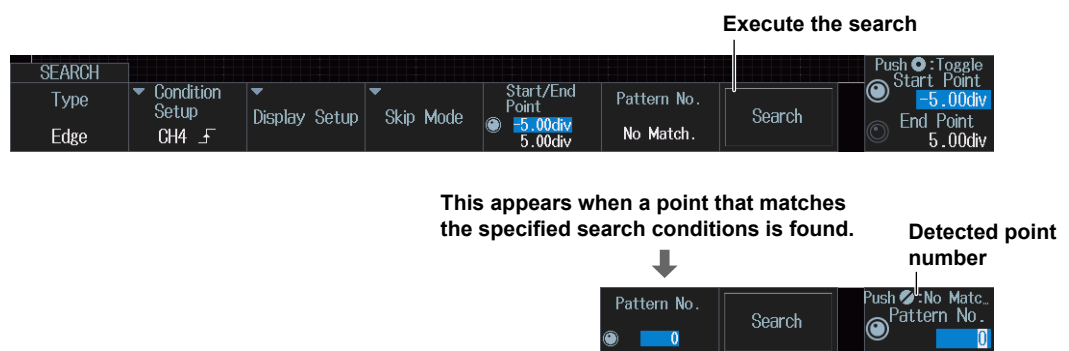

Detected Point Number (Pattern No.)

You can set the detected point number and display the waveform for the detected point on the zoom window.

11.2 Searching with Multiple Input Patterns

This section explains the following settings for searching with multiple input patterns:

- Search type
- Search range
- Search start and end points
- Search conditions
- Detected waveform display
- Detected point number
- Search skipping
- Executing searches

Clock source, comparison conditions (search source pattern, combination), achievement condition, time condition, reference time, level used to detect search source states, level used to detect clock source edges, hysteresis

► “Search Type (Type),”
“Search Range (Start/End Point),” and
“Search Conditions (Condition Setup)” in the Features Guide

SEARCH Pattern Menu

1. Press **SEARCH**. The SEARCH menu appears.
You can also tap **MENU** (☰) in the upper left of the screen and select the SEARCH menu from ANALYSIS on the top menu that is displayed.
2. Press the **Type** soft key and then the **Pattern** soft key. The following menu items appear.

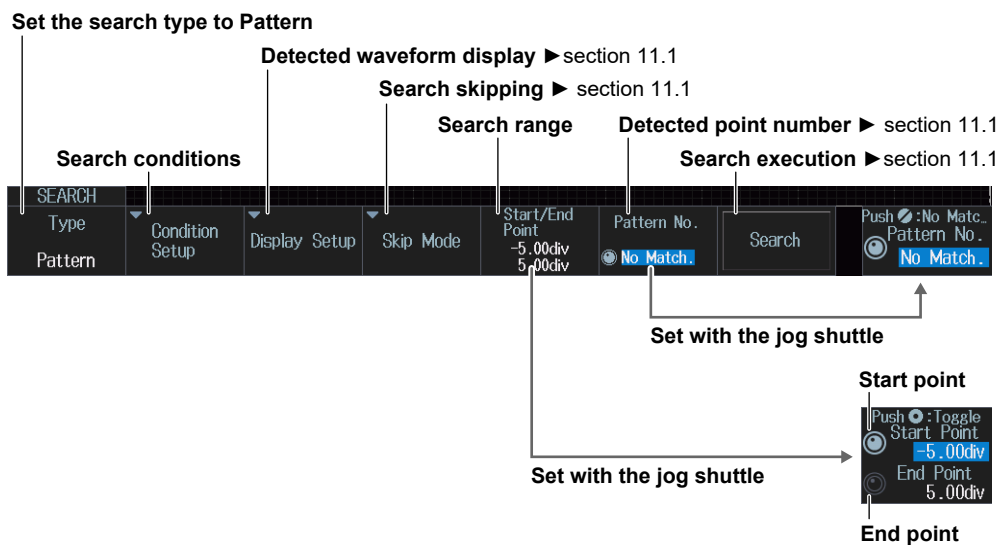

Search Conditions (Condition Setup)

Note

Using the CH4 Terminal and Logic Signal Input Port

When you execute a search, you cannot use the CH4 terminal and the logic signal input port as the source at the same time. Specify the source that you want to use in advance by pressing either CH4 or LOGIC.

Press the **Condition Setup** soft key. The following menu items appear.

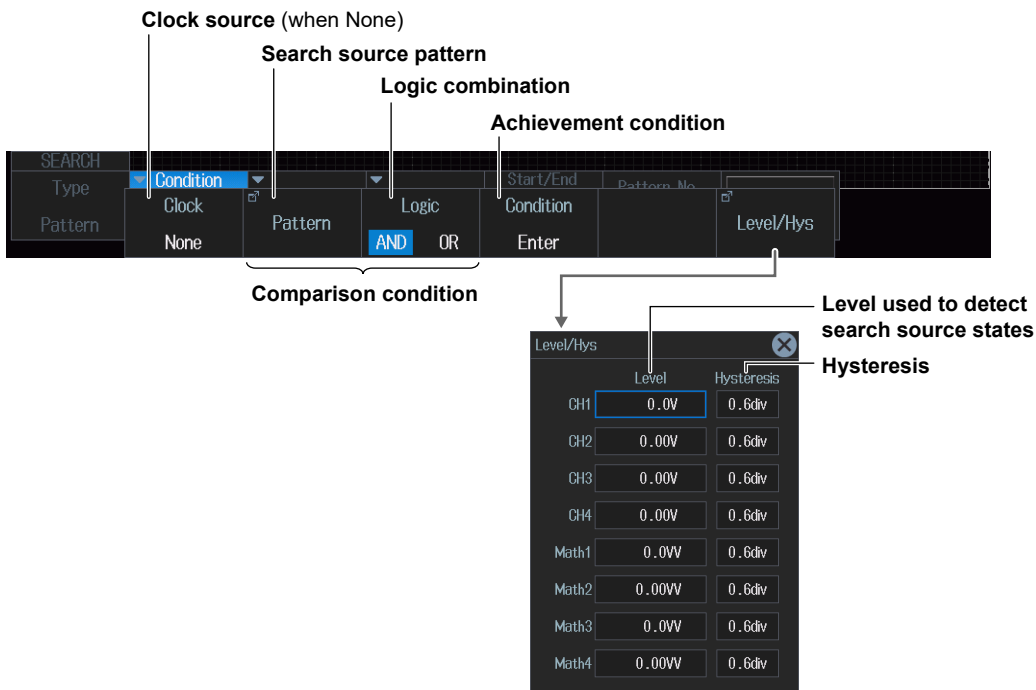

When the clock source is one of CH1 to CH4 or one of Math1 to Math4

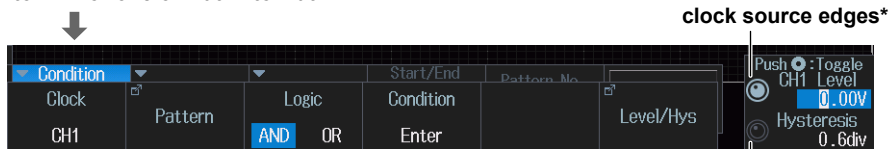

* You can also set the level and hysteresis for detecting clock source edges on the setup screen displayed by pressing the Levels/Hys soft key.

When the clock source is LOGIC
(On models with the logic signal input port)

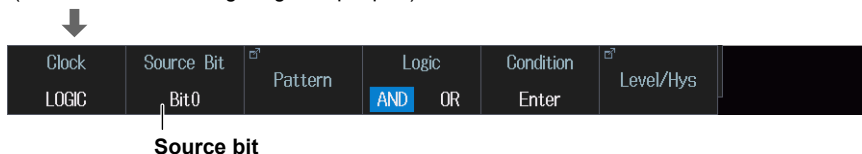

11.2 Searching with Multiple Input Patterns

Search Source Pattern (Pattern)

Press the **Pattern** soft key. The following menu items appear.

- **When the Clock Source Is CH1 to CH4 or LOGIC (On models with the logic signal input port)**

When the CH4 key is lit

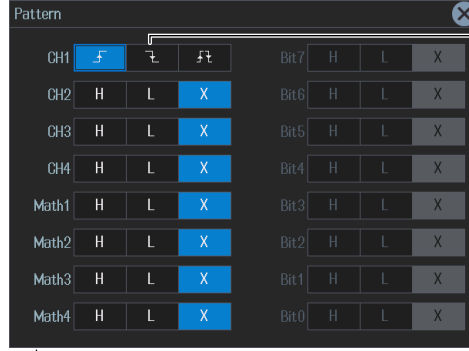

Set the slope of the signal set as the clock source

Set the pattern of the search source (signal other than the clock source) (LOGIC is invalid)

When the LOGIC key is lit

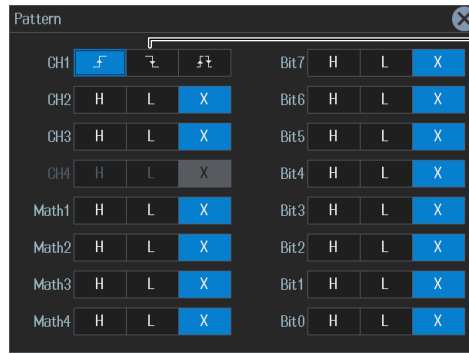

Set the slope of the signal set as the clock source

Set the pattern of the search source (signal other than the clock source) (CH4 is invalid)

- **No Clock Source**

The same menu appears as that shown above for when the clock source is CH1 to CH4 or LOGIC (on models with the logic signal input port). Because there is no clock source, set the pattern of the search sources (all of the CH1 to CH4 and LOGIC signals) (only one of CH4 or LOGIC, whose corresponding key is illuminated, can be selected).

Time Condition (Time Qualification)

If no clock source (None) is set, the time condition is set if the achievement condition is True or False. Press the **Time Qualification** soft key. The following menu items appear.

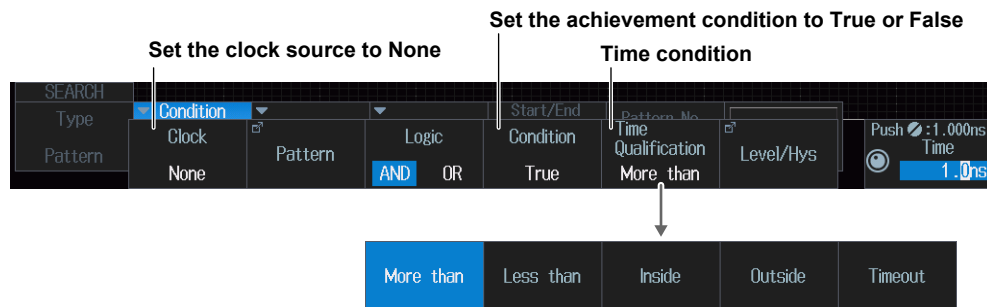

Set what kind of relationship must be established between the achievement time of the comparison condition and the specified reference times (Time or Time1 and Time2) for a point to be detected. For details on the detected points when the time condition is met, see chapter 14, “Searching Waveforms” in the *Features Guide* (IM DLM3054-01EN). When Timeout is selected, the instrument searches for timeout points.

- More than : When the comparison condition achievement time is longer than the specified reference time (Time)
- Less than : When the comparison condition achievement time is shorter than the specified reference time (Time)
- Inside : When the comparison condition achievement time is longer than reference time Time1 and shorter than reference time Time2.
- Outside : When the comparison condition achievement time is shorter than reference time Time1 or longer than reference time Time2.
- Timeout : When the comparison condition achievement time is longer than the specified reference time (Time)

Reference time (Time or Time1 and Time2)

- When the Time Condition is More than, Less than, or Timeout

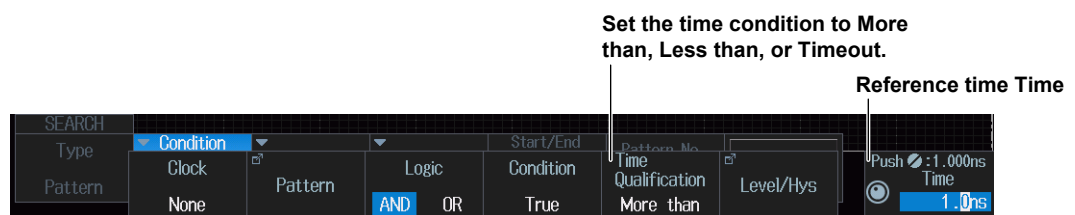

- When the Time Condition is Inside or Outside

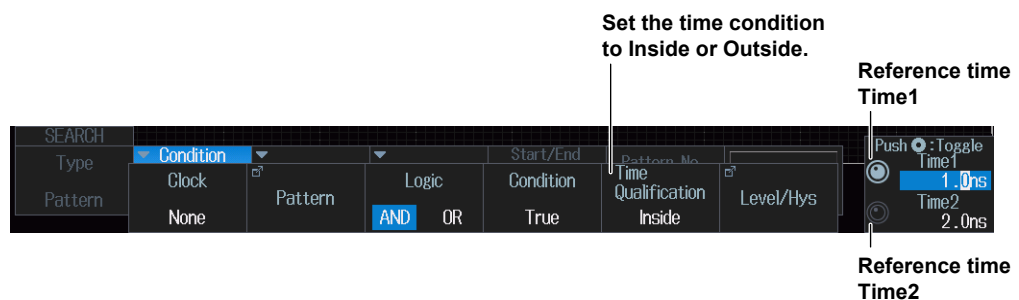

11.3 Searching for Pulse Width

This section explains the following settings for searching for pulse width:

- Search type
- Search range
- Search conditions
- Search start and end points
- Search conditions
- Search source waveform, polarity, time condition, reference time, level used to detect search source waveform states, and hysteresis
- Detected waveform display
- Search skipping
- Detected point number
- Executing searches

► “Search Type (Type),”
 “Search Range (Start/End Point),” and
 “Search Conditions (Condition Setup)” in the Features Guide

SEARCH Pulse Width Menu

1. Press **SEARCH**. The SEARCH menu appears.
 You can also tap **MENU** (E) in the upper left of the screen and select the SEARCH menu from ANALYSIS on the top menu that is displayed.
2. Press the **Type** soft key and then the **Pulse Width** soft key. The following menu items appear.

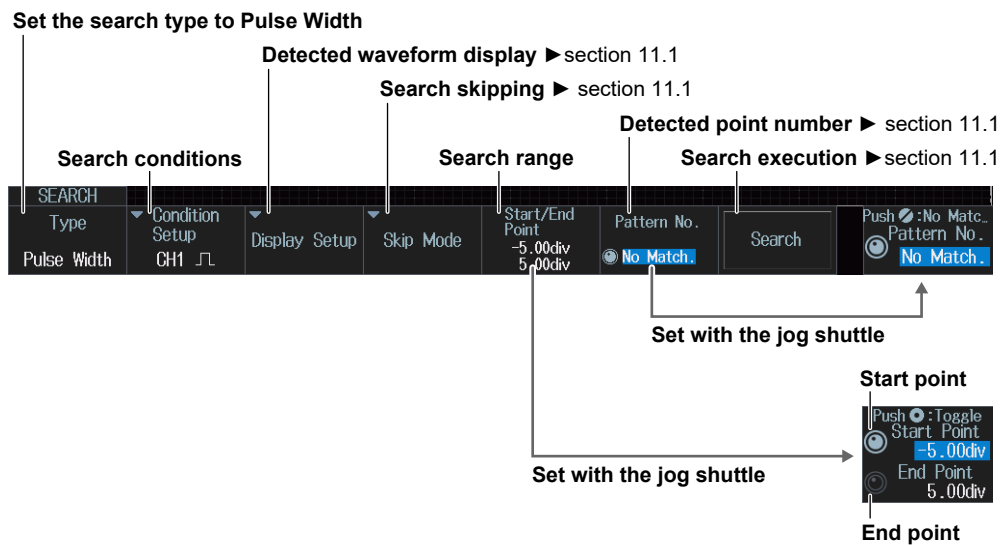

Search Conditions (Condition Setup)

Note

Using the CH4 Terminal and Logic Signal Input Port

When you execute a search, you cannot use the CH4 terminal and the logic signal input port as the source at the same time. Specify the source that you want to use in advance by pressing either CH4 or LOGIC.

Press the **Condition Setup** soft key. The following menu items appear.

Waveform to search

Polarity

Time condition

Reference time

SEARCH
Type: Pulse Width
Condition
Source: CH1
Polarity: [Square Wave Icon] [Inverted Square Wave Icon]
Time Qualification: More than
Start/End: [Blank]
Pattern No.: [Blank]
Time: 1.0ns
Level/Hys: 0.00V, 0.6div
Push: 1.000ns, 1.0ns

Set with the jog shuttle

Level used to detect search source waveform states

Set with the jog shuttle

Push: Toggle CH1 Level: 0.00V, Hysteresis: 0.6div

Hysteresis

When the search source waveform is LOGIC
(On models with the logic signal input port)

Source: LOGIC, Source Bit: Bit 0, Polarity: [Square Wave Icon] [Inverted Square Wave Icon], Time Qualification: More than, Push: 1.000ns, 1.0ns

Source bit

Reference time

Time Condition (Time Qualification)

Press the **Time Qualification** soft key. The following menu items appear.

SEARCH
Type: Pulse Width
Condition
Source: CH1
Polarity: [Square Wave Icon] [Inverted Square Wave Icon]
Time Qualification: More than
Start/End: [Blank]
Pattern No.: [Blank]
Level/Hys: [Blank]
Timeout: [Blank]

Set what kind of relationship must be established between the search source waveform's pulse width and the specified reference times (Time, Time1 and Time2) for a point to be detected. For details on the detected points when the time condition is met, see chapter 14, "Searching Waveforms" in the *Features Guide* (IM DLM3054-01EN). When Timeout is selected, the instrument searches for timeout points.

- More than : When the pulse width is longer than the specified reference time (Time)
- Less than : When the pulse width is shorter than the specified reference time (Time)
- Inside : When the pulse width is longer than Time1 but shorter than Time2
- Outside : When the pulse width is shorter than Time1 or longer than Time2
- Timeout : When the pulse width is longer than the specified reference time (Time)

11.3 Searching for Pulse Width

Reference Times (Time or Time1 and Time2)

- When the Time Condition is More than, Less than, or Timeout

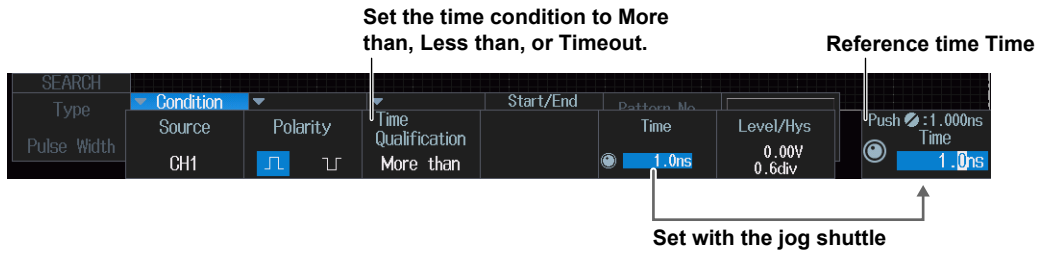

When the search source waveform is LOGIC (on models with the logic signal input port)

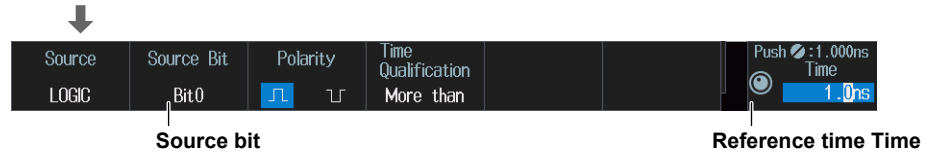

- When the Time Condition is Inside or Outside

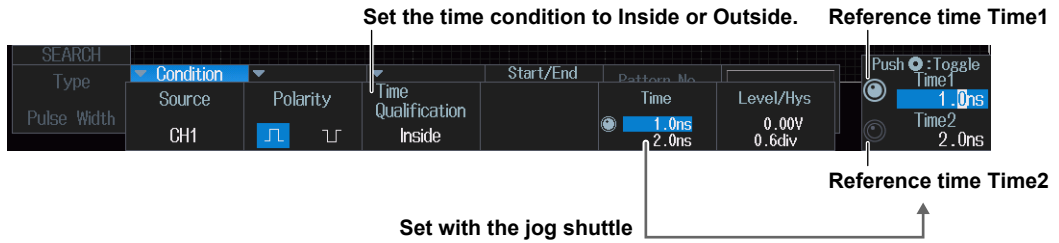

When the search source waveform is LOGIC
(On models with the logic signal input port)



11.4 Searching for Timeout Periods

This section explains the following settings for searching for timeout periods:

- Search type
- Search range
 - Search start and end points
- Search conditions
 - Search source waveform, polarity, timeout period, level used to detect search source waveform states, and hysteresis
- Detected waveform display
- Search skipping
- Detected point number
- Executing searches

► “Search Type (Type),”
“Search Range (Start/End Point),” and
“Search Conditions (Condition Setup)” in the Features Guide

SEARCH Timeout Menu

1. Press **SEARCH**. The SEARCH menu appears.
You can also tap **MENU** (MENU) in the upper left of the screen and select the SEARCH menu from ANALYSIS on the top menu that is displayed.
2. Press the **Type** soft key and then the **Timeout** soft key. The following menu items appear.

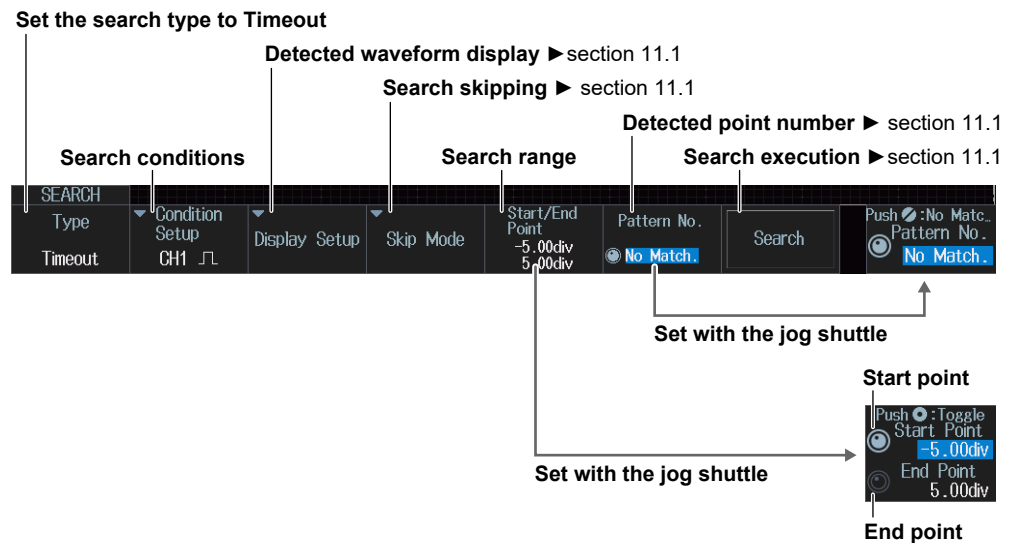

Search Conditions (Condition Setup)

Note

Using the CH4 Terminal and Logic Signal Input Port

When you execute a search, you cannot use the CH4 terminal and the logic signal input port as the source at the same time. Specify the source that you want to use in advance by pressing either CH4 or LOGIC.

Press the **Condition Setup** soft key. The following menu items appear.

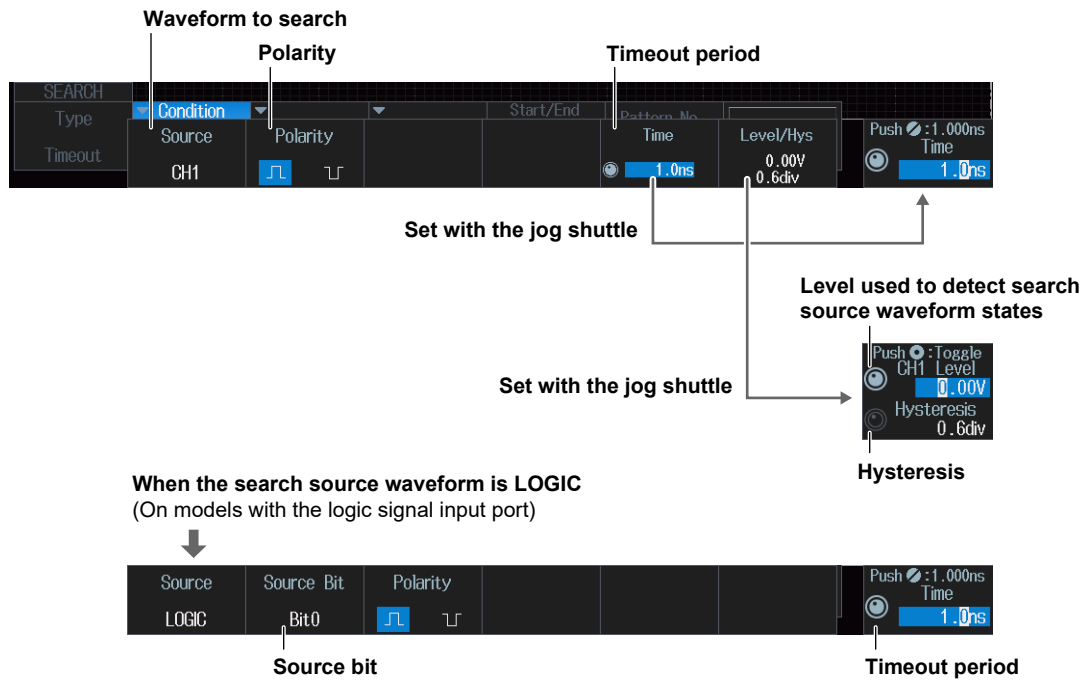

12.1 Analyzing and Searching FlexRay Bus Signals (Option)

This section explains the following settings for analyzing or searching FlexRay bus signals:

- Turning analysis and search displays on or off
- Serial bus signal types
 - Auto setup, analysis/search source waveform, bit rate, bus channel, level used to detect analysis/search source waveform states, hysteresis
- Decoded display
- List display
 - List size, display position, and zoom linking
- Analysis number
- Zoom position
- Search settings
 - Jumping to the specified field, zoom window, search type, and search execution

▶ [“Analyzing and Searching Serial Bus Signals”](#) and [“Analyzing and Searching FlexRay Bus Signals \(Option\)”](#) in the Features Guide

SERIAL BUS FlexRay Menu

1. Press **SHIFT+SEARCH** (SERIAL BUS). The SERIAL BUS menu appears.
 - You can also tap **MENU** (☰) in the upper left of the screen and select the SERIAL BUS menu from ANALYSIS on the top menu that is displayed.
 - You can also press **ANALYSIS** and then the **To SERIAL BUS** soft key to display the SERIAL BUS menu.
 - The instrument can analyze and search the waveforms of up to four serial bus signals. To switch the setup menu, press the **Serial Bus** soft key and select a number from 1 to 4.
2. Press the **Type** soft key. Select **FlexRay** from the setup menu that is displayed. The following menu items appear.

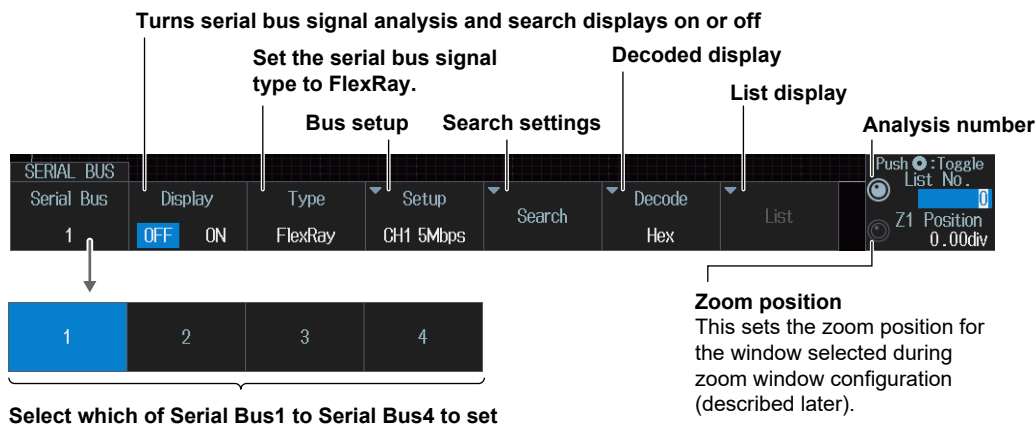

Bus Setup (Setup)

Note

Using the CH4 Terminal and Logic Signal Input Port

If you perform an analysis or execute a search when using the logic signal input ports for input, you cannot specify CH4 as the source. Press CH4 in advance to enable input from the CH4 terminal.

Press the **Setup** soft key. The following menu items appear.

Execute automatic setup

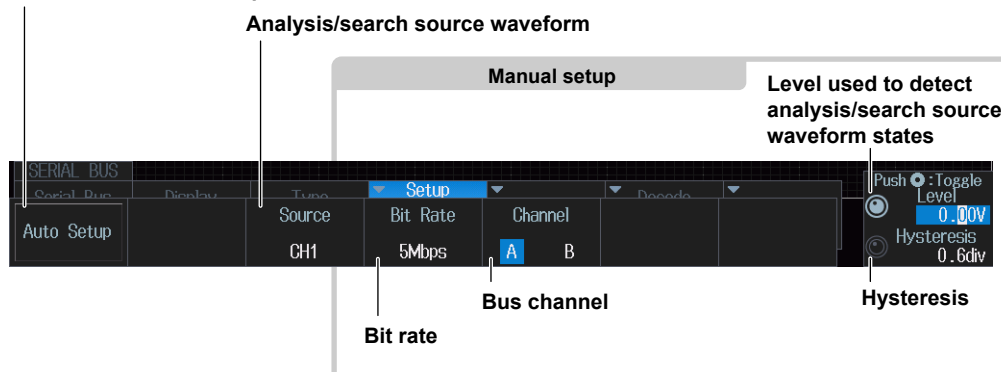

Auto Setup (Auto Setup)

1. Set the source waveform for search/analysis.
Auto setup cannot be performed when the source is set to Math1 to Math4.
2. Press the **Auto Setup** soft key.
The instrument will perform auto setup.
The instrument automatically configures the bit rate, bus channel, level, and hysteresis, and triggers on the start of frame (SOF) of the FlexRay bus signal.
While the serial bus is being configured, Auto Setup changes to Abort. If you want to stop, press the **Abort** soft key.

The auto setup feature will not work properly on some input signals.

Manual setup

After running auto setup, you can change the following settings and display decoded results.

- Analysis/search source waveform
- Bit rate
- Bus channel
- Level used to detect analysis/search source waveform states
- Hysteresis

Decoded Display (Decode)

Press the **Decode** soft key. The following menu items appear.

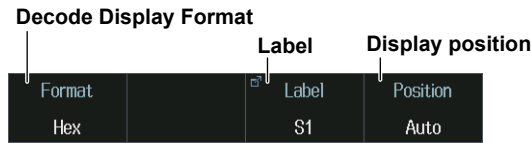

When the display position is set to Manual

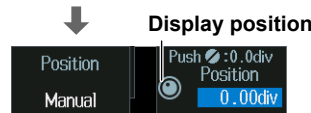

Decode Display Format (Format)

Select the decode display format.

Label (Label)

Select the decode displayed label.

Display Position (Position)

Set the display position of decoded results. The position is set to Auto when you execute auto setup on the analysis menu of each serial bus signal. The position changes from Auto to Manual when you drag the decode display.

List Display (List)

1. Press the **Display** soft key and turn on the analysis and search displays.
2. Press the **List** soft key.
 - The list of analysis results and the next menu appear.
 - If several display settings of Serial Bus 1 to 4 are on, all the lists of analysis results of the serial buses whose display setting is on are displayed. For details, see section 12.12.

List of analysis results

No.	Time(ms)	S/D	IND	ID	Len	CC	Data	Information
0	-0.000184	D	1111	8	6	3	01 01 01 01 01 02 02 02 02 03 03 03 03	
1	0.051016	S	0011	1	4	4	01 01 01 01 01 01 01 01	CRC Error
2	0.102216	S	0011	2	4	4	02 02 02 02 02 02 02 02	
3	0.153416	S	0010	3	4	4	03 03 03 03 03 03 03 03	
4	0.204616	S	1111	4	4	4	01 02 03 04 05 06 07 08	
5	0.255816	S	0000	5	4	4	00 00 00 00 00 00 00 00	
6	0.307016	D	1111	6	5	4	C8 C9 CA CB CC CD CE CF D0 D1	
7	0.358216	D	1111	7	2	4	FF FF FF FF	
8	0.409416	D	1111	8	6	4	01 01 01 01 02 02 02 02 03 03 03 03	
9	0.460616		0011	1	4	5	01 01 01 01 01 01 01 01	HCRC Error

Analysis number

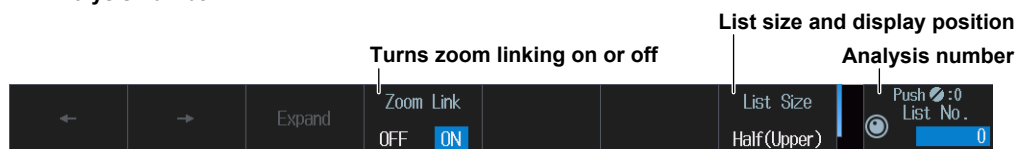

Data before the trigger position (on the left side of the waveform display) is assigned analysis numbers in descending order (-1, -2, and so on). Data after the trigger position (on the right side of the waveform display) is assigned analysis numbers in ascending order (0, 1, 2, and so on).

Search Setup (Search)

Press the **Search** soft key. The following menu items appear.

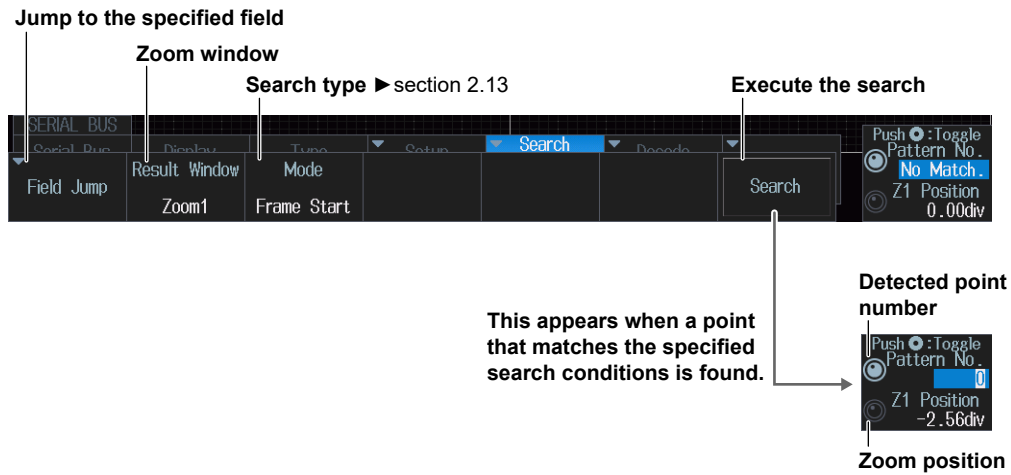

Jumping to the Specified Field (Field Jump)

Jumps to the field in the data frame that corresponds to the specified detected point number (Pattern No).

Zoom Windows (Result Window)

You can configure zoom windows Zoom1 and Zoom2 when they are displayed. Zoom1 is automatically displayed during the automatic setup of the analysis settings.

Search Type (Mode)

You can set this setting in the same way that you set the trigger type to Frame Start, Error, or ID/Data. For details, see section 2.13.

Executing a Search (Search)

1. Set the search type.
2. Press the **Search** soft key.

The instrument searches for the search conditions. If the instrument finds points that match the search conditions (detected points), it shows numbers (0, 1, 2, etc.) from the left of the waveform display in the order that the points were detected.

Detected Point Number (Pattern No.)

You can set the detected point number and display the waveform for the detected point on the zoom window.

Zoom Position (Z1 Position/Z2 Position)

You can change the zoom position, which is the point on the waveform that is zoomed in on.

12.2 Analyzing and Searching CAN Bus Signals (Option)

This section explains the following settings for analyzing or searching CAN bus signals:

- Turning analysis and search displays on or off
- Serial bus signal types
- Bus setup
 - Auto setup, analysis/search source waveform, bit rate, recessive level, sample point, level used to detect analysis/search source waveform states, hysteresis
- Decoded display
- List display
 - List size, display position, and zoom linking
- Zoom position
- Analysis number
- Search settings
 - Jumping to the specified field, zoom window, search type, and search execution

► “Analyzing and Searching Serial Bus Signals” and
“Analyzing and Searching CAN Bus Signals (Option)” in the Features Guide

SERIAL BUS CAN Menu

1. Press **SHIFT+SEARCH** (SERIAL BUS). The SERIAL BUS menu appears.
 - You can also tap **MENU** (☰) in the upper left of the screen and select the SERIAL BUS menu from ANALYSIS on the top menu that is displayed.
 - You can also press **ANALYSIS** and then the **To SERIAL BUS** soft key to display the SERIAL BUS menu.
 - The instrument can analyze and search the waveforms of up to four serial bus signals. To switch the setup menu, press the **Serial Bus** soft key and select a number from 1 to 4.
2. Press the **Type** soft key. Select **CAN** from the setup menu that is displayed. The following menu items appear.

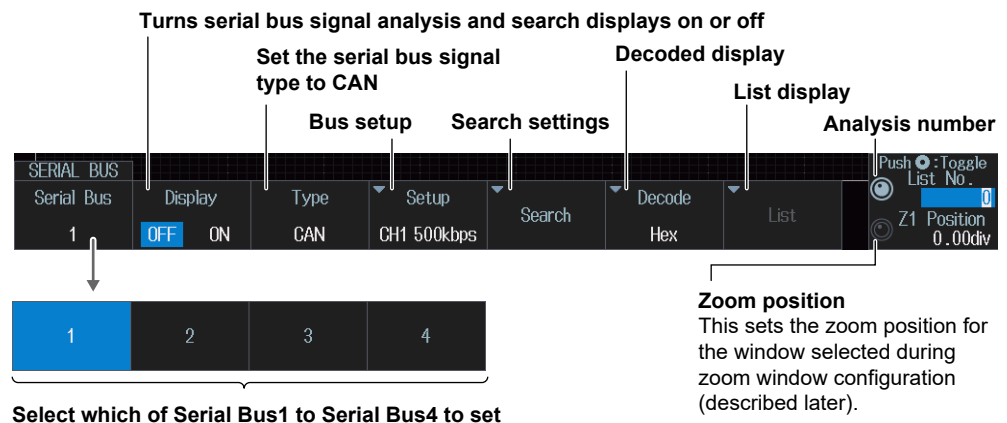

Bus Setup (Setup)

Note

Using the CH4 Terminal and Logic Signal Input Port

If you perform an analysis or execute a search when using the logic signal input ports for input, you cannot specify CH4 as the source. Press CH4 in advance to enable input from the CH4 terminal.

Press the **Setup** soft key. The following menu items appear.

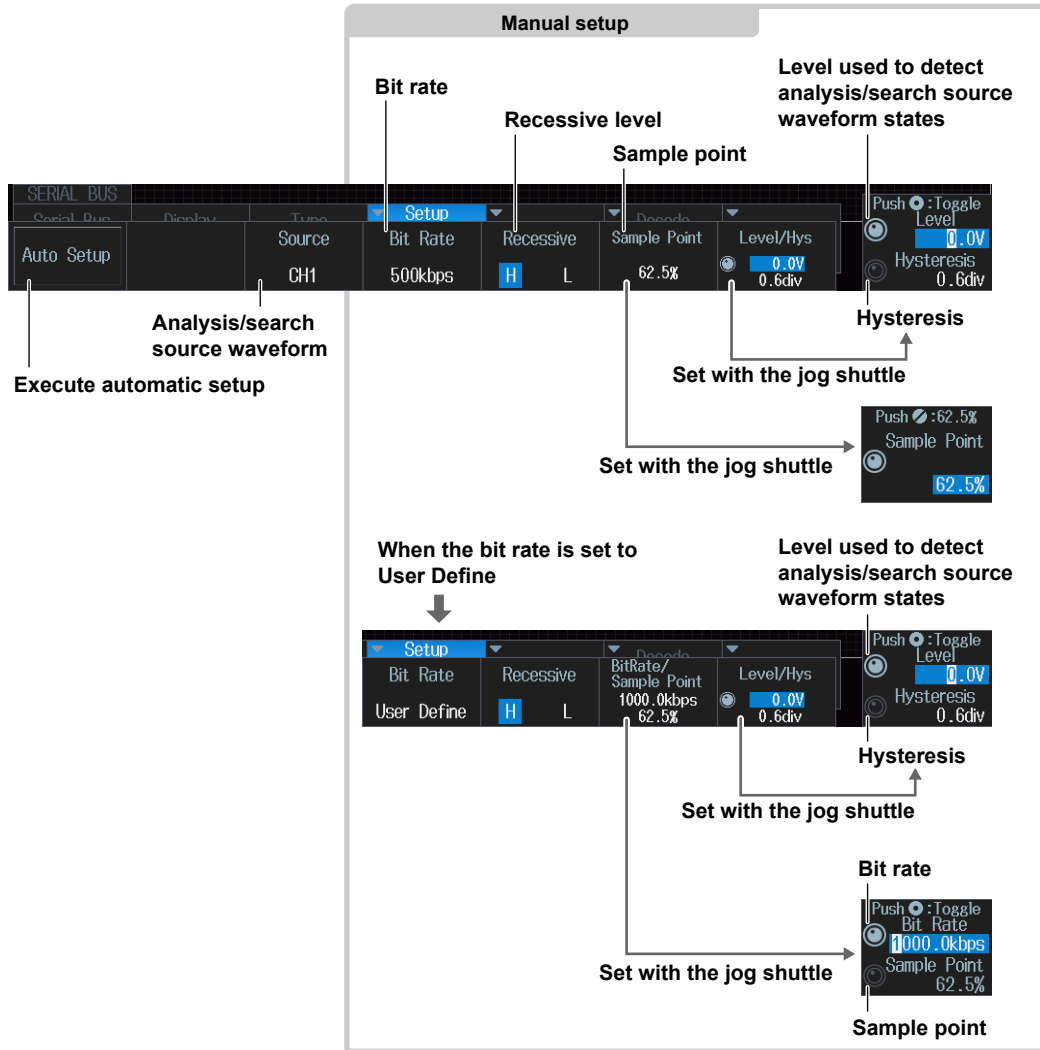

Auto Setup (Auto Setup)

1. Set the source waveform for search/analysis.
Auto setup cannot be performed when the source is set to Math1 to Math4.
2. Press the **Auto Setup** soft key.
The instrument will perform auto setup.
The instrument automatically configures the bit rate, recessive level, sample point, level, and hysteresis and triggers on the start of frame (SOF) of the CAN bus signal.
While the serial bus is being configured, Auto Setup changes to Abort. If you want to stop, press the **Abort** soft key.

The auto setup feature will not work properly on some input signals.

Manual Setup

After running auto setup, you can change the following settings and display decoded results.

- Analysis/search source waveform
- Bit rate
- Recessive level
- Sample point
- Level used to detect analysis/search source waveform states
- Hysteresis

Decoded Display (Decode)

Press the **Decode** soft key. The following menu items appear.

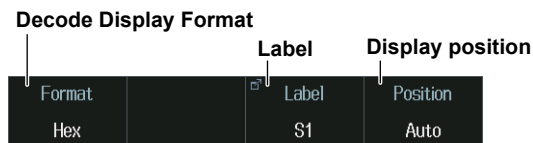

When the display position is set to Manual

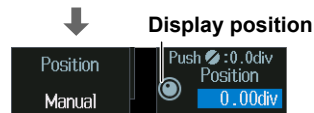

Decode Display Format (Format)

Select the decode display format.

When you set decode display to Symbol, you can select display CANdB symbols if you load the physical value/symbol definition file (.sbl).

Label (Label)

Select the decode displayed label.

Display Position (Position)

Set the display position of decoded results. The position is set to Auto when you execute auto setup on the analysis menu of each serial bus signal. The position changes from Auto to Manual when you drag the decode display.

List Display (List)

1. Press the **Display** soft key and turn on the analysis and search displays.
2. Press the **List** soft key.
 - The list of analysis results and the next menu appear.
 - If several display settings of Serial Bus 1 to 4 are on, all the lists of analysis results of the serial buses whose display setting is on are displayed. For details, see section 12.12.

List of analysis results

No.	Time(ms)	Frame	ID	DLC	Data	CRC	Ack	Information
0	-0.0052	Data	100	3	FF 01 A4	6C6E	Y	
1	2.5788	Data	00A	2	01 02	4A24	Y	
2	5.0908	Data	012	1	FE	2263	Y	
3	7.5308	Data	100	3	FF 01 A4	6C6E	Y	
4	10.1148	Data	00A	2	01 02	4A24	Y	
5	12.6268	Data	012	1	FE	2263	Y	
6	15.0668	Data	100	3	FF 01 A4	6C6E	Y	
7	17.6508	Data	00A	2	01 02	4A24	Y	
8	20.1628	Data	012	1	FE	2263	Y	
9	22.6028	Data	100	3	FF 01 A4	6C6E	Y	

Analysis number

List size and display position

Turns zoom linking on or off

Analysis number

Data before the trigger position (on the left side of the waveform display) is assigned analysis numbers in descending order (-1, -2, and so on). Data after the trigger position (on the right side of the waveform display) is assigned analysis numbers in ascending order (0, 1, 2, and so on).

Search Setup (Search)

Press the **Search** soft key. The following menu items appear.

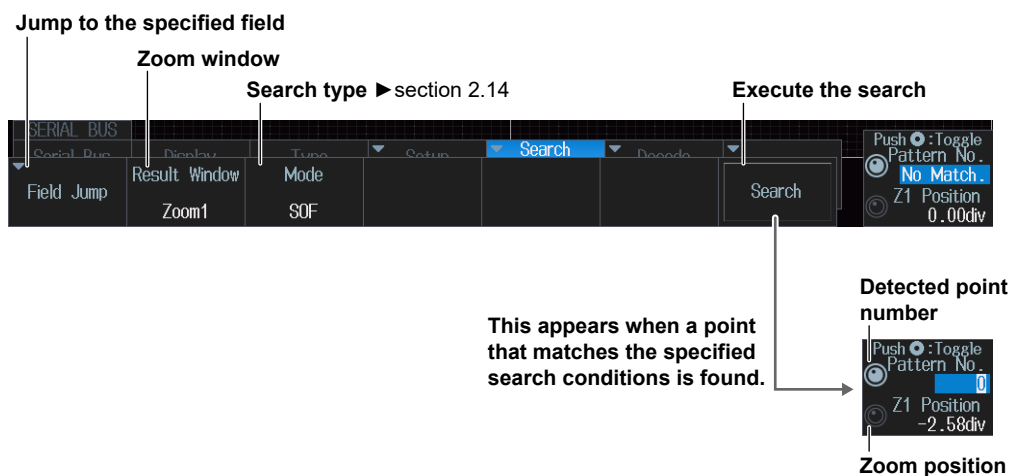

Jumping to the Specified Field (Field Jump)

Jumps to the field in the data frame that corresponds to the specified detected point number (Pattern No).

Zoom Windows (Result Window)

You can configure zoom windows Zoom1 and Zoom2 when they are displayed. Zoom1 is automatically displayed during the automatic setup of the analysis settings.

Search Type (Mode)

You can set this setting in the same way that you set the trigger type to SOF, Error, or ID/Data. For details, see section 2.14.

Executing a Search (Search)

1. Set the search type.
2. Press the **Search** soft key.

The instrument searches for the search conditions. If the instrument finds points that match the search conditions (detected points), it shows numbers (0, 1, 2, etc.) from the left of the waveform display in the order that the points were detected.

Detected Point Number (Pattern No.)

You can set the detected point number and display the waveform for the detected point on the zoom window.

Zoom Position (Z1 Position/Z2 Position)

You can change the zoom position, which is the point on the waveform that is zoomed in on.

12.3 Analyzing and Searching CAN FD Bus Signals (Option)

This section explains the following settings (which are used when analyzing or searching CAN FD bus signals):

- Turning analysis and search displays on or off
- Serial bus signal types
- Bus setup
 - Auto setup, analysis/search source waveform, bit rate, recessive level, sample point, data phase bit rate, data phase sample point, recessive level, CAN FD standard, level used to detect analysis/search source waveform states, hysteresis
- Decoded display
- List display
 - List size, display position, and zoom linking
- Analysis number
- Zoom position
- Search settings
 - Jumping to the specified field, zoom window, search type, and search execution

► [“Analyzing and Searching Serial Bus Signals”](#) and [“Analyzing and Searching CAN FD Bus Signals \(Option\)”](#) in the Features Guide

SERIAL BUS CAN FD Menu

1. Press **SHIFT+SEARCH** (SERIAL BUS). The SERIAL BUS menu appears.
 - You can also tap **MENU** (E) in the upper left of the screen and select the SERIAL BUS menu from ANALYSIS on the top menu that is displayed.
 - You can also press **ANALYSIS** and then the **To SERIAL BUS** soft key to display the SERIAL BUS menu.
 - The instrument can analyze and search the waveforms of up to four serial bus signals. To switch the setup menu, press the **Serial Bus** soft key and select a number from 1 to 4.
2. Press the **Type** soft key. Select **CAN FD** from the setup menu that is displayed. The following menu items appear.

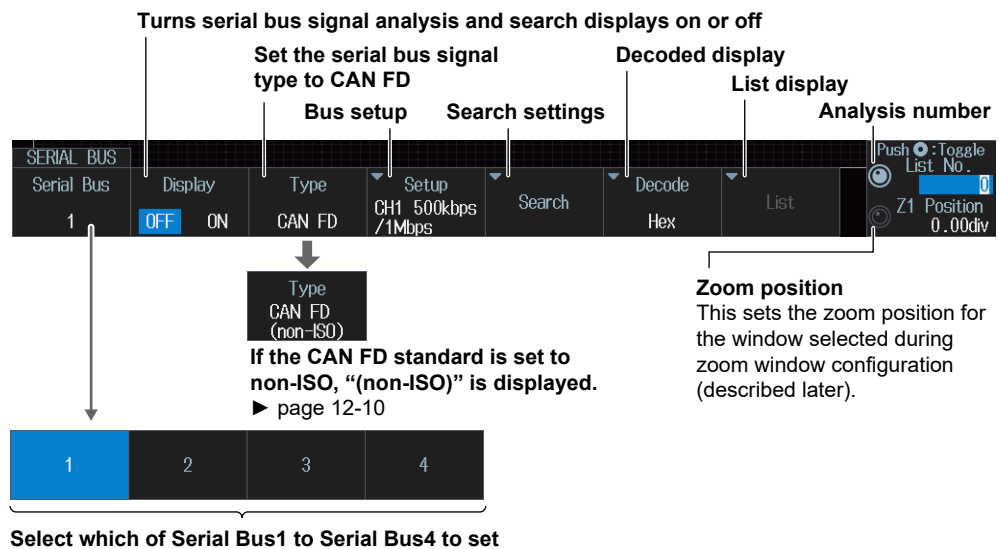

Bus Setup (Setup)

Note

Using the CH4 Terminal and Logic Signal Input Port

If you perform an analysis or execute a search when using the logic signal input ports for input, you cannot specify CH4 as the source. Press CH4 in advance to enable input from the CH4 terminal.

Press the **Setup** soft key. The following menu items appear.

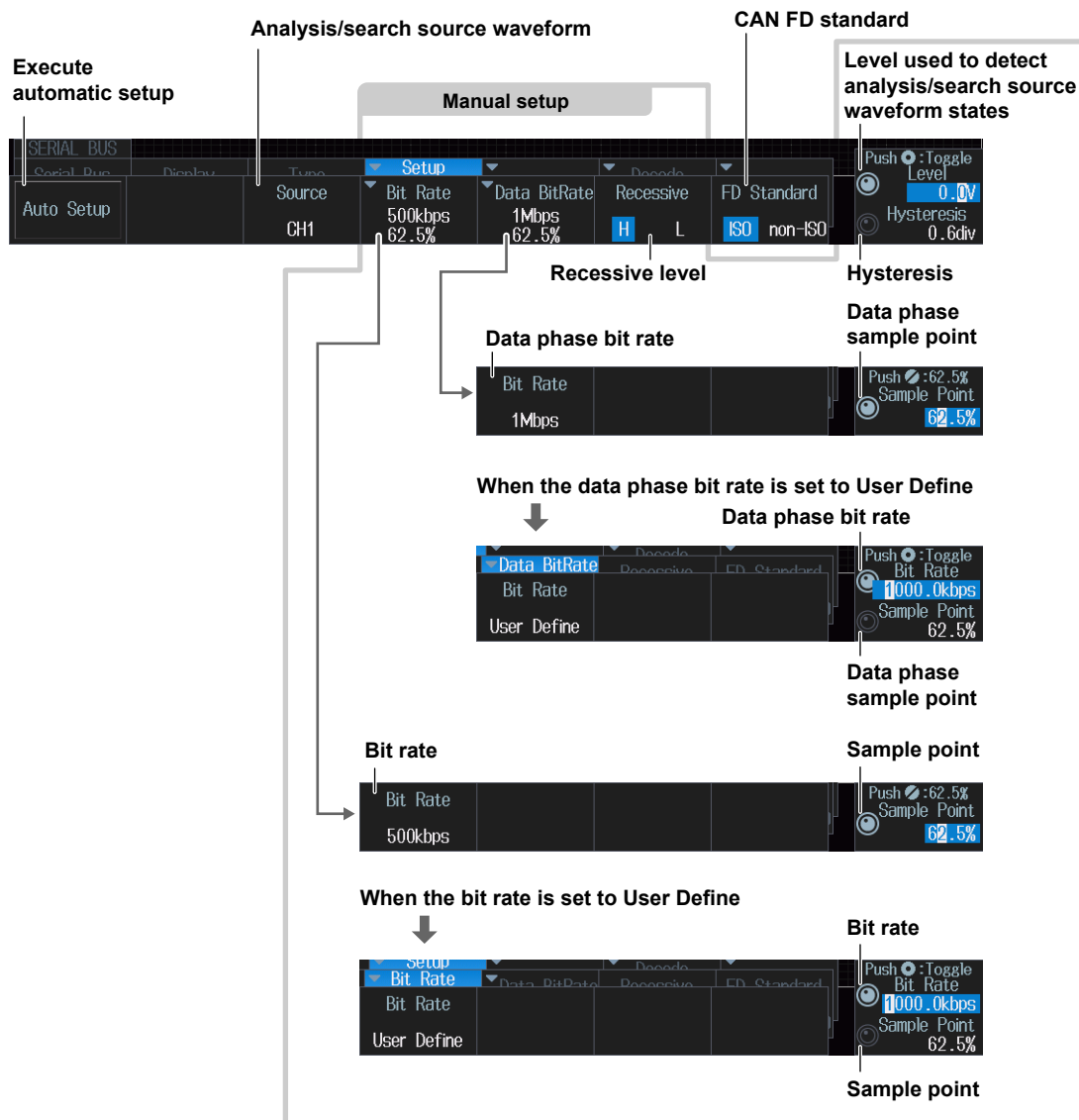

Auto Setup (Auto Setup)

1. Set the analysis/search source waveform and CAN FD standard.
If you set the analysis/search source waveform to Math1 to Math4, auto setup is not possible.
2. Press the **Auto Setup** soft key.
The instrument will perform auto setup.
The auto setup feature automatically configures the bit rate, sample point, data phase bit rate, data phase sample point, recessive level, level, and hysteresis, and triggers on the start of frame (SOF) of the CAN FD bus signal.

While the serial bus is being configured, Auto Setup changes to Abort. If you want to stop, press the **Abort** soft key.

The auto setup feature will not work properly on some input signals.

12.3 Analyzing and Searching CAN FD Bus Signals (Option)

Manual setup

After running auto setup, you can change the following settings and display decoded results.

- Analysis/search source waveform
- Bit rate
- Sample point
- Data phase bit rate
- Data phase sample point
- Recessive level
- CAN FD standard
- Level used to detect analysis/search source waveform states
- Hysteresis

Decoded Display (Decode)

Press the **Decode** soft key. The following menu items appear.

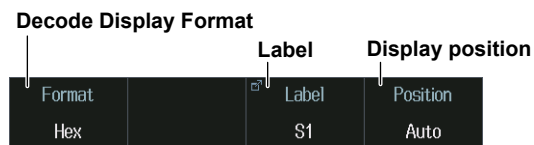

When the display position is set to Manual

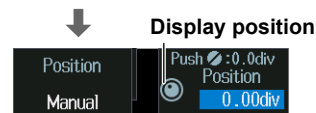

Decode Display Format (Format)

Select the decode display format.

When you set decode display to Symbol, you can select display CANdB symbols if you load the physical value/symbol definition file (.sbl).

Label (Label)

Select the decode displayed label.

Display Position (Position)

Set the display position of decoded results. The position is set to Auto when you execute auto setup on the analysis menu of each serial bus signal. The position changes from Auto to Manual when you drag the decode display.

List Display (List)

1. Press the **Display** soft key and turn on the analysis and search displays.
2. Press the **List** soft key.
 - The list of analysis results and the next menu appear.
 - If several display settings of Serial Bus 1 to 4 are on, all the lists of analysis results of the serial buses whose display setting is on are displayed. For details, see section 12.12.

List of analysis results

When the CAN FD standard is set to ISO

No.	Time(ms)	Frame	ID	DLC	Data	SC	CRC	Ack	Information
0	-0.001272	FD Data	00000000	4	00 00 00 00	C		Y	CRC Error(SC),Fixed Stuff Error
1	0.610728	FD Data	1FFFFFFF	4	FF FF FF FF	2		Y	CRC Error(SC),Fixed Stuff Error
2	1.042728	FD Data	15555555	C	55 AA C3 0F 55 AA C3 0F 55 AA C3 0F 55 AA C3 0F 55 AA C3 0F 55 AA C3 0F	0		Y	Fixed Stuff Error
3	1.676736	FD Data	0AAAAAAA	C	AA 55 3C F0 AA 55 3C F0 AA 55 3C F0 AA 55 3C F0 AA 55 3C F0 AA 55 3C F0	9		Y	CRC Error(SC),Fixed Stuff Error
4	2.310736	FD Data	00000000	C	00 00	8		Y	CRC Error(SC),Fixed Stuff Error
5	2.962736	FD Data	1FFFFFFF	C	FF FF FF FF FF FF FF FF	7		Y	CRC Error(SC),Fixed Stuff Error

Analysis number

When the CAN FD standard is set to non-ISO

No.	Time(ms)	Frame	ID	DLC	Data	CRC	Ack	Information
0	-0.001272	FD Data	00000000	4	00 00 00 00	18A5C	Y	
1	0.610728	FD Data	1FFFFFFF	4	FF FF FF FF	04B52	Y	CRC Error
2	0.712040	Error						
3	1.042728	FD Data	15555555	C	55 AA C3 0F 55 AA C3 0F 55 AA C3 0F 55 AA C3 0F 55 AA C3 0F 55 AA C3 0F	01C542	Y	
4	1.676736	FD Data	0AAAAAAA	C	AA 55 3C F0 AA 55 3C F0 AA 55 3C F0 AA 55 3C F0 AA 55 3C F0 AA 55 3C F0	1240DF	Y	
5	2.310736	FD Data	00000000	C	00 00	10256D	Y	

Turns zoom linking on or off

Zoom Link
OFF ON

List size and display position

List Size
Half (Upper)

Analysis number

Push List No. 0

Data before the trigger position (on the left side of the waveform display) is assigned analysis numbers in descending order (-1, -2, and so on). Data after the trigger position (on the right side of the waveform display) is assigned analysis numbers in ascending order (0, 1, 2, and so on).

Search Setup (Search)

Press the **Search** soft key. The following menu items appear.

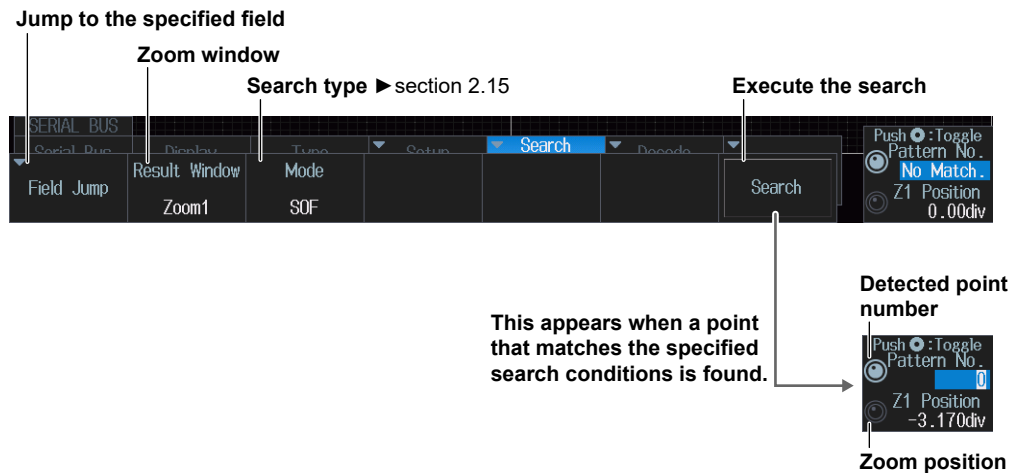

Jumping to the Specified Field (Field Jump)

Jumps to the field in the data frame that corresponds to the specified detected point number (Pattern No).

Zoom Windows (Result Window)

You can configure zoom windows Zoom1 and Zoom2 when they are displayed. Zoom1 is automatically displayed during the automatic setup of the analysis settings.

Search Type (Mode)

You can set this setting in the same way that you set the trigger mode to SOF, Error, ID/Data, FDF, and ESI (ErrorPassive). For details, see section 2.15.

Executing a Search (Search)

1. Set the search type.
2. Press the **Search** soft key.

The instrument searches for the search conditions. If the instrument finds points that match the search conditions (detected points), it shows numbers (0, 1, 2, etc.) from the left of the waveform display in the order that the points were detected.

Detected Point Number (Pattern No.)

You can set the detected point number and display the waveform for the detected point on the zoom window.

Zoom Position (Z1 Position/Z2 Position)

You can change the zoom position, which is the point on the waveform that is zoomed in on.

12.4 Analyzing and Searching LIN Bus Signals (Option)

This section explains the following settings for analyzing or searching LIN bus signals:

- Turning analysis and search displays on or off
- Serial bus signal types
- Bus setup
 - Auto setup, analysis/search source waveform, bit rate, revision, sample point, level used to detect analysis/search source waveform states, hysteresis
- Decoded display
- List display
 - List size, display position, and zoom linking
- Zoom position
- Analysis number
 - Jumping to the specified field, zoom window, search type, and search execution

► [“Analyzing and Searching Serial Bus Signals”](#) and [“Analyzing and Searching LIN Bus Signals \(Option\)”](#) in the Features Guide

SERIAL BUS LIN Menu

1. Press **SHIFT+SEARCH** (SERIAL BUS). The SERIAL BUS menu appears.
 - You can also tap **MENU** (E) in the upper left of the screen and select the SERIAL BUS menu from ANALYSIS on the top menu that is displayed.
 - You can also press **ANALYSIS** and then the **To SERIAL BUS** soft key to display the SERIAL BUS menu.
 - The instrument can analyze and search the waveforms of up to four serial bus signals. To switch the setup menu, press the **Serial Bus** soft key and select a number from 1 to 4.
2. Press the **Type** soft key. Select **LIN** from the setup menu that is displayed. The following menu items appear.

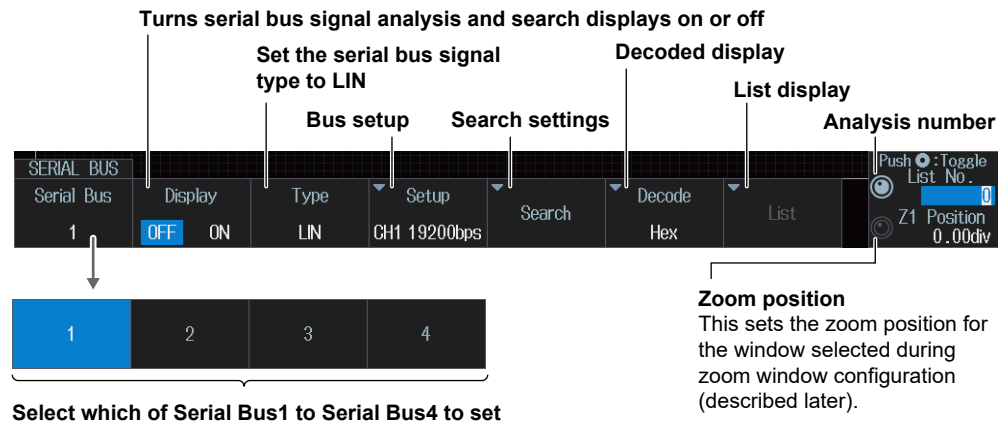

Bus Setup (Setup)

Note

Using the CH4 Terminal and Logic Signal Input Port

If you perform an analysis or execute a search when using the logic signal input ports for input, you cannot specify CH4 as the source. Press CH4 in advance to enable input from the CH4 terminal.

Press the **Setup** soft key. The following menu items appear.

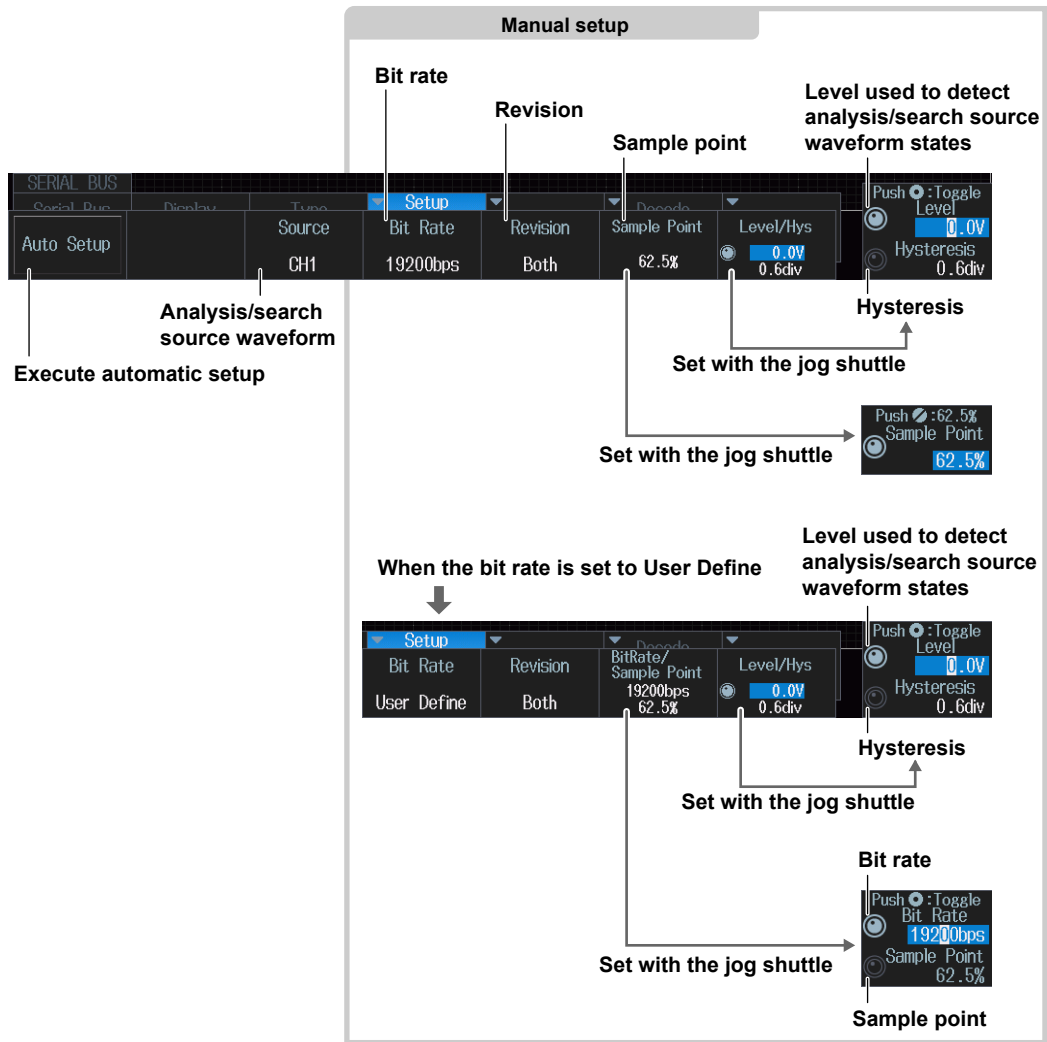

Auto Setup (Auto Setup)

1. Set the source waveform for search/analysis.
Auto setup cannot be performed when the source is set to Math1 to Math4.
2. Press the **Auto Setup** soft key.
The instrument will perform auto setup.
The instrument automatically configures the bit rate, revision, sample point, level, and hysteresis and triggers on the LIN bus signal's Break Synch.

While the serial bus is being configured, Auto Setup changes to Abort. If you want to stop, press the **Abort** soft key.

The auto setup feature will not work properly on some input signals.

Manual Setup

After running auto setup, you can change the following settings and display decoded results.

- Analysis/search source waveform
- Bit rate
- Revision
- Sample point
- Level used to detect analysis/search source waveform states
- Hysteresis

Decoded Display (Decode)

Press the **Decode** soft key. The following menu items appear.

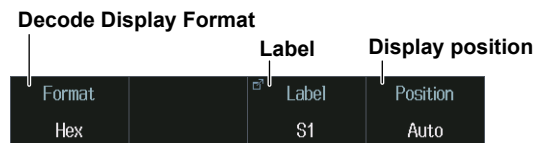

When the display position is set to Manual



Decode Display Format (Format)

Select the decode display format.

Label (Label)

Select the decode displayed label.

Display Position (Position)

Set the display position of decoded results. The position is set to Auto when you execute auto setup on the analysis menu of each serial bus signal. The position changes from Auto to Manual when you drag the decode display.

List Display (List)

1. Press the **Display** soft key and turn on the analysis and search displays.
2. Press the **List** soft key.
 - The list of analysis results and the next menu appear.
 - If several display settings of Serial Bus 1 to 4 are on, all the lists of analysis results of the serial buses whose display setting is on are displayed. For details, see section 12.12.

List of analysis results

No.	Time(ms)	ID	ID-Field	Data	Checksum	Information
0	-2.664	26	A6	00 00	FF	
1	28.984	30	F0	2D 0A	C8	
2	59.832	26	A6	00 00	FF	
3	91.080	30	F0	30 0A	C5	
4	122.328	26	A6	00 00	FF	
5	153.576	30	F0	34 0A	C1	
6	184.824	26	A6	00 00	FF	
7	216.072	30	F0	38 0A	BD	
8	247.320					

Analysis number

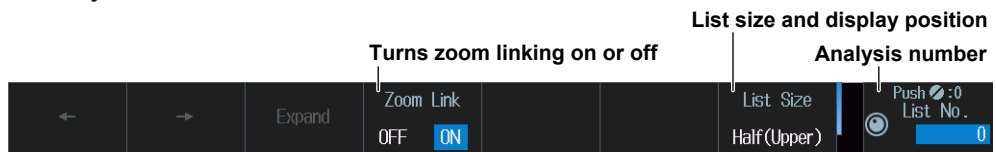

Data before the trigger position (on the left side of the waveform display) is assigned analysis numbers in descending order (-1, -2, and so on). Data after the trigger position (on the right side of the waveform display) is assigned analysis numbers in ascending order (0, 1, 2, and so on).

Search Setup (Search)

Press the **Search** soft key. The following menu items appear.

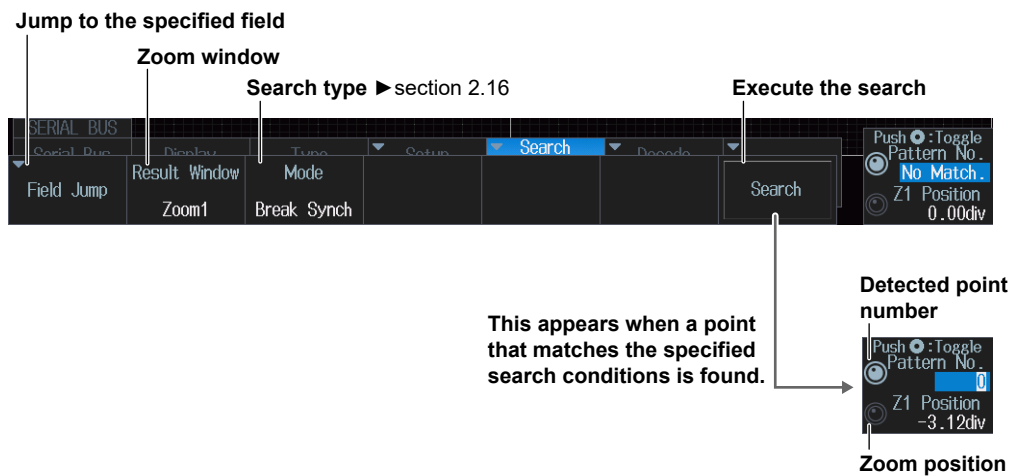

Jumping to the Specified Field (Field Jump)

Jumps to the field in the frame that corresponds to the specified detected point number (Pattern No.).

Zoom Windows (Result Window)

You can configure zoom windows Zoom1 and Zoom2 when they are displayed. Zoom1 is automatically displayed during the automatic setup of the analysis settings.

Search Type (Mode)

You can set this setting in the same way that you set the trigger mode to Break Synch, Error, or ID/Data. For details, see section 2.16.

Executing a Search (Search)

1. Set the search type.
2. Press the **Search** soft key.

The instrument searches for the search conditions. If the instrument finds points that match the search conditions (detected points), it shows numbers (0, 1, 2, etc.) from the left of the waveform display in the order that the points were detected.

Detected Point Number (Pattern No.)

You can set the detected point number and display the waveform for the detected point on the zoom window.

Zoom Position (Z1 Position/Z2 Position)

You can change the zoom position, which is the point on the waveform that is zoomed in on.

12.5 Analyzing and Searching CXPI Bus Signals (Option)

This section explains the following settings for analyzing or searching CXPI bus signals:

- Turning analysis and search displays on or off
- Serial bus signal types
- Bus setup
 - Auto setup, analysis/search source waveform, bit rate, T sample, clock tolerance, counter error detection, level used to detect analysis/search source waveform states, hysteresis
- Decoded display
- List display
 - List size, display position, and zoom linking
- Analysis number
- Zoom position
- Search settings
 - Zoom window, search type, and search execution

► [“Analyzing and Searching Serial Bus Signals”](#) and [“Analyzing and Searching CXPI Bus Signals \(Option\)”](#) in the Features Guide

SERIAL BUS CXPI Menu

1. Press **SHIFT+SEARCH** (SERIAL BUS). The SERIAL BUS menu appears.
 - You can also tap **MENU** (E) in the upper left of the screen and select the SERIAL BUS menu from ANALYSIS on the top menu that is displayed.
 - You can also press **ANALYSIS** and then the **To SERIAL BUS** soft key to display the SERIAL BUS menu.
 - The instrument can analyze and search the waveforms of up to four serial bus signals. To switch the setup menu, press the **Serial Bus** soft key and select a number from 1 to 4.
2. Press the **Type** soft key. Select **CXPI** from the setup menu that is displayed. The following menu items appear.

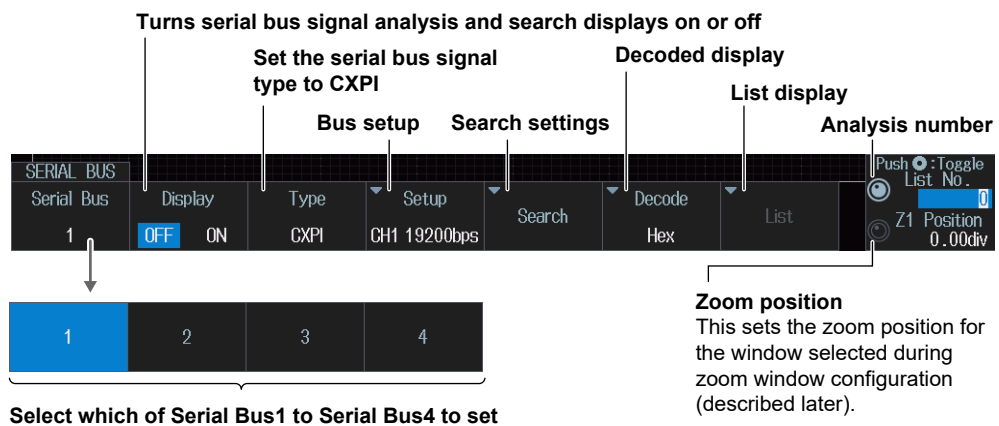

Bus Setup (Setup)

Note

Using the CH4 Terminal and Logic Signal Input Port

If you perform an analysis or execute a search when using the logic signal input ports for input, you cannot specify CH4 as the source. Press CH4 in advance to enable input from the CH4 terminal.

Press the **Setup** soft key. The following menu items appear.

Execute automatic setup

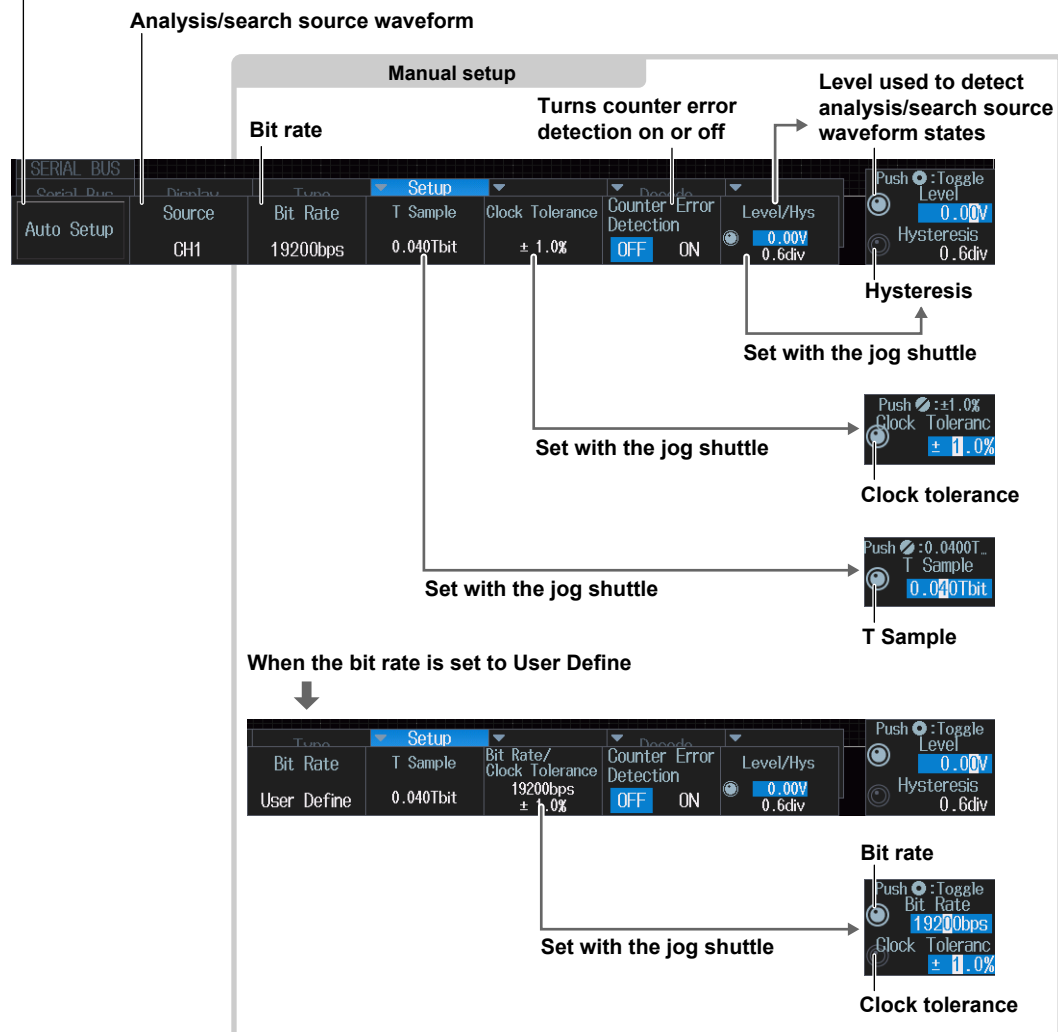

Auto Setup (Auto Setup)

1. Set the source waveform for search/analysis.
Auto setup cannot be performed when the source is set to Math1 to Math4.
2. Press the **Auto Setup** soft key.
The instrument will perform auto setup.
The instrument automatically configures the bit rate, level, and hysteresis and triggers on the start of frame (SOF) of the CXPI bus signal.

While the serial bus is being configured, Auto Setup changes to Abort. If you want to stop, press the **Abort** soft key.

The auto setup feature will not work properly on some input signals.

Manual setup

After running auto setup, you can change the following settings and display decoded results.

- Analysis/search source waveform
- Bit rate
- T Sample
- Clock tolerance
- Counter error detection
- Level used to detect analysis/search source waveform states
- Hysteresis

Decoded Display (Decode)

Press the **Decode** soft key. The following menu items appear.

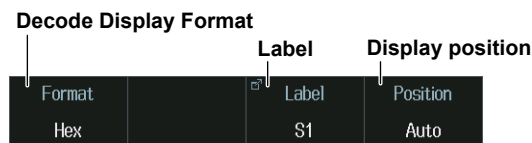

When the display position is set to Manual

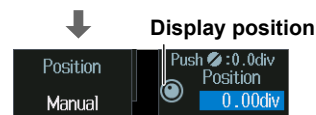

Decode Display Format (Format)

Select the decode display format.

Label (Label)

Select the decode displayed label.

Display Position (Position)

Set the display position of decoded results. The position is set to Auto when you execute auto setup on the analysis menu of each serial bus signal. The position changes from Auto to Manual when you drag the decode display.

List Display (List)

1. Press the **Display** soft key and turn on the analysis and search displays.
2. Press the **List** soft key.
 - The list of analysis results and the next menu appear.
 - If several display settings of Serial Bus 1 to 4 are on, all the lists of analysis results of the serial buses whose display setting is on are displayed. For details, see section 12.12.

List of analysis results

No.	Time(ms)	ID	DLC	W/S	CT	Data	CRC	Information
0	-0.0520	01	2	00	0	30 87		1D
1	4.3756	P0B	8	11	2	F9 2C 06 D3 4F 67 B0 98		10
2	13.5436	10	4	01	0	7D F8 82 07		F2
3	19.3256	5E	L16	00	0	A7 83 3A 68 58 7C C5 97 A7 83 3A 68 58 7C C5 97		8B6A
4	35.6296	01	2	00	1	77 8B		F7
5	40.0572	P0B	8	11	3	89 37 76 C8 23 69 DC 96		FA
6	49.2252	10	4	01	1	C7 FB 38 04		Z7
7	55.0072	5E	L16	00	1	E9 A0 0E 6A 16 5F F1 95 E9 A0 0E 6A 16 5F F1 95		B39C
8	71.3112	01	2	00	2	AE 90		12
9	75.7388	P0B	8	11	0	A6 41 59 BE F7 6A 08 95		Z8

Analysis number

List size and display position

Turns zoom linking on or off

Analysis number



Data before the trigger position (on the left side of the waveform display) is assigned analysis numbers in descending order (-1, -2, and so on). Data after the trigger position (on the right side of the waveform display) is assigned analysis numbers in ascending order (0, 1, 2, and so on).

Search Setup (Search)

Press the **Search** soft key. The following menu items appear.

Zoom window

Search type ▶ section 2.17

Execute the search

Detected point number

Zoom position

This appears when a point that matches the specified search conditions is found.

Zoom Windows (Result Window)

You can configure zoom windows Zoom1 and Zoom2 when they are displayed. Zoom1 is automatically displayed during the automatic setup of the analysis settings.

Search Type (Mode)

You can set SOF, PTYPE, and ID/Data in the same as you set the trigger setting. For details, see section 2.17.

Error Mode

Press the **Mode** soft key and then the **Error** soft key. The following menu items appear. The instrument searches for various errors.

Set the search type to Error

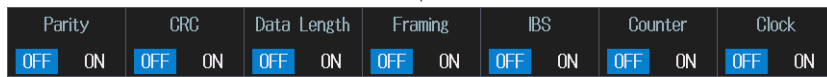
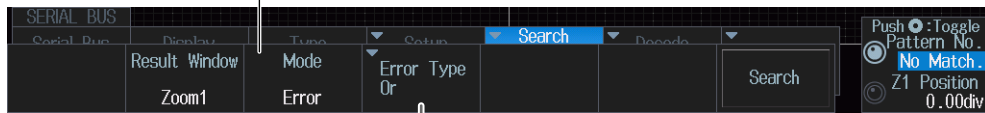

Turns on or off the detection of parity, CRC, data length, framing, IBS, counter,* and clock errors

* Not displayed when counter error detection (Counter Error Detection) in the bus setup (Setup) (page 12-18) is set to OFF.

Wakeup/Sleep mode

Press the **Mode** soft key and then the **Wakeup/Sleep** soft key. The following menu items appear. The instrument searches for wakeup pulses, wakeup states, sleep frames, or sleep states.

Set the search type to Wakeup/Sleep

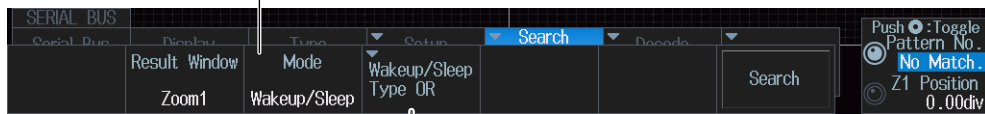

Turns on or off the detection of wakeup pulses, wakeup states, sleep frames, or sleep states

Executing a Search (Search)

1. Set the search type.
2. Press the **Search** soft key.

The instrument searches for the search conditions. If the instrument finds points that match the search conditions (detected points), it shows numbers (0, 1, 2, etc.) from the left of the waveform display in the order that the points were detected.

Detected Point Number (Pattern No.)

You can set the detected point number and display the waveform for the detected point on the zoom window.

Zoom Position (Z1 Position/Z2 Position)

You can change the zoom position, which is the point on the waveform that is zoomed in on.

12.6 Analyzing and Searching SENT Signals (Option)

This section explains the following settings (which are used when analyzing or searching SENT signals):

- Turning analysis and search displays on or off
- Serial bus signal types
- Bus setup
 - Auto setup, analysis/search source waveform, format, display channel, Fast CH data type, slow CH message type, the level used to detect the source state, and hysteresis
- Decoded display
- List display
 - List size, display position, and zoom linking
- Trend display
 - Display source, user data, display setup, turns cursor measurement on or off, message ID
- Analysis number
- Zoom position
- Search settings
 - Zoom window, search type, and search execution

► [“Analyzing and Searching Serial Bus Signals”](#) and [“Analyzing and Searching SENT Signals \(Option\)”](#) in the Features Guide

SERIAL BUS SENT Menu

1. Press **SHIFT+SEARCH** (SERIAL BUS). The SERIAL BUS menu appears.
 - You can also tap **MENU** (MENU) in the upper left of the screen and select the SERIAL BUS menu from ANALYSIS on the top menu that is displayed.
 - You can also press **ANALYSIS** and then the **To SERIAL BUS** soft key to display the SERIAL BUS menu.
 - The instrument can analyze and search the waveforms of up to four serial bus signals. To switch the setup menu, press the **Serial Bus** soft key and select a number from 1 to 4.
2. Press the **Type** soft key. Select **SENT** from the setup menu that is displayed. The following menu items appear.

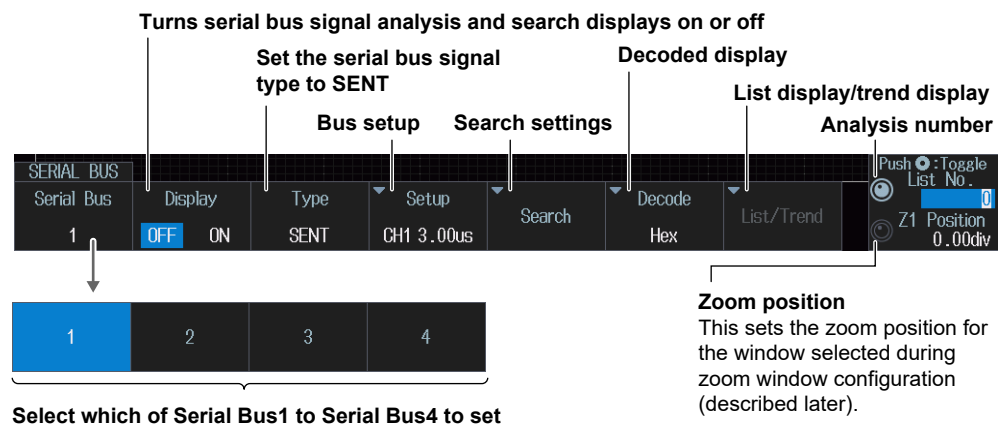

Bus Setup (Setup)

Note

Using the CH4 Terminal and Logic Signal Input Port

When you perform an analysis or execute a search, you cannot use the CH4 terminal and the logic signal input port as the source at the same time. Specify the source that you want to use in advance by pressing either CH4 or LOGIC.

Press the **Setup** soft key. The following menu items appear.

Auto Setup (Auto Setup)

Execute automatic setup

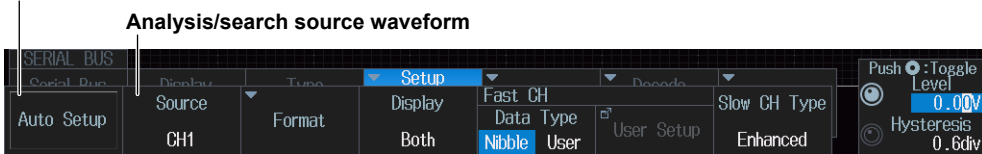

When the analysis/search source is LOGIC

(On models with the logic signal input port)

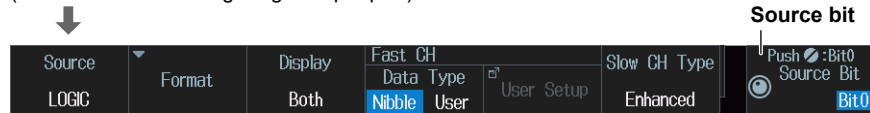

1. Set the source waveform for search/analysis. If you select LOGIC, set the source bit (Bit0 to Bit7).

You cannot use auto setup under the following circumstances.

- When the Analysis/Search Source Waveform Is Math1 to Math4
- When state display is applied to a LOGIC bit that is set as the analysis/search source waveform.

2. Press the **Auto Setup** soft key.

The instrument will perform auto setup.

The auto setup feature automatically configures the format, level, and hysteresis and then triggers at the end of S&C of the fast channel.

While the serial bus is being configured, Auto Setup changes to Abort. If you want to stop, press the **Abort** soft key.

The auto setup feature will not work properly on some input signals.

Manual setup

After running auto setup, you can change the following settings and display decoded results.

- Analysis/search source waveform
- Format
- Display channel
- Fast channel data type
- Fast channel user data type
- Slow channel message type
- Level used to detect analysis/search source waveform states
- Hysteresis

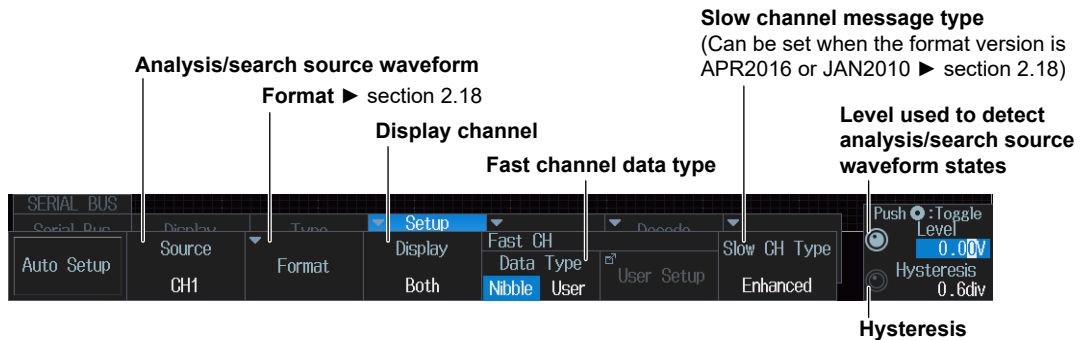

When the fast channel data type is User

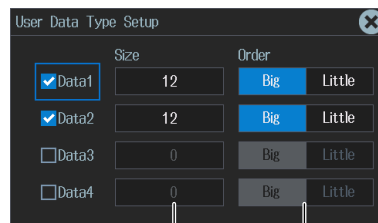
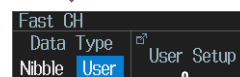

Nibble order

Data size¹

Select the check boxes for the items that you want to use as comparison conditions

When the version is APR2016



Select this check box in the case of a multiplexed signal²

- 1 The total number of bits for Data1 to Data4 is up to 24. If you try to exceed the total number of bits, the data size of other pieces of Data is reduced.
- 2 When the check box for Multiplexing is selected, the Size of Data1 is fixed to 4 to correspond to FC.

When the analysis/search source is LOGIC

(On models with the logic signal input port)

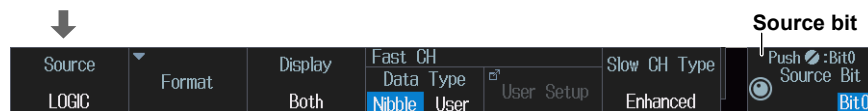

Decoded Display (Decode)

Press the **Decode** soft key. The following menu items appear.

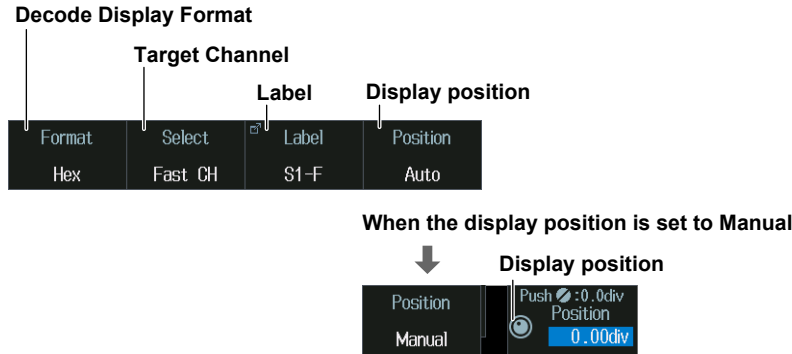

Decode Display Format (Format)

Select the decode display format.

Target Channel (Select)

Select the channel that you want to set the label and display position of.

Label (Label)

Select the decode displayed label.

Display Position (Position)

Set the display position of decoded results. The position is set to Auto when you execute auto setup on the analysis menu of each serial bus signal. The position changes from Auto to Manual when you drag the decode display.

List Display (List/Trend - List)

1. Press the **Display** soft key and turn on the analysis and search displays.
2. Press the **List/Trend** soft key and then the **List** soft key.
 - The list of analysis results and the next menu appear.
 - If several display settings of Serial Bus 1 to 4 are on, all the lists of analysis results of the serial buses whose display setting is on are displayed. For details, see section 12.12.

List of analysis results

No.	Time(us)	Sync(us)	Tick(us)	S&C	Data	DRC	Length(tick)	Information	SlowCH
0	-0.204000	168.00	3.00	0000	E B 4 4 2 1	F	284.00		
1	0.648000	168.00	3.00	0100	E B 0 4 3 1	0	284.00		
2	1.500000	168.00	3.00	0100	E A C 4 4 1	A	284.00		
3	2.352000	168.00	3.00	0100	E A 8 4 5 1	5	284.00		
4	3.204000	168.00	3.00	1100	E A 4 4 6 1	9	284.00		
5	4.056000	168.00	3.00	1000	E 9 C 4 7 1	3	284.00		

Analysis number

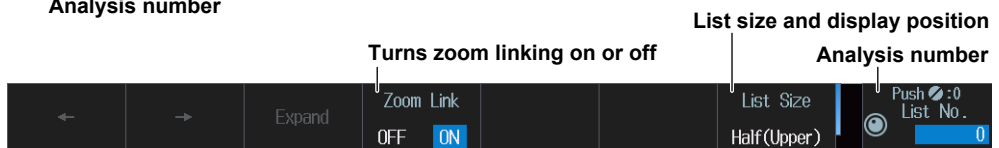

Data before the trigger position (on the left side of the waveform display) is assigned analysis numbers in descending order (-1, -2, and so on). Data after the trigger position (on the right side of the waveform display) is assigned analysis numbers in ascending order (0, 1, 2, and so on).

Trend Display (List/Trend - Trend)

1. Press the **Display** soft key and turn on the analysis and search displays.
2. Press the **List/Trend** soft key and then the **Trend** soft key.
 - The following menu items appear.
 - Up to four trends can be displayed. To switch the setup menu, press the **Trend** soft key and select a number from 1 to 4.

When the Display Source Is Set to Fast Channel

Turn the trend display on or off

Set the display source to Fast CH.

User Data Display setup Turns cursor measurement on or off

Select which trend to set from Trend1 to Trend4

When cursor measurement is on

Cursor 1 position

Cursor 2 position

When Multiplexing* is on

User Data@FC

Data1(FC)

* In the Fast CH data type settings, select the check box for Multiplexing. For details, see page 12-24.

When the Display Source Is Set to Slow Channel

Turn the trend display on or off

Set the display source to Slow CH.

Display setup

Turns cursor measurement on or off

Message ID

When cursor measurement is on

Set with the jog shuttle

Set with the jog shuttle

Cursor 1 position

Cursor 2 position

Select which trend to set from Trend1 to Trend4

Message ID (Slow CH ID)

Set the message ID of the data you want to display the trend of. The selectable ID range varies depending on the decode display setting in the SERIAL BUS_SENT Menu (page 12-25), Version under Format in the bus setup (Setup) (page 12-26), and the slow channel message type in the bus setup.

Version	FEB2008 and older			
	APR2016, JAN2010			
Slow channel message type	Short		Enhanced	
Decode display setting	Hex	Dec	Hex	Dec
Selectable range	0 to F	0 to 15	00 to FF	0 to 255

Configuring the Display (Display Setup)

Press the **Display Setup** soft key. The following menu items appear.

Execute auto scaling

Range to display the trend of

Turn the VT waveform display on or off

Vertical scale of the trend display

Executing Automatic Scaling (Auto Scale Exec)

Press the **Auto Scale Exec** soft key.

The upper and lower limits are set so that the difference between the maximum data value and minimum data value in the window selected with H-Range covers 80% of the vertical scale of the Trend window.

Search Setup (Search)

Press the **Search** soft key. The following menu items appear.

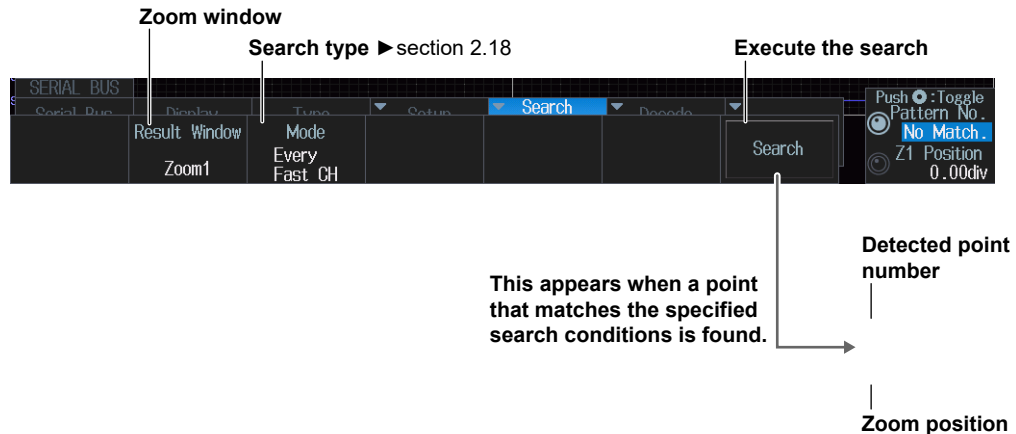

Zoom Windows (Result Window)

You can configure zoom windows Zoom1 and Zoom2 when they are displayed. Zoom1 is automatically displayed during the automatic setup of the analysis settings.

Search Type (Mode)

This is the same as setting trigger mode Every Fast CH, Fast CH S&C, Fast CH Data, Every Slow CH, Slow CH ID/Data, and Error. For details, see section 2.18.

However, the following setting methods differ.

- If the search type is Fast CH Data mode, set the data type (Data Type) using Data Type in Fast CH in bus setup (Setup) (page 12-27).
- If the search type is Every Slow CH mode or Slow CH ID/Data mode, the Slow CH message type (Slow CH Type) is set using Slow CH Type (Slow CH Type) in bus setup (Setup) (page 12-27)).
- If the search type is Slow CH ID/Data mode, the input format (Hex/Dec) of the reference values a and b of ID/Data of Condition Setup is changed by the decode display (Decode) setting of SEARCH SENT menu (page 12-25).

Executing a Search (Search)

1. Set the search type.
2. Press the **Search** soft key.

The instrument searches for the search conditions. If the instrument finds points that match the search conditions (detected points), it shows numbers (0, 1, 2, etc.) from the left of the waveform display in the order that the points were detected.

Detected Point Number (Pattern No.)

You can set the detected point number and display the waveform for the detected point on the zoom window.

Zoom Position (Z1 Position/Z2 Position)

You can change the zoom position, which is the point on the waveform that is zoomed in on.

12.7 Analyzing and Searching PSI5 Airbag Signals (Option)

This section explains the following settings for analyzing or searching PSI5 Airbag signals:

- Turning analysis and search displays on or off
- Serial bus signal types
- Bus setup
 - Auto setup, sync signal, data frame source, bit rate, data length, error detection method, sync noise rejection, clock tolerance, and the level and hysteresis used to detect the sync signal or data frame source state
- Decoded display
- List display
 - List size, display position, and zoom linking
- Trend Display
 - Display source, display settings, cursor measurement on/off, auto scale
- Analysis number
- Zoom position
- Search settings
 - Zoom window, search type, and search execution

► [“Analyzing and Searching Serial Bus Signals”](#) and [“Analyzing and Searching PSI5 Airbag Signals \(Option\)”](#) in the Features Guide

SERIAL BUS PSI5 Airbag Menu

1. Press **SHIFT+SEARCH** (SERIAL BUS). The SERIAL BUS menu appears.
 - You can also tap **MENU** (☰) in the upper left of the screen and select the SERIAL BUS menu from ANALYSIS on the top menu that is displayed.
 - You can also press **ANALYSIS** and then the **To SERIAL BUS** soft key to display the SERIAL BUS menu.
 - The instrument can analyze and search the waveforms of up to four serial bus signals. To switch the setup menu, press the **Serial Bus** soft key and select a number from 1 to 4.
2. Press the **Type** soft key. Select **PSI5 Airbag** from the setup menu that is displayed. The following menu items appear.

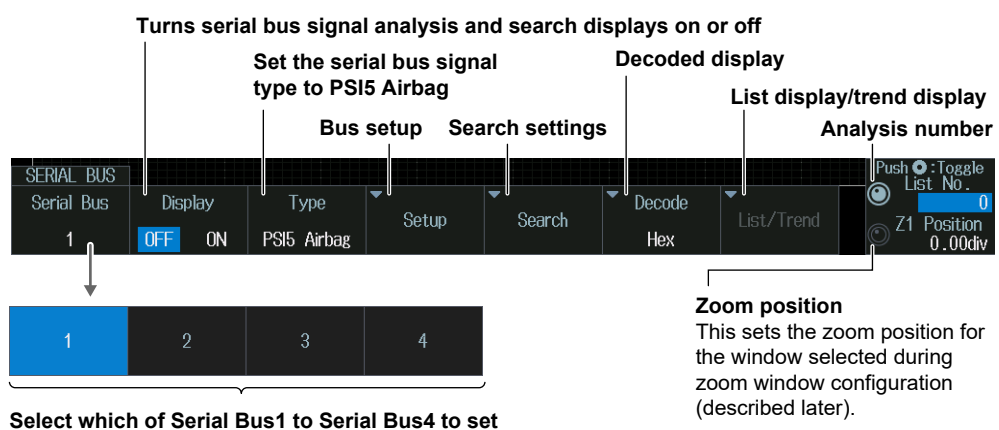

Bus Setup (Setup)

Note

Using the CH4 Terminal and Logic Signal Input Port

When you perform an analysis or execute a search, you cannot use the CH4 terminal and the logic signal input port as the source at the same time. Specify the source that you want to use in advance by pressing either CH4 or LOGIC.

Press the **Setup** soft key. The following menu items appear.

Auto Setup (Auto Setup)

Executes auto setup

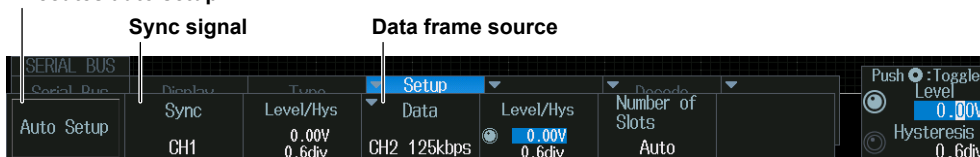

When the sync signal is set to None



1. Set the sync signal.
 - You cannot use auto setup under the following circumstances.
 - Auto setup cannot be performed when the source is set to Math1 to Math4.
 - If you select None, sync signal is not detected. Therefore, sync signal noise rejection is set to OFF.
2. Set the data frame source.
 - Auto setup cannot be performed when the source is set to Math1 to Math4.
3. Press the **Auto Setup** soft key.
 - The instrument will perform auto setup.
 - Bit rate, data length, error detection method, sync signal noise rejection, clock tolerance, number of slots, level, and hysteresis are set automatically.
 - When the sync signal (Sync) source is CH1 to CH4, the instrument triggers on the rising edge of the sync pulse. When the sync signal source is None, the instrument triggers on the start bit of data frames.

While the serial bus is being configured, Auto Setup changes to Abort. If you want to stop, press the **Abort** soft key.

The auto setup feature will not work properly on some input signals.

Manual setup

After running auto setup, you can change the following settings and display decoded results.

- Sync signal
- Level for detecting sync signal states/hysteresis
- Data frame source
- Level for detecting data frame source states/hysteresis
- Number of slots

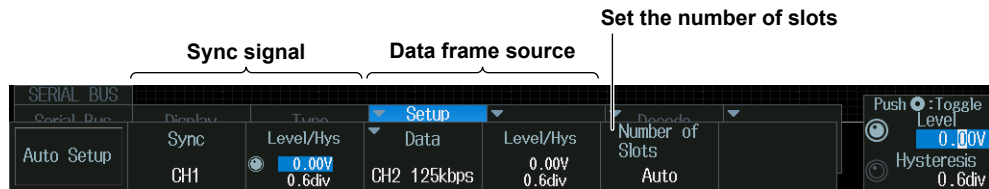

Sync Signal (Sync)

Press the **Sync** soft key. A menu appears according to the sync signal you specified.

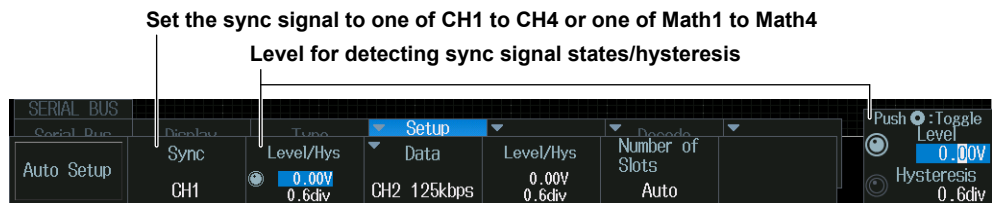

When the sync signal is set to None

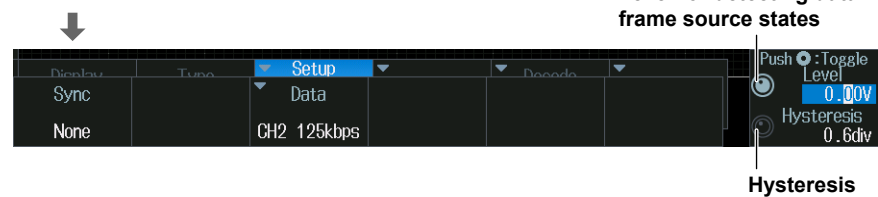

Data Frame Source (Data)

Press the **Data** soft key. The following menu items appear.

Set the data frame source.

Bit rate
Data length
Error detection method
Fixed to CRC when the data length is 16 bit
Clock tolerance

Mode: OFF ON
Sync Noise Rejection: 44.0us
Push: ±5.0% Clock Tolerance ±5.0%

Sync noise rejection end

When the bit rate is set to User Define

Bit rate
Clock tolerance

Bit Rate: User Define
Data Bits: 10bit 16bit
Error Detection: Parity CRC
Sync Noise Rejection: 44.0us
Push: Toggle Bit Rate 125.0kbps
Clock Tolerance: 5.0%

Number of Slots (Number of Slots)

Press the **Number of Slots** soft key. The following menu items appear.

Set the start position to slot 6.
Set the start position to slot 5.
Set the start position to slot 4.
Set the start position to slot 3.
Set the start position to slot 2.
Set the start position to slot 1.
Set the start position automatically.

When the number of slots is set to for 1 to 6

Set the number of slots to 1.
Setting the time range of each slot

Set the start position.
Set the end position.

Slot 1 Start: 44.0us
Slot 1 End: 181.3us
Push: 44.0us Slot 1 Start
Push: 181.3us Slot 1 End

Decoded Display (Decode)

Press the **Decode** soft key. The following menu items appear.

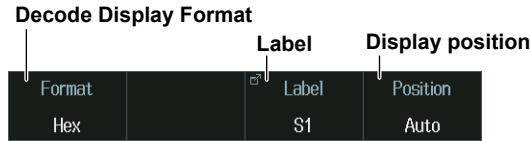

When the display position is set to Manual



Decode Display Format (Format)

Select the decode display format.

Label (Label)

Select the decode displayed label.

Display Position (Position)

Set the display position of decoded results. The position is set to Auto when you execute auto setup on the analysis menu of each serial bus signal. The position changes from Auto to Manual when you drag the decode display.

List Display (List/Trend - List)

1. Press the **Display** soft key and turn on the analysis and search displays.
2. Press the **List/Trend** soft key and then the **List** soft key.
 - The list of analysis results and the next menu appear.
 - If several display settings of Serial Bus 1 to 4 are on, all the lists of analysis results of the serial buses whose display setting is on are displayed. For details, see section 12.12.

List of analysis results

No.	Time(ms)	Frame	ID	DLC	Data	CRC	Ack	Information
0	-0.095	Data	100	3	FF 01 A4	6D6E	Y	
1	2.579	Data	00A	2	01 02	4A24	Y	
2	5.091	Data	012	1	FE	2263	Y	
3	7.531	Data	100	3	FF 01 A4	6D6E	Y	
4	10.115	Data	00A	2	01 02	4A24	Y	
5	12.627	Data	012	1	FE	2263	Y	
6	15.067	Data	100	3	FF 01 A4	6D6E	Y	
7	17.939	Error						
8	20.163	Data	00A	2	01 02	4A24	Y	
9	22.676	Data	012	1	FE	2263	Y	
10	25.115	Data	100	3	FF 01 A4	6D6E	Y	
11	27.699	Data	00A	2	01 02	4A24	Y	

Analysis number

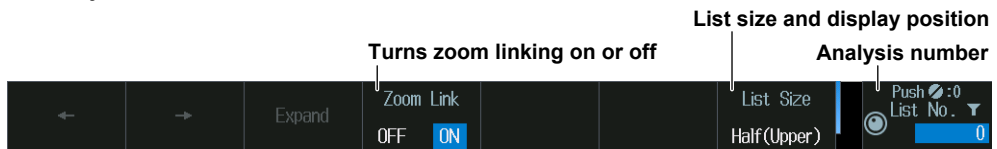

Data before the trigger position (on the left side of the waveform display) is assigned analysis numbers in descending order (-1, -2, and so on). Data after the trigger position (on the right side of the waveform display) is assigned analysis numbers in ascending order (0, 1, 2, and so on).

Trend Display (List/Trend - Trend)

1. Press the **Display** soft key and turn on the analysis and search displays.
2. Press the **List/Trend** soft key and then the **Trend** soft key.
 - The following menu items appear.
 - Up to four trends can be displayed. To switch the setup menu, press the **Trend** soft key and select a number from 1 to 4.

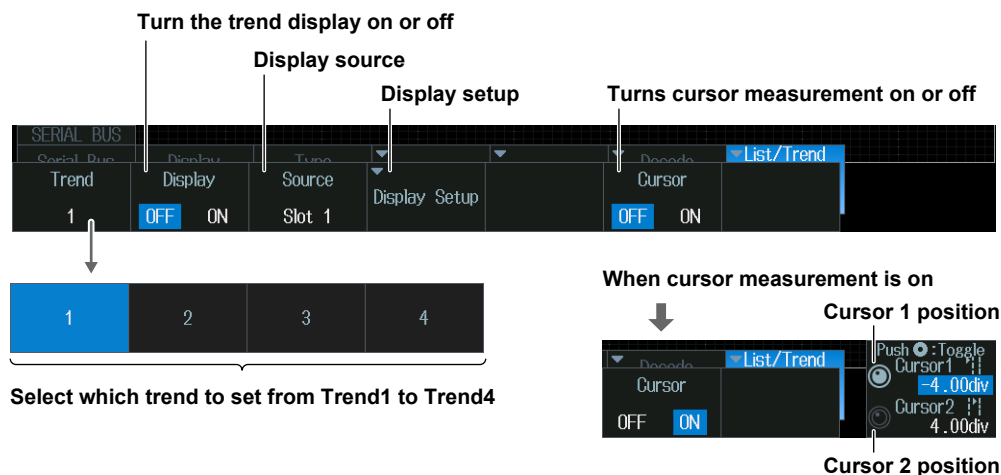

Configuring the Display (Display Setup)

Press the **Display Setup** soft key. The following menu items appear.

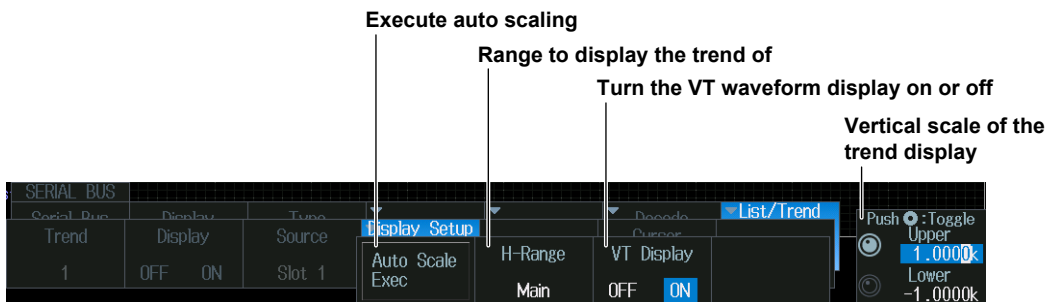

Executing Automatic Scaling (Auto Scale Exec)

Press the **Auto Scale Exec** soft key.

The upper and lower limits are set so that the difference between the maximum data value and minimum data value in the window selected with H-Range covers 80% of the vertical scale of the Trend window.

Search Setup (Search)

Press the **Search** soft key. The following menu items appear.

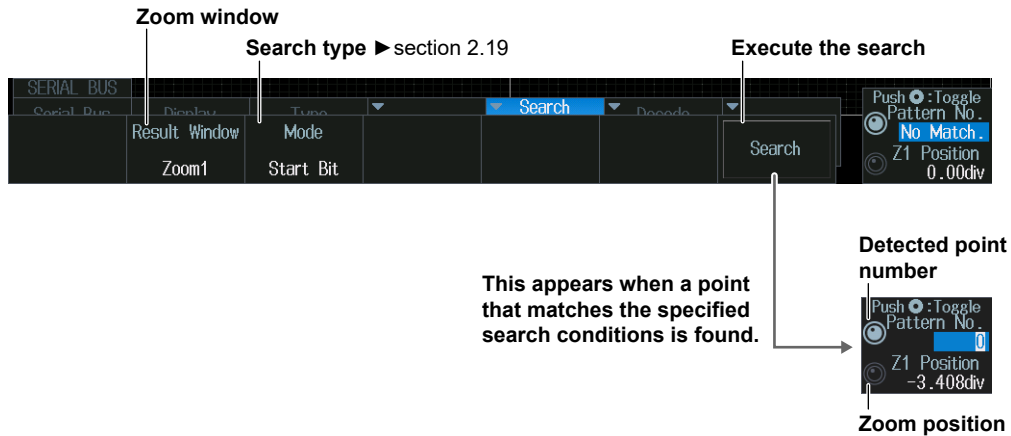

Zoom Windows (Result Window)

You can configure zoom windows Zoom1 and Zoom2 when they are displayed. Zoom1 is automatically displayed during the automatic setup of the analysis settings.

Search Type (Mode)

This is the same as setting trigger mode Sync, Start Bit, Frame in Slot, Data, and Error. For details, see section 2.19.

Sync mode and Frame in Slot mode will not be available if the bus sync signal (Sync) is set to None.

Executing a Search (Search)

1. Set the search type.
2. Press the **Search** soft key.

The instrument searches for the search conditions. If the instrument finds points that match the search conditions (detected points), it shows numbers (0, 1, 2, etc.) from the left of the waveform display in the order that the points were detected.

Detected Point Number (Pattern No.)

You can set the detected point number and display the waveform for the detected point on the zoom window.

Zoom Position (Z1 Position/Z2 Position)

You can change the zoom position, which is the point on the waveform that is zoomed in on.

12.8 Analyzing and Searching UART Signals (Option)

This section explains the following settings for analyzing or searching UART signals:

- Turning analysis and search displays on or off
- Serial bus signal types
- Bus setup
 - Auto setup, analysis/search source waveform, data format, parity, grouping, level used to detect analysis/search source waveform states, hysteresis
- Decoded display
- List display
 - List size, display position, grouping, detailed display, and zoom linking
- Analysis and data numbers
- Zoom position
- Search settings
 - Zoom window, search type, and search execution

► [“Analyzing and Searching Serial Bus Signals”](#) and [“Analyzing and Searching UART Signals \(Option\)”](#) in the Features Guide

SERIAL BUS UART Menu

1. Press **SHIFT+SEARCH** (SERIAL BUS). The SERIAL BUS menu appears.
 - You can also tap **MENU** (☰) in the upper left of the screen and select the SERIAL BUS menu from ANALYSIS on the top menu that is displayed.
 - You can also press **ANALYSIS** and then the **To SERIAL BUS** soft key to display the SERIAL BUS menu.
 - The instrument can analyze and search the waveforms of up to four serial bus signals. To switch the setup menu, press the **Serial Bus** soft key and select a number from 1 to 4.
2. Press the **Type** soft key. Select **UART** from the setup menu that is displayed. The following menu items appear.

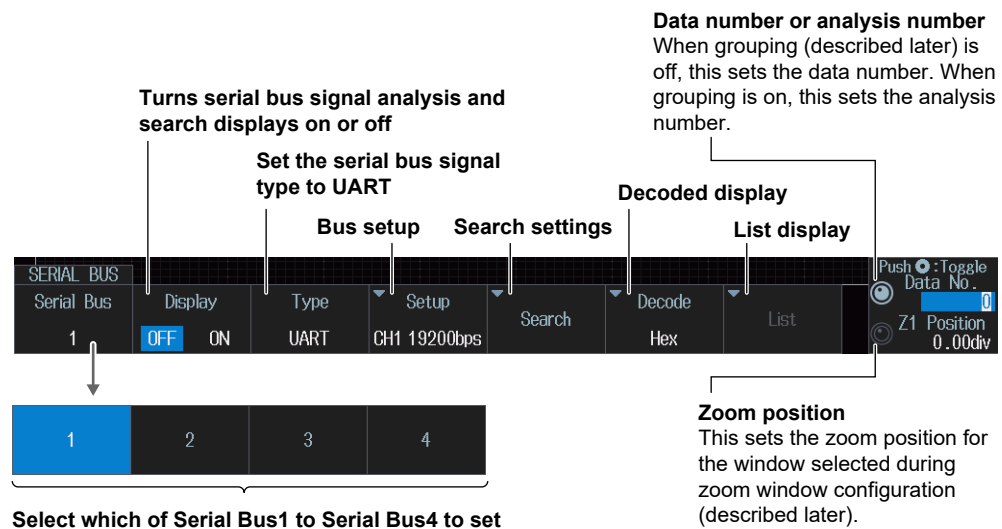

Bus Setup (Setup)

Note

Using the CH4 Terminal and Logic Signal Input Port

When you perform an analysis or execute a search, you cannot use the CH4 terminal and the logic signal input port as the source at the same time. Specify the source that you want to use in advance by pressing either CH4 or LOGIC.

Press the **Setup** soft key. The following menu items appear.

Auto Setup (Auto Setup)

Execute automatic setup

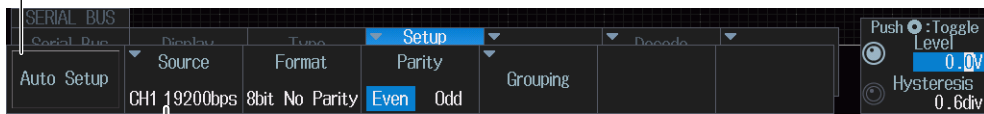

Analysis/search source waveform

When the analysis/search source is LOGIC (On models with the logic signal input port)



Source bit

1. Press the **Source** soft key.
The analysis/search source waveform setup menu is displayed.
2. Set the source waveform for search/analysis. If you select LOGIC, set the source bit (Bit0 to Bit7).
You cannot use auto setup under the following circumstances.
 - When the Analysis/Search Source Waveform Is Math1 to Math4
 - When state display is applied to a LOGIC bit that is set as the analysis/search source waveform.
3. Press **ESC**.
Returns to the bus setup menu.
4. Press the **Auto Setup** soft key.
The instrument will perform auto setup.
The instrument automatically configures the bit rate, sample point, level, and hysteresis and then triggers on the UART signal's Stop Bit.

While the serial bus is being configured, Auto Setup changes to Abort. If you want to stop, press the **Abort** soft key.

The auto setup feature will not work properly on some input signals.

Manual setup

After running auto setup, you can change the following settings and display decoded results.

- Analysis/search source waveform
- Data format
- Parity
- Grouping
- Level used to detect analysis/search source waveform states
- Hysteresis

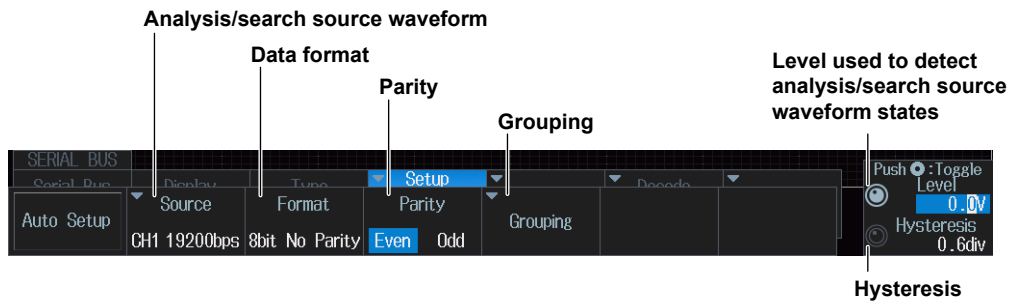

Analysis/search source waveform (Source)

Press the **Source** soft key. A menu appears according to the analysis/search source waveform you specified.

- **When the Analysis/Search Source Waveform is CH1 to CH4 or Math1 to Math4**

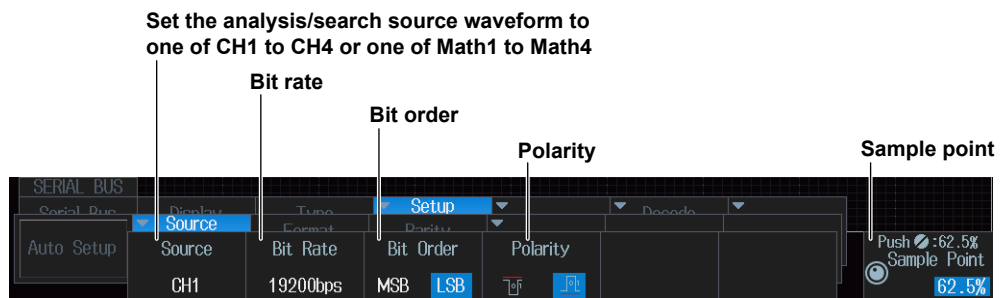

When the bit rate is set to User Define

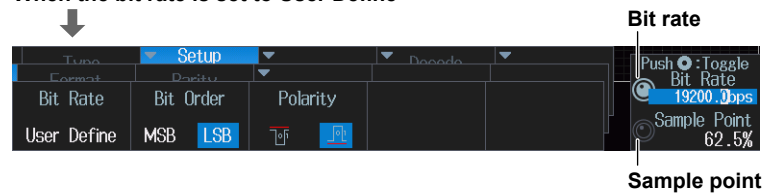

12.8 Analyzing and Searching UART Signals (Option)

- When the Analysis/Search Source Waveform Is LOGIC (On models with the logic signal input port)

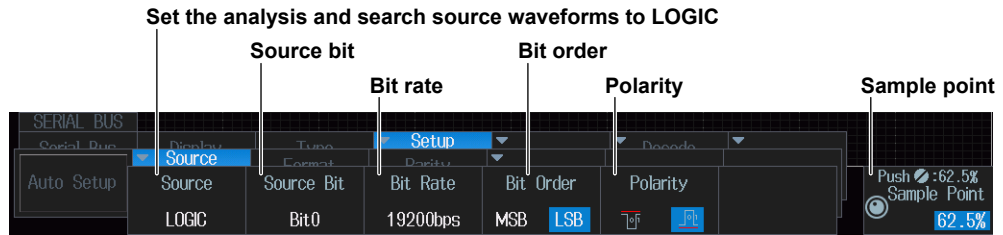

Grouping (Grouping)

Press the **Grouping** soft key. The following menu items appear.

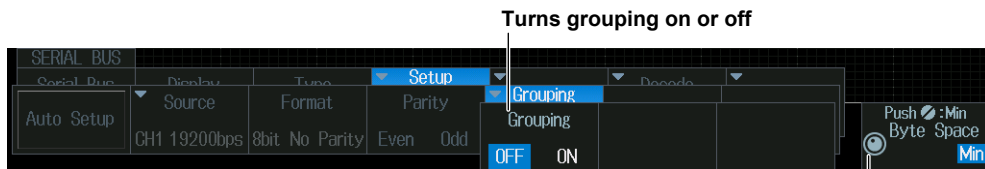

Byte space

When you turn grouping on, data whose time is shorter than the specified byte space (Byte Space) is decoded and displayed in a single group.

Decoded Display (Decode)

Press the **Decode** soft key. The following menu items appear.

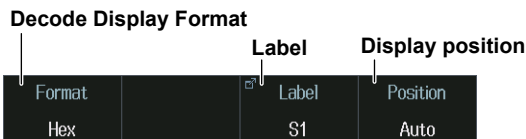

When the display position is set to Manual



Decode Display Format (Format)

Select the decode display format.

Label (Label)

Select the decode displayed label.

Display Position (Position)

Set the display position of decoded results. The position is set to Auto when you execute auto setup on the analysis menu of each serial bus signal. The position changes from Auto to Manual when you drag the decode display.

List Display (List)

1. Press the **Display** soft key and turn on the analysis and search displays.
2. Press the **List** soft key.
 - The list of analysis results and the next menu appear.
 - If several display settings of Serial Bus 1 to 4 are on, all the lists of analysis results of the serial buses whose display setting is on are displayed. For details, see section 12.12.

When Grouping Is Set to OFF

List of analysis results

Serial Bus		S1: UART															
Address	Hex															ASCII	
00000000	59 CF 4B CF 47 41 D7 41 D7 C5 C3 CF 4D C5 59															Y.K.GA.A....N.Y	
00000010	CF 4B CF 47 41 D7 41 D7 C5 C3 CF 4D C5 59 CF															.K.GA.A....N.Y.	
00000020	4B CF 47 41 D7 41 D7 C5 C3 CF 4D C5 59 CF 4B															K.GA.A....N.Y.K	
00000030	CF 47 41 D7 41 D7 C5 C3 CF 4D C5 59 CF 4B CF															.GA.A....N.Y.K.	
00000040	47 41 D7 41 D7															GA.A.	

When a framing error is detected

The * mark is appended.

When a parity error is detected

The x mark is appended.

If both a framing error and a parity error are detected

The * mark used for framing errors is appended.

The data that corresponds to the selected data number is highlighted.

Data from the leftmost side of the waveform display

Turns zoom linking on or off

Set Grouping to OFF

List size and display position

Data number



When Grouping Is Set to ON

List of analysis results

No.	Time(ms)	Data(HEX)	Data(ASCII)	Information
0	-2.7932	59 CF 4B CF 47 41 D7 41	Y.K.GA.A	
1	2.7900	D7 C5 CC C3 CF 4D C5M.	
2	7.8000	59 CF 4B CF 47 41 D7 41	Y.K.GA.A	
3	13.3832	D7 C5 CC C3 CF 4D C5M.	
4	18.3932	59 CF 4B CF 47 41 D7 41	Y.K.GA.A	
5	23.9764	D7	.	

Analysis number

If multiple errors are detected in one piece of data, the instrument only displays the framing error indication. Framing Error, Parity Error

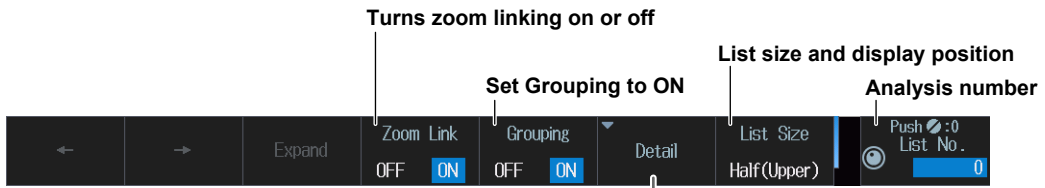

This is the list of analysis results that is displayed when you press the Detail soft key. All data for the specified analysis number is displayed.

No.	Address	Hex	ASCII
0	00000000	59 CF 4B CF 47 41 D7 41	Y.K.GA.A

The data that corresponds to the selected data number is highlighted.



The same marks are appended to the data numbers if an error is detected as when grouping is off.

Data before the trigger position (on the left side of the waveform display) is assigned analysis numbers in descending order (-1, -2, and so on). Data after the trigger position (on the right side of the waveform display) is assigned analysis numbers in ascending order (0, 1, 2, and so on).

Search Setup (Search)

Press the **Search** soft key. The following menu items appear.

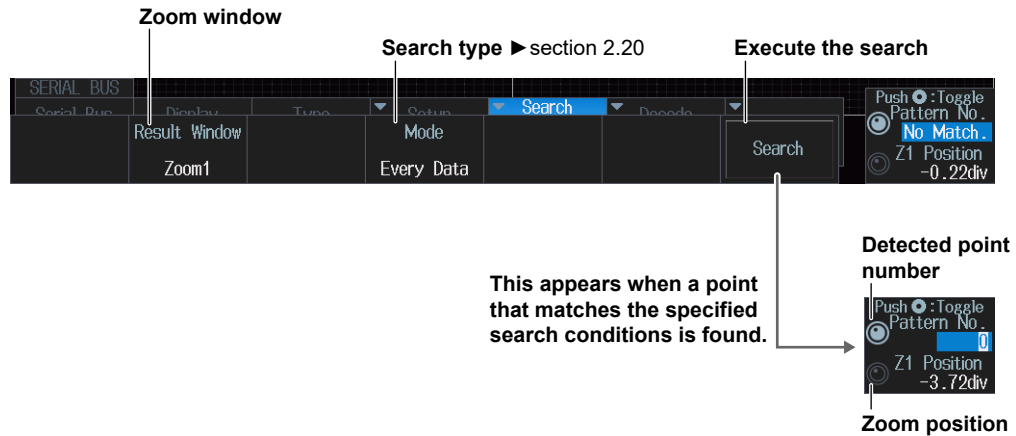

Zoom Windows (Result Window)

You can configure zoom windows Zoom1 and Zoom2 when they are displayed. Zoom1 is automatically displayed during the automatic setup of the analysis settings.

Search Type (Mode)

You can set this setting in the same way that you set the trigger mode to Every Data, Error, or Data.

For details, see section 2.20.

Executing a Search (Search)

1. Set the search type.
2. Press the **Search** soft key.

The instrument searches for the search conditions. If the instrument finds points that match the search conditions (detected points), it shows numbers (0, 1, 2, etc.) from the left of the waveform display in the order that the points were detected.

Detected Point Number (Pattern No.)

You can set the detected point number and display the waveform for the detected point on the zoom window.

Zoom Position (Z1 Position/Z2 Position)

You can change the zoom position, which is the point on the waveform that is zoomed in on.

12.9 Analyzing and Searching I²C Bus Signals (Option)

This section explains the following settings for analyzing or searching I²C bus signals:

- Turning analysis and search displays on or off
- Serial bus signal types
- Bus setup
 - Auto setup, SCL source, SDA source, the level used to detect the SCL source/SDA source states, and hysteresis
- Decoded display
- List display
 - List size, display position, detailed display, and zoom linking
- Analysis number
- Zoom position
- Search settings
 - Zoom window, search type, and search execution

► [“Analyzing and Searching Serial Bus Signals”](#) and [“Analyzing and Searching I²C Bus Signals \(Option\)”](#) in the Features Guide

SERIAL BUS I²C Menu

1. Press **SHIFT+SEARCH** (SERIAL BUS). The SERIAL BUS menu appears.
 - You can also tap **MENU** (☰) in the upper left of the screen and select the SERIAL BUS menu from ANALYSIS on the top menu that is displayed.
 - You can also press **ANALYSIS** and then the **To SERIAL BUS** soft key to display the SERIAL BUS menu.
 - The instrument can analyze and search the waveforms of up to four serial bus signals. To switch the setup menu, press the **Serial Bus** soft key and select a number from 1 to 4.
2. Press the **Type** soft key. Select **I²C** from the setup menu that is displayed. The following menu items appear.

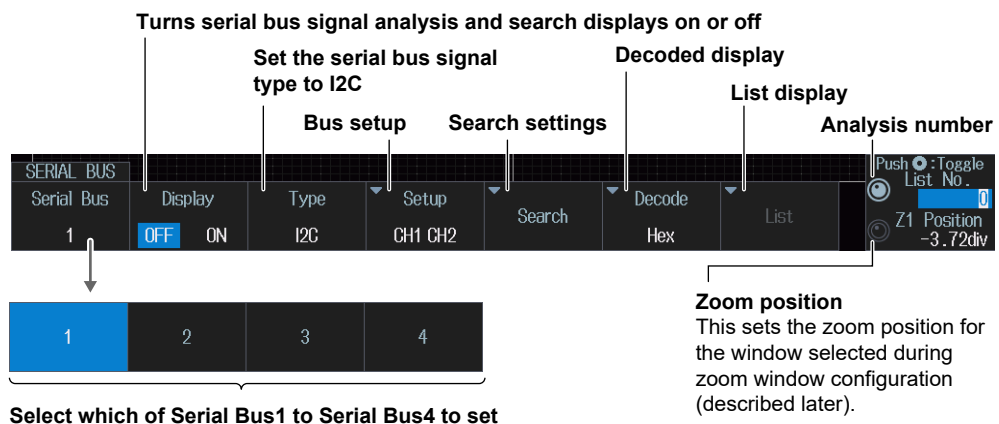

Bus Setup (Setup)

Note

Using the CH4 Terminal and Logic Signal Input Port

When you perform an analysis or execute a search, you cannot use the CH4 terminal and the logic signal input port as the source at the same time. Specify the source that you want to use in advance by pressing either CH4 or LOGIC.

Press the **Setup** soft key. The following menu items appear.

Auto Setup (Auto Setup)

Execute automatic setup

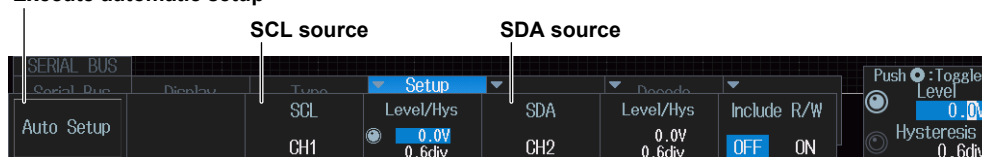

When the SCL/SDA sources are LOGIC (On models with the logic signal input port)

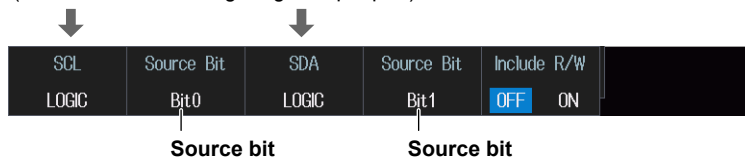

1. Set the SCL and SDA sources.

If you select LOGIC, set the source bit (Bit0 to Bit7).

You cannot use auto setup under the following circumstances.

- When the SCL or SDA source is set to Math1 to Math4
- When state display is applied to a LOGIC bit that is set as the SCL or SDA source

2. Press the **Auto Setup** soft key.

The instrument will perform auto setup.

The instrument automatically configures the level and hysteresis and triggers on the start condition of the I²C bus signal.

While the serial bus is being configured, Auto Setup changes to Abort. If you want to stop, press the **Abort** soft key.

The auto setup feature will not work properly on some input signals.

Manual Setup

After running auto setup, you can change the following settings and display decoded results.

- SCL source
- SDA source
- Level used to detect SCL source/SDA source states
- Hysteresis

When CH1 to CH4 and Math1 to Math4 Are Set as SCL Source and SDA Source

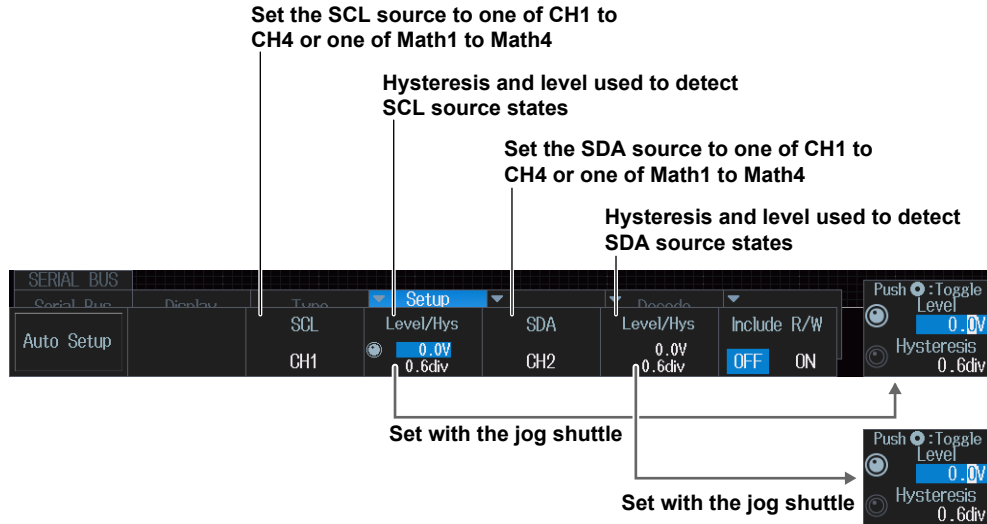

When LOGIC is set to SCL source or SDA source (On models with the logic signal input port)

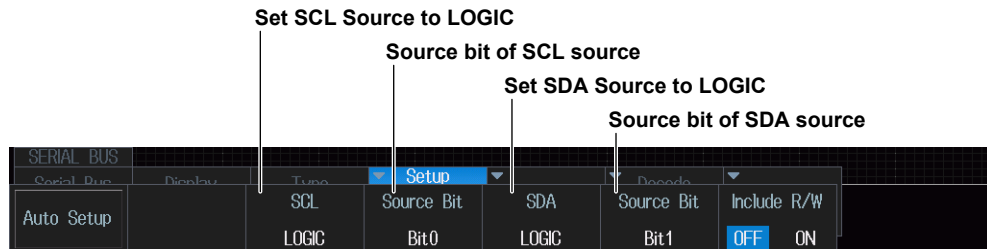

R/W Bit Inclusion (Include R/W)

Specify whether to include the R/W bit (ON) or omit it (OFF) when setting or displaying the address. This setting affects the configuration and display of the address pattern in the following situations.

- Search type when search type is Address Data (Address in the Condition Setup screen)
- Decoded display
- When the 1st and 2nd address boxes on the list display are visible

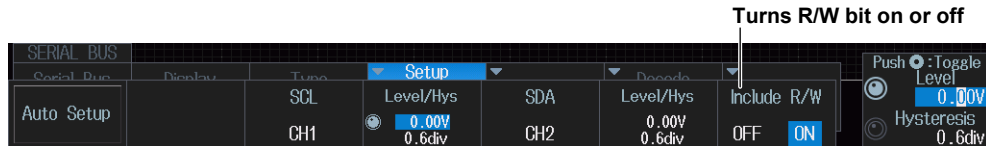

ON: Include the R/W bit when setting or displaying the address pattern.

OFF: Omit the R/W bit when setting or displaying the address pattern.

Note

R/W bit inclusion (Include R/W) can also be set by selecting I2C Bus Signal Trigger, then Trigger Mode (Mode), and then Address Data Mode. The settings are synced. For details about I2C bus signal trigger, see section 2.21.

Decoded Display (Decode)

Press the **Decode** soft key. The following menu items appear.



When the display position is set to Manual

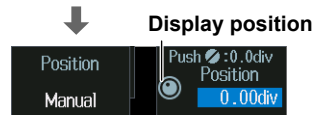

Decode Display Format (Format)

Select the decode display format.

Label (Label)

Select the decode displayed label.

Display Position (Position)

Set the display position of decoded results. The position is set to Auto when you execute auto setup on the analysis menu of each serial bus signal. The position changes from Auto to Manual when you drag the decode display.

List Display (List)

1. Press the **Display** soft key and turn on the analysis and search displays.
2. Press the **List** soft key.
 - The list of analysis results and the next menu appear.
 - If several display settings of Serial Bus 1 to 4 are on, all the lists of analysis results of the serial buses whose display setting is on are displayed. For details, see section 12.12.

List of analysis results

No.	Time (ms)	1st	2nd	R/W	Data	Information
0	0.00496	2C*		W	6E* A3*	7-bit
1	0.18896	2C*		R	6E* A3	7-bit
2	1.33296	55*		W	AE* 8B*	7-bit
3	1.51696	3A*		R	BC* EF	7-bit
4	2.66096	1C*		W	53* A9*	7-bit
5	2.84496	4E*		R	10* 4B	7-bit
6	3.98896	7C*		W	EB* 21*	7-bit
7	4.17296	4E*		R	66* E2	7-bit

Analysis number



Turns zoom linking on or off

List size and display position

Analysis number

This is the list of analysis results that is displayed when you press the **Detail** soft key. All data for the specified analysis number is displayed.

No.	Address	Hex	ASCII
0	00000000	6E* A3*	ti

The data that corresponds to the selected data number is highlighted.

Data number

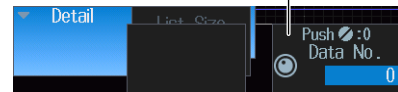

Data before the trigger position (on the left side of the waveform display) is assigned analysis numbers in descending order (-1, -2, and so on). Data after the trigger position (on the right side of the waveform display) is assigned analysis numbers in ascending order (0, 1, 2, and so on).

Search Setup (Search)

Press the **Search** soft key. The following menu items appear.

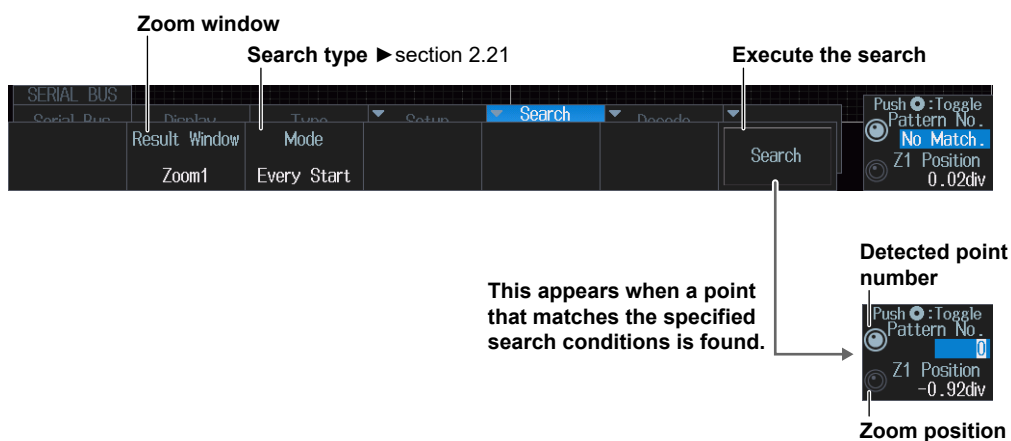

Zoom Windows (Result Window)

You can configure zoom windows Zoom1 and Zoom2 when they are displayed. Zoom1 is automatically displayed during the automatic setup of the analysis settings.

Search Type (Mode)

You can make this setting in the same way that you set the trigger mode to Every Start, Address Data, NON ACK, General Call, Start Byte, or HS Mode. For details, see section 2.21.

Executing a Search (Search)

1. Set the search type.
2. Press the **Search** soft key.

The instrument searches for the search conditions. If the instrument finds points that match the search conditions (detected points), it shows numbers (0, 1, 2, etc.) from the left of the waveform display in the order that the points were detected.

Detected Point Number (Pattern No.)

You can set the detected point number and display the waveform for the detected point on the zoom window.

Zoom Position (Z1 Position/Z2 Position)

You can change the zoom position, which is the point on the waveform that is zoomed in on.

12.10 Analyzing and Searching SPI Bus Signals (Option)

This section explains the following settings for analyzing or searching SPI bus signals:

- Turning analysis and search displays on or off
- Serial bus signal types
 - Bus setup
 - Auto setup, wiring system, clock source, data source, chip select source, and bit order
- Decoded display
- List display
 - List size, display position, detailed display, and zoom linking
- Analysis number
- Zoom position
- Search settings
 - Zoom window, search conditions, and search execution

► [“Analyzing and Searching Serial Bus Signals”](#) and [“Analyzing and Searching SPI Bus Signals \(Option\)”](#) in the Features Guide

SERIAL BUS SPI Menu

1. Press **SHIFT+SEARCH** (SERIAL BUS). The SERIAL BUS menu appears.
 - You can also tap **MENU** (☰) in the upper left of the screen and select the SERIAL BUS menu from ANALYSIS on the top menu that is displayed.
 - You can also press **ANALYSIS** and then the **To SERIAL BUS** soft key to display the SERIAL BUS menu.
 - The instrument can analyze and search the waveforms of up to four serial bus signals. To switch the setup menu, press the **Serial Bus** soft key and select a number from 1 to 4.
2. Press the **Type** soft key. Select **SPI** from the setup menu that is displayed. The following menu items appear.

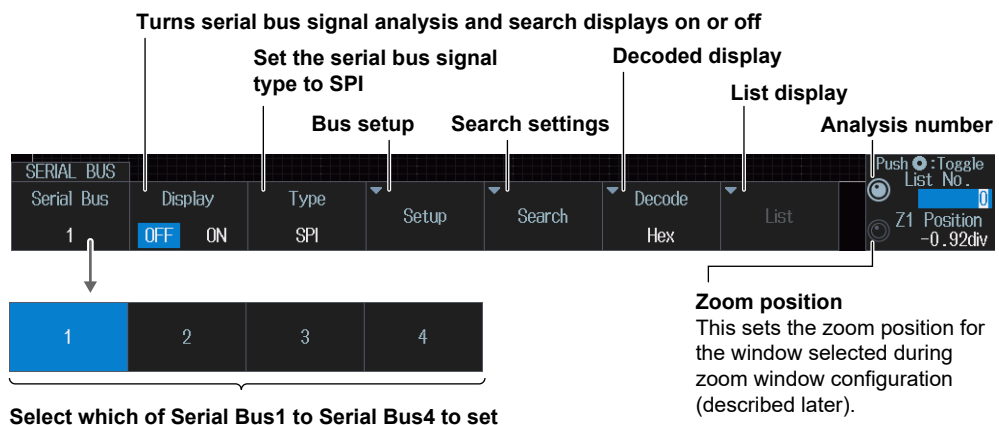

Bus Setup (Setup)

Note

Using the CH4 Terminal and Logic Signal Input Port

When you perform an analysis or execute a search, you cannot use the CH4 terminal and the logic signal input port as the source at the same time. Specify the source that you want to use in advance by pressing either CH4 or LOGIC.

Press the **Setup** soft key. The following menu items appear.

Auto Setup (Auto Setup)

When Wiring System Is 3 Wire

Execute automatic setup

Set the wiring system to 3 Wire

Clock source

Data1 source

Chip select source

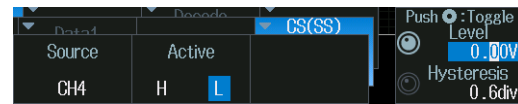

When the chip select source is LOGIC
(On models with the logic signal input port)

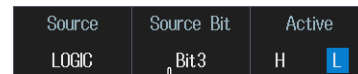

Source bit



When the Data 1 source is LOGIC
(On models with the logic signal input port)



Source bit

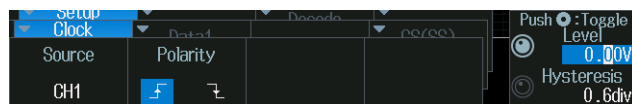

When the clock source is LOGIC
(On models with the logic signal input port)



Source bit

When Wiring System Is 4 Wire

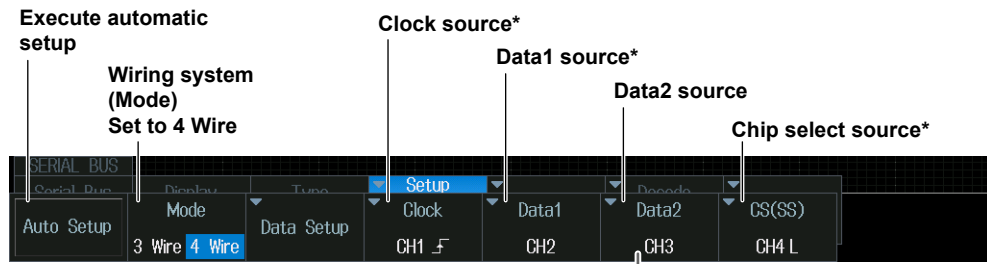

* This is the same as when Wiring System is set to 3 Wire.

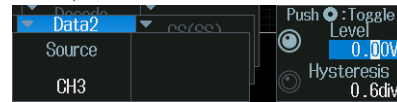

When the Data2 source is LOGIC
(On models with the logic signal input port)

Source	Source Bit
LOGIC	Bit2

Source bit

1. Set the wiring system and the clock, data, and chip select sources.

If you select LOGIC, set the source bit (Bit0 to Bit7).

You cannot use auto setup under the following circumstances.

- When the clock, Data1, Data2, or chip select source is set to Math1 to Math4.
- When state display is applied to any of the LOGIC bits set as the clock, Data1, Data2, or chip select source.
- When the chip select source is set to None (Ignore)

2. Press the **Auto Setup** soft key.

The instrument will perform auto setup. The instrument automatically configures the level and hysteresis and then triggers on the SPI signal's first data byte.

While the serial bus is being configured, Auto Setup changes to Abort. If you want to stop, press the **Abort** soft key.

The auto setup feature will not work properly on some input signals.

Manual Setup

After running auto setup, you can change the following settings and display decoded results.

- Wiring system
- Clock source
- Data 1 and 2 sources
- Chip select source
- Level used to detect clock source edges
- Level used to detect data source/chip select source states
- Hysteresis
- Polarity

Clock Source (Clock)

Press the **Clock** soft key. The following menu items appear.

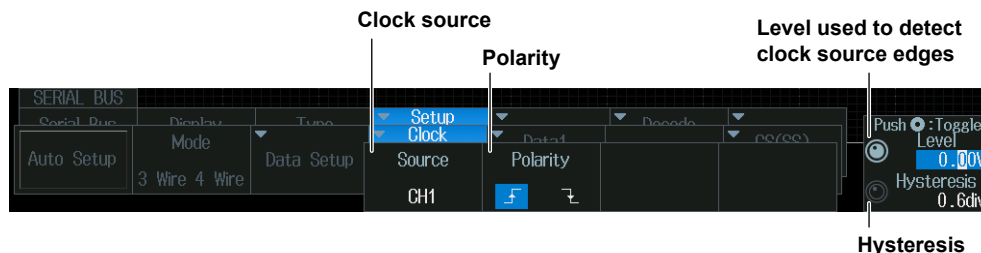

When the clock source is LOGIC
(On models with the logic signal input port)

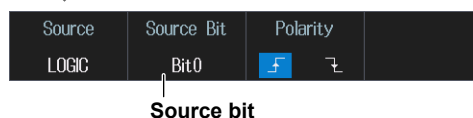

Data 1 and Data 2 Sources (Data1 and Data2)

Press the **Data1** or **Data2** soft key. The following menu items appear.

This section explains how to set the Data 1 source. The Data 2 source can be set in the same way. Set the Data2 source when the wiring system is 4 Wire.

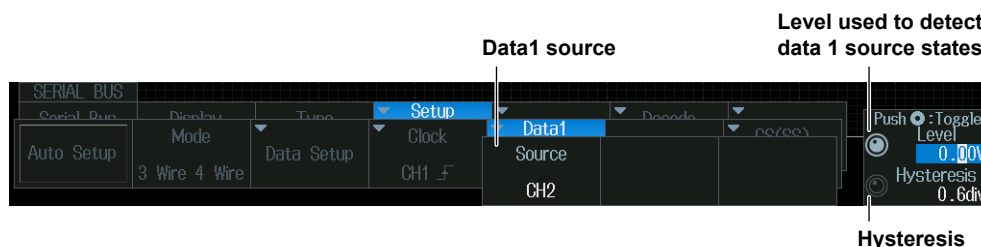

When the Data1 source is LOGIC
(On models with the logic signal input port)



12.10 Analyzing and Searching SPI Bus Signals (Option)

Chip Select Source (CS (SS))

Press the **CS(SS)** soft key. The following menu items appear.

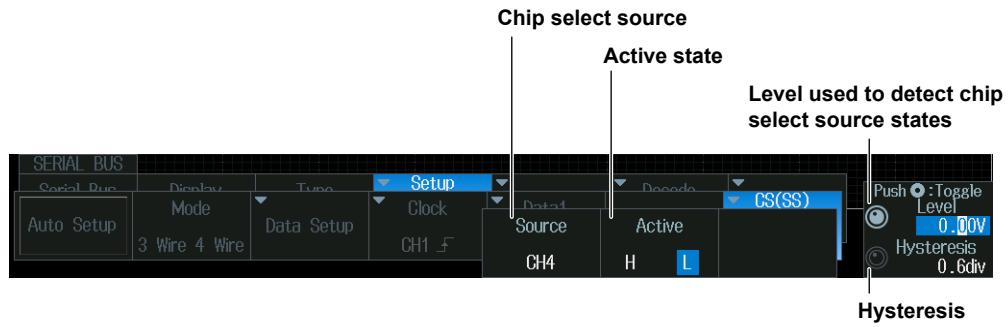

When the chip select source is **LOGIC**
(On models with the logic signal input port)

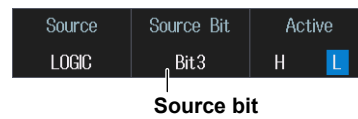

When the chip select source is set to **None**



Setting the Data Format (Data Setup)

Press the **Data Setup** soft key. The following menu items appear.

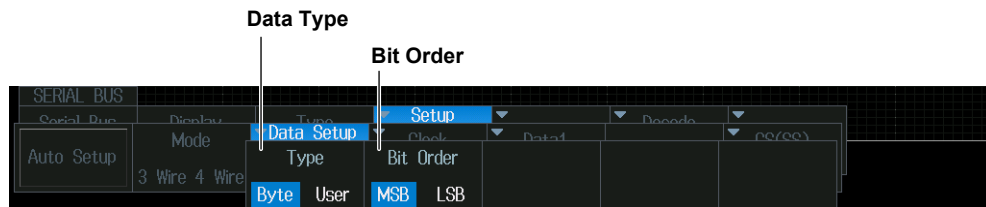

When the data type is **User**

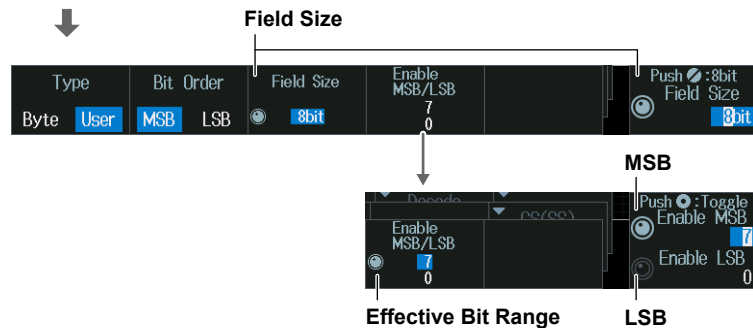

Decoded Display (Decode)

Press the **Decode** soft key. The following menu items appear.

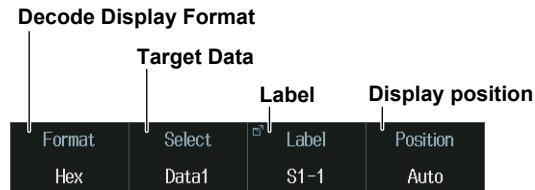

When the display position is set to Manual

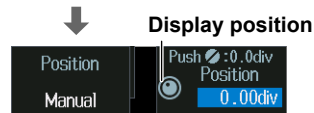

Decode Display Format (Format)

Select the decode display format.

Target Data (Select)

Select the data that you want to set the label and display position of.

Label (Label)

Select the decode displayed label.

Display Position (Position)

Set the display position of decoded results. The position is set to Auto when you execute auto setup on the analysis menu of each serial bus signal. The position changes from Auto to Manual when you drag the decode display.

List Display (List)

1. Press the **Display** soft key and turn on the analysis and search displays.
2. Press the **List** soft key.
 - The list of analysis results and the next menu appear.
 - When the wiring system is set to 3 Wire, the contents of Data 1 are displayed in a list. When the wiring system is set to 4 Wire, the contents of Data 1 and Data 2 are displayed in a list.
 - If several display settings of Serial Bus 1 to 4 are on, all the lists of analysis results of the serial buses whose display setting is on are displayed. For details, see section 12.12.

List of analysis results

No.	Time(ns)	Data1/2	Data
0	0.009000	Data1	D7 38
		Data2	D7 38
1	0.041000	Data1	1A D7 38 B4
		Data2	1A D7 38 B4
2	0.392992	Data1	9C
		Data2	9C
3	0.408992	Data1	BA 28
		Data2	BA 28
4	0.440992	Data1	47 BA 28 E0
		Data2	47 BA 28 E0

Analysis number

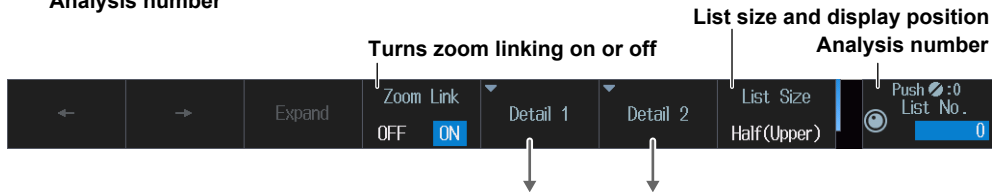

Turns zoom linking on or off

List size and display position
Analysis number

This is the list of analysis results that is displayed when you press the **Detail1** or **Detail2** soft key.
(All data for the specified analysis number are displayed. The following is an example for Detail 1.)

No.	Address	Hex	ASCII
0	00000000	D7 38	8

The data that corresponds to the selected data number is highlighted.

Data number



Data before the trigger position (on the left side of the waveform display) is assigned analysis numbers in descending order (-1, -2, and so on). Data after the trigger position (on the right side of the waveform display) is assigned analysis numbers in ascending order (0, 1, 2, and so on).

Search Setup (Search)

Press the **Search** soft key. The following menu items appear.

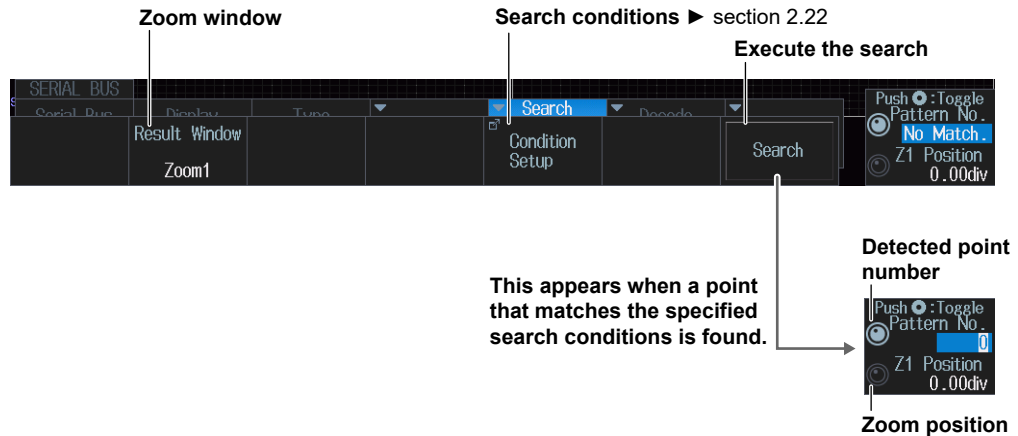

Zoom Windows (Result Window)

You can configure zoom windows Zoom1 and Zoom2 when they are displayed. Zoom1 is automatically displayed during the automatic setup of the analysis settings.

Search Conditions (Condition Setup)

You can set search conditions in the same way that you set trigger conditions. For details, see section 2.22.

Executing a Search (Search)

1. Set the search conditions.
2. Press the **Search** soft key.

The instrument searches for the search conditions. If the instrument finds points that match the search conditions (detected points), it shows numbers (0, 1, 2, etc.) from the left of the waveform display in the order that the points were detected.

Detected Point Number (Pattern No.)

You can set the detected point number and display the waveform for the detected point on the zoom window.

Zoom Position (Z1 Position/Z2 Position)

You can change the zoom position, which is the point on the waveform that is zoomed in on.

12.11 Analyzing and Searching User-Defined Serial Bus Signals

This section explains the following settings for analyzing or searching user-defined serial bus signals:

- Turning analysis and search displays on or off
- Serial bus signal types
- Bus setup
 - Data source, bit rate, decoding start point, clock source, enable source, and latch source
- Decoded display
- Zoom position
- Search settings
 - Zoom window, search conditions, and search execution

► [“Analyzing and Searching Serial Bus Signals”](#) and [“Analyzing and Searching User-Defined Serial Bus Signals \(User Define\)”](#) in the Features Guide

SERIAL BUS User Define Menu

1. Press **SHIFT+SEARCH** (SERIAL BUS). The SERIAL BUS menu appears.
 - You can also tap **MENU** (☰) in the upper left of the screen and select the SERIAL BUS menu from ANALYSIS on the top menu that is displayed.
 - You can also press **ANALYSIS** and then the **To SERIAL BUS** soft key to display the SERIAL BUS menu.
 - The instrument can analyze and search the waveforms of up to four serial bus signals. To switch the setup menu, press the **Serial Bus** soft key and select a number from 1 to 4.
2. Press the **Type** soft key. Select **User Define** from the setup menu that is displayed. The following menu items appear.

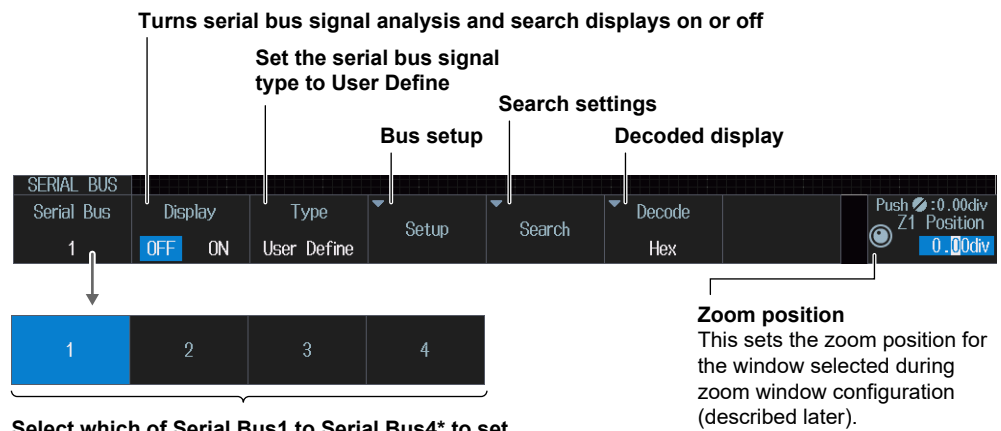

Select which of Serial Bus1 to Serial Bus4* to set

* Serial Bus 2 to Serial Bus 4 can be set only for 4-channel models.

Bus Setup (Setup)

Note

Using the CH4 Terminal and Logic Signal Input Port

If you perform an analysis or execute a search when using the logic signal input ports for input, you cannot specify CH4 as the source. Press CH4 in advance to enable input from the CH4 terminal.

Press the **Setup** soft key. The menu that appears varies depending on whether the clock is set on or off.

When the Clock Is Off

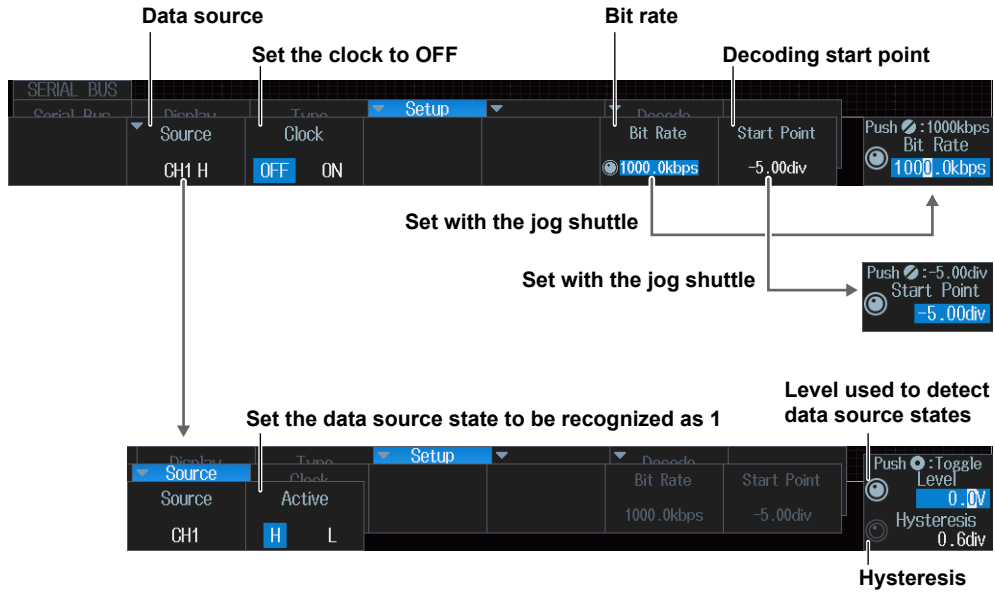

When the Clock Is On

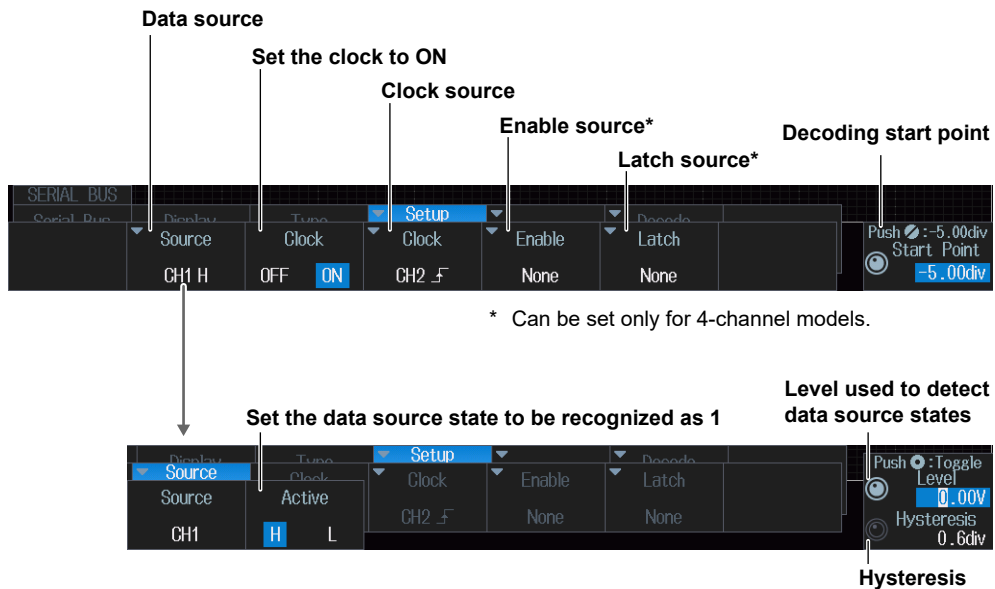

12.11 Analyzing and Searching User-Defined Serial Bus Signals

Clock Source (Clock)

Press the **Clock** soft key. The following menu items appear.

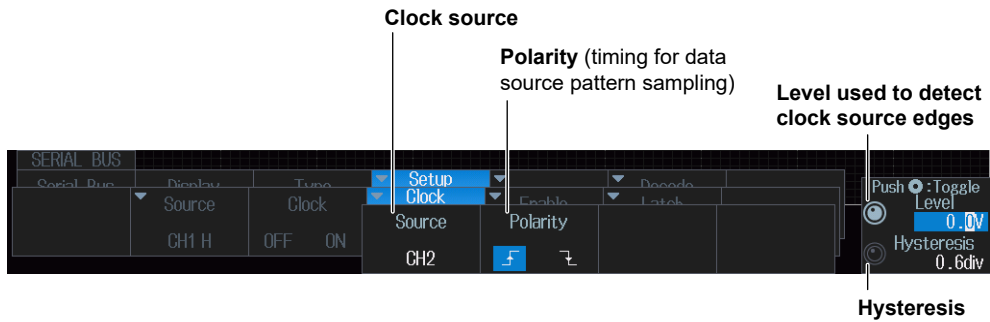

Specify which clock source edge causes the data source to be sampled.

Enable Source(Enable)

Press the **Enable** soft key. The following menu items appear.

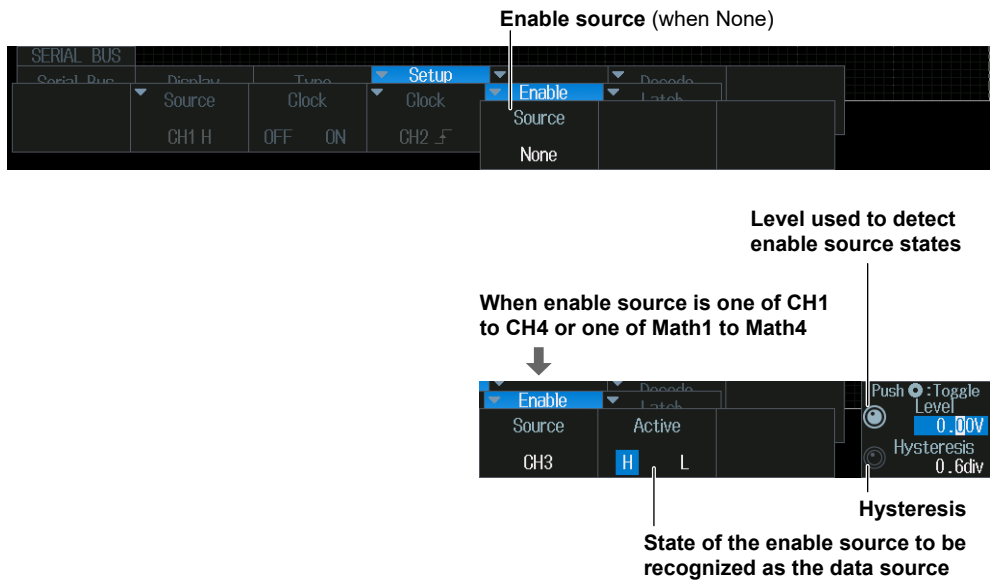

When the data source is sampled in sync with the clock source, use the enable source to control the period for which the instrument tests the data source.

Latch Source (Latch)

Press the **Latch** soft key. The following menu items appear.

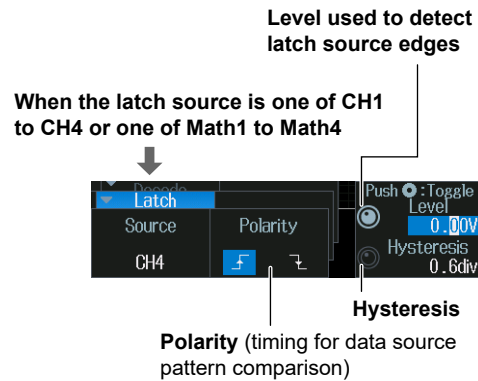
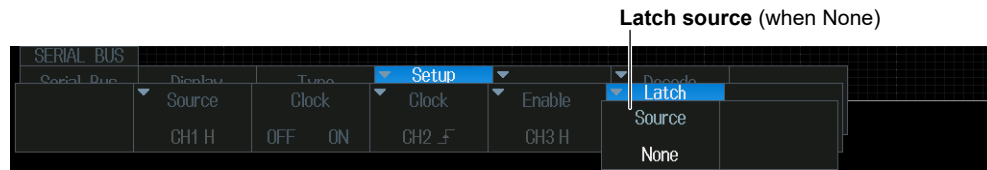

Specify the timing at which the data source pattern sampled in sync with the clock source is compared with the specified pattern.

Decoded Display (Decode)

Press the **Decode** soft key. The following menu items appear.

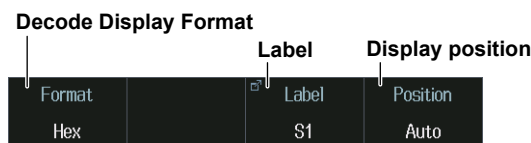

Decode Display Format (Format)

Select the decode display format.

Label (Label)

Select the decode displayed label.

Display Position (Position)

Set the display position of decoded results. The position is set to Auto when you execute auto setup on the analysis menu of each serial bus signal. The position changes from Auto to Manual when you drag the decode display.

Search Setup (Search)

Press the **Search** soft key. The following menu items appear.

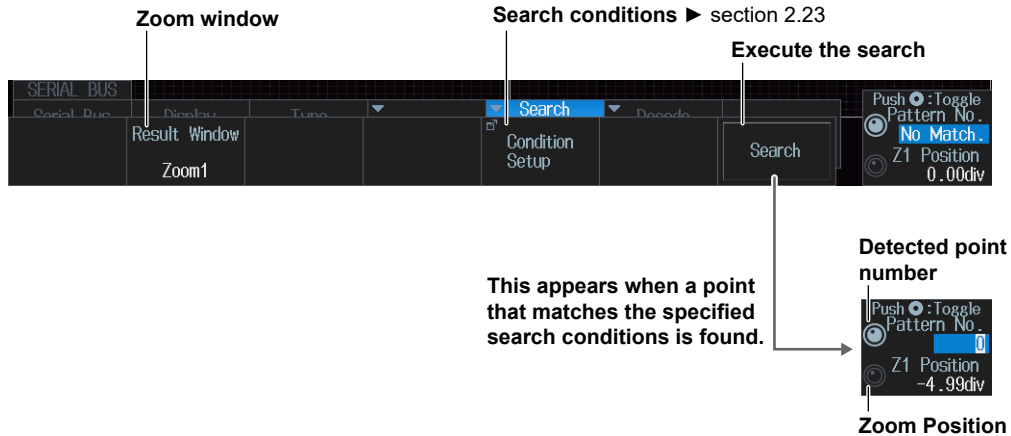

Zoom Windows (Result Window)

You can configure zoom windows Zoom1 and Zoom2 when they are displayed. Zoom1 is automatically displayed during the automatic setup of the analysis settings.

Search Conditions (Condition Setup)

You can set search conditions in the same way that you set trigger conditions. For details, see section 2.23.

Executing a Search (Search)

1. Set the search conditions.
2. Press the **Search** soft key.

The instrument searches for the search conditions. If the instrument finds points that match the search conditions (detected points), it shows numbers (0, 1, 2, etc.) from the left of the waveform display in the order that the points were detected.

Detected Point Number (Pattern No.)

You can set the detected point number and display the waveform for the detected point on the zoom window.

Zoom Position (Z1 Position/Z2 Position)

You can change the zoom position, which is the point on the waveform that is zoomed in on.

12.12 Displaying Multiple Lists

This section explains how to list the decoded results of multiple serial bus signals simultaneously.

► “Analyzing and Searching Serial Bus Signals” and “List Display” in the Features Guide

Serial Bus Signal Setup

1. Assign serial bus signals that you want to list simultaneously to **Serial Bus1** to **Serial Bus4**.
 ► sections 12.1 to 12.10

Listing the Analysis Results (List)

2. On the Serial Bus menu whose analysis and search displays (Display) are on, press the **List** soft key.
 The list of serial buses whose analysis and search displays (Display) are on and the following menu items appear.

Example: When List Size is set to Half(Upper), and the serial bus signal types are set as follows
Serial Bus1(S1): FlexRay, Serial Bus2(S2): CAN, Serial Bus3(S3): CAN, Serial Bus4(S4): UART

List of analysis results

S1: FlexRay			S2: CAN			S3: CAN			S4: UART		
No.	Time(ms)	S/D	No.	Time(ms)	Frame	No.	Time(ms)	Frame	No.	Time(ms)	Data
-3	-0.152032	S	-2	-0.103024	Erro	0	-0.145448	Erro	0	-0.00963	57 4
-2	-0.106832	S	-1	-0.041624	Erro	1	0.046552		1	0.16739	59 4
-1	-0.049632	S	0	-0.000624	Data	2	0.094552	Erro	2	0.35541	57 4
0	0.001568	D	1	0.073776		3	0.350560		3	0.53243	59 4
1	0.052768	D	2	0.112776	Erro				4	0.72045	57 4
2	0.103968	D	3	0.204176					5	0.89747	59 4
3	0.155168	S	4	0.255376							
4	0.206368	S	5	0.306576	Data						
5	0.257568	S	6	0.359776	Erro						
6	0.308768	S	7	0.408976	Remo						
7	0.359968	S	8	0.483576							
8	0.411168	D									

Cursor

The cursor of the list that is being used is highlighted.
 Only the frame appears for cursors of lists that are not being used.

- When zoom linking is on
 The zoom position in the zoom window (Result Window) moves in sync with the cursor on the list. If the signals of other lists are displayed in the same zoom window, the cursors of those lists also move in sync.

Moves to the left list

Moves to the right list

Expands the list you want to use or returns to the original screen

List size and display position

Analysis number

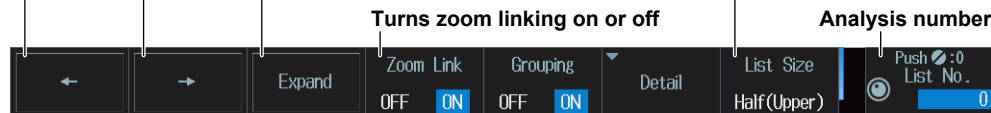

The setting menu changes to the serial bus menu for the selected list (UART example).

13.1 Displaying Waveform Histograms

This section explains the following settings for displaying a histogram of the frequency of data occurrence in a specified area:

- Turning the histogram on or off
- Source waveform
- Source axis
- The range over which the frequency is counted

▶ “Waveform Histogram Display” in the Features Guide

ANALYSIS Histogram Menu

1. Press **ANALYSIS**. The ANALYSIS menu appears.
You can also tap **MENU** (⊞) in the upper left of the screen and select the ANALYSIS menu from ANALYSIS on the top menu that is displayed.
2. Press the **Histogram** soft key. The following menu items appear.
 - Up to two histograms can be displayed. To switch the setup menu, press the **Histogram** soft key.

Select whether to set Histogram1 or Histogram2.*

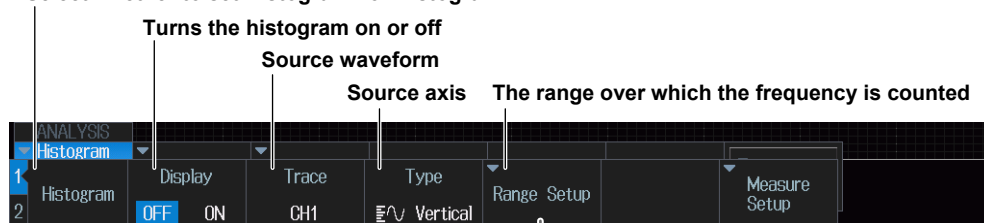

* Histogram2 can be set only for 4-channel models.

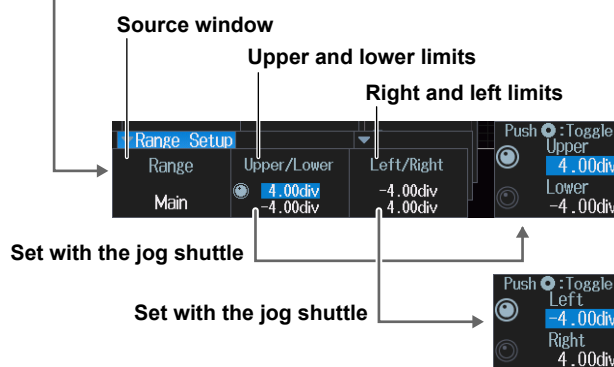

13.2 Measuring Histogram Parameters

This section explains the following settings for measuring histogram parameters:

- Measurement mode
- Measurement items
- Cursor measurement

► “Measurement (Measure Setup)” in the Features Guide

ANALYSIS Histogram Menu

Measure Setup Menu

1. Press **ANALYSIS**. The ANALYSIS menu appears.

You can also tap **MENU** (E) in the upper left of the screen and select the ANALYSIS menu from ANALYSIS on the top menu that is displayed.

2. Press the **Histogram** soft key and then the **Measure Setup** soft key. The following menu items appear.



When the measurement mode is Param

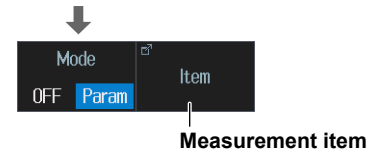

Measurement Items (Item)

Press the **Item** soft key. The following screen appears.

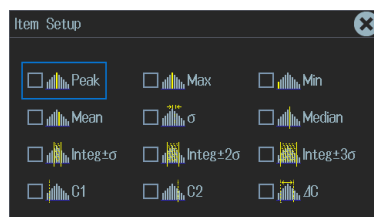

Select the measurement items that you want to use.

14.1 Power supply analysis type

This section explains how to set the power supply analysis type.

► [“Type \(Type\)” in the Features Guide](#)

ANALYSIS Power Analysis Menu

1. Press **ANALYSIS**. The ANALYSIS menu appears.
You can also tap **MENU** (☰) in the upper left of the screen and select the ANALYSIS menu from ANALYSIS on the top menu that is displayed.
2. Press the **Power Analysis** soft key. The following menu items appear.

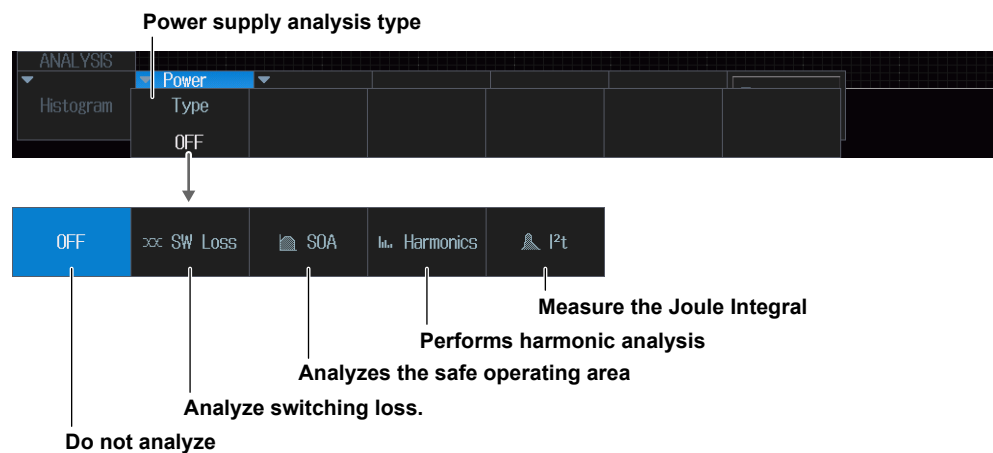

Note

Power supply analysis and power measurement of the power supply analysis feature cannot be executed simultaneously. If any of the power measurement items, Power Measurement1 or Power Measurement2, is set to ON, the power supply analysis is set to OFF. If power supply analysis is set to something other than OFF, all power measurements are set to OFF.

14.2 Analyzing Switching Loss

This section explains the following settings for analyzing switching loss:

- Probe
- Measurement setup
Loss type, level setup, reference levels for voltage channels, measurement items, turning measurement location indicator on or off, statistical processing, measurement source window, measurement range
- Turning power waveform display on and off
- Scaling
- Center point and sensitivity

► [“Switching Loss Analysis \(SW Loss\)” in the Features Guide](#)

ANALYSIS Power Analysis Menu

1. Press **ANALYSIS**. The ANALYSIS menu appears.
You can also tap **MENU** (M) in the upper left of the screen and select the ANALYSIS menu from ANALYSIS on the top menu that is displayed.
2. Press the **Power Analysis** soft key, then the **Type** soft key, and then the **SW Loss** soft key. The following menu items appear.

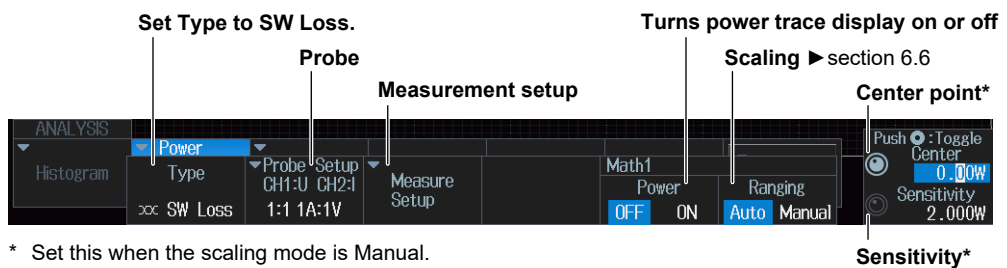

* Set this when the scaling mode is Manual.

Note

- If you set the power supply analysis type to SW Loss, automated measurement of waveform parameters is enabled. The measured values from the measurement items set on the MEASURE menu and the switching loss measurement items are displayed on the screen.
A maximum of 30 measurement items can be displayed. If measured switching loss values are not displayed, reduce the number of MEASURE menu measurement items.
► section 9.1
- If you set the power supply analysis type (Type) to SW Loss, the cycle mode (Cycle Mode) on the Item Setup screen (Page 9-2) of the MEASURE key menu is fixed to SW Loss.
- If you turn Power of Math1 on, the power waveform is displayed on the screen. If you then press MATH/REF, the following menu is displayed.

Operation is fixed to Power.



If you turn Power of Math1 off, the normal computation setup menu is displayed when you press MATH/REF.

Probe (Probe Setup)

Press the **Probe Setup** soft key. The following menu items appear.

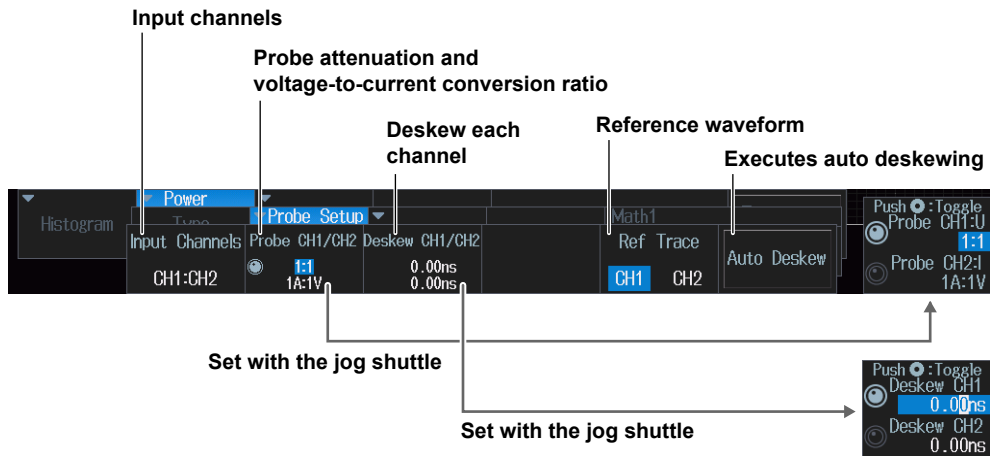

Measurement Setup (Measure Setup)

Press the **Measure Setup** soft key. The following menu items appear.

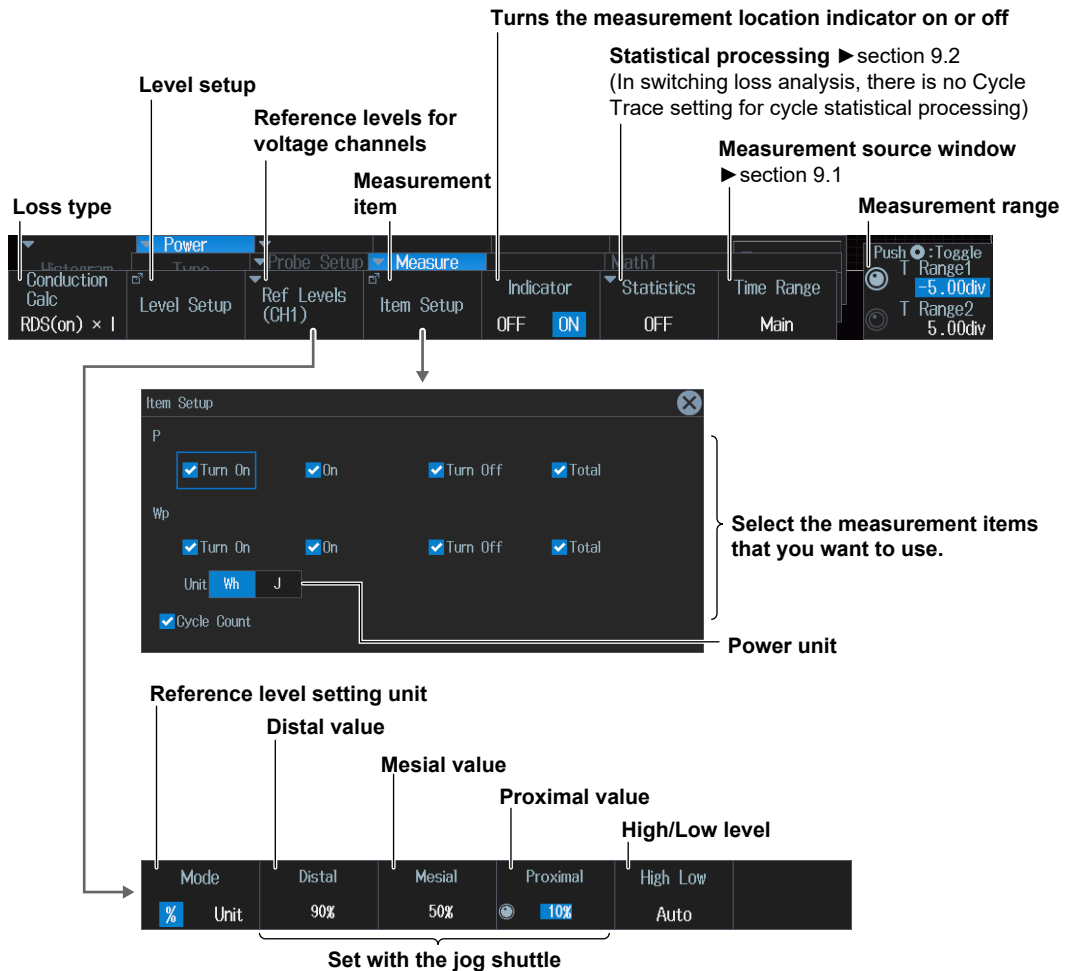

14.2 Analyzing Switching Loss

Level Setup (Level Setup)

Press the **Level Setup** soft key. The following screen appears.

When loss type is $U \times I$

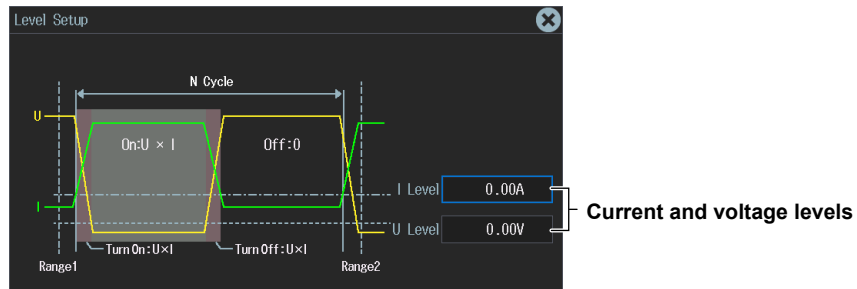

When loss type is $RDS(on) \times I^2$

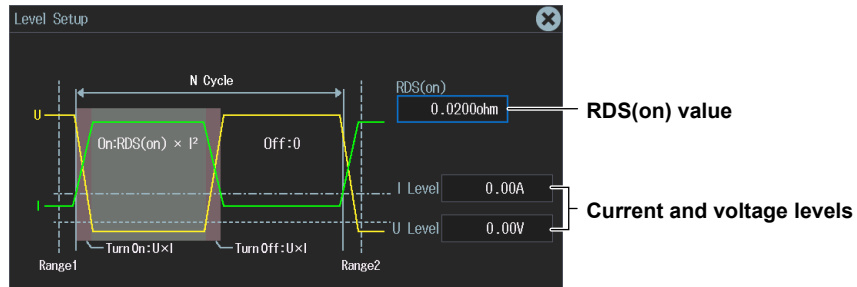

When loss type is $VCE(sat) \times I$

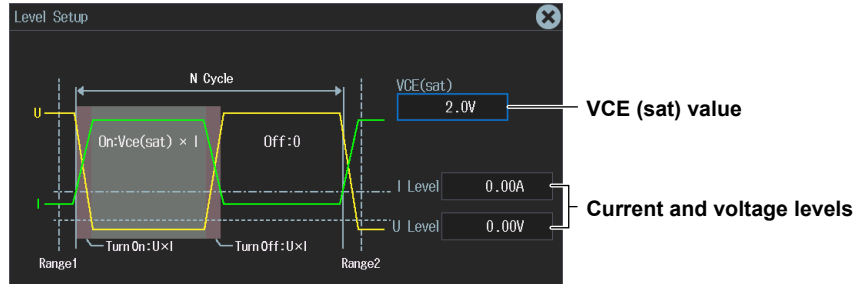

14.3 Performing Safe Operating Area Analysis

This section explains the following settings for performing safe operating area analysis:

- Probe
- Turning the VT waveform display on or off
- Cursor display
- Measurement range

► [“Safe Operating Area Analysis \(SOA\)” in the Features Guide](#)

ANALYSIS Power Analysis Menu

1. Press **ANALYSIS**. The ANALYSIS menu appears.
You can also tap **MENU** (☰) in the upper left of the screen and select the ANALYSIS menu from ANALYSIS on the top menu that is displayed.
2. Press the **Power Analysis** soft key, then the **Type** soft key, and then the **SOA** soft key. The following menu items appear.

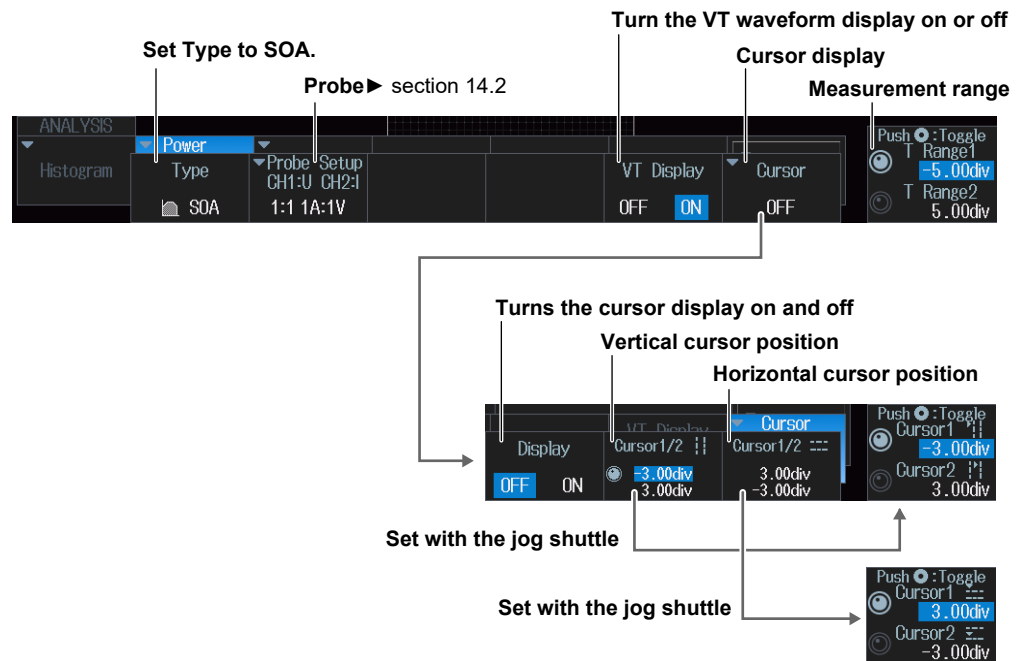

Note

If you set the power supply analysis type to SOA, XY waveforms are automatically displayed on the screen. If you press **SHIFT+DISPLAY** (X-Y) and then the **Display** soft key, both the XY window and the SOA disappear.

14.4 Performing Harmonic Analysis

This section explains the following settings for performing harmonic analysis:

- Probe
- Applicable class
- Harmonic grouping
- Display setup
- List storage and display
- Analysis start point
- EUT's power supply voltage

► [“Harmonic Analysis \(Harmonics\)” in the Features Guide](#)

ANALYSIS Power Analysis Menu

1. Press **ANALYSIS**. The ANALYSIS menu appears.

You can also tap **MENU** (☰) in the upper left of the screen and select the ANALYSIS menu from ANALYSIS on the top menu that is displayed.

2. Press the **Power Analysis** soft key, then the **Type** soft key, and then the **Harmonics** soft key. The following menu items appear.

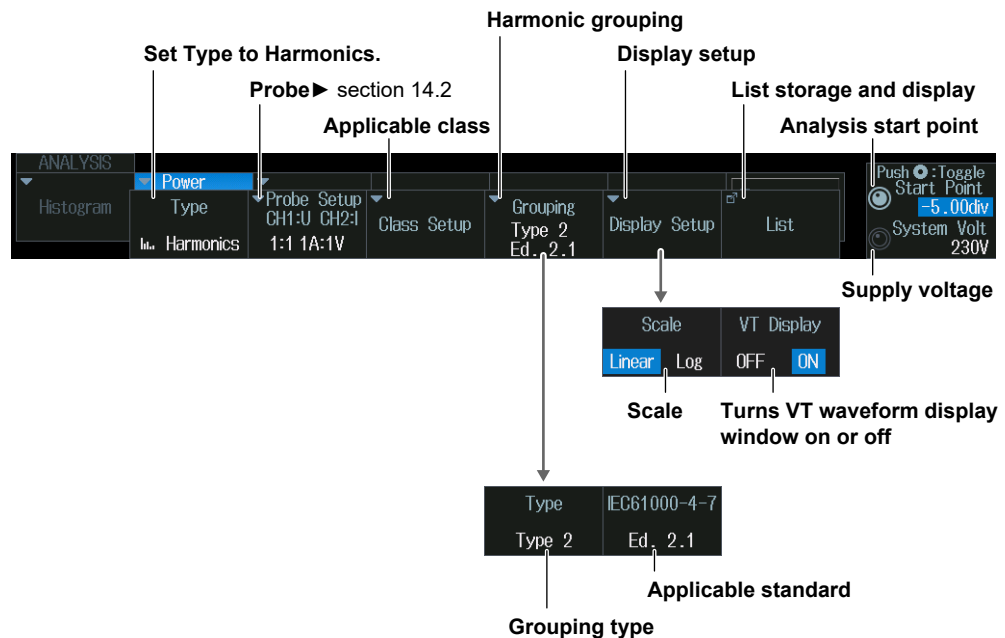

Applicable Class (Class Setup)

Press the **Class Setup** soft key. The following menu items appear.

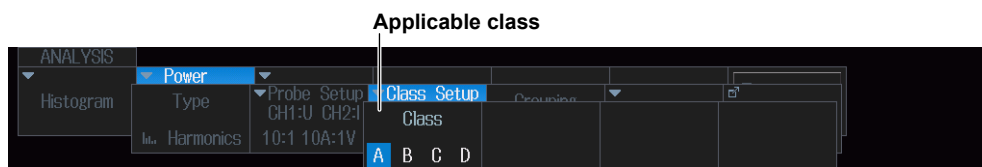

When the Applicable Class Is C

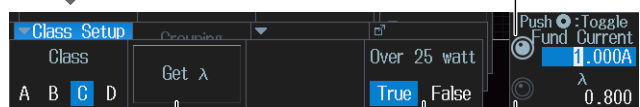

Obtains the EUT's power factor*

EUT's fundamental current

Active power exceeds 25 W (True) or not (False)

When the Applicable Class Is D

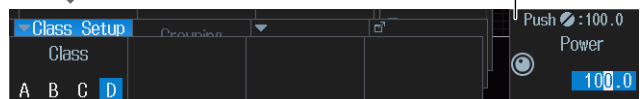

EUT's active power

* You can select this when the active power exceeds 25 W (Over 25 Watt is set to True).

Note

While λ (the power factor) is being obtained, Get λ changes to Abort. It may take time to obtain λ if the record length is long. To stop obtaining λ , press this Abort soft key.

List Storage and Display (List)

Press the **List** soft key. The following menu items appear.

• When the Applicable Class Is A, B, or D

Order	Measure(A)	Limit(A)	Info
1	0.897		
2	0.000	1.080	
3	0.299	2.300	
4	0.000	0.430	
5	0.179	1.140	
6	0.000	0.300	
7	0.128	0.770	
8	0.000	0.230	
9	0.099	0.400	
10	0.000	0.184	
11	0.082	0.330	
12	0.000	0.153	

THD 46.9%
RMS 0.931A

• When the Applicable Class Is C

Order	Measure(A)	Limit(A)	Measure(%)	Limit(%)	Info
1	0.569	0.569(Max)			
2	0.000	0.011	0.069	2.000	
3	0.064	0.137	11.225	30.000	
4	0.001		0.117		
5	0.023	0.057	4.005	10.000	
6	0.001		0.123		
7	0.011	0.040	1.988	7.000	
8	0.001		0.164		
9	0.006	0.028	1.139	5.000	
10	0.001		0.170		
11	0.005	0.017	0.860	3.000	
12	0.001		0.102		

THD 12.2%
RMS 0.573A

Save List List Size
Half(Upper)

14.5 Measuring the Joule Integral

This section explains the following settings for measuring the Joule integral:

- Probe
 - Measurement setup
 - Turns Joule integral waveform display on or off
 - auto scaling
 - Center point and sensitivity
- Turning Joule integral on or off, measurement source window, measurement range

► “Measuring Inrush Current by Measuring the Joule Integral (I^2t)” in the Features Guide

ANALYSIS Power Analysis Menu

1. Press **ANALYSIS**. The ANALYSIS menu appears.
You can also tap **MENU** (☰) in the upper left of the screen and select the ANALYSIS menu from ANALYSIS on the top menu that is displayed.
2. Press the **Power Analysis** soft key, then the **Type** soft key, and then the I^2t . The following menu items appear.

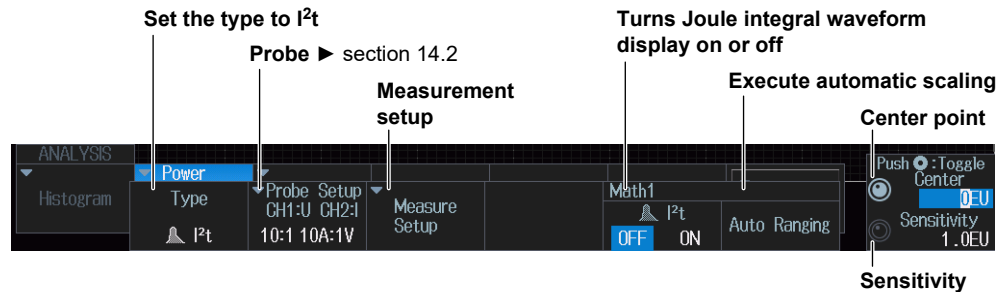

Measurement Setup (Measure Setup)

Press the **Measure Setup** soft key. The following menu items appear.

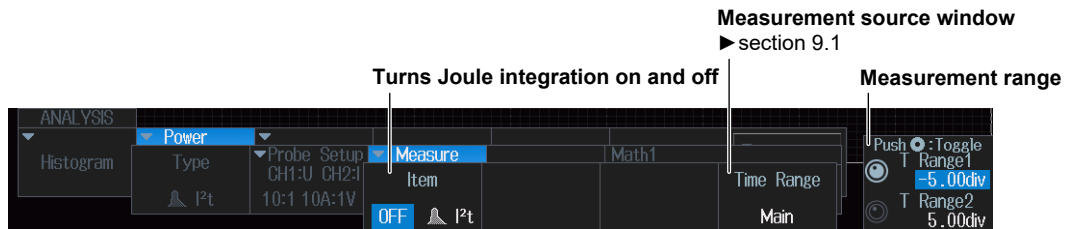

Note

- If you set the power supply analysis type to I^2t , automated measurement of waveform parameters is enabled. The measured values from the measurement items set on the MEASURE menu and the Joule integral measurement items are displayed on the screen.
A maximum of 30 measurement items can be displayed. If measured Joule integral values are not displayed, reduce the number of MEASURE menu measurement items.
► section 9.1
- If you turn I^2t of Math1 on, the Joule integral waveform is displayed on the screen. If you then press MATH/REF key, the following menu is displayed.



If you turn I^2t of Math1 off, the normal computation setup menu is displayed when you press MATH/REF.

14.6 Measuring Power

This section explains the following settings for measuring power:

- Turning power measurement on or off
- Probe
- Measurement content

Measurement items, reference levels for auto measurement, measurement location indicator, cycle mode, calculation that uses automated measurement values, statistical processing, measurement source window, measurement range

► [“Power Measurement \(Power Measurement\)” in the Features Guide](#)

ANALYSIS Power Measurement Menu

1. Press **ANALYSIS**. The ANALYSIS menu appears.

You can also tap **MENU** (☰) in the upper left of the screen and select the ANALYSIS menu from ANALYSIS on the top menu that is displayed.

2. Press the **Power Measurement** soft key. The following menu items appear.

- Up to two power measurements can be displayed. To switch the setup menu, press the **Power Measurement** soft key.

Select which analysis number to set (Power Measurement1 or Power Measurement2)

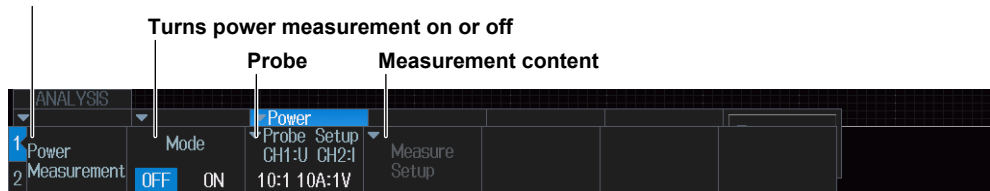

The voltage and current input channels are fixed as follows:

Power Measurement	Voltage Input Channel	Current Input Channel
Power Measurement1	CH1	CH2
Power Measurement2	CH3	CH4

Probe (Probe Setup)

Press the **Probe Setup** soft key. The following menu items appear.

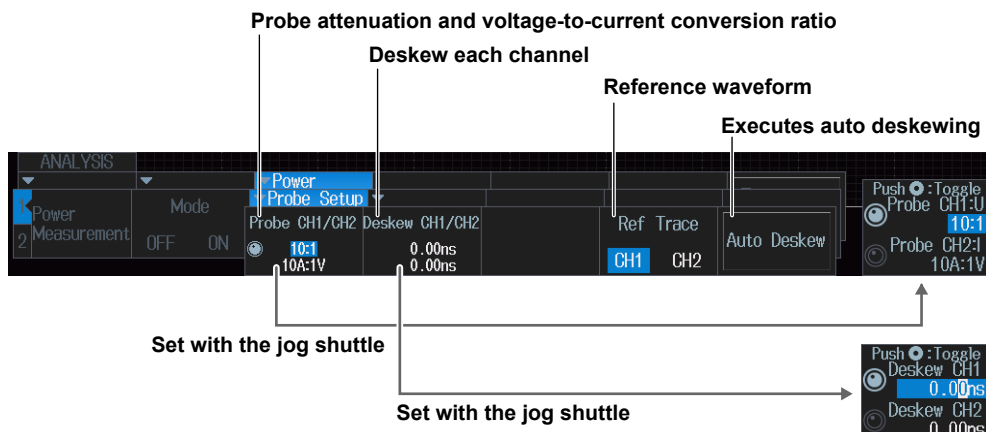

Measurement Setup (Measure Setup)

1. Press the **Mode** soft key and set Power Measurement ON.
2. Press the **Measure Setup** soft key. The following menu items appear.

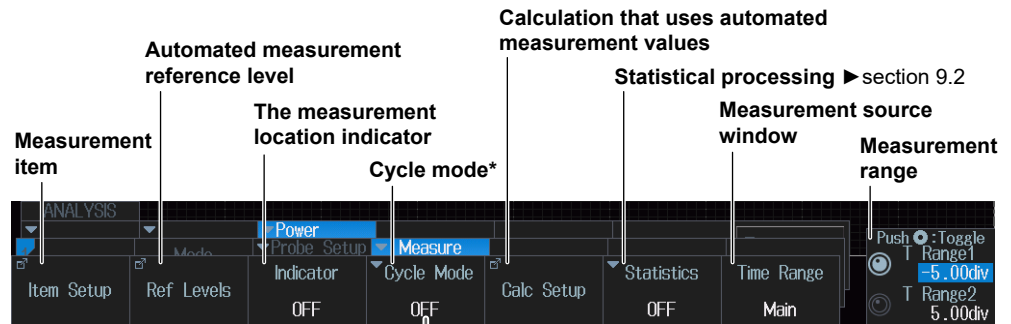

* This is fixed to OFF when the statistical processing type is set to Cycle.

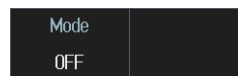

When cycle mode is N Cycle

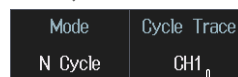

Source waveform used to determine the cycle

Measurement Items (Item Setup)

Press the **Item Setup** soft key. The following menu items appear.

Clear the check boxes of all the measurement items.

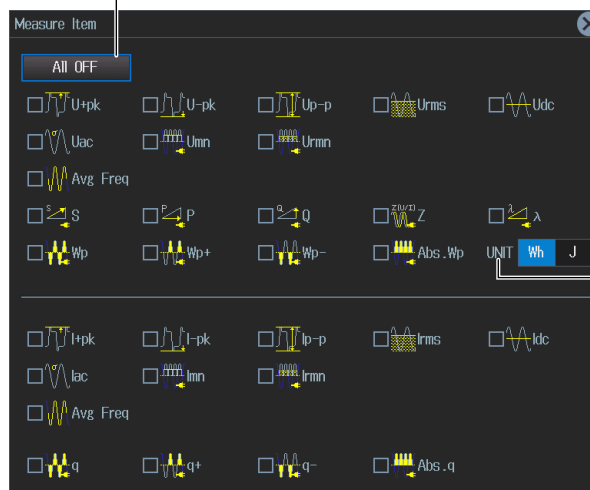

Measurement items of voltage input channels CH1, CH3
Select the measurement items that you want to use.

Unit

Measurement items of current input channels CH2, CH4
Select the measurement items that you want to use.

14.6 Measuring Power

Reference Levels for Auto Measurements (Ref Levels)

Press the **Ref Levels** soft key. Depending on the power measurement that is selected (Power Measurement1 or Power Measurement2), the following screen appears.

In the case of Power Measurement 1 (CH1/CH2)

Labels in the screenshot:

- Reference level setting unit (points to the Mode dropdown)
- Distal value (points to the Distal percentage field)
- Mesial value (points to the Mesial percentage field)
- Proximal value (points to the Proximal percentage field)
- High/Low level (points to the High/Low dropdown)

In the case of Power Measurement 2 (CH3/CH4)

Calculations That Use Automated Measurement Values (Calc Setup)

Press the **Calc Setup** soft key. The following menu items appear.

Select the expressions to use

Labels in the screenshot:

- Name (up to 8 characters) (points to the Name column)
- Expression (points to the Expression column)
- Unit (up to 4 characters) (points to the Unit column)

	Name	Expression	Unit
<input checked="" type="checkbox"/>	Calc1	Max(C1)	
<input type="checkbox"/>	Calc2	Min(C2)	
<input type="checkbox"/>	Calc3	High(M1)	
<input type="checkbox"/>	Calc4	Low(M2)	

Labels in the screenshot:

- Define an expression by combining computation source waveforms and operators (points to the Max(C1) field)
- Add the results of automated measurement of waveform parameters to the expression. (points to the Measure button)

Measure	PI	e	fs	1/fs
C1 M1 SIN COS TAN 7 8 9 /				
C2 M2 ASIN ACOS ATAN 4 5 6 *				
C3 M3 EXP LN LOG 1 2 3 -				
C4 M4 ABS P2 SQRT 0 . Exp +				
A1 A2 , () Enter				

- Inserts a) (points to the ')' key)
- Moves the cursor (points to the left and right arrow keys)
- Deletes the character at the cursor position (points to the 'Delete' key)
- Deletes the previous character (points to the 'BS' key)
- Deletes all the characters you have entered (points to the 'Clear' key)
- Enters the expression (points to the 'Enter' key)

Measurement Location Indicator (Indicator)

1. Press the **Indicator** soft key.
You can set Indicator to OFF (the measurement location indicator is not displayed) or display a setup menu with the items whose check boxes you have selected in "Setting the Measurement Items (Item Setup)."
2. Use the **jog shuttle** or the **SET** key to select the item whose measurement location you want to indicate.
3. Press **SET** to confirm.
The measurement location of the item you specify is indicated by a cursor.

Note

- If you turn Power Measurement on, automated measurement of waveform parameters is enabled. The measured values from the measurement items set on the MEASURE menu and the values of the Power Measurement measurement items are displayed on the screen.
A maximum of 30 measurement items can be displayed. If Power Measurement measurement values are not displayed, reduce the number of MEASURE menu measurement items.
▶ section 9.1
 - If you turn Power Measurement ON, the cycle mode (Cycle Mode) on the Item Setup screen (Page 9-2) of the MEASURE key menu changes in sync with the setting of the cycle mode (Cycle Mode) of Power Measurement, and it cannot be set on the MEASURE key menu.
 - If you change the statistical processing type (Statistics), the statistical processing type (Statistics) of the MEASURE key menu also changes in sync.
-

15.1 Displaying History Waveforms

This section explains the following settings for displaying history waveforms, which are waveforms that were previously saved to acquisition memory:

- Display mode
- Turning averaging on or off
- Highlighting of the selected record number
- Display range (start and end record numbers)
- Showing a list of timestamps
- Replay
- Gradation mode

▶ “Displaying and Searching History Waveforms” in the Features Guide

HISTORY Menu

Press **HISTORY**. The following menu items appear.

You can also tap **MENU** (MENU) in the upper left of the screen and select the HISTORY menu from ACQ/DISP on the top menu that is displayed.

Display mode

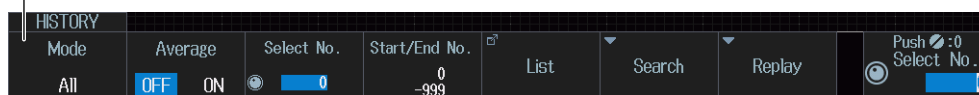

Display Mode (Mode)

One: Only the waveform corresponding to the selected record number¹ is displayed.

All: All waveforms other than the highlighted one are displayed in an intermediate color.¹ All history waveforms from the specified start (Start Record) to stop (End Record) number are overlaid.²

Accumulate: The frequency of data occurrence is represented by intensity (Intensity) or by color (Color). Overlays all selected waveforms.²

1 Specify the highlighted waveform with Select No.

2 Specify with Start and End No.

When the Display Mode Is Set to One or All

Set the display mode to One or All.

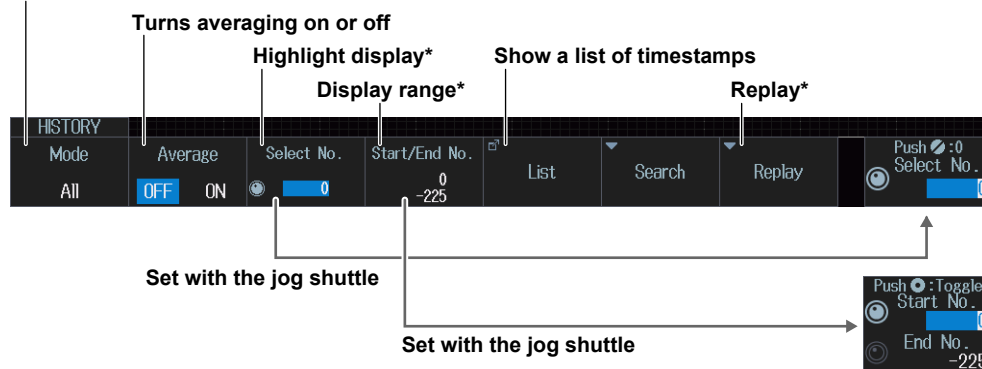

* The Select No., Start/End No, and Replay menu items appear when averaging is off.

15.1 Displaying History Waveforms

When the Display Mode Is Set to Accumulate

Set the display mode to Accumulate



List of Timestamps (List)

Press the **List** soft key. The following screen appears.

Record number

Trigger time

The difference between the triggered time of the current data and the data before it

History List

No.	Triggered Time					Delta				
	s	ms	us	ns	ps	s	ms	us	ns	ps
0	10:36:38	173	718	450		0	000	055	800	
-1	10:36:38	173	662	650		0	000	055	800	
-2	10:36:38	173	606	850		0	000	055	800	
-3	10:36:38	173	551	050		0	000	055	800	
-4	10:36:38	173	495	250		0	000	055	800	
-5	10:36:38	173	439	450		0	000	055	800	
-6	10:36:38	173	383	650		0	000	055	800	
-7	10:36:38	173	327	850		0	000	055	800	
-8	10:36:38	173	272	050		0	000	055	800	
-9	10:36:38	173	216	250		0	000	055	800	
-10	10:36:38	173	160	450		0	000	055	800	
-11	10:36:38	173	104	650		0	000	055	800	
-12	10:36:38	173	048	850		0	000	055	800	
-13	10:36:38	172	993	050		0	000	055	800	
-14	10:36:38	172	937	250		0	000	055	800	
-15	10:36:38	172	881	450		0	000	055	800	
-16	10:36:38	172	825	650		0	000	055	800	
-17	10:36:38	172	769	850		0	000	055	800	
-18	10:36:38	172	714	050		0	000	055	800	
-19	10:36:38	172	658	250		0	000	055	800	
-20	10:36:38	172	602	450		0	000	055	800	
-21	10:36:38	172	546	650		0	000	055	800	
-22	10:36:38	172	490	850		0	000	055	800	
-23	10:36:38	172	435	050		0	000	055	800	
-24	10:36:38	172	379	250		0	000	055	800	
-25	10:36:38	172	323	450		0	000	055	800	
-26	10:36:38	172	267	650		0	000	055	800	

List of timestamps

Delta Min Delta Max Oldest Latest

Jump to the latest record number

Jump to the oldest record number

Jump to the record number whose data contains the triggers with the most time between them

Jump to the record number whose data contains the triggers with the least time between them

Note**Notes about Configuring the History Feature**

- When the acquisition mode is set to Average and the sampling mode is set to Repetitive, you cannot use the history feature.
- When the display is in roll-mode, you cannot use the history feature.
- If you stop waveform acquisition, the instrument only displays waveforms that have been acquired completely.

Notes about Recalling Data Using the History Feature

- Waveform acquisition stops when you display the History menu. You cannot display history waveforms while waveform acquisition is in progress.
- You can start waveform acquisition when the History menu is displayed. However, you cannot change the history feature settings while waveform acquisition is in progress.
- The settings are restricted so that the following relationship is retained: Last record (End) \leq Select No. \leq First record (Start).
- When you load waveform data from the specified storage device, history waveforms up to that point are cleared. The loaded waveform data is placed in record number zero. If you load a file containing multiple waveforms, the latest waveform is placed in zero, and earlier waveforms are placed in order to record numbers -1, -2, and so on.
- Computation and automated measurement of waveform parameters are performed on the waveform of the record number specified by Select No. You can analyze old data as long as you do not overwrite the acquisition memory contents by restarting waveform acquisition. If Average is set to ON, analysis is performed on the averaged waveform.
- History waveforms are cleared when you turn the power off.

Replay (Replay)

Press the **Replay** soft key. The following menu items appear.

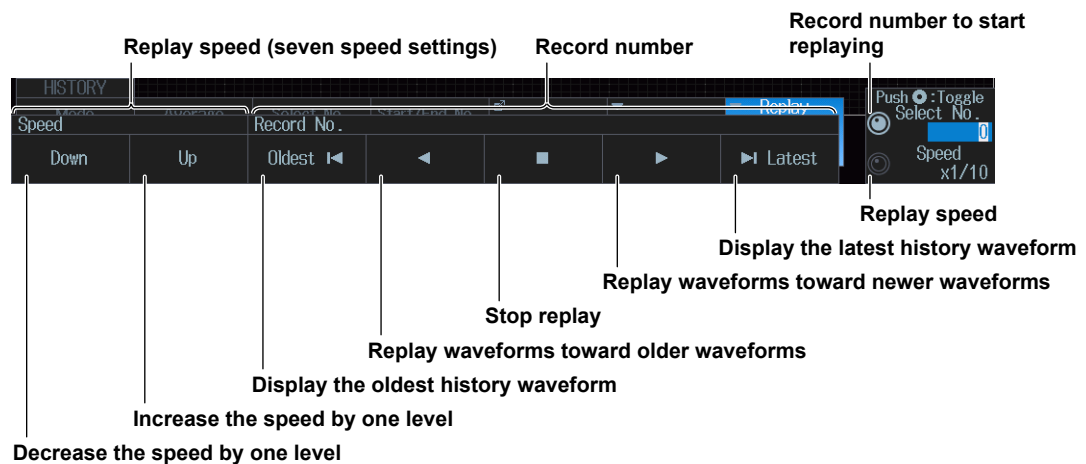
**Note**

If you change the vertical sensitivity, vertical position, time axis setting, trigger position, or other relevant settings and then display the preview, you cannot search for or replay history waveforms.

15.2 Searching History Waveforms

This section explains the following settings for searching history waveforms:

- Search condition
- Waveform to search
- Search source window
- Search range (rectangular zone)
- Search conditions 1 to 4
- Search range mode
- Executing searches
- Finishing searches

▶ “Searching History Waveforms (Search)” in the Features Guide

HISTORY Menu

1. Press **HISTORY**. The HISTORY menu appears.
You can also tap **MENU** (E) in the upper left of the screen and select the HISTORY menu from ACQ/DISP on the top menu that is displayed.
2. Press the **Mode** soft key, and then the **One** soft key or the **All** soft key. The following menu items appear.

Set the display mode to One or All.

Search history waveforms

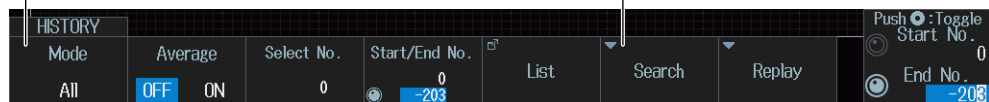

Searching History Waveforms (Search)

Press the **Search** soft key. The menu that appears varies depending on the search condition settings.

When the Search Condition Is Set to Simple

Set the search condition to Simple

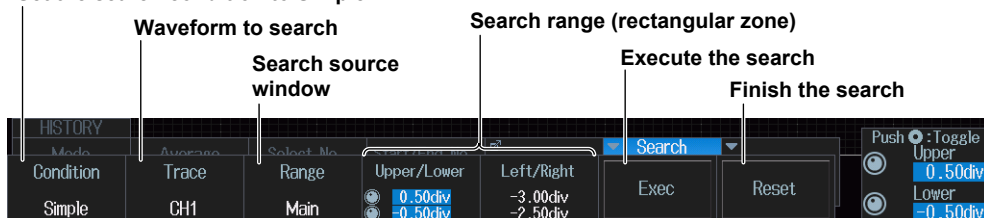

- **Search range (rectangular zone)**

You can set the search range in the same manner that you set the reference range type for GO/NO-GO determination (RectZone). See section 2.28, and read all instances of “determination” as “search.”

When the Search Condition Is Set to AND or OR

Set the search condition (AND, OR)

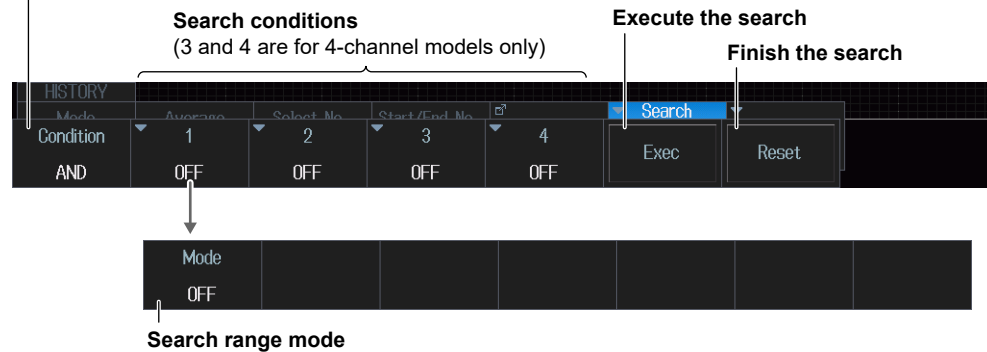

When the search range mode is RectZone

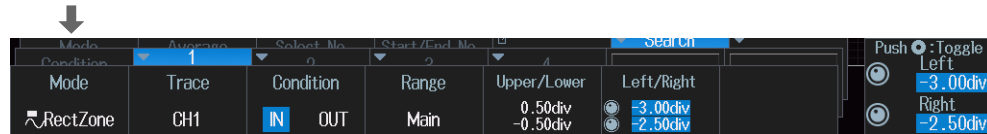

When the search range mode is WaveZone

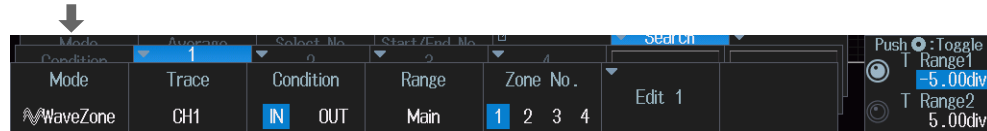

When the search range mode is PolygonZone

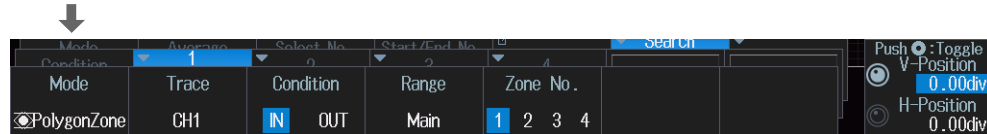

When the search range mode is Parameter

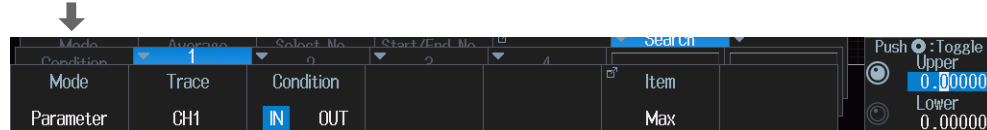

- **Search Range Mode (Mode)**

You can set the search range mode in the same manner that you set the reference range type for GO/NO-GO determination. See section 2.28, and read all instances of “determination” as “search.” When the search condition and the waveform to search are set as follows, there are some search ranges that cannot be set.

- When you set the waveform to search to XY1 to XY2, you cannot set the search range mode to WaveZone.
- When you set the waveform to search to LOGIC*, FFT1, or FFT2, you can only set the search range mode to Parameter.

* CH4 or LOGIC, whichever the corresponding key is illuminated, can be selected. Specify the channel that you want to search through in advance by pressing either the CH4 key or the LOGIC key.

16.1 Loading Roll Paper Into the Built-In Printer (Option)

This section explains how to load roll paper into the optional built-in printer.

Printer Roll Paper

Use a YOKOGAWA roll paper. Do not use any other paper. When using the printer for the first time, use the roll paper supplied with the instrument. When you need extra roll paper, please contact your nearest YOKOGAWA dealer.

Part Number: B9988AE
Specification: Heat-sensitive paper, 10 m
Minimum Quantity: 10 rolls

Handling Roll Paper

The roll paper is made of heat-sensitive paper that changes color thermochemically. Please read the following information carefully.

Storage Precautions

The heat-sensitive paper changes color gradually at temperatures of approximately 70°C or higher. The paper can be affected by heat, humidity, or chemicals, whether something has been recorded on it or not. As such, please follow the guidelines listed below.

- Store the paper in a cool, dry, and dark place.
- Use the paper as quickly as possible after you break its protective seal.
- If you attach a plastic film that contains plasticizing material such as vinyl chloride film or cellophane tape to the paper for a long time, the recorded sections will fade due to the effect of the plasticizing material. Use a holder made of polypropylene to store the roll paper.
- When starching the record paper, do not use starches containing organic solvents such as alcohol or ether. Doing so may cause a malfunction.
- We recommend that you make copies of the recordings if you intend to store them for a long period of time. Because of the nature of heat-sensitive paper, the recorded sections may fade.

Handling Precautions

- Only use genuine YOKOGAWA roll paper.
- If you touch the roll paper with sweaty hands, there is a chance that you will leave fingerprints on the paper or smudge the recorded sections.
- If you rub the surface of the roll paper against something hard, there is a chance that the paper will change color due to frictional heat.
- If the roll paper comes into contact with chemicals, oil, and the like, there is a chance that the paper will change color or that the recorded sections will disappear.

Loading the Roll Paper



CAUTION

- Do not touch the print head. If you do, you may burn yourself.
- Do not touch the roll paper cutter section at the end of the printer cover. Doing so may cause injury.

French



ATTENTION

- Ne pas toucher la tête d'impression. Vous pourriez vous brûler.
- Ne pas toucher la section du coupe-papier à l'extrémité du cache de l'imprimante. Vous pourriez vous blesser.

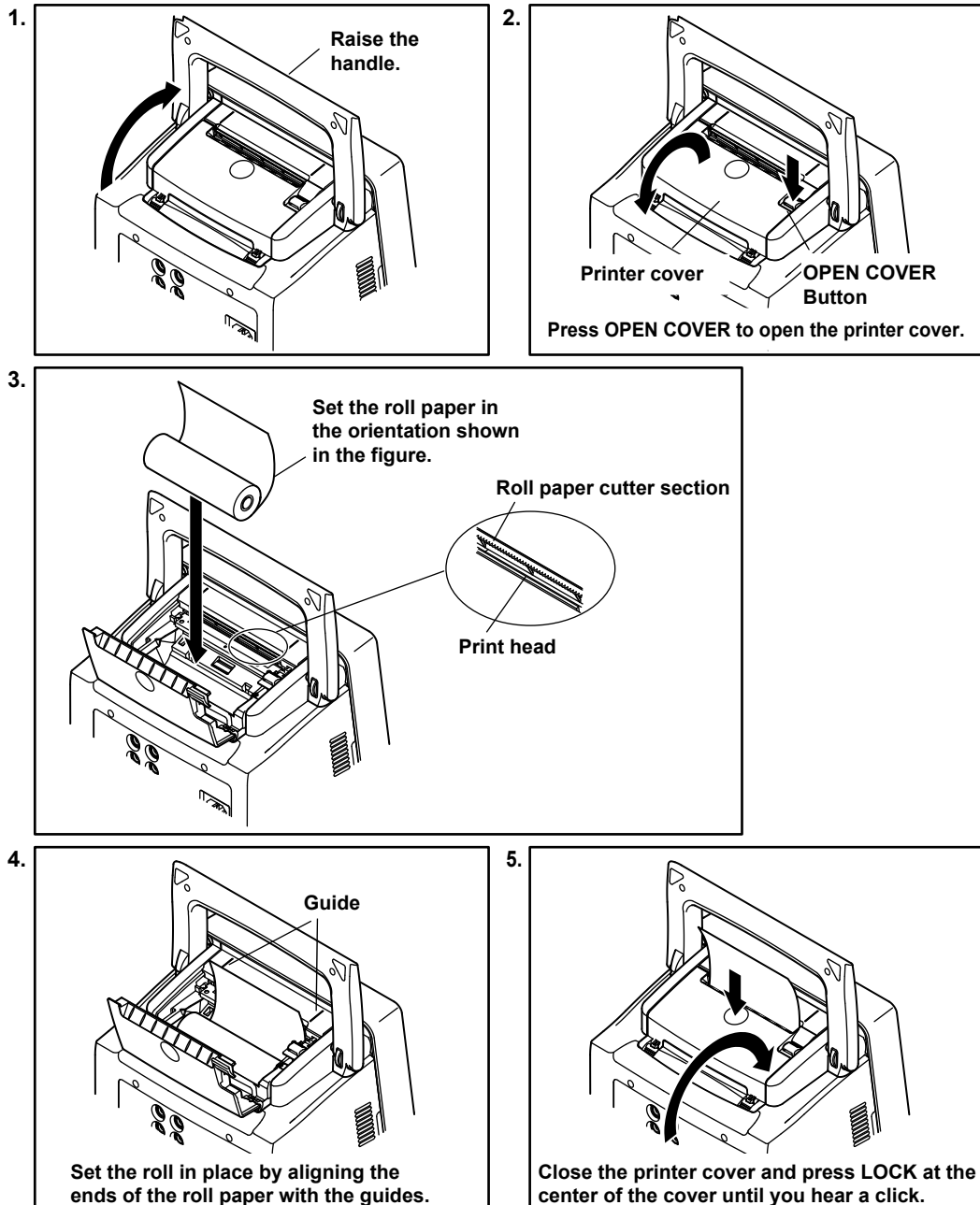

16.2 Printing on the Built-in Printer (Option)

This section explains the following settings for printing on the built-in printer (option):

- Output destination
- Print mode
- Additional information

► [“Printing on the Built-in Printer \(BuiltIn\) \(Option\)” in the Features Guide](#)

PRINT BuiltIn Menu

1. Press **SHIFT+PRINT** (MENU). The PRINT menu appears.
You can also tap **MENU** (☰) in the upper left of the screen and select the PRINT menu (PRINTMENU) from FILE/PRINT on the top menu that is displayed.
2. Press the **Print To** soft key and then the **BuiltIn** soft key. The following menu items appear.

Set the print destination to BuiltIn.

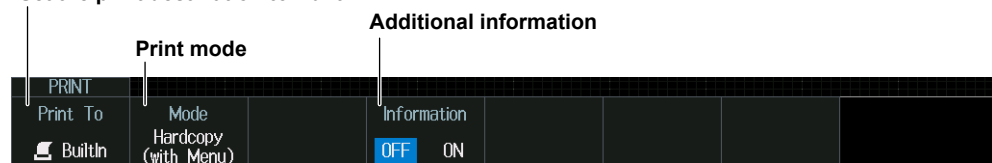

Print Mode (Mode)

Hardcopy (with Menu): The entire instrument screen is printed.

Hardcopy (without Menu): The waveform area of the instrument screen is printed. The menu is not printed.

Printing

Press **PRINT**. The image is output to the built-in printer according to the settings.

16.3 Printing on a USB Printer

This section explains the following settings for printing on a USB printer:

- Output destination
- Print mode
- Printer type
- Color
- Waveform gradation

► “Printing on a USB Printer (USB)” in the Features Guide

PRINT USB Menu

1. Press **SHIFT+PRINT** (MENU). The PRINT menu appears.
You can also tap **MENU** (MENU) in the upper left of the screen and select the PRINT menu (PRINTMENU) from FILE/PRINT on the top menu that is displayed.
2. Press the **Print To** soft key and then the **USB** soft key. The following menu items appear.

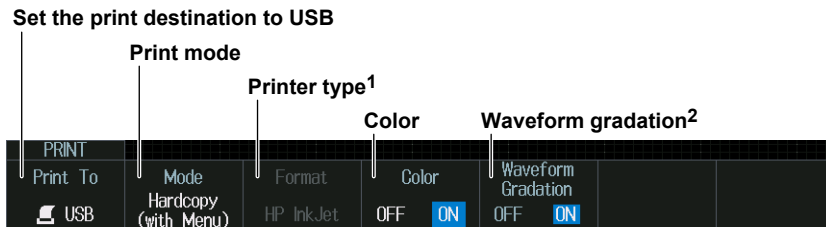

- 1 The printer type is fixed to HP InkJet.
- 2 This appears when Color is set to ON.

Print Mode (Mode)

Hardcopy (with Menu): The entire instrument screen is printed.

Hardcopy (without Menu): The waveform area of the instrument screen is printed. The menu is not printed.

Waveform Gradation (Waveform Gradation)

Gradation can be applied to the waveform color when Color is set to ON.

ON: Gradation is applied to the waveform color.

OFF: Solid color is used for the waveform.

Printing

Press **PRINT**. The image is output to the USB printer according to the settings.

16.4 Printing on a Network Printer

This section explains the following settings for printing on a network printer:

- Output destination
- Print mode
- Printer type
- Color
- Waveform gradation

► [“Printing on a Network Printer \(Network\)” in the Features Guide](#)

PRINT Network Menu

1. Press **SHIFT+PRINT** (MENU). The PRINT menu appears.
You can also tap **MENU** (MENU) in the upper left of the screen and select the PRINT menu (PRINTMENU) from FILE/PRINT on the top menu that is displayed.
2. Press the **Print To** soft key and then the **Network** soft key. The following menu items appear.

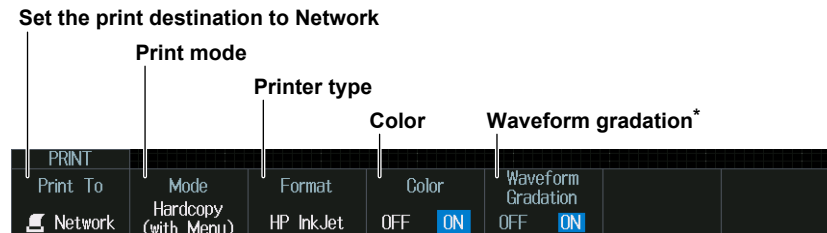

* This appears when Color is set to ON.

Print Mode (Mode)

Hardcopy (with Menu): The entire instrument screen is printed.

Hardcopy (without Menu): The waveform area of the instrument screen is printed. The menu is not printed.

Waveform Gradation (Waveform Gradation)

Gradation can be applied to the waveform color when Color is set to ON.

ON: Gradation is applied to the waveform color.

OFF: Solid color is used for the waveform.

Printing

Press **PRINT**. The image is output to the network printer according to the settings.

Note

You must configure the network printer in advance by following the instructions in section 18.6.

16.5 Saving Screen Captures to Files

This section explains the following settings for saving screen captures to files:

- Output destination
- Save mode
- Data format
- Color data
- Background transparency (transparent or opaque)
- setting information, including
- Waveform gradation
- Save destination
- File name

► “Saving Screen Captures to Files (File)” in the Features Guide

PRINT File menu

1. Press **SHIFT+PRINT** (MENU). The PRINT menu appears.
You can also tap **MENU** (☰) in the upper left of the screen and select the PRINT menu (PRINTMENU) from FILE/PRINT on the top menu that is displayed.
2. Press the **Print To** soft key and then the **File** soft key. The following menu items appear.

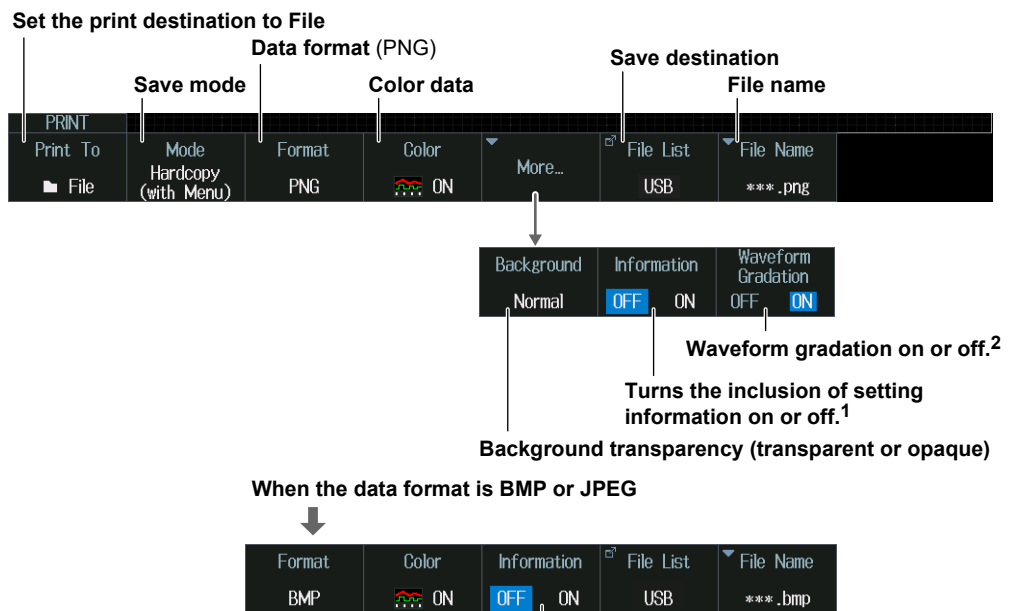

1 You can set this when the save mode is Hardcopy (with Menu) or Hardcopy (without Menu).

2 Gradation can be applied to the waveform color when Color data is set to ON (Rev.).

Save mode (Mode)

Hardcopy (with Menu): The entire instrument's screen is saved.

Hardcopy (without Menu): The waveform area of the instrument's screen is saved. The menu is not saved.

Wide: As in Hardcopy (without Menu) mode, the entire instrument's screen is saved, but the time axis is magnified 2 times.

Including Setting Information (Information)

When save mode is set to Hardcopy (with Menu) or Hardcopy (without Menu), channels, triggers, waveform acquisition, and other setting information can be included in waveform screen captures.

OFF: Setting information is not included.

ON: Setting information is included.

Waveform Gradation (Waveform Gradation)

Gradation can be applied to the waveform color when Color data is set to ON (Rev.).

ON: Gradation is applied to the waveform color.

OFF: Solid color is used for the waveform.

Save Destination (File List)

Specify the drive or folder to save files to in the same way as for the file feature. For details, see section 17.2.

File name (File Name)

This is the same as the file feature (except the comment feature). You can save files with automatically generated names using sequence numbers or dates, or save the files with specific file names. For details, see section 17.2.

Saving

Press **PRINT** to save the screen capture file to the specified folder.

Screen Capture Examples

a. When the save conditions are set as follows

Save mode (Mode): Hardcopy (with Menu) Data Format (Format): PNG
 Color data (Color): ON(Rev.) Background (Background): Normal
 Setting information (Information): ON

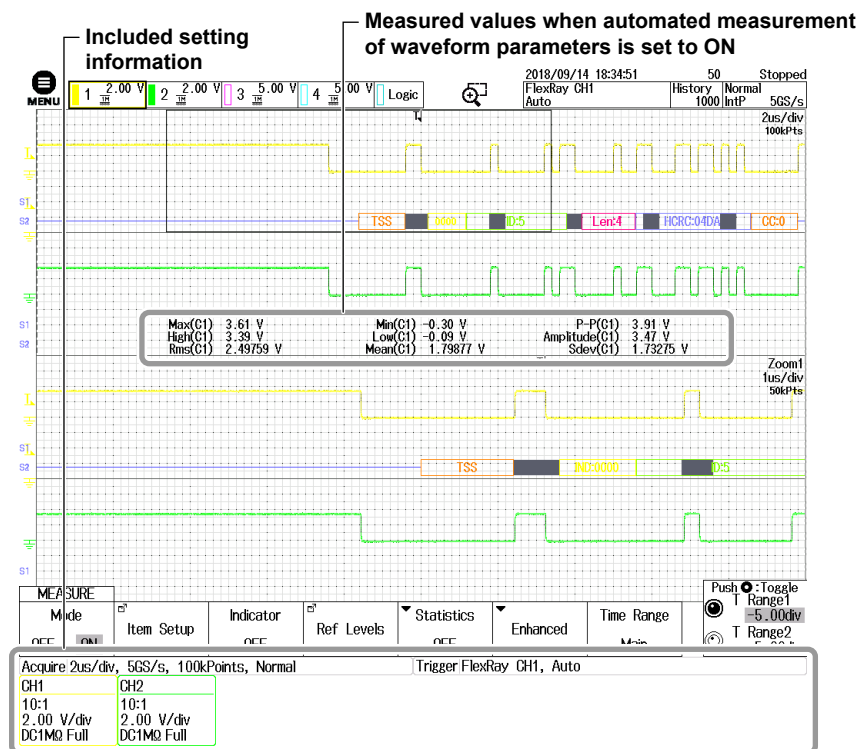

16.5 Saving Screen Captures to Files

- b. When ESC is pressed from the condition of a to hide the menu and the measured values of waveform parameters are displayed at the bottom of the screen

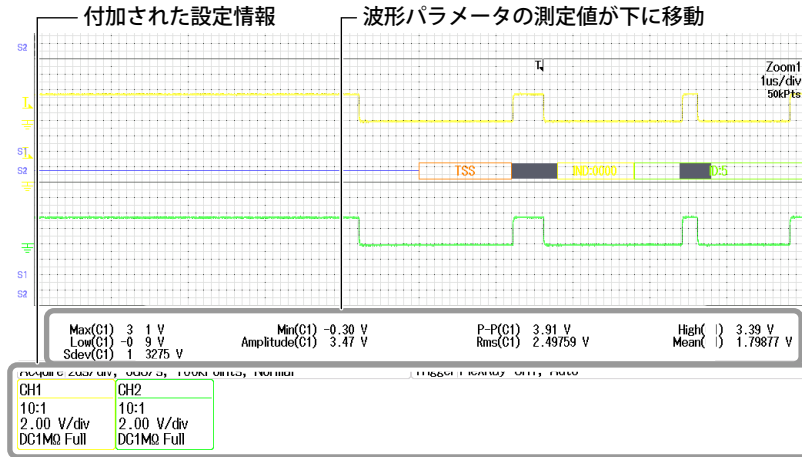

16.6 Printing and Saving Screen Capture Data to Multiple Output Destinations at the Same Time

This section explains the following settings for printing and saving screen capture data and waveform data to multiple output destinations at the same time:

- Output destination
- Saving screen captures to files
- Printing screen captures on the built-in printer (option)
- Printing screen captures on the USB printer
- Printing screen captures on a network printer
- Saving waveform data

▶ “[Printing and Saving Screen Captures to Multiple Destinations \(Multi\)](#)” in the [Features Guide](#)

PRINT Multi menu

1. Press **SHIFT+PRINT (MENU)**. The PRINT menu appears.
You can also tap **MENU (MENU)** in the upper left of the screen and select the PRINT menu (PRINTMENU) from FILE/PRINT on the top menu that is displayed.
2. Press the **Print To** soft key and then the **Multi** soft key. The following menu items appear.

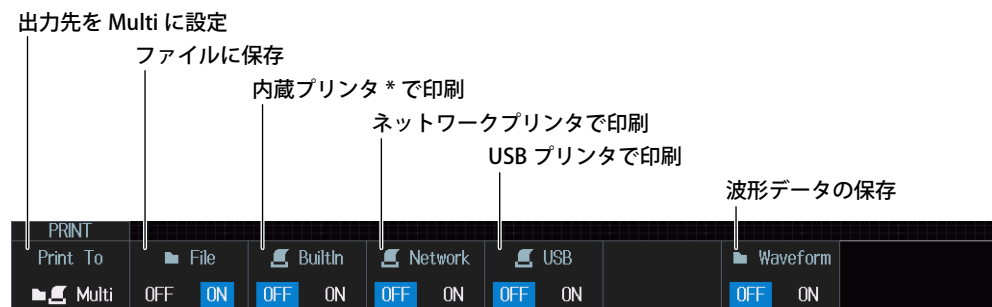

* オプション (Option)

The instrument outputs screen capture data and waveform data according to the PRINT menu or FILE menu settings. For details on those settings, see the following sections.

- Saving screen captures to files
▶ section 16.5
- Printing screen captures on the built-in printer (option)
▶ section 16.2
- Printing screen captures on the USB printer
▶ section 16.3
- Printing screen captures on a network printer
▶ section 16.4
- Saving waveform data
▶ section 17.2

Note

You cannot execute action-on-trigger or GO/NO-GO determination if Print To is set to Multi when Print is set to ON on the ACTION menu. ▶ sections 2.27 to 2.28

Printing and Saving

Press **PRINT**. The screen capture or waveform data is output to the specified output destination.

17.1 Connecting USB Storage Device to the USB Ports

CAUTION

Do not remove the USB storage device or turn off the power when the media (internal storage or USB storage device) access icon is blinking in the center of the screen or when the USB storage device access indicator is blinking. Doing so may damage the storage device or corrupt its data.

Access Icon



French

ATTENTION

Ne retirez pas le support de stockage USB et ne mettez pas l'alimentation hors tension lorsque l'icône d'accès au support (mémoire interne ou stockage USB) clignote au centre de l'écran ou que le voyant d'accès au support de stockage USB clignote. Vous risqueriez d'endommager le support de stockage ou les données qu'il contient.

Icône d'accès



You can connect/disconnect a USB cable at any time regardless of whether the instrument is on or off (hot-plugging is supported). Connect the type A connector of the USB cable to the instrument, and connect the type B connector to the USB storage device. If you connect a USB storage device when the power switch is on, the device becomes available for use after the instrument identifies it.

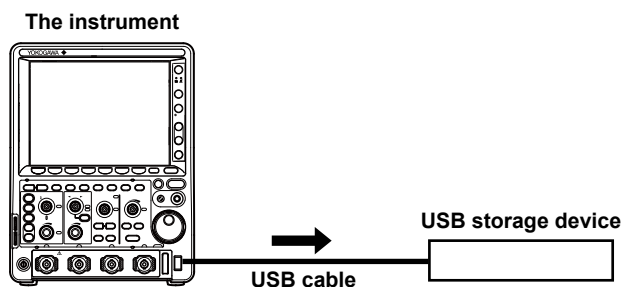

Note

- Only connect a compatible USB keyboard, mouse, printer, or storage device to the USB port for peripherals.
- Do not connect and disconnect multiple USB devices repetitively. Provide at least a 10-second interval between removal and connection.
- Do not connect or remove USB cables from the time when the instrument is turned on until key operation becomes available (approximately 20 to 30 seconds).
- You can use USB storage device that are compatible with USB Mass Storage Class Ver. 1.1.
- The supported formats of USB storage are exFAT, FAT32, and FAT16.
- The instrument can handle up to two storage devices. If the connected medium is partitioned, the instrument treats each partition as a separate storage device. As such, the instrument can handle up to two partitions.

Confirming What Connected USB Storage Device Can Be Used

1. Press **FILE** and then the **Utility** soft key. A file list appears.
For details on the file list, see section 17.8.
2. Select  (display one level up), and then press **SET**.
 - Since the next higher level is displayed, repeats until the media is displayed in the file list.
 - For more information on file operations, see section 17.8.

17.2 Saving Waveform Data

This section explains the following settings for saving waveform data:

- Save destination
- File name
- Data format
- Waveform to save
- History range
- Window to be saved
- Data compression
- Saving waveform data

► [“Saving Waveform Data \(Waveform\)” in the Features Guide](#)

File Waveform (Save) Menu

1. Press **FILE**. The FILE menu appears.
You can also tap **MENU** (MENU) in the upper left of the screen and select the FILE menu from FILE/PRINT on the top menu that is displayed.
2. Press the **Waveform (Save)** soft key. The following menu items appear.

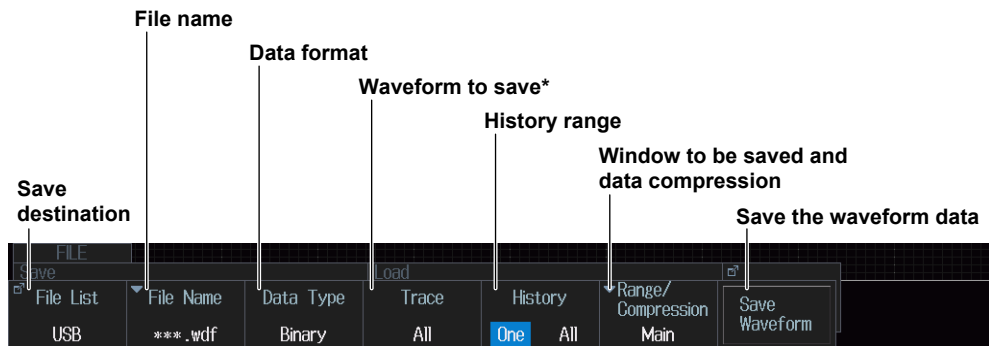

* The instrument saves data from the CH4 or LOGIC waveform, depending on which channel's key is illuminated.
Specify the channel that you want to save in advance by pressing either the CH4 key or the LOGIC key.

Save Destination (File List)

Press the **File List** soft key. The following screen appears.

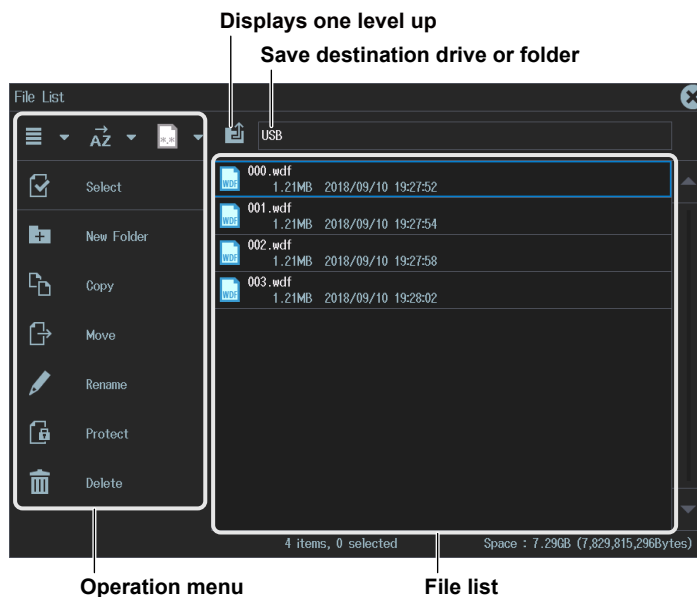

For more information on file operations, see section 17.8.

File name (File Name)

Press the **File Name** soft key. The following menu items appear.



Auto Naming (Auto Naming)

- OFF:** The auto naming feature is disabled. The name that you specify using the File Name setting is used. If a file with the same name exists in the save destination folder, an overwrite confirmation dialog box is displayed.
- Numbering:** The instrument automatically adds a three-digit number from 000 to 999 or a four-digit number from 1000 to 4999 after the common name specified using the File Name setting and saves the file.
- Date:** As shown in the figure below, the instrument uses an 8-character file name that is produced based on the date and time using base-36 numbers (0 to 9 and A to Z). The file name specified using the File Name setting is not used.

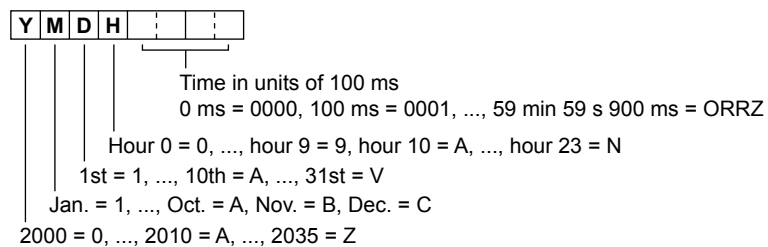

- Date2:** The file name is the date and time (down to ms) when the file is saved. The file name specified using the File Name setting is not used.

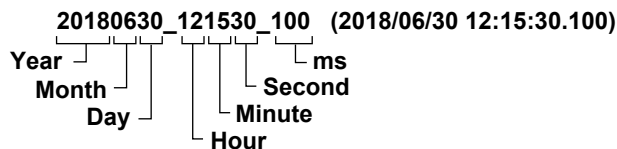

File name (File Name)

You can set the common file name that is used when the auto naming feature is turned off or when the auto naming feature is set to Numbering.

Comment (Comment)

You can add a comment that consists of up to 128 characters when you save a file. You do not have to enter a comment. All characters, including spaces, can be used in comments.

Data Type (Data Type)

Binary: Data is saved in binary format (the extension is .wdf).

ASCII: Data is saved in ASCII format (the extension is .csv).

ASCII with TimeInfo.: All data is saved in ASCII format with time information (the extension is .csv).

History Range (History)

Of the waveforms that are selected to be saved on the Trace menu, set which range of history waveforms to save.

- One: The single waveform that is specified with Select No. on the HISTORY menu* will be saved.
- All: All history waveforms within the range bounded by Start No. and End No. on the HISTORY menu* will be saved. If you search for history waveforms, and then select All, only the detected waveforms will be saved.

* The menu that appears when HISTORY is pressed

History Range One and All Settings

The history range is fixed to One or All depending on the display mode (Mode) and the type of data to be saved (Data Type) on the HISTORY menu.

Display Mode (Mode) on the HISTORY Menu	One	All	Accumulate
Binary	One or All selectable	One or All selectable	Fixed to All
Type of data to be saved (Data Type)			
ASCII	Fixed to One	Fixed to One	Fixed to One
ASCII with TimeInfo.	Fixed to One	Fixed to One	Fixed to One

Note

If Average on the HISTORY menu is set to ON, only a single set of averaged waveform data will be saved regardless of the display mode specified on the HISTORY menu, the type of data to be saved, and the history range.

Window to Be Saved and Data Compression (Range/Compression)

Press the **Range/Compression** soft key. The following menu items appear.

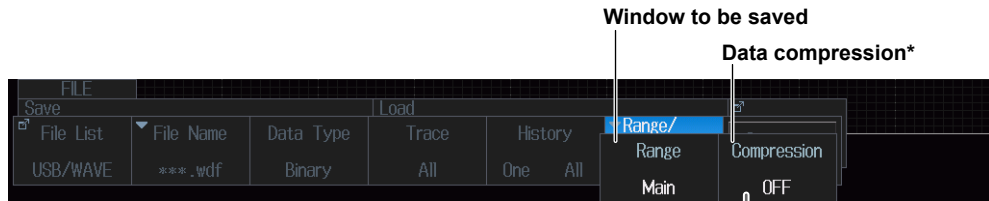

* You can set this when the window to be saved is Main.

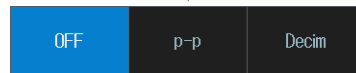

When data compression is p-p



Number of data points

When data compression is Decim

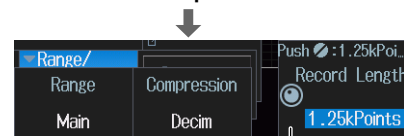

Number of data points

If the window to be saved is set to Main, you can save the waveform data by compressing or sampling it. If you want to save waveform data whose record length exceeds 1.25 Mpoints to a file in ASCII format, the data must be compressed. If the window to be saved is set to Zoom1 or Zoom2, data compression is not possible. Therefore, waveform data whose number of data points on the window to be saved exceeds 1.25 Mpoints cannot be saved to a file in ASCII format.

- OFF: All the data is saved without compression or sampling.
- P-P: The waveform data is P-P compressed so that the number of data points is equal to the specified number and then saved.
- Decim: The data is sampled (decimated) so that the number of data points is equal to the specified number and then saved.

About Data Compression and Waveform Loadability

Waveforms saved in the binary data format can be loaded to this instrument, but the possible loading destinations differ depending on the data compression setting.

Waveforms saved in the ASCII or ASCII with TimeInfo. format cannot be loaded to the instrument regardless of the data compression setting.

Waveform loading destination*		Loading Waveform Data into Channels (Load to Channels)	Loading waveform data into reference waveforms (Load to Ref1(Math1) to Load to Ref4(Math4))
Data compression (Compression)	OFF	Possible	Possible
	P-P	Not possible	Possible
	Decim	Not possible	Possible

* For details on loading waveform data, see section 17.5.

17.3 Saving Setup Data

This section explains the following settings for saving setup data:

You can save setup data to a file or to three different internal memory locations.

- Save destination
- File name
- Setting details to save to internal memory
- Saving setup data

► “Saving Setup Data (setup)” in Features Guide

File Setup (Save) Menu

1. Press **FILE**. The FILE menu appears.

You can also tap **MENU** (☰) in the upper left of the screen and select the FILE menu from FILE/PRINT on the top menu that is displayed.

2. Press the **Setup (Save)** soft key. The following menu items appear.

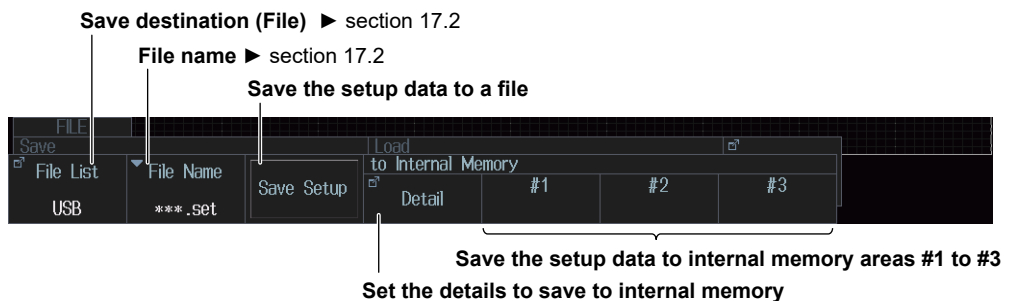

Saving Setup Data (Save Setup)

Save setup data to a file with a .set extension.

Saving Setup Data (to Internal Memory; #1 to #3)

Save setup data to internal memory areas #1 to #3.

Setting Internal Memory Details (to Internal Memory; Detail)

Press the **Detail (to Internal Memory)** soft key. The following screen appears.

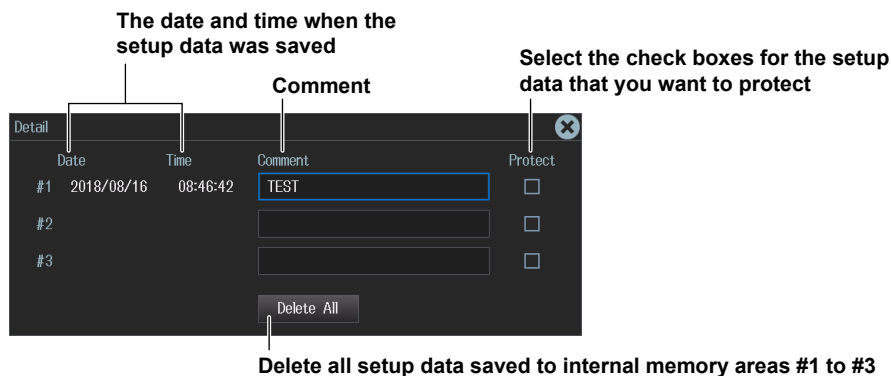

17.4 Saving Other Types of Data

This section explains the following settings for saving screen captures, waveform zone data, snapshot waveform data, automated measurement values of waveform parameters, serial bus analysis results, FFT results, histogram data, and the list of timestamps:

- Save destination
- File name
- Saved data
- Data format
- Color data
- Waveform zone number
- Serial bus
- FFT
- Histogram
- Saving Data

► “Saving Other Types of Data (Others)” in Features Guide

File Others (Save) Menu

1. Press **FILE**. The FILE menu appears.
You can also tap **MENU** (ⓘ) in the upper left of the screen and select the FILE menu from FILE/PRINT on the top menu that is displayed.
2. Press the **Others (Save)** soft key. The following menu items appear.

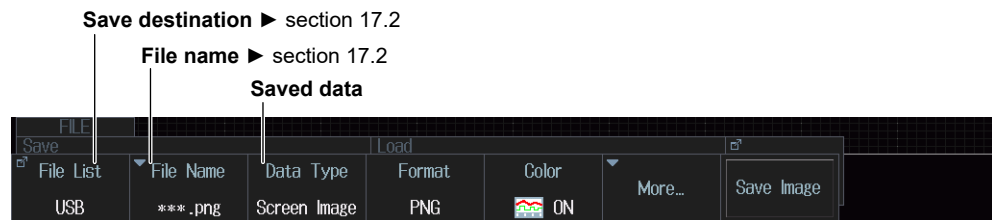

Data Type to Save (Data Type)

Screen Image: Save the display to a PNG, BMP, or JPEG file.

- You can select whether to include setting information such as channels, triggers, and waveform acquisition, in waveform screen captures. For details on screen captures that include setting information, see section 16.5.
- Screen captures that can be saved on the FILE menu are those that correspond to Normal save mode on the SHIFT+PRINT menu.

Wave-Zone: Save the waveform zone to a file with a .zwf extension.

Snap: Save the waveform data captured in a snapshot to a file with a .snp extension.

Measure: Save the results of automatic waveform parameter measurement to a file in CSV format.

Serial Bus: Save the results of the serial bus analysis specified by Serial Bus1 to Serial Bus4 to a file in CSV format.

FFT: Save the computed result specified by FFT1 or FFT2 to a file in CSV format. Up to 1.25 Mpoints of data can be saved.

- When Freq Info. is set to ON, all data is saved with frequency information.
- When Freq Info. is set to OFF, all data is saved without frequency information.

Histogram: Save the waveform or waveform parameter histogram specified by Histogram1 or Histogram2 to a file in CSV format.

History List: Save the list of timestamps to a file in CSV format.

Note

The serial bus analysis results are saved according to the settings made on the HISTORY menu. If the history mode is set to One, the analysis results of the specified record number's waveform are saved. If the history mode is set to All or Accumulate, the analysis results of all the displayed waveforms are saved.

When Data Type Is Screen Image

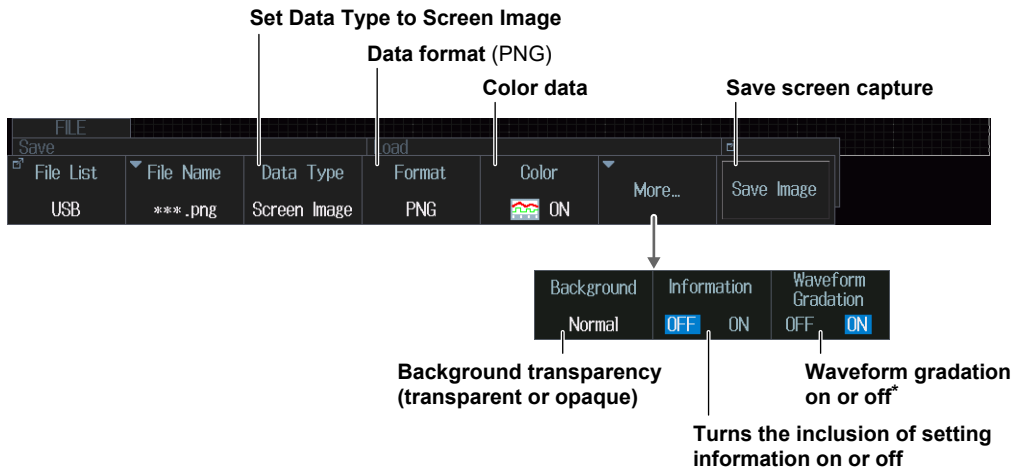

When the data format is BMP or JPEG

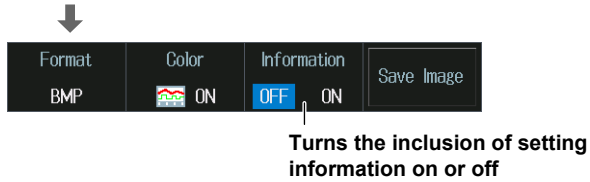

* This appears when Color data is set to ON (Rev.).

When Data Type Is Wave-Zone

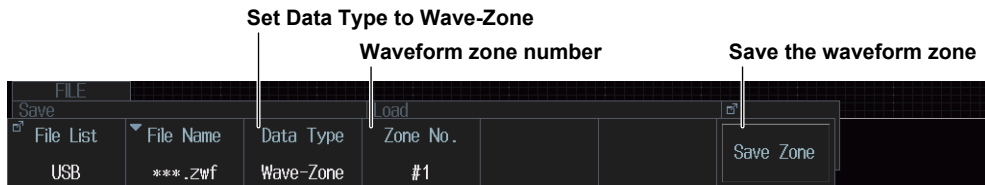

You can save waveform zones #1 to #4 to different files.

When Data Type Is Snap

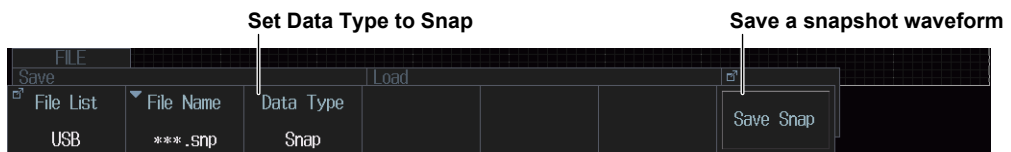

When Data Type Is Measure

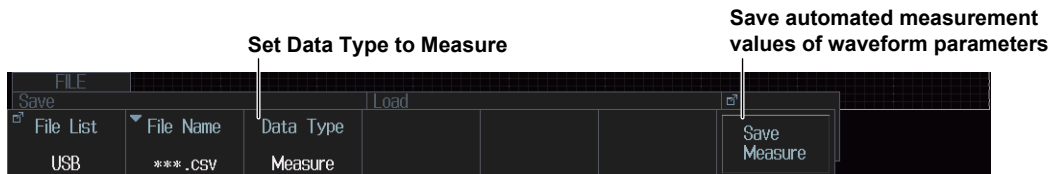

When Data Type Is Serial Bus

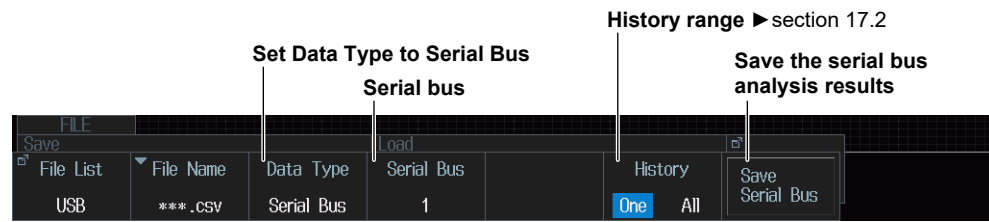

When Data Type Is FFT

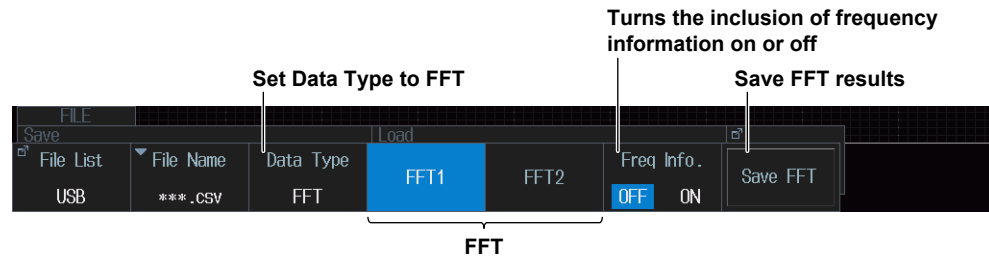

When Data Type Is Histogram

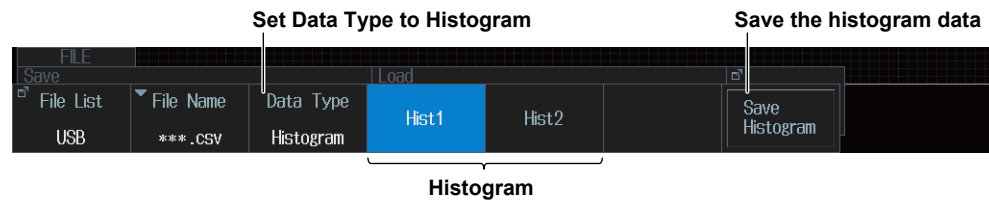

When Data Type is History List

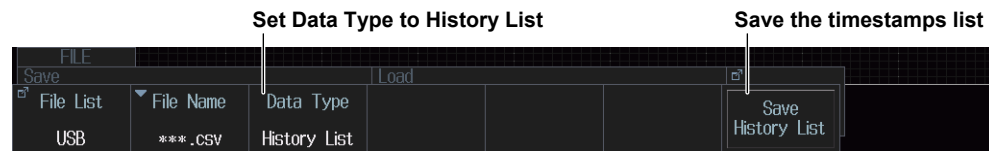

17.5 Loading Waveform Data

This section explains the following settings for loading waveform data:

- Displays the file information
- Loading waveform data into reference waveforms
- Loads waveform data into channels

► “Loading Waveform Data (Waveform)” in Features Guide

File Waveform (Load) Menu

1. Press **FILE**. The FILE menu appears.
You can also tap **MENU** (⌂) in the upper left of the screen and select the FILE menu from FILE/PRINT on the top menu that is displayed.
2. Press the **Waveform (Load)** soft key. The following screen and menu items appear.

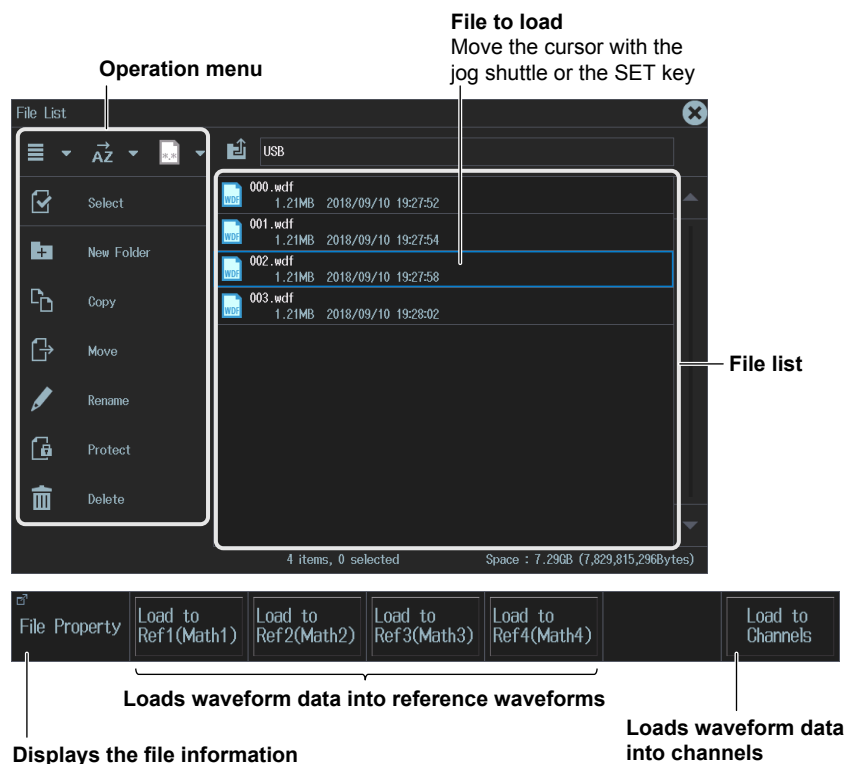

Selecting Files

Select the file to load from the file list. ► section 17.8

Loading Waveform Data into Reference Waveforms (Load to Ref1(Math1), Load to Ref2 (Math2), Load to Ref3 (Math3), Load to Ref4 (Math4))

You can specify waveform data files that have the .wdf extension and load them as reference waveforms. Reference waveforms are treated as part of the computation feature. You can display reference waveforms by specifying Ref in a mode from Math/Ref 1 to Math/Ref 4.

Loading Waveform Data into Channels (Load to Channels)

You can specify waveform data files that have .wdf extensions and load them with setup data. Loaded data is cleared when you start measurement.

Note

To load a file saved from the waveform data of multiple channels as a reference waveform, use Load to Channels to load the waveform into channels, and then load the waveform as a computation reference waveform (see section 6.7).

17.6 Loading Setup Data

This section explains the following settings for loading setup data:

Both the method for loading setup data that has been saved to a file and the method for loading setup data that has been saved in the internal memory are explained.

- Displaying file information
- Internal memory details
- Loading setup data

► “Loading Setup Data (Setup)” in the Features Guide

File Setup (Load) Menu

1. Press **FILE**. The FILE menu appears.
You can also tap **MENU** (MENU) in the upper left of the screen and select the FILE menu from FILE/PRINT on the top menu that is displayed.
2. Press the **Setup (Load)** soft key. The following menu items appear.

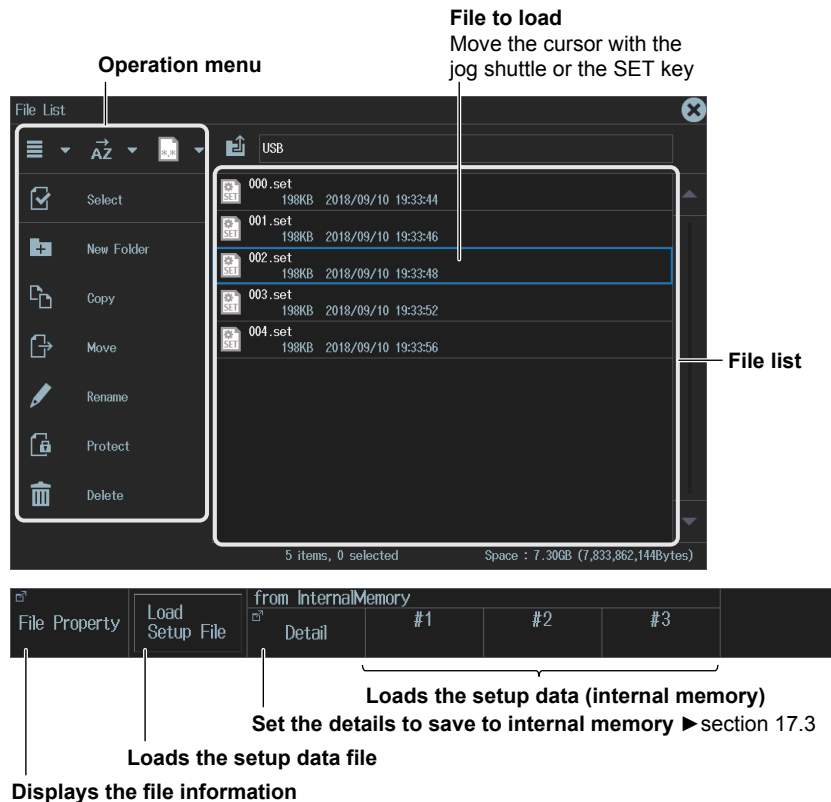

Selecting Files

Select the file to load from the file list. ► section 17.8

Loading Setup Data (Load Setup File)

Select a setup data file that has the .set extension and load it.

Loading Setup Data (from InternalMemory; from #1 to #3)

Load setup data from internal memory areas #1 to #3.

17.7 Loading Other Types of Data

This section explains the following settings for loading waveform zones, polygonal zones, snapshot waveforms, or serial bus waveform symbol data:

- Displaying file information
- Data type to load
- Loading data

► “Loading Other Types of Data (Others)” in Features Guide

File Others (Load) Menu

1. Press **FILE**. The FILE menu appears.
You can also tap **MENU** (MENU) in the upper left of the screen and select the FILE menu from FILE/PRINT on the top menu that is displayed.
2. Press the **Others (Load)** soft key. The following menu items appear.

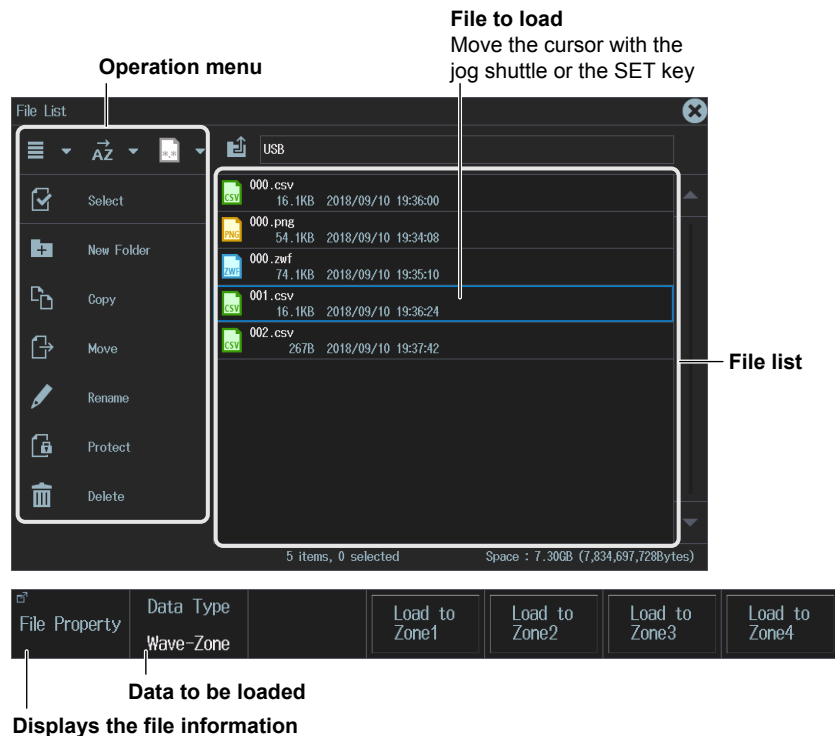

Selecting Files

Select the file to load from the file list. ► section 17.8

Data Type to Load (Data Type)

- Wave-Zone:** Load waveform zone files that have the .zwf extension that you created on the instrument into internal memory areas Zone1 to Zone4.
- Polygon-Zone:** Load polygonal zone files that have the .msk extension that you created with the Mask Editor software into internal memory areas Zone1 to Zone4.
- Snap:** Load snapshot waveform files that have the .snp extension that you have saved.
- Symbol:** Load physical value/symbol definition files that have the .sbl extension that you have edited using the Symbol Editor tool.

When Data Type Is Wave-Zone

Set Data Type to Wave-Zone.

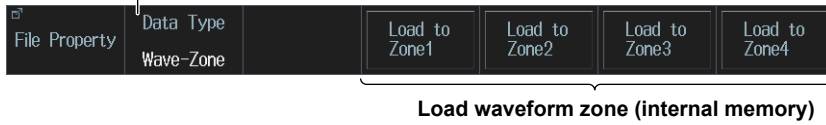

When Data Type Is Polygon-Zone

Set Data Type to Polygon-Zone

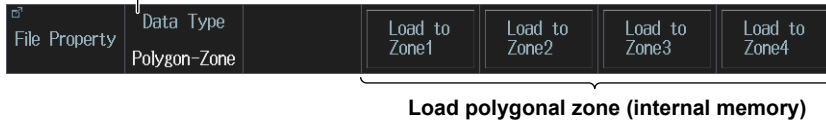

When Data Type Is Snap

Set Data Type to Snap

Load snapshot waveforms



When Data Type Is Symbol

Set Data Type to Symbol

Load serial bus waveform symbol data



17.8 Performing File Operations

This section explains the following settings for performing various file operations from the file list or the file utility menu:

File list

- Display format
- Sorts the file list
- Displays one level up
- Filter the files to display
- Selecting multiple files or folders (All Set/All Reset and Set/Reset)
- Create folders (directories).
- Copy files and folders.
- Move files and folders.
- Rename files and folders.
- Turning file protection on and off
- Delete files and folders.

FILE Utility Menu

- Displaying file information
- Turning file protection on and off
- Selecting multiple files or folders (All Set/All Reset and Set/Reset)

► [“File Operations \(Utility\)” in Features Guide](#)

File List (File List)

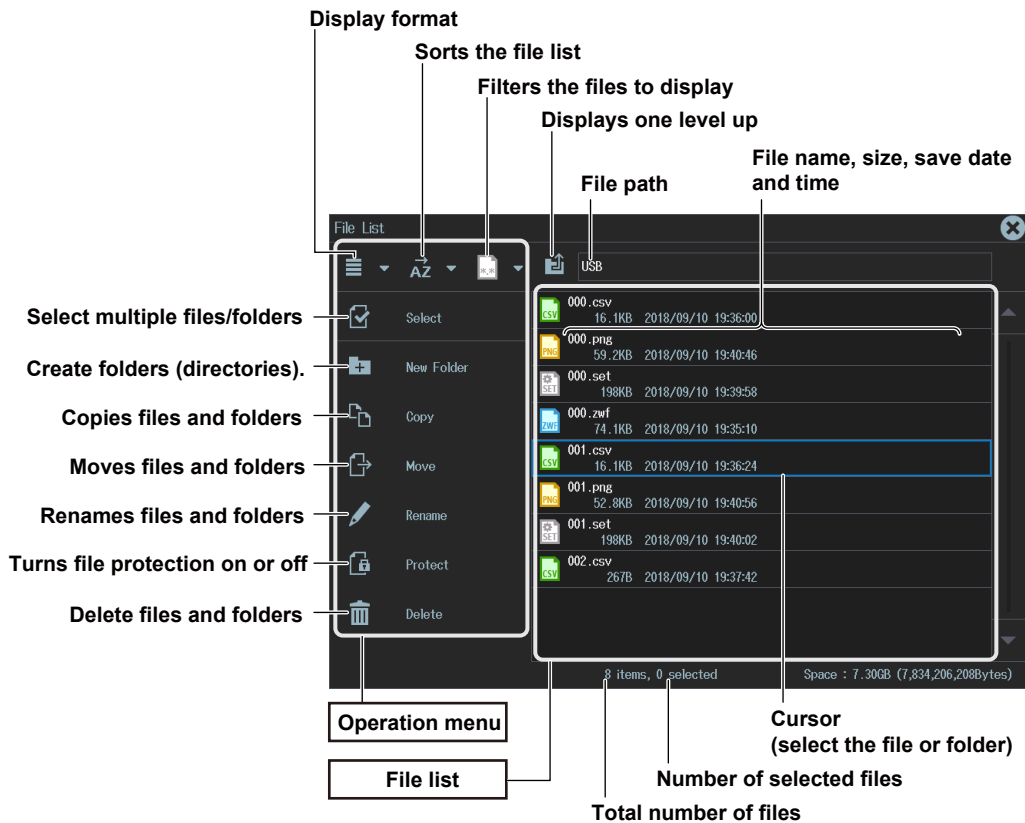

Switching Between the Operation Menu and the File List

- Tilt **SET** (●) to the left to move the cursor to the operation menu. Tilt it to the right to move the cursor to the file list.
- To move the cursor between **☰***, **AZ***, and **⬆***, tilt the **SET** key to the left or right.
 - * The icon varies depending on the selected menu item.
- To move the cursor to the **⬆** (display one level up), move the cursor to the top of the file list, then tilt **SET** up.

Selecting the Operation Target (File List)

When Operating a File or Folder

1. Turn the **jog shuttle** or move **SET** (●) up and down to move the cursor to the file or folder you want to select.
A blue frame appears around the selected file or folder.
2. To display inside of a folder, move the cursor to the folder and press **SET** (●).
To return to the original level, move the cursor to  (display one level up) and press **SET**.

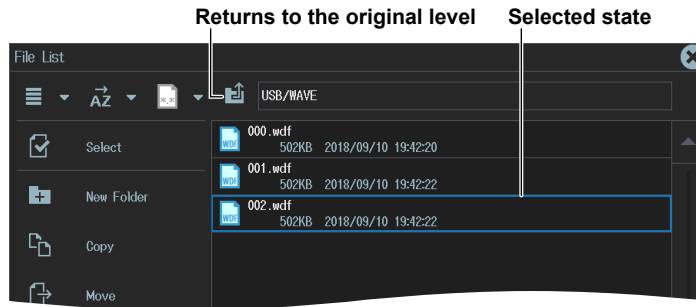

When Operating Multiple Files and Folders (Select)

1. Display the content of a drive or folder that contains multiple files or folders that you want to select.
2. Select **Select** (☑) on the operation menu and press **SET**. The following screen appears.
The cursor moves to the file list.

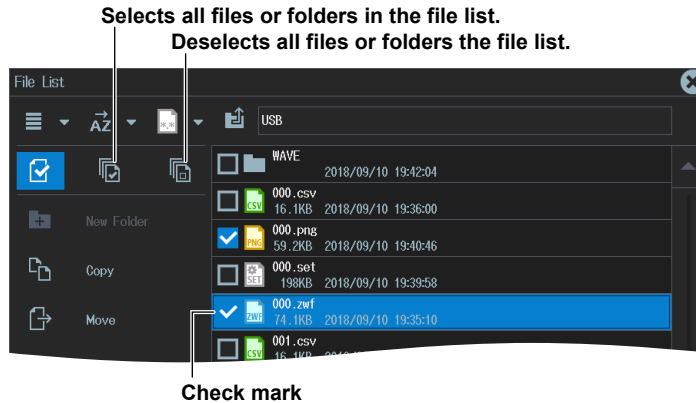

3. Move the cursor to a file or folder that you want to select on the file list.
4. Press **SET** (●).
 - A check mark is displayed next to the selected file or folder.
 - Press **SET** again to remove the check mark.
5. Repeat steps 3 and 4 to select all the files and folders you want.
 - To select all or deselect all, move the cursor to the operation menu, select **Select All** (☑) or **Deselect All** (☐), and then press **SET**.
 - To close the multiple selection screen, move the cursor to the operation menu, select **Select** (☑) and press **SET**. Multiple selection will be canceled.

Selecting the Operation Content (Operation Menu)

1. Turn the **jog shuttle** or move **SET** (●) up and down to move the cursor to the menu item you want to use.
2. Press **SET** (●).
 - The screen for the selected item appears.
 - To return to the previous screen, press **ESC**.

Display Format (☰)

Select ☰* from the operation menu and press **SET**. The following screen appears.

* The icon will change according to the currently selected display format.

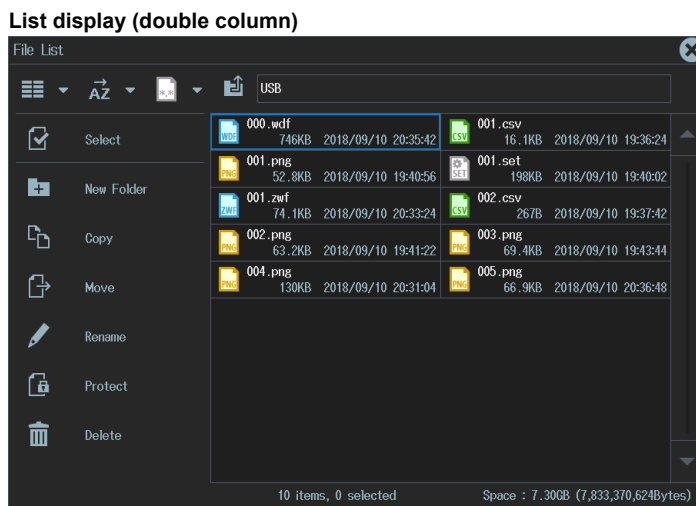
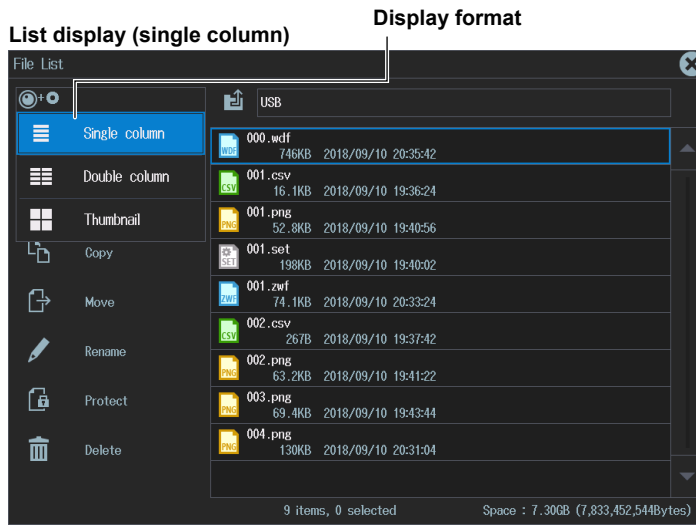

17.8 Performing File Operations

Sorting the File List (AZ)

Select **AZ** from the operation menu and press **SET**. The following screen appears.

* The icon will change according to the current sort order.

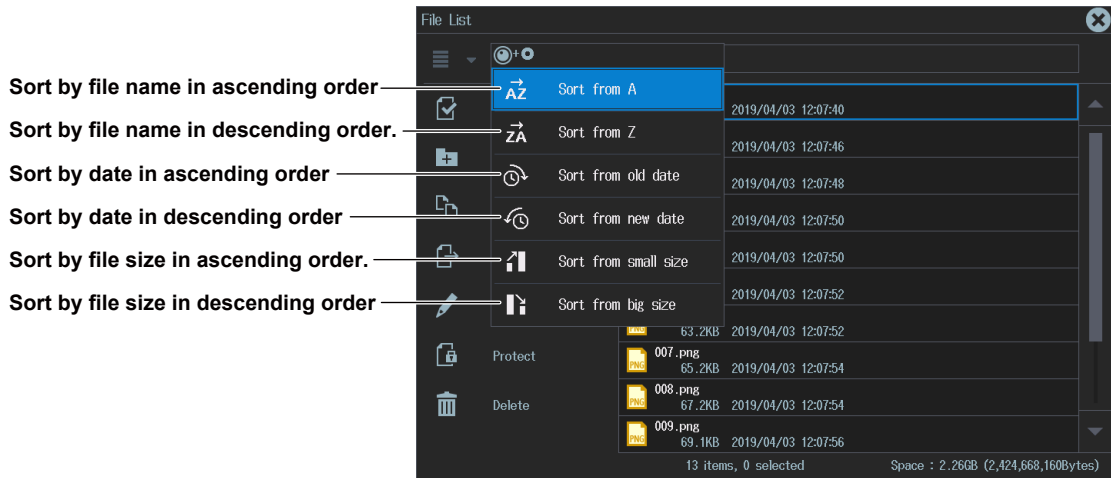

Filtering the Files to Display (File Type Icon)

On the operation menu, select **File Type Icon**, and press **SET**. The following screen appears.

* The icon varies depending on the selected file type.

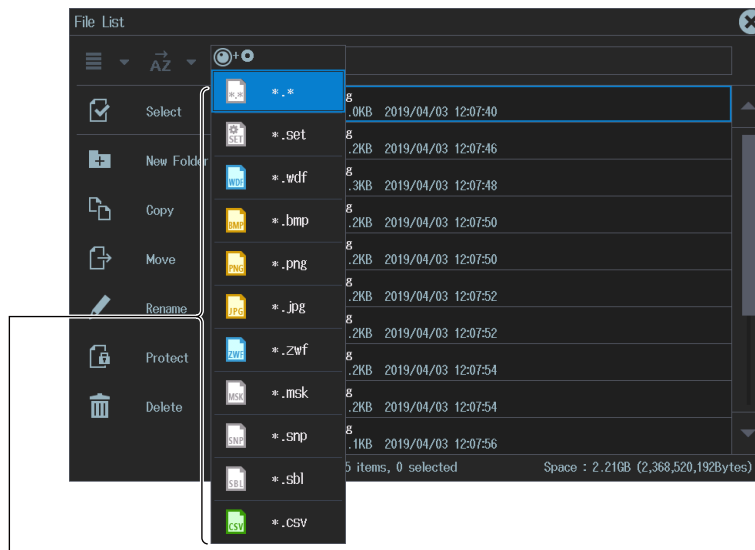

Select the type of files to display in the file list.

- *.*: All files
- *.set: Setup files
- *.wdf: Waveform files
- *.bmp: Image files (BMP)
- *.png: Image files (PNG)
- *.jpg: Image files (JPEG)
- *.zwf: Waveform zone files
- *.msk: Polygonal zone files
- *.snp: Snapshot waveform files
- *.sbl: Symbol definition files
- *.csv: CSV files

Displaying one level up (⬆)

Select ⬆, and press **SET**. The next higher level is displayed on the file list.
By displaying the highest level, you can change the storage device.

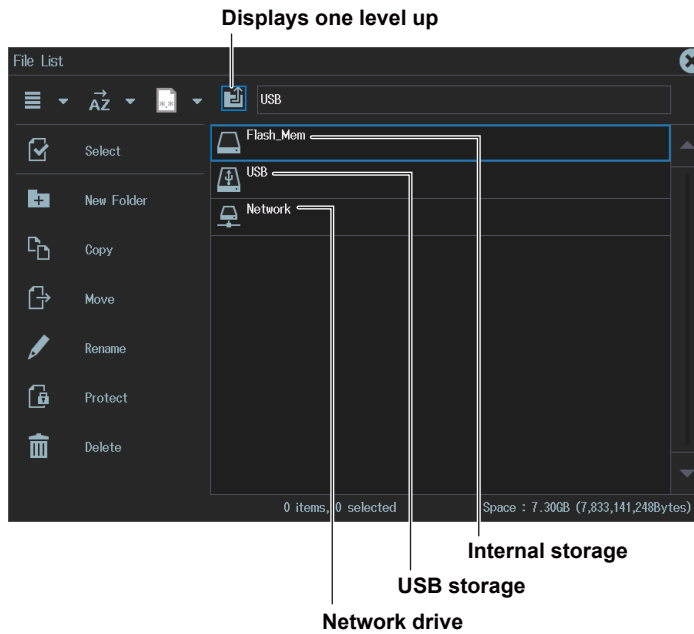

Making Folders (Directories) (New folder)

1. Create a folder and display the content of the drive or folder on the file list.
2. Select **New Folder** from the operation menu and press **SET**. The following screen appears.

Use the keyboard to enter the new folder name.

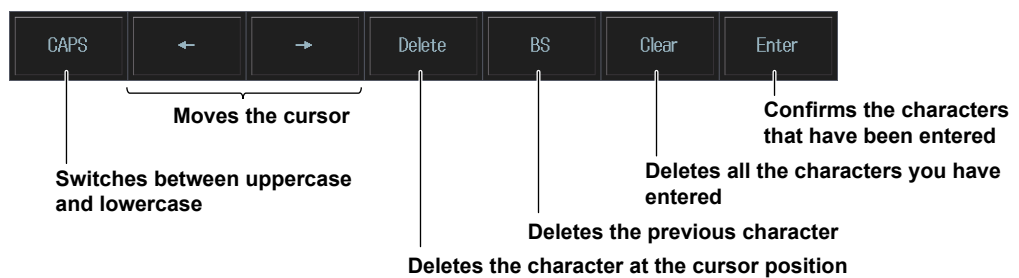

Copying Files and Folders (Copy)

1. Select the files and folders in the file list that you want to copy.
2. Select **Copy** from the operation menu and press **SET**. The following screen appears.

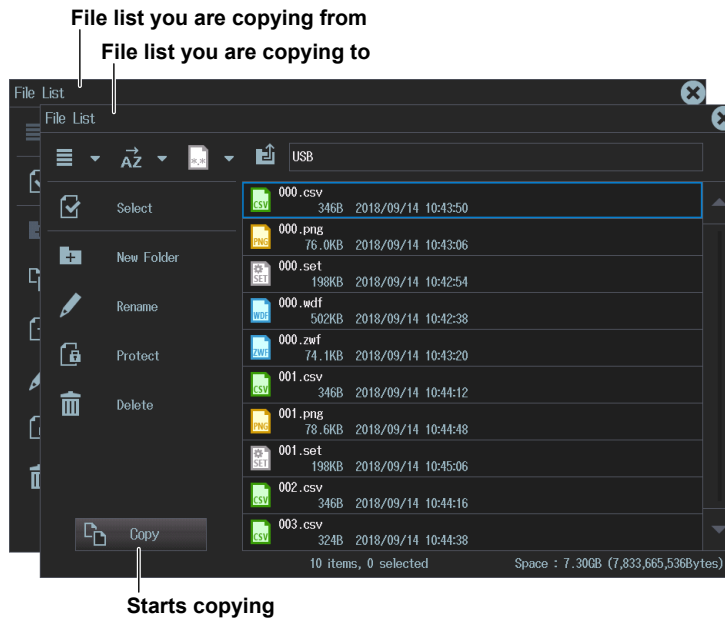

3. Select the drive or folder on the file list that you are copying to.
4. Tilt **SET** to the left and go to the copy destination operation menu.
5. Select **Copy** and press **SET**. The files or folders are copied.

Note

- By selecting multiple files, you can copy them all at the same time. For details on how to select multiple files, see page 17-16.
 - You can perform file operations on the file list that you are copying to as well.
-

Moving Files and Folders (Move)

1. Select the files and folders in the file list that you want to move.
2. Select **Move** from the operation menu and press **SET**. The following screen appears.

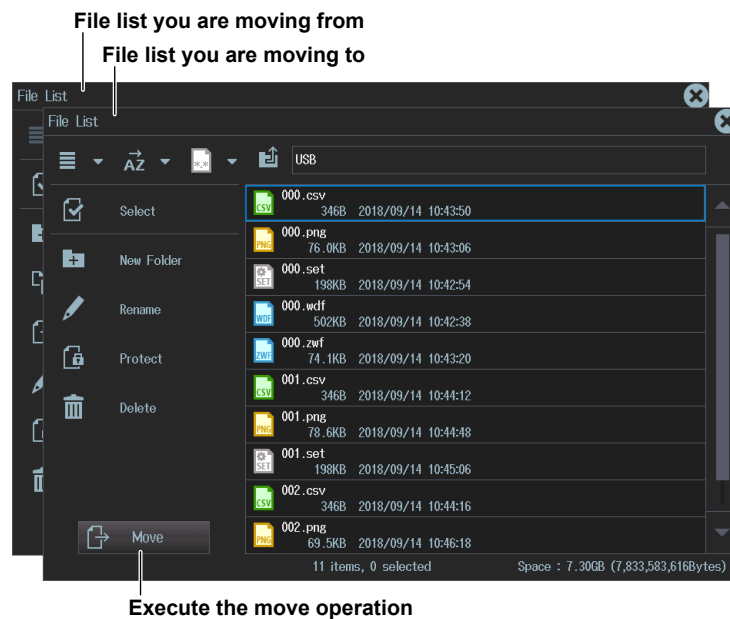

3. Select the drive or folder in the file list that you are moving to.
4. Tilt **SET** to the left and go to the move destination operation menu.
5. Select **Move** and press **SET**. The files or folders are moved.

Note

- By selecting multiple files, you can move them all at the same time. For details on how to select multiple files, see page 17-16.
- You can perform file operations on the file list that you are moving files to as well.

Renaming Files and Folders (Rename)

1. Select the file or folder that you want to rename from the file list.
2. Select **Rename** from the operation menu and press **SET**. The following screen appears.

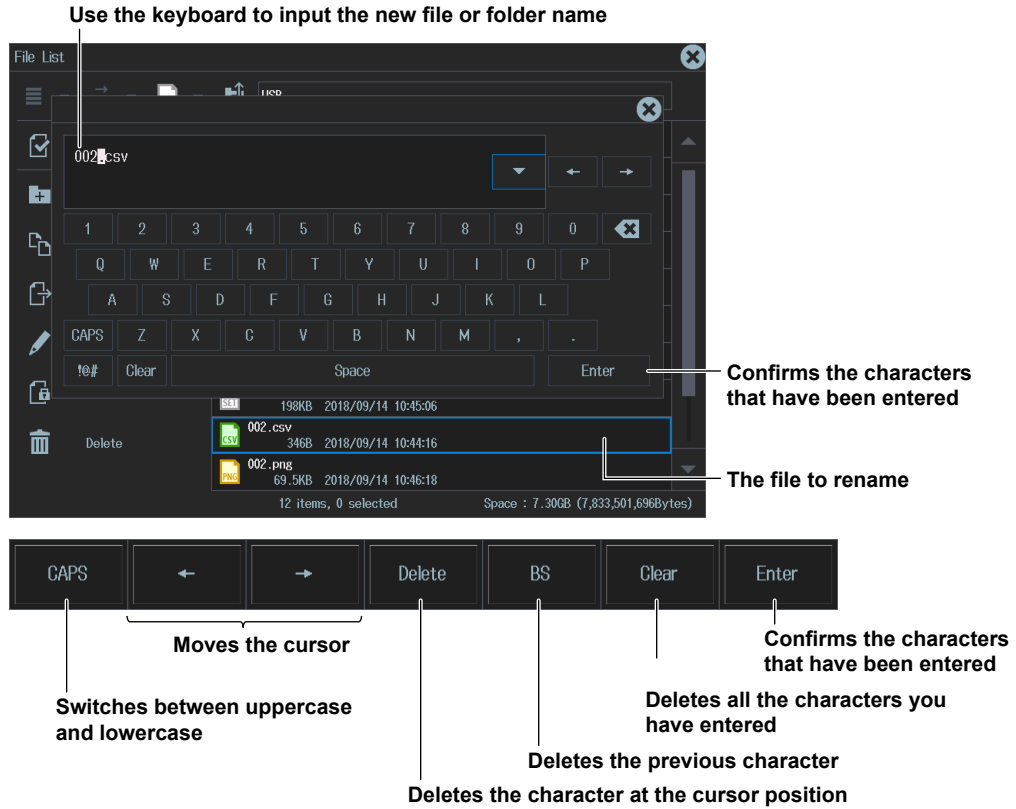

Deleting Files and Folders (Delete)

1. Select the file or folder that you want to delete from the file list.
2. Select **Delete** from the operation menu and press **SET**. The following screen appears.

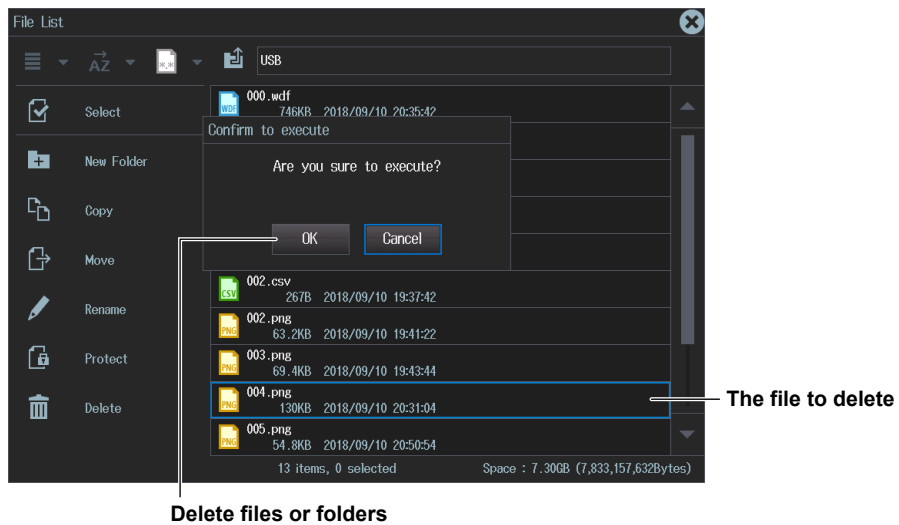

Note

By selecting multiple files, you can delete them all at the same time. For details on how to select multiple files, see page 17-16.

File Utility Menu

1. Press **FILE**. The FILE menu appears.
You can also tap **MENU** (Ⓜ) in the upper left of the screen and select the FILE menu from FILE/PRINT on the top menu that is displayed.
2. Press the **Utility** soft key. The following menu items appear.



Display file information

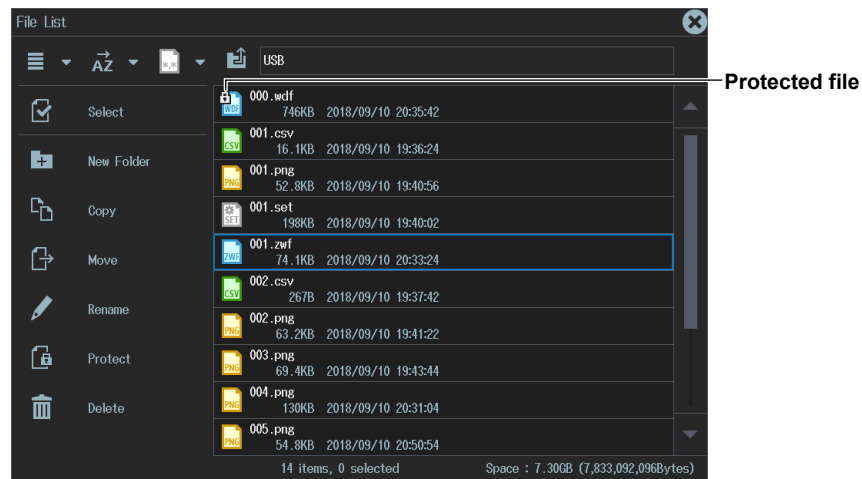

Turning Protection On or Off (Protect ON/OFF)

You can set protection of selected files on or off.

Protection	Description
ON	File protection is on for the selected file. The file can be read from. Writing is not allowed. Deleting is also not allowed.
OFF	File protection is off for the selected file. The file can be read and written.

All Set/All Reset

This is the same function as Select All (☑️)/Deselect All (☐️) in Select (☑️) (page 17-16) of the operation menu.

All Set: Select all the files. A check mark is displayed next to each of the selected files.

All Reset: Deselect all the files.

Set/Reset

Invert the selection status of the file highlighted by the cursor. This is the same function as when Select (☑️) (page 17-16) of the operation menu is selected. A check mark is displayed next to each of the selected files.

Note

File protection can also be turned on or off on the operation menu.

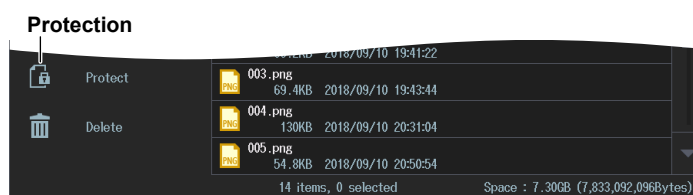

18.1 Connecting the Instrument to a Network

This section explains how to connect the instrument to a network.

Ethernet Interface Specifications

There is a 1000BASE-T port located on the rear panel of the instrument.

Item	Specifications
Ports	1
Electrical and mechanical specifications	IEEE802.3 compliant
Transmission system	Ethernet(1000BASE-T/100BASE-TX/10BASE-T)
Communication protocol	TCP/IP
Supported services	Server: FTP, VXI-11, and Socket Client: FTP (Net Drive), SMTP (Mail), SNMP, LPR (Net Print), DHCP, and DNS
Connector type	RJ-45 connector

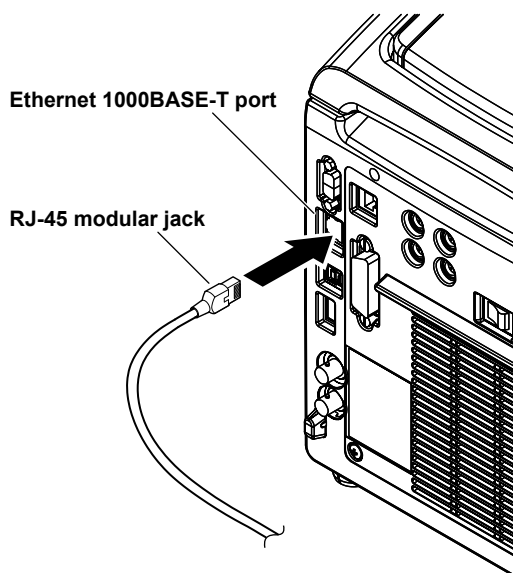

Items Required to Connect the Instrument to a Network

Cable

Use a network cable appropriate for the data rate of your network.

Connection Method

To Connect to a PC over a Network

1. Turn off the instrument.
2. Connect one end of an Ethernet cable to the ETHERNET 1000BASE-T port on the rear panel.
3. Connect the other end of the Ethernet cable to a hub or router.
4. Turn on the instrument.

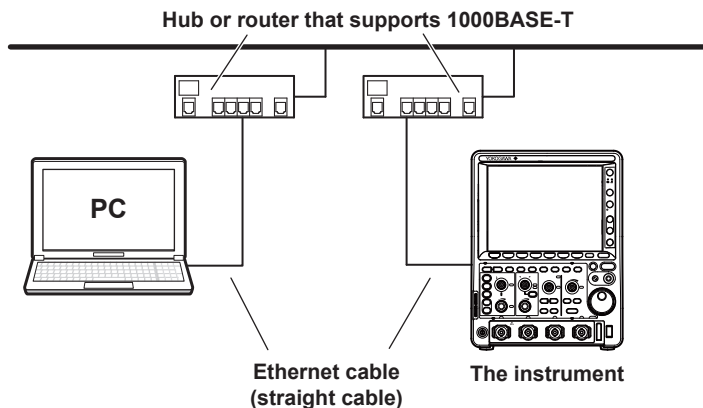

To Connect to a PC through a Hub or Router

1. Turn off the instrument and the PC.
2. Connect one end of an Ethernet cable to the ETHERNET 1000BASE-T port on the rear panel.
3. Connect the other end of the Ethernet cable to a hub or router.
4. Connect the PC to the hub or router in the same way.
5. Turn on the instrument.

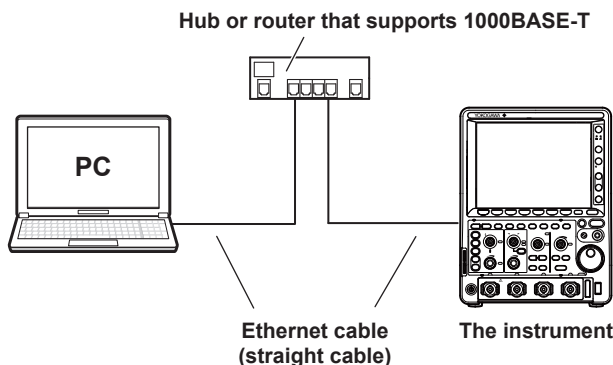

Note

- Use a hub or router that conforms to the transfer speed of your network.
 - When you connect a PC to the instrument through a hub or router, the PC must be equipped with an auto-switching 1000BASE-T/100BASE-TX/10BASE-T network card.
 - Do not connect the instrument to a PC directly. Direct communication without a hub or router is not guaranteed to work.
-

18.2 Configuring TCP/IP Settings

This section explains the following TCP/IP settings for connecting to a network:

- DHCP (IP address, subnet mask, and default gateway)
- DNS (domain name, DNS server IP address, and domain suffix)

▶ “TCP/IP (TCP/IP)” in the Features Guide

UTILITY Network Menu

1. Press **UTIL**. The UTILITY menu appears.
You can also tap **MENU** (ⓘ) in the upper left of the screen and select the UTILITY menu from UTILITY on the top menu that is displayed.
2. Press the **Network** soft key. The following menu items appear.

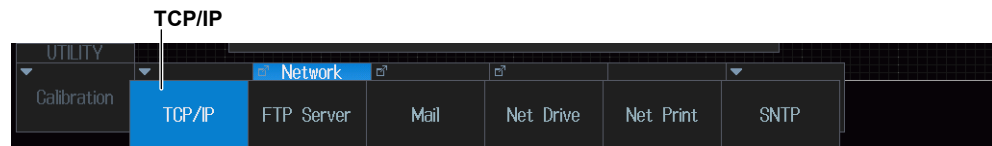

TCP/IP(TCP/IP)

Press the **TCP/IP** soft key. The following screen appears.

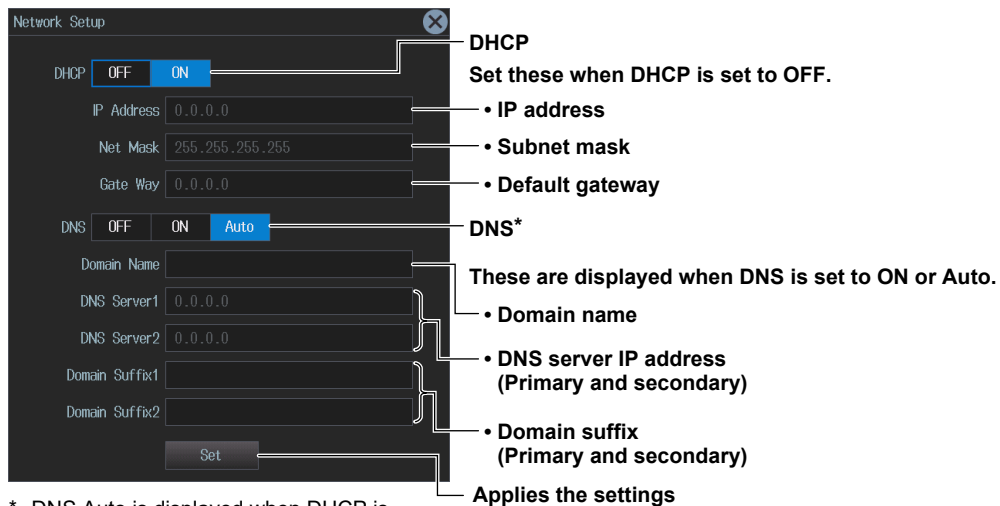

* DNS Auto is displayed when DHCP is set to ON.

DNS(DNS)

OFF: Disable the DNS.

ON: DNS is enabled. Set the domain name, the DNS server IP address, and the domain suffix.

Auto: DNS is enabled. Set the domain suffix. The domain name and the DNS server IP addresses are set automatically. This option can only be selected when DHCP is on.

18.3 Accessing the instrument from a PC (FTP Server)

This section explains the following settings for accessing the instrument from a PC on a network:

- User name
- Password
- Timeout
- Executing FTP client software

► “FTP Server (FTP Server)” in Features Guide

UTILITY Network Menu

1. Press **UTIL**. The UTILITY menu appears.
You can also tap **MENU** (MENU) in the upper left of the screen and select the UTILITY menu from UTILITY on the top menu that is displayed.
2. Press the **Network** soft key. The following menu items appear.

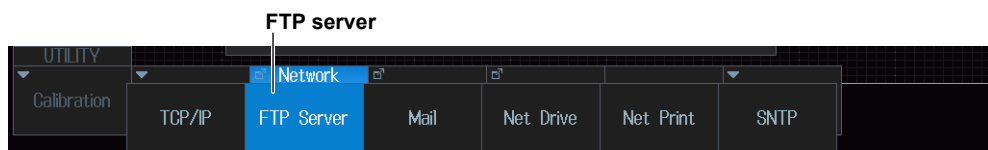

FTP Server (FTP Server)

Press the **FTP Server** soft key. The following screen appears.

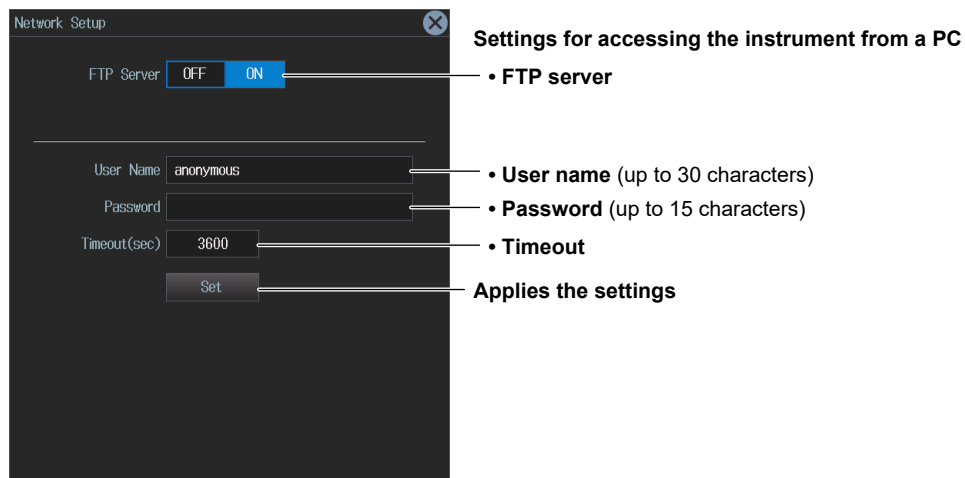

Executing FTP Client Software (Set)

Start an FTP client on a PC.

Enter the user name and password that you set on the instrument's network setup screen, which is shown above, and connect to the instrument.

Note

If you set the user name to “anonymous,” you can connect to the instrument without entering a password.

18.4 Configuring Mail Transmission (SMTP Client Function)

This section explains the following settings for transmitting mail to a specified mail address on a network:

- Mail server
- Mail address
- Comments
- Attaching image files
- Timeout
- User authentication
- Sending a test mail

► “Mail (Mail)” in Features Guide

UTILITY Network Menu

1. Press **UTIL**. The UTILITY menu appears.
You can also tap **MENU** (MENU) in the upper left of the screen and select the UTILITY menu from UTILITY on the top menu that is displayed.
2. Press the **Network** soft key. The following menu items appear.

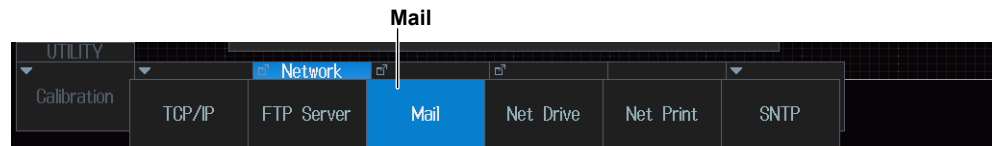

Mail (Mail)

Press the **Mail** soft key. The following screen appears.

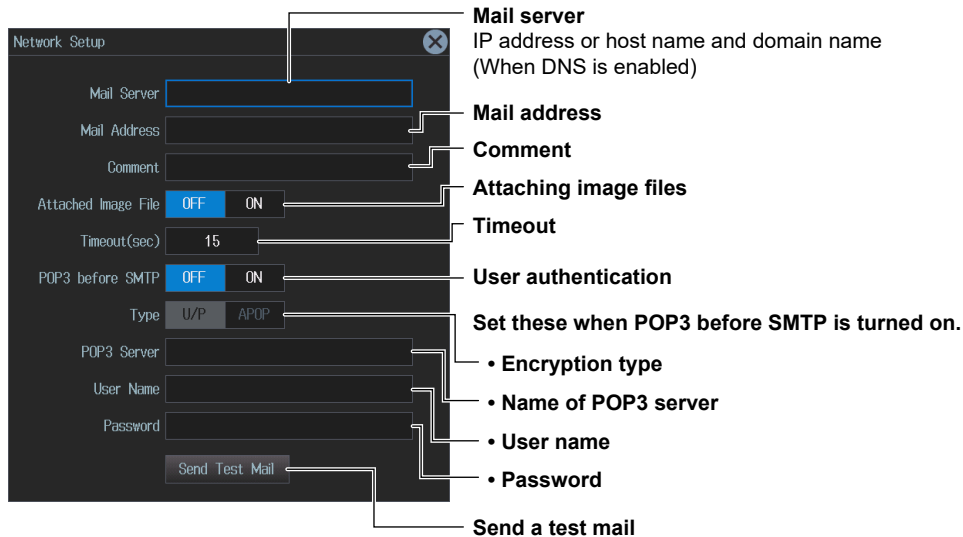

18.5 Connecting to a Network Drive

This section explains the following settings for accessing a drive on the network (net drive) through an Ethernet connection to load or save various data of the instrument:

- FTP server (file server)
- User name
- Password
- FTP passive mode
- Timeout
- Connecting to and disconnecting from network drives

► “Network Drive (Net Drive)” in the Features Guide

UTILITY Network Menu

1. Press **UTIL**. The UTILITY menu appears.
You can also tap **MENU** (MENU) in the upper left of the screen and select the UTILITY menu from UTILITY on the top menu that is displayed.
2. Press the **Network** soft key. The following menu items appear.

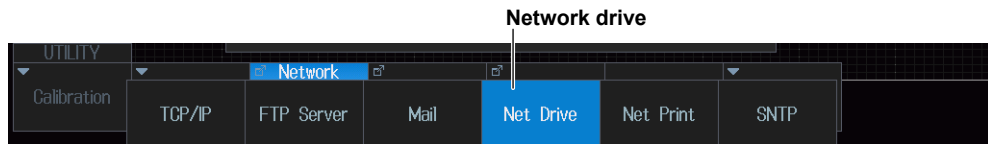

Configuring Network Drive (Net Drive) Settings and Connecting to It

Press the **Net Drive** soft key. The following screen appears.

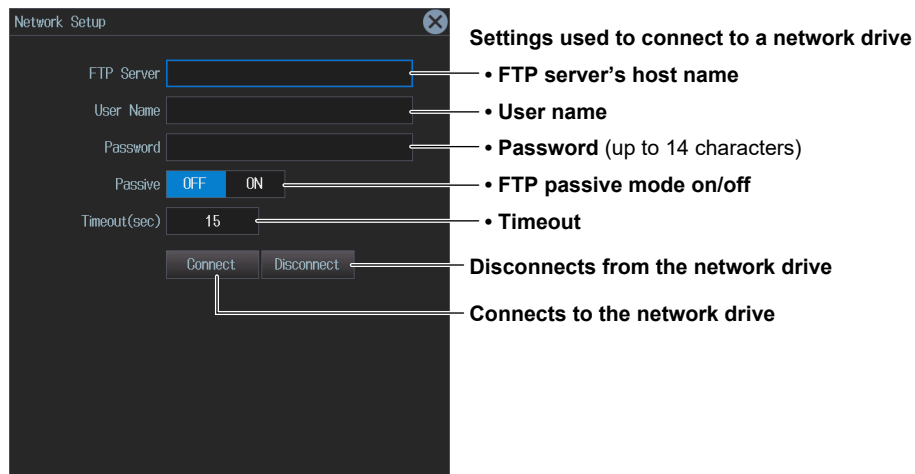

18.6 Configuring a Network Printer

This section explains the following settings for printing screen images to a network printer:

- LPR server
- LPR name
- Timeout

► “Network Printer (Net Print)” in the Features Guide

UTILITY Network Menu

1. Press **UTIL**. The UTILITY menu appears.
You can also tap **MENU** (ⓘ) in the upper left of the screen and select the UTILITY menu from UTILITY on the top menu that is displayed.
2. Press the **Network** soft key. The following menu items appear.

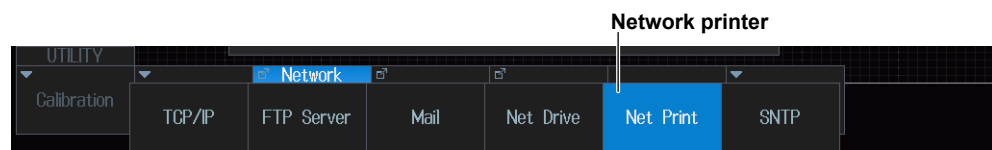

Network Printer (Net Print)

Press the **Net Print** soft key. The following screen appears.

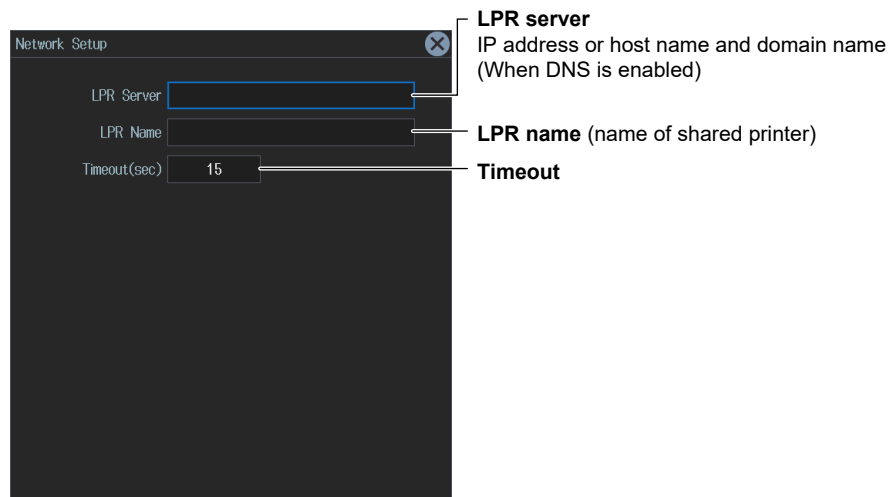

18.7 Using SNTP to Set the Date and Time

This section explains how to use SNTP to set the Instrument's date and time.

- SNTP server
- Timeout
- Executing time adjustment
- Automatic adjustment

► “SNTP (SNTP)” in the Features Guide

UTILITY Network Menu

1. Press **UTIL**. The UTILITY menu appears.
You can also tap **MENU** (E) in the upper left of the screen and select the UTILITY menu from UTILITY on the top menu that is displayed.
2. Press the **Network** soft key. The following menu items appear.

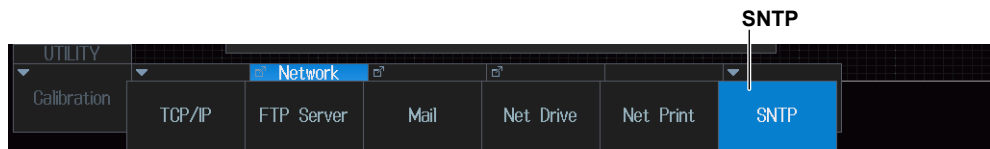

SNTP(SNTP)

Press the **SNTP** soft key. The following screen appears.

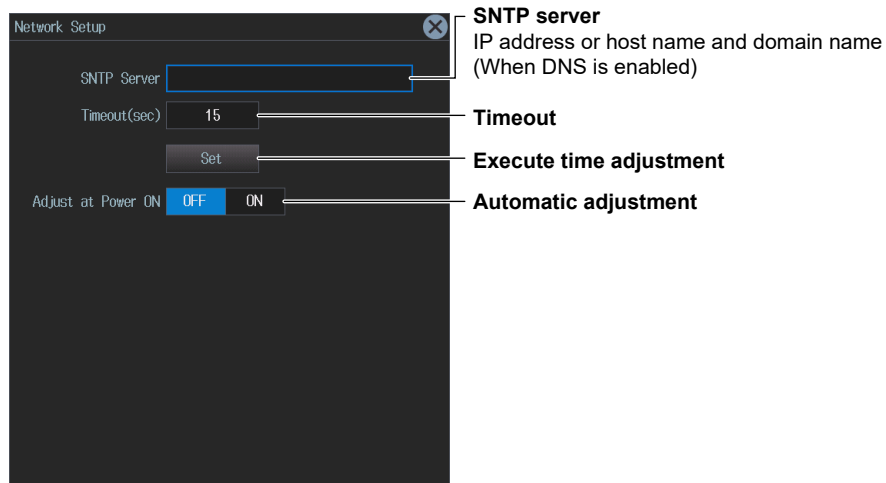

19.1 Changing the Menu, Message, and USB Keyboard Languages

This section explains how to set the menu language, message language and USB keyboard language of the instrument.

► [“Language \(Language\)” in Features Guide](#)

UTILITY System Configuration Menu

1. Press **UTIL**. The UTILITY menu appears.
You can also tap **MENU** () in the upper left of the screen and select the UTILITY menu from UTILITY on the top menu that is displayed.
2. Press the **System Configuration** soft key. The following menu items appear.

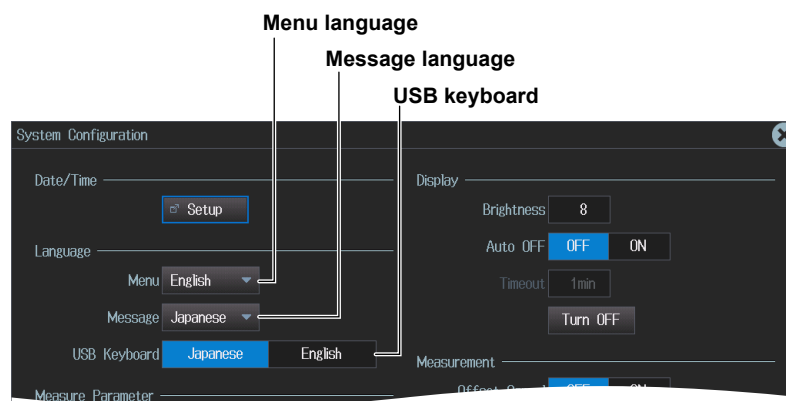

Note

Some terminology is always displayed in English.

USB Keyboard (USB Keyboard)

You can use the following keyboards that conform to USB Human Interface Devices (HID) Class Ver. 1.1.

English: 104-key keyboards

Japanese: 109-key keyboards

For details on how the keys of this instrument are mapped to the keys on a USB keyboard, see Appendix 2 in the *Getting Started Guide* (IM DLM3054-03EN).

19.2 Setting the Click Sound, Measured Value Font Size, and Number of Rows for Displaying Measurement Values

This section explains the following settings:

- Turning the click sound on or off
- Measured value font size
- Number of rows for displaying measured values

► “Measurement Display (Measure Parameter)” and “Turning On or Off the Click Sound (Click Sound)” in the Features Guide

UTILITY System Configuration Menu

1. Press **UTIL**. The UTILITY menu appears.
You can also tap **MENU** (E) in the upper left of the screen and select the UTILITY menu from UTILITY on the top menu that is displayed.
2. Press the **System Configuration** soft key. The following menu items appear.

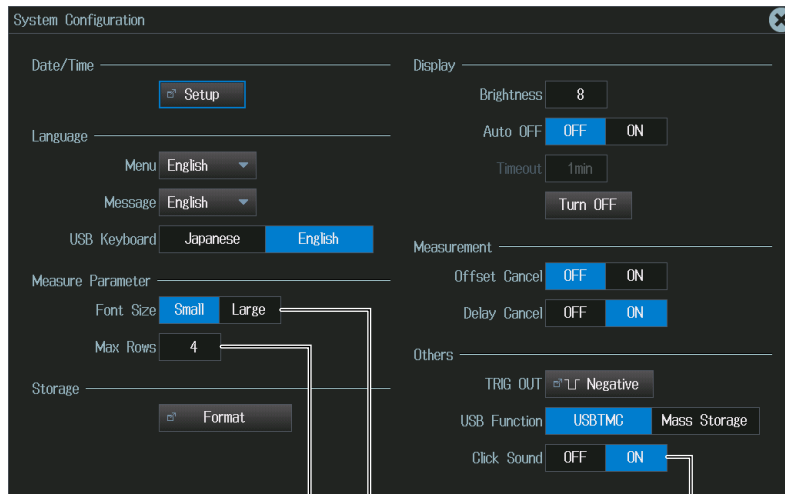

Measured value font size
Number of rows for displaying measured values
Turns the click sound on or off

19.3 Viewing Setup Information (Overview)

This section explains how to view the current setup information.

► [“Overview \(Overview\)” in the Features Guide](#)

UTILITY Overview Menu

1. Press **UTIL**. The UTILITY menu appears.

You can also tap **MENU** (ⓘ) in the upper left of the screen and select the UTILITY menu from UTILITY on the top menu that is displayed.

2. Press the **Overview** soft key. The following menu items appear.

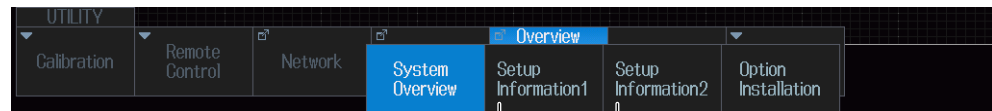

Display of Setup Information 2

Display of Setup Information 1

Displaying Setup Information 1 (Setup Information1)

Press the **Setup Information1** soft key. The following screen appears.

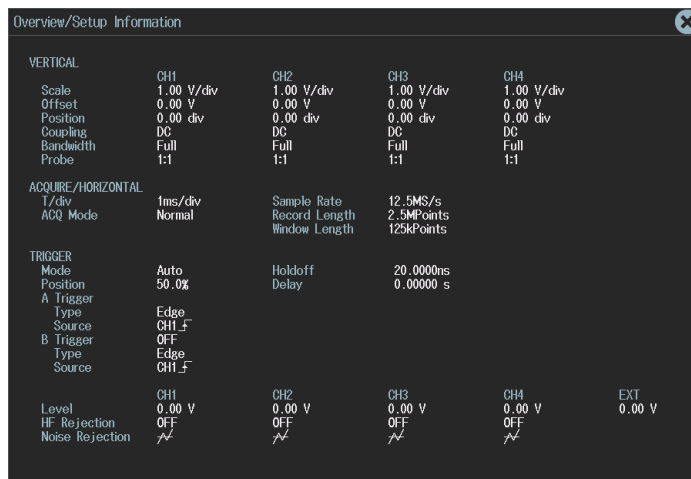

Displaying Setup Information 2 (Setup Information2)

Press the **Setup Information2** soft key. The following screen appears.

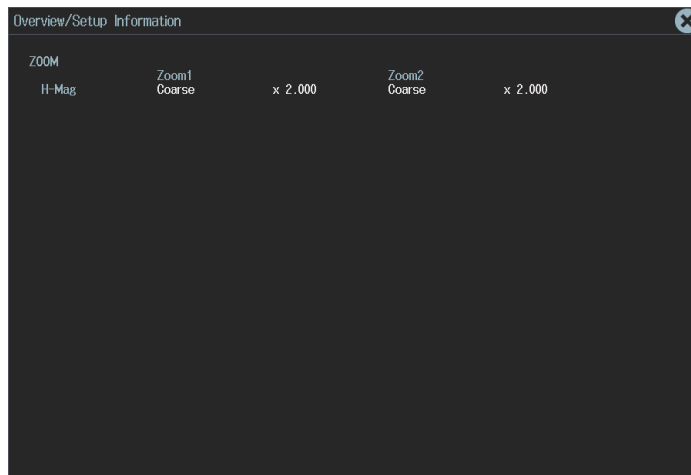

19.4 Using the Instrument as a USB Storage Device

This section explains the setting that enables you to use the instrument as a USB storage device through a USB connection made between the USB port on the instrument's rear panel and a PC.

► “USB Communication (USB Function)” in the Features Guide

UTILITY System Configuration Menu

1. Press **UTIL**. The UTILITY menu appears.
You can also tap **MENU** (MENU) in the upper left of the screen and select the UTILITY menu from UTILITY on the top menu that is displayed.
2. Press the **System Configuration** soft key. The following menu items appear.

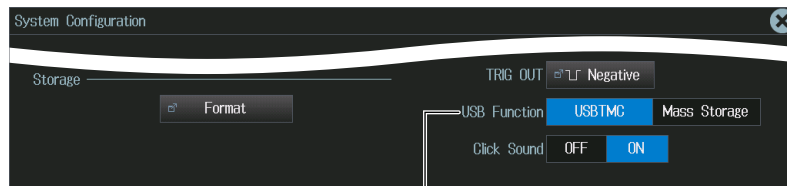

Set USB Function to Mass Storage

Note

- From a PC, you can access the instrument's internal storage as a storage device. You cannot access the instrument's network drives or the storage device connected to the instrument's USB ports.
- Mass Storage functions as a read-only storage device.
- When you perform file operations in the internal storage with this instrument, the content of the internal storage of the instrument displayed on the PC is updated. During updating, the display on the PC may momentarily disappear.
- The USB communication function (USB Function) can also be set in Remote Control from the UTILITY menu. The setting values are linked with the settings on the System Configuration menu.

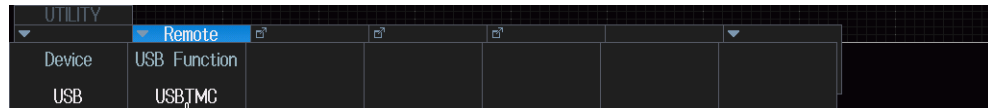

USB Function

Index

Symbols

ΔT cursor	8-1
ΔT&ΔV cursor	8-3
ΔV cursor	8-2

Numerics

1000BASE-T port	18-1
-----------------	------

A

ACQUIRE menu	3-1
acquisition mode	3-1
ACTION Action on Trig menu	2-78
ACTION Go/Nogo menu	2-79
action-on-trigger	2-78
addition, subtraction, and multiplication	6-2
Address Data mode	2-62
A Delay B	2-75
ANALYSIS Histogram menu	13-1, 13-2
ANALYSIS Power Analysis menu	14-1
ANALYSIS Power Analysis menu (harmonics)	14-6
ANALYSIS Power Analysis menu (I2t)	14-9
ANALYSIS Power Analysis menu (SOA)	14-5
ANALYSIS Power Analysis menu (SW loss)	14-2
ANALYSIS Power Measurement menu	14-10
angle cursor	8-5
applicable class	14-7
area (XY)	5-2
A to B(n)	2-75
A trigger	2-76
auto naming	17-3
auto scrolling	10-2
auto setup (CAN bus)	12-6
auto setup (CAN FD bus)	12-11
auto setup (CXPI bus)	12-21
auto setup (FlexRay bus)	12-2
auto setup (I2C bus)	12-47
auto setup (LIN bus)	12-16
auto setup (PSI5)	12-33
Auto Setup (PSI5)	12-33
auto setup (SENT)	12-26
auto setup (SPI bus)	12-53
auto setup (UART)	12-40

B

bandwidth limit	1-4
bit and bus display order	1-12
bit settings	1-8
Break Synch mode	2-38
broadcasting system	2-73
B trigger	2-76
B TRIG menu	2-75
bus display	1-10
bus setup (CAN bus analysis and search)	12-6
bus setup (CAN FD bus analysis and search)	12-11
bus setup (CXPI bus analysis and search)	12-21
bus setup (FlexRay bus analysis and search)	12-2
bus setup (I2C bus analysis and search)	12-47
bus setup (LIN bus analysis and search)	12-16
bus setup (PSI5 analysis and search)	12-33
bus setup (SENT analysis and search)	12-26
bus setup (SPI bus analysis and search)	12-53
bus setup (UART analysis and search)	12-40

bus setup (user-defined bus analysis and search)	12-61
--	-------

C

cables	18-1
Calc Setup (power measurement)	14-12
Calc Setup (waveform parameter)	9-10
CAN FD bus analysis and search	12-10
CAN FD bus trigger	2-31
CAN FD standard	12-11
channels, loading to	17-10
chip select source (SPI bus analysis and search)	12-56
chip select source (SPI bus trigger)	2-69
CH menu	1-1
class setup (harmonic analysis)	14-7
clear trace	4-4
clock source	11-5
clock source (pattern trigger)	2-7
clock source (SPI bus analysis and search)	12-55
clock source (SPI bus trigger)	2-67
clock source (user-defined bus analysis and search)	12-62
clock source (user-defined bus trigger)	2-71
color	4-2
combination (B TRIG)	2-75
Combination (B TRIG)	2-75
computation conditions	6-13
computation mode	6-1
computation source waveform	6-2
Condition Setup (CAN bus trigger)	2-28, 2-29
Condition Setup (CAN FD bus trigger)	2-34
Condition Setup (CXPI bus trigger)	2-43, 2-44
Condition Setup (edge search)	11-2
Condition Setup (FlexRay bus trigger)	2-24, 2-25
Condition Setup (I2C bus trigger)	2-63, 2-65
Condition Setup (LIN bus trigger)	2-39, 2-40
Condition Setup (pattern search)	11-5
Condition Setup (PSI5 trigger)	2-56
Condition Setup (pulse width search)	11-9
Condition Setup (SENT trigger)	2-49, 2-50
Condition Setup (SPI bus trigger)	2-69
Condition Setup (timeout search)	11-12
Condition Setup (UART trigger)	2-59
Condition Setup (user-defined bus trigger)	2-71, 2-72
connection procedure (Ethernet)	18-2
continuous	9-5
count setting	6-6
count type	6-6
CS (SS) (SPI bus analysis and search)	12-56
CS (SS) (SPI bus trigger)	2-69
cursor jumping	8-1
CURSOR menu	8-1
cursor position, setting	8-1, 8-2, 8-3, 8-5
CXPI bus analysis and search	12-20
cycle	9-7
cycle mode	9-2, 14-11, 14-13
cyclic statistical processing	9-7

D

data compression	17-4
Data mode (PSI5 trigger)	2-56
Data mode (UART trigger)	2-59
data source (SPI bus analysis and search)	12-55
data source (SPI bus trigger)	2-68
data source (user-defined bus analysis and search)	12-61

Index

data source (user-defined bus trigger)	2-70
data to load	17-13
data to save	17-7
Decode (CAN bus)	12-7
Decode (CAN FD bus)	12-12
Decode (CXPI bus)	12-22
Decoded Display(CAN bus)	12-7
Decoded Display(CAN FD bus)	12-12
Decoded Display(CXPI bus)	12-22
Decoded Display(FlexRay bus)	12-3
Decoded Display(I2C bus)	12-49
Decoded Display(LIN bus)	12-17
Decoded Display(PSI5)	12-36
Decoded Display(SENT)	12-28
Decoded Display(SPI bus)	12-57
Decoded Display(UART)	12-42
Decoded Display(user-defined serial bus)	12-63
Decode (FlexRay bus)	12-3
Decode (I2C bus)	12-49
Decode (LIN bus)	12-17
Decode (PSI5)	12-36
Decode (SENT)	12-28
Decode (SPI bus)	12-57
Decode (UART)	12-42
Decode (user-defined serial bus)	12-63
delay	6-4
delay cancel	2-3
delay canceling	2-3
DELAY key	2-2
deskew (logic signal)	1-12
detected point mark	11-2
detected waveform display	11-2
difference between peak and valley	7-4
digital filter	6-14
display, filtering files	17-18
display format (file list)	17-17
DISPLAY menu	4-1, 4-3
display mode	15-1
display setup (edge search)	11-2
Display Setup (FFT)	7-2
display setup (PSI5)	12-37
display setup (SENT)	12-30
display size (logic signal)	1-13

E

Page

edge count	6-7
EDGE menu	2-4
edit	2-82
enable source (user-defined bus analysis and search)	12-62
enable source (user-defined bus trigger)	2-72
enable (user-defined bus analysis and search)	12-62
enable (user-defined bus trigger)	2-72
ENHANCED CAN FD menu	2-31
ENHANCED CAN menu	2-26
ENHANCED CXPI menu	2-41
ENHANCED Edge OR menu	2-6
ENHANCED FlexRay Menu	2-23
ENHANCED I2C menu	2-61
ENHANCED Interval menu	2-21
ENHANCED LIN menu	2-37
ENHANCED Pattern menu	2-7
ENHANCED_PSI5 Airbag Menu	2-53
ENHANCED Pulse Width menu	2-11
ENHANCED Rise/Fall Time menu	2-13
ENHANCED Runt menu	2-15
ENHANCED SENT menu	2-46
ENHANCED SPI menu	2-66
ENHANCED Timeout menu	2-17

ENHANCED TV menu	2-73
ENHANCED UART menu	2-57
ENHANCED User Define menu	2-70
ENHANCED Window menu	2-18
ENHANCED Window OR menu	2-20
equation	6-13
error mode (CAN bus trigger)	2-27
error mode (CAN FD bus trigger)	2-33
error mode (CXPI bus search)	12-24
error mode (CXPI bus trigger)	2-42
error mode (FlexRay bus trigger)	2-24
error mode (LIN bus trigger)	2-38
error mode (PSI5 trigger)	2-56
error mode (SENT trigger)	2-52
error mode (UART trigger)	2-59
ESI mode	2-36
Ethernet	18-1
Ethernet interface specifications	18-1
Every Data mode	2-59
Every Fast CH mode	2-47
Every Slow CH mode	2-49
Every Start mode	2-62
expression	6-13

F

Page

Fast CH Data mode	2-48
Fast CH S&C mode	2-48
FD mode	2-36
FD standard	12-11
FFT conditions	7-1
FFT Measure Setup menu	7-3
FFT menu	7-1
FFT results, saving	17-9
field jumping (CAN bus)	12-9
field jumping (CAN FD bus)	12-14
field jumping (FlexRay bus)	12-4
field jumping (LIN bus)	12-19
file filtering	17-18
file list	17-2, 17-15
file list, sorting	17-18
file name	17-3
File Others (Load) menu	17-13
File Others (Save) menu	17-7
files and folders, copying	17-20
files and folders, deleting	17-22
files and folders, moving	17-21
files and folders, renaming	17-22
file, selecting	17-16
File Setup (Load) menu	17-12
File Setup (Save) menu	17-6
File Utility menu	17-23
File Waveform (Load) menu	17-10
File Waveform (Save) menu	17-2
filtering (files to display)	17-18
filter settings	6-4
filter type	6-4
FlexRay bus analysis and search	12-1
FlexRay bus trigger	2-23
folders (directories), creating	17-19
FORCE TRIG	2-77
Frame in slot mode	2-55
Frame Start mode	2-24
FTP server	18-4

G

Page

general call	2-64
General Call mode	2-64
GO/NO-GO determination	2-79

gradation mode.....	4-3
graticule.....	4-1
grid.....	4-1
grouping.....	12-42

H

	Page
harmonic analysis.....	14-6
HDTV.....	2-74
high speed mode.....	2-65
histogram display (statistical processing).....	9-7
histogram, saving.....	17-9
history.....	9-9
HISTORY menu.....	15-1, 15-4
history range.....	17-4
history waveform, searching.....	15-4
Holdoff.....	2-1
hold-off time.....	2-1
horizontal expansion and reduction.....	1-14
HS Mode.....	2-65

I

	Page
I2C bus analysis and search.....	12-46
ID/Data mode (CAN bus trigger).....	2-27
ID/Data mode (CAN FD).....	2-33
ID/Data mode (CXPI bus trigger).....	2-43
ID/Data mode (FlexRay bus trigger).....	2-24
ID/Data mode (LIN bus trigger).....	2-38
ID OR mode (CAN bus trigger).....	2-29
ID OR mode (CAN FD bus trigger).....	2-35
ID OR mode (CXPI bus trigger).....	2-44
ID OR mode (FlexRay bus trigger).....	2-25
ID OR mode (LIN bus trigger).....	2-40
IIR filter.....	6-4
Include R/W.....	2-62, 12-48
information.....	16-3, 16-6, 17-8
initial computation point.....	6-5
initial point.....	6-5
input coupling.....	1-2
input range.....	2-5
intensity.....	4-3, 15-1
internal memory, details.....	17-6
ISO.....	2-33, 12-10
item (histogram).....	13-2
Item Setup (Area2).....	9-10
item setup (power measurement).....	14-11

J

	Page
Joule integral.....	14-9
judgment conditions.....	2-80

L

	Page
label display.....	1-4
label (Math/Ref).....	6-11
label/unit.....	6-9
Language.....	19-1
latch.....	12-63
latch source (user-defined bus analysis).....	12-63
latch source (user-defined bus trigger).....	2-72
latch (user-defined bus trigger).....	2-72
level setup.....	14-4
LIN bus analysis and search.....	12-15
linear scaling.....	1-4
list (CAN bus analysis).....	12-8
list (CAN FD bus analysis).....	12-13
list (CXPI bus analysis).....	12-23
list display (CAN bus analysis).....	12-8
list display (CAN FD bus analysis).....	12-13

list display (CXPI bus analysis).....	12-23
list display (file list).....	17-17
list display (FlexRay bus analysis).....	12-3
list display (I2C bus analysis).....	12-50
list display (LIN bus analysis).....	12-18
list display (multiple display).....	12-65
list display (PSI5 analysis).....	12-36
list display (SENT analysis).....	12-28
list display (SPI bus analysis).....	12-58
list display (statistical processing).....	9-8
list display (UART analysis).....	12-43
list (FlexRay bus analysis).....	12-3
list (harmonic analysis).....	14-8
list (history waveform).....	15-2
list (I2C bus analysis).....	12-50
list (LIN bus analysis).....	12-18
list (multiple display).....	12-65
list (peak cursor measurement).....	7-4
list (PSI5 analysis).....	12-36
list, saving.....	14-8
list (SENT analysis).....	12-28
list (SPI bus analysis).....	12-58
list (statistics of automatically measured values).....	9-8
list (UART analysis).....	12-43
LOGIC menu.....	1-7
loss, type of.....	14-3

M

	Page
mail.....	18-5
mail transmission settings.....	18-5
mapping.....	4-1
marker cursor.....	8-4
marker cursor measurement (FFT).....	7-3
marker (FFT).....	7-3
MATH/REF menu.....	6-1
measured values, character size.....	19-2
MEASURE Enhanced menu.....	9-10
measurement items (angle cursor).....	8-5
measurement items (FFT).....	7-3, 7-4
measurement items (histogram).....	13-2
measurement items (marker cursor).....	8-4
measurement items (power measurement).....	14-11
measurement items (switching loss).....	14-3
measurement items (waveform parameter).....	9-2
measurement items (XY waveform).....	5-2
measurement items (ΔT cursor).....	8-1
measurement items (ΔT & ΔV cursor).....	8-3
measurement items (ΔV cursor).....	8-2
measurement location indicator (power measurement).....	14-13
measurement location indicator (waveform parameter).....	9-4
measurement source window.....	9-4
measurement time period.....	9-4
MEASURE menu.....	9-1
Measure Setup (Joule integral).....	14-9
Measure Setup (switching loss).....	14-3
MEASURE Statistics menu.....	9-5
message language.....	19-1
mode (acquisition mode).....	3-1
mode (CAN bus trigger).....	2-27
mode (CAN FD bus trigger).....	2-33
mode (computation mode).....	6-1
mode (CXPI bus trigger).....	2-42
mode (FlexRay bus trigger).....	2-24
mode (Go/Nogo).....	2-80
mode (I2C bus trigger).....	2-62
mode (LIN bus trigger).....	2-38
MODE menu.....	2-1
mode (PSI5 trigger).....	2-55

Index

mode (SENT trigger)	2-47
mode (TV trigger)	2-73
mode (UART trigger)	2-59
Moving Avg	6-4

N

	Page
Net Drive	18-6
Net Print	18-7
network connection	18-1
network drive	18-6
next higher level folder, displaying	17-19
NON ACK mode	2-64
normal statistical processing	9-5
NTSC	2-73

O

	Page
offset cancel	1-5
operation details, selecting	17-16
operation menu	17-15
operation menu and file list, switching between	17-15
overview	19-3

P

	Page
PAL	2-73
parameter (FFT)	7-4
parameter (Go/Nogo)	2-84
parameter measurement (FFT)	7-4
pattern (Edge OR trigger)	2-6
pattern (pattern search)	11-6
pattern (pattern trigger)	2-8
pattern (Window OR trigger)	2-20
peak cursor measurement (FFT)	7-4
peak (FFT)	7-4
phase shift	6-4
polygonal zone	2-83
polygonal zone, loading	17-14
PolygonZone	2-83
POSITION knob (horizontal axis)	2-2
POSITION knob (vertical axis)	1-6, 1-13
power supply analysis, type of	14-1
PRINT BuiltIn menu	16-3
printer roll paper	16-1
PRINT File menu	16-6
PRINT Key	16-3, 16-4, 16-5, 16-7, 16-9
print mode (built-in printer)	16-3
print mode (network printer)	16-5
print mode (USB printer)	16-4
PRINT Multi menu	16-9
PRINT Network menu	16-5
PRINT USB menu	16-4
probe (analog signal)	1-4
probe (power measurement)	14-10
probe (power supply analysis)	14-3
probe setup (power measurement)	14-10
protection, turning on and off	17-23
PSI5 Airbag trigger	2-53
PSI5 analysis and search	12-32
PTYPE mode (CXPI bus trigger)	2-43

R

	Page
range (edge trigger)	2-5
rectangular zone	2-81
RectZone	2-81
reference level during automated measurement	9-4, 14-12
reference range type	2-80
reference range using waveform parameters	2-84
reference setting (angle cursor)	8-6

reference setup	8-6
reference time (interval trigger)	2-22
reference time (pattern search)	11-7
reference time (pattern trigger)	2-9
reference time (pulse width search)	11-10
reference time (pulse width trigger)	2-12
reference time (rise/fall time trigger)	2-14
reference time (runt trigger)	2-16
reference time (window trigger)	2-19
Reference Waveform Information Display (Information)	6-11
reference waveform, loading	6-10
reference waveform, loading into	17-10
Ref Levels (power measurement)	14-12
Ref Levels (waveform parameter)	9-4
replay	15-3
roll paper handling	16-1
roll paper, loading	16-2
rotary count	6-7
RUN/STOP key	3-3
R/W bit on/off	2-62, 12-48

S

	Page
safe operating area analysis	14-5
sampling mode	3-2
save destination	17-2
save mode	16-6
SCALE knob (vertical axis)	1-5, 1-13
scale value	7-2
scaling	6-9
SCL source	2-62, 12-48
screen capture, saving	17-8
SDA source	2-62, 12-48
SDTV (480/60p)	2-74
search (CAN bus)	12-9
search (CAN FD bus)	12-14
search conditions (edge)	11-2
search conditions (pattern)	11-5
search conditions (pulse width)	11-9
search conditions (timeout period)	11-12
search (CXPI bus)	12-23
SEARCH Edge menu	11-1
search (FlexRay bus)	12-4
search (history waveform)	15-4
search (I2C bus)	12-51
search (LIN bus)	12-19
search mode	9-9
SEARCH Pattern menu	11-4
search (PSI5)	12-38
SEARCH Pulse Width menu	11-8
search (SENT)	12-31
search, skipping	11-3
search source pattern	11-6
search (SPI bus)	12-59
SEARCH Timeout menu	11-11
search (UART)	12-45
search (user-defined bus)	12-64
search (waveform search)	11-3
select all or deselect all	17-16, 17-23
select or deselect	17-16, 17-23
SENT analysis and search	12-25
SENT trigger	2-46
serial bus analysis results, saving	17-9
SERIAL BUS CAN FD menu	12-10
SERIAL BUS CAN menu	12-5
SERIAL BUS CXPI menu	12-20
SERIAL BUS FlexRay menu	12-1
SERIAL BUS I2C menu	12-46
SERIAL BUS LIN menu	12-15

SERIAL BUS PSI5 Airbag menu	12-32	trigger level (window OR trigger)	2-20
SERIAL BUS SENT menu	12-25	trigger mode	2-1, 3-1
SERIAL BUS SPI menu	12-52	trigger mode (PSI5)	2-55
SERIAL BUS UART menu	12-39	trigger position	2-2
SERIAL BUS User Define menu	12-60	trigger source pattern (Edge OR trigger)	2-6
serial bus waveform symbols, loading	17-14	trigger source pattern (pattern trigger)	2-8
setting information	16-6, 17-7	trigger source pattern (window OR trigger)	2-20
settings when trigger level changes	9-5	trigger type (CAN bus)	2-27
SINGLE key	3-3	trigger type (CAN FD bus)	2-33
single mode	2-1, 3-3	trigger type (CXPI bus)	2-42
skip mode	11-3	trigger type (FlexRay bus)	2-24
Slow CH ID/Data mode	2-50	trigger type (I2C bus)	2-62
smoothing	6-4	trigger type (LIN bus)	2-38
SMTP client	18-5	trigger type (SENT)	2-47
snapshot waveforms, loading	17-14	trigger type (UART)	2-59
snapshot waveforms, saving	17-8		
SNTP	18-8	U	Page
SOA	14-5	UART analysis and search	12-39
SOF mode (CAN bus trigger)	2-27	UART trigger	2-57
SOF mode (CAN FD bus trigger)	2-33	unit	6-9, 7-1
SOF mode (CXPI bus trigger)	2-42	USB keyboard language	19-1
SPI bus analysis and search	12-52	USB storage device	19-4
Start bit mode	2-55	USB storage device, connection	17-1
start byte	2-65	user-defined serial bus analysis and search	12-60
Start Byte mode	2-65	Userdef TV	2-74
state display	1-11	UTILITY Network menu (FTP server)	18-4
statistical processing of history waveforms	9-9	UTILITY Network menu (mail)	18-5
statistics of automatically measured values	9-5	UTILITY Network menu (Net Drive)	18-6
switching loss analysis	14-2	UTILITY Network menu (Net Print)	18-7
symbol	12-7, 12-12	UTILITY Network menu (SNTP)	18-8
Sync mode	2-55	UTILITY Network Menu (TCP/IP)	18-3
		UTILITY Overview menu (setting information)	19-3
T	Page	UTILITY System Configuration menu (click sound)	19-2
thumbnail display	17-17	UTILITY System Configuration menu (Display)	4-5
time condition (interval trigger)	2-22	UTILITY System Configuration menu (language)	19-1
time condition (pattern search)	11-7	UTILITY System Configuration menu (measured value)	19-2
time condition (pattern trigger)	2-9	UTILITY System Configuration menu (offset cancel)	1-5
time condition (pulse width search)	11-9	UTILITY System Configuration menu (USB function)	19-4
time condition (pulse width trigger)	2-12		
time condition (rise/fall time trigger)	2-14	V	Page
time condition (runt trigger)	2-16	vertical position (analog signal)	1-6
time condition (window trigger)	2-19	vertical position (logic signal)	1-13
TIME/DIV knob (horizontal axis)	1-14	vertical scale	1-5
timeout period (timeout search)	11-11	vertical zoom	10-3
timeout period (trigger mode)	2-1		
timestamps, displaying the list of	15-2	W	Page
timestamps, saving the list of	17-9	wakeup/sleep mode (CXPI bus search)	12-24
total harmonic distortion	14-8	wakeup/sleep mode (CXPI bus trigger)	2-45
trend display	9-6	waveform acquisition	3-3
trend display (PSI5 analysis)	12-37	waveform assignment	4-1
trend display (SENT analysis)	12-29	waveform gradation (file)	16-7
trend/histogram	9-6	waveform gradation (network printer)	16-5
trend (PSI5 analysis)	12-37	waveform gradation (USB printer)	16-4
trend (SENT analysis)	12-29	waveform parameters, automated measurement of	9-1
trigger conditions (CAN bus)	2-28, 2-29	waveform search	11-1
trigger conditions (CAN FD bus)	2-34, 2-36	waveform zone	2-81
trigger conditions (CXPI bus)	2-43, 2-44	waveform zones, loading	17-14
trigger conditions (FlexRay bus)	2-24, 2-25	waveform zones, saving	17-8
trigger conditions (I2C bus)	2-63, 2-65	waveform zoom	10-1
trigger conditions (LIN bus)	2-39, 2-40	WaveZone	2-81
trigger conditions (PSI5)	2-56	what to operate, selecting	17-16
trigger conditions (SENT)	2-49, 2-50	window to save	17-4
trigger conditions (SPI bus)	2-69		
trigger conditions (UART)	2-59	X	Page
trigger conditions (user-defined bus)	2-71	XY Measure Setup menu	5-2
trigger delay	2-2	X-Y menu	5-1
trigger level (Edge OR trigger)	2-6		
trigger level (pattern trigger)	2-9		

Index

Z	Page
zoom factor.....	10-2
ZOOM knob.....	10-2
ZOOM menu.....	10-1
ZOOM Vertical Zoom menu.....	10-3