



BIPOLAR DC POWER SUPPLY

BP4640 / BP4650

Instruction Manual

DA00061329-003

BIPOLAR DC POWER SUPPLY

BP4640 / BP4650

Instruction Manual

— Preface —

Thank you for purchasing the BP4640/BP4650 bipolar DC power supply.

To ensure safe and proper use of this electric equipment, please read first INSTRUCTIONS FOR SAFE USE on the following pages.

■ Caution Symbols Used in This Manual

The following caution symbols are used in this manual. Be sure to observe these caution symbols and their contents to ensure the safety of the user and avoid damage to the equipment.

WARNING

This symbol indicates information for avoiding danger to human life or bodily injury while handling this product.

CAUTION

This symbol indicates information for preventing damage to the product when handling it.

● This manual has the following chapter organization.

If reading this manual for the first time, start from 1. OUTLINE.

1. OUTLINE

Describes various items that must be checked prior to using this product.

2. PREPARATIONS BEFORE USE

Describes various cautions regarding preparations to be made before using this product, ranging from installation to connection of the power supply.

3. NOMENCLATURE

Describes the names of the various parts of this product.

4. OPERATION

Describes how to use this product, from its basic operation to the use of advanced functions.

5. USB INTERFACE

Describes the commands for controlling this product via the USB interface.

6. TROUBLESHOOTING

Describes error messages and handlings when problems occur.

7. MAINTENANCE

Describes basic operation tests and daily maintenance procedures.

8. SPECIFICATIONS

Lists the specifications (functions and performance) of this product.

9. INITIAL SETTING LIST

Lists the initial settings.

● Scope of contents

The description of this manual applies to products with firmware version 3.00 and above. For details on checking the firmware version, see Chapter 7.4.

— Safety Precautions —

To ensure safe use, be sure to observe the following warnings and cautions.

NF Corporation shall not be held liable for damages that arise from a failure to observe these warnings and cautions.

This product is a Class 1 product (with protective conductor terminal) that conforms to the JIS and IEC insulation standards.

- **Be sure to observe the contents of this instruction manual.**

This instruction manual contains information for the safe operation and use of this product.

Be sure to read this information first before using this product.

All the warnings in the instruction manual must be heeded to prevent hazards that may cause major accidents.

- **Be sure to ground the product.**

Ensure to connect the protective conductor terminal of the power input terminal of this product to an earth ground so that ground resistance is 100 Ω or less. If the product is not certainly grounded, an electric shock might occur.

Because of large leakage current, to prevent electric shock, ensure that the protective grounding conductor is connected before you connect a cable to the power input terminals L1, L2, L3, and N.

For grounding, use an equivalent cable whose diameter is same or greater.

- **Check the power supply voltage.**

This product operates on the power supply voltage indicated in **Grounding and Power Supply Connection** in this instruction manual.

Prior to connecting the power supply, check that the voltage of the power supply matches the rated power supply of the product.

The power input voltage is noted as line voltage in three-phase four-wire input, unless otherwise noted.

- **In case of suspected anomaly**

If this product emits smoke, an abnormal smell, or abnormal noise, immediately power it off and stop using it.

If such an anomaly occurs, do not use this product until it has been repaired, and immediately report the problem to the location of purchase (either NF Corporation or your distributor).

- **Do not use this product when gas is present.**

An explosion or other such hazard may result.

- **Do not remove the cover.**

This product contains high-voltage parts. Absolutely never remove its cover.

Even when the inside of this product needs to be inspected, do not touch the inside. All such inspections are to be performed by service technicians designated by NF Corporation.

- **Do not modify this product.**

Absolutely never modify this product, as this may cause new hazards and may disqualify this product from repair in case of failure.

- **This product weights over 165 kg.**

Do not carry it alone, or you may suffer physical injury.

- **Do not expose this product to water.**

When this product is used in wet condition, it may cause an electric shock and a fire. If this product is exposed to water, cut the power at the distribution board immediately, and contact NF Corporation or one of our representatives.

- **If lightning occurs, power off this product and cut the power at the distribution board.**

A lightning may cause an electric shock, a fire and a failure.

- **Safety-related symbols**

The general definitions of the safety-related symbols used on this product and in the instruction manual are provided below.



- **Instruction Manual Reference Symbol**

This symbol is displayed to alert the user to potential danger and refer him/her to the instruction manual.



- **Electric Shock Danger Symbol**

This symbol indicates locations that present a risk of electric shock under specific conditions.



- **Protective Ground-Terminal Symbol**

This symbol identifies a pin that must be grounded to avoid electric shock. Before operating the device, be sure to safely connect the protective conductor terminal of the power input terminal of this product to an earth ground so that ground resistance is 100 Ω or less.



- **Warning Symbol**

This symbol indicates information for avoiding danger to human life or bodily injury while handling this product.



- **Caution Symbol**

This symbol indicates information for preventing damage to the product when handling it.

- **Other symbols**



This symbol indicates that the external conductor of the connector is connected to the case.

- **Waste disposal**

To help ensure environmental protection, please note the following precautions regarding disposal of this product.

<1> This product contains a lithium battery.

<2> Use a professional industrial waste contractor to dispose of this product.

- **Other considerations**

All the accessories, peripherals, and options of this product are exclusively for this product. These products are not to be installed nor used for any other purposes besides their intended usage.

To prevent electric shock and failure, absolutely never insert foreign objects or allow liquids inside this product.

To prevent electric shock and failure, make sure that the metal parts of connection cables are hidden.

Contents

	Page
1. OVERVIEW	1-1
1.1 General	1-2
1.2 Features	1-2
1.3 Principle of Operation	1-4
2. PREPARATIONS BEFORE USE	2-1
2.1 Before Using this product.....	2-2
2.2 Installation Environment.....	2-3
2.3 Grounding and Power Supply Connection.....	2-5
2.3.1 Grounding.....	2-5
2.3.2 Power supply.....	2-5
2.4 Connection to I/O terminals	2-7
2.4.1 Connection to power supply input terminals	2-7
2.4.2 Connection to output terminals	2-9
2.4.3 Connection to USB connector.....	2-11
2.4.4 Connection to external control I/O connector.....	2-12
2.4.5 Connection to external signal input pin	2-14
2.4.6 Connection to monitor output pin.....	2-15
2.5 Power on/off and Operation Check	2-16
2.6 Radio Law.....	2-17
3. NOMENCLATURE.....	3-1
3.1 Nomenclature	3-2
3.1.1 Operation panel.....	3-2
3.1.2 Front panel	3-4
3.1.3 Rear panel.....	3-6
3.2 Tilting LCD Screen.....	3-7
4. OPERATION.....	4-1
4.1 LCD Screen	4-3
4.1.1 Status icons.....	4-4
4.1.2 Warning and error display	4-5
4.1.3 Sequence display	4-5
4.2 Basic Operation	4-6
4.2.1 Menus	4-6
4.2.2 Menu tree navigation method.....	4-9
4.2.3 Numerical input operation.....	4-10
4.2.4 Numerical input operation requiring confirmation (during USB ID setting)	4-10
4.2.5 Selective input operation requiring confirmation	4-10
4.2.6 Execution input	4-11
4.2.7 Shortcut keys	4-11
4.3 Basic Functions	4-12
4.3.1 Setting of operation mode.....	4-13

Contents

4.3.2	Output on/off	4-15
4.3.3	Setting of DC voltage and DC current	4-17
4.3.4	Setting of superimposed AC voltage and superimposed AC current.....	4-18
4.3.5	Setting of frequency	4-21
4.3.6	Setting of waveform	4-22
4.4	Setting of limiters	4-24
4.4.1	Shifting the output voltage range	4-26
4.4.2	Output voltage limiters	4-28
4.4.3	Output current limiters	4-28
4.5	Sequence Operation	4-29
4.5.1	Sequence operation specifications	4-29
4.5.2	Setting of sequence	4-36
4.5.3	Sequence programming	4-38
4.5.4	Sequence operation control	4-43
4.5.5	Sequence memory clear	4-45
4.5.6	Sequence operation setting example	4-46
4.5.7	Sequence operation execution.....	4-50
4.6	Control via External Control I/O Connector	4-54
4.7	Memory Function	4-55
4.8	Remote Control.....	4-58
4.8.1	Switching USB interface	4-59
4.8.2	USB ID.....	4-60
4.8.2.1	USBTMC	4-60
4.8.2.2	USB 488	4-62
4.8.3	Switch to local mode	4-63
4.9	System Menu.....	4-66
4.9.1	Keylock	4-68
4.9.2	Beep sound	4-69
4.9.3	LCD contrast adjustment.....	4-70
4.9.4	Setting of LCD display color	4-71
4.9.5	Setting of frequency and time units.....	4-72
4.9.6	Setting of operation of output and response calibrator at power-on	4-73
4.9.7	Setting of external control input enable/disable	4-74
4.9.8	Reset function	4-75
4.9.9	System information.....	4-75
4.10	Response Calibration.....	4-76
4.10.1	Outline	4-76
4.10.2	Fixed characteristics	4-77
4.10.3	Adjustment characteristics	4-78
4.10.4	Adjustment example	4-81
4.11	External Signal Input.....	4-82
4.12	Voltage and Current Monitor.....	4-83
4.13	Measurement Function.....	4-84
5.	USB INTERFACE.....	5-1
5.1	Preparations Before Usage.....	5-2
5.2	Program Message List.....	5-3

Contents

5.3	Explanation of Each Program Message	5-9
5.3.1	Basic settings.....	5-9
5.3.2	Limiter.....	5-11
5.3.3	Sequence Related.....	5-12
5.3.4	Measurement related.....	5-16
5.3.5	Arbitrary waveform memory.....	5-16
5.3.6	Store/recall memory.....	5-17
5.3.7	Status reporting.....	5-18
5.3.8	Overlap commands.....	5-20
5.3.9	Other.....	5-21
5.4	Status Configuration	5-23
5.4.1	Status byte.....	5-23
5.4.2	Standard event statuses.....	5-24
5.4.3	Message queue.....	5-24
5.4.4	Operation statuses.....	5-25
5.4.5	Warning statuses.....	5-26
5.4.6	Overload statuses.....	5-27
5.5	Response to Interface Messages	5-28
5.6	Programming Cautions	5-28
6.	TROUBLESHOOTING	6-1
6.1	Error Messages	6-2
6.1.1	Error at power-on.....	6-2
6.1.2	Protective function related errors.....	6-3
6.1.3	Errors during operation.....	6-5
6.1.4	Warning display.....	6-6
6.2	Protective Functions	6-7
6.2.1	Overload.....	6-8
6.2.2	Over-limiter.....	6-8
6.3	When Suspecting a Fault	6-9
7.	MAINTENANCE	7-1
7.1	Introduction	7-2
7.2	Daily Maintenance	7-2
7.3	Storage, Repacking, and Transportation	7-3
7.4	Version Number Verification Method	7-4
7.5	Cleaning the Air Filters	7-6
7.6	Backup Battery	7-7
7.7	Operation Inspection	7-8
7.8	Performance Test	7-10
8.	SPECIFICATIONS	8-1
8.1	Specification Conditions	8-2
8.2	Output	8-3
8.3	Output Limiters	8-5
8.4	Signal Sources	8-6
8.4.1	Internal signal source.....	8-6

Contents

8.4.2	External signal input.....	8-7
8.5	Monitor Output.....	8-8
8.6	Measurement Functions.....	8-9
8.7	Sequence Function.....	8-10
8.8	Arbitrary Waveform Memory.....	8-10
8.9	Setting Memory.....	8-11
8.10	Protective Functions	8-11
8.11	General	8-11
8.12	External Control I/O	8-12
8.13	USB Interface	8-12
8.14	Power Input	8-13
8.15	Withstand Voltage, Insulation Resistance.....	8-13
8.16	Ambient Temperature Range and Ambient Humidity Range	8-13
8.17	External Dimensions and Weight	8-14
8.18	EMC.....	8-14
8.19	Option	8-15
8.20	Output Voltage and Output Current Supply Ranges.....	8-15
8.21	Drawing of External Dimensions.....	8-20
9.	INITIAL SETTING LIST	9-1
9.1	Initial Setting List.....	9-2

Figures

	Page
Figure 1-1. Block Diagram.....	1-4
Figure 2-1. Ambient Temperature and Ambient Humidity Ranges	2-3
Figure 2-2. How to Use the Adjuster Foot	2-4
Figure 2-3. Power Supply Input Terminals	2-7
Figure 2-4. Output Terminals	2-9
Figure 2-5. Connection to Grounded Load or Measuring Instrument	2-10
Figure 2-6. USB Connector	2-11
Figure 2-7. External Control I/O Connector.....	2-12
Figure 2-8. EXT SIGNAL IN Terminal	2-14
Figure 2-9. MONITOR OUT Terminal	2-15
Figure 3-1. Lift Operation Panel.....	3-7
Figure 3-2. Operation Panel Lifting Method	3-7
Figure 3-3. Operation Panel Return Method	3-8
Figure 4-1. LCD Screen (Normal Display)	4-3
Figure 4-2. LCD Screen (Warning Display).....	4-3
Figure 4-3. Menu Tree	4-6
Figure 4-4. Modify Box	4-10
Figure 4-5. Select Box	4-10
Figure 4-6. Exe Box	4-11
Figure 4-7. LCD Screen	4-12
Figure 4-8. Block Diagram of Signal Source Block	4-14
Figure 4-9. Frequency Characteristics for Resistance Load in CV and CC Modes	4-20
Figure 4-10. DC Output Range (When Positive/Negative Voltage Limiter Setting Difference Is Fixed to 124 V).....	4-26
Figure 4-11. DC Output Range (When Negative Voltage Limiter Setting Is Fixed to -7 V).....	4-27
Figure 4-12. Basic Step Transition Example	4-31
Figure 4-13. Sequence Status Transition Block Diagram.....	4-32
Figure 4-14. Example of Sequence Operation When <Start> Is Executed from Hold Status	4-33
Figure 4-15. Example of Sequence Operation During <Branch>	4-33
Figure 4-16. Loop Specification Method and Step Transition Example	4-34
Figure 4-17. Step Sync Output Example	4-35
Figure 4-18. Sequence Operation upon Phase 0 deg Wait Occurrence	4-35
Figure 4-19. Sequence Shortcut Keys	4-44
Figure 4-20. Sequence Transition Example (in CV-INT Mode)	4-46
Figure 4-21. LCD Screen When Sequence Is Running	4-53
Figure 4-22. Memory Contents Display Example.....	4-55
Figure 4-23. EXT SIGNAL IN Terminal	4-82
Figure 4-24. MONITOR OUT Terminal	4-83

Figures

Figure 4-25. Measurement Value Display Example.....	4-84
Figure 6-1. Protective Function Related Error Display Examples	6-4
Figure 6-2. Examples of Error Display During Operation	6-5
Figure 6-3. Warning Display Example	6-6
Figure 7-1. SYSTEM INFORMATION Screen.....	7-5
Figure 7-2. Air Filter Cleaning Procedure	7-6
Figure 8-1. Ambient Temperature and Humidity Ranges	8-14
Figure 8-2. DC Output Range (When Positive/Negative Voltage Limiter Setting Difference Is Fixed to 124 V)	8-16
Figure 8-3. DC Output Range (When Positive/Negative Voltage Limiter Settings Are Symmetric)	8-16
Figure 8-4. DC Output Range (When Negative Voltage Limiter Setting Is Fixed to -7 V).....	8-17
Figure 8-5. DC Output Voltage (When Positive Voltage Limiter Setting Is Fixed to +7 V).....	8-17
Figure 8-6. AC Output Range (When Positive/Negative Voltage Limiter Setting Difference Is Fixed to 124 V)	8-18
Figure 8-7. AC Output Range (When Positive/Negative Voltage Limiter Settings Are Symmetrical)	8-18
Figure 8-8. AC Output Range (When Negative Voltage Limiter Setting Is Fixed to -7 V).....	8-19
Figure 8-9. AC Output Range (When Positive Voltage Limiter Setting Is Fixed to +7 V).....	8-19
Figure 8-10. Drawing of External Dimension	8-20

Tables

	Page
Table 2-1. Configuration List.....	2-2
Table 2-2. Maximum power and current consumption	2-5
Table 2-3. External Control I/O Connector Pin List.....	2-13
Table 4-1. Status Icon List.....	4-4
Table 4-2. Sequence Display	4-5
Table 4-3. SET Menu Item List.....	4-7
Table 4-4. MISC Menu Item List.....	4-7
Table 4-5. SEQUENCE Menu Item List.....	4-8
Table 4-6. MEMORY Menu Item List.....	4-8
Table 4-7. REMOTE Menu Item List.....	4-9
Table 4-8. SYSTEM Menu Item List	4-9
Table 4-9. Shortcut Key List.....	4-11
Table 4-10. Operation Mode List	4-13
Table 4-11. Superimposed AC Voltage Waveform and Superimposed AC Current Waveform List ...	4-22
Table 4-12. Limiter Setting Ranges.....	4-24
Table 4-13. Step Execution Parameters.....	4-30
Table 4-14. Step Transition Parameters.....	4-31
Table 4-15. Sequence Statuses	4-32
Table 4-16. Sequence Control	4-33
Table 4-17. PROGRAM Screen Item List.....	4-39
Table 4-18. CONTROL Select Box Item List	4-43
Table 4-19. PROGRAM Setting List.....	4-46
Table 4-20. Functions of External Control I/O Connector	4-54
Table 4-21. MEMORY Screen Menu Item List	4-55
Table 4-22. Operation Mode List	4-58
Table 4-23. System Menu Item List	4-66
Table 5-1. Basic Settings.....	5-4
Table 5-2. Limiters	5-4
Table 5-3. Sequence Related.....	5-5
Table 5-4. Measurement Related	5-6
Table 5-5. Arbitrary Waveform Memory	5-7
Table 5-6. Memory.....	5-7
Table 5-7. Status Reporting.....	5-7
Table 5-8. Overlap Command	5-8
Table 5-9. Other.....	5-8
Table 5-10. DC Current And Superimposed AC Current Setting Ranges	5-13
Table 5-11. Interface Messages	5-28
Table 6-1. Self-Diagnosis Errors	6-2

Tables

Table 6-2. Protective Function Related Errors	6-3
Table 6-3. Errors during Operation	6-5
Table 6-4. Warning Display	6-6
Table 6-5. Protective Functions	6-7
Table 9-1. Setting Memory	9-2
Table 9-2. Store/Recall Memory (All Memories)	9-3
Table 9-3. Arbitrary Waveform Memory	9-3
Table 9-4. Sequence Memory (All Steps).....	9-4

1.OVERVIEW

- 1.1 General 1-2
- 1.2 Features 1-2
- 1.3 Principle of Operation 1-4

1.1 General

The BP4640/BP4650 is a bipolar power supply that combines a high-speed power amplifier capable of bipolar output of an output voltage and current, and an internal signal source (DC and AC). It can be used as a high-speed bipolar amplifier that uses an external signal as input.

Since this product performs bipolar output, the output voltage and current supply ranges cover all four quadrants. Whereas only positive current (source current) can be supplied in the case of a general DC power supply, this product is capable of supplying both positive and negative (source and sink) current. Both CV and CC output characteristics are supported, and the rated output voltage and current are ± 60 V and ± 40 A to ± 50 A, respectively. The output voltage expansion function allows the output of a voltage of up to 120 Vp-p max. in the range of -115 V to $+115$ V.

This product has a response calibration function that allows the user to adjust the response characteristics of the amplifier according to the actual load that is used. As a result, output waveform distortion can be improved for a wide range of load conditions, including resistance load, capacitive load and inductive load. Using this function, it is also possible to raise the frequency band for the resistance load.

The functions (except response calibration adjustment) of this product can be remotely controlled from an external computer via the USB interface.

The consumption current can be minimized by using the input power factor control function.

1.2 Features

■ CV/CC output characteristics

The output characteristics can be selected from between CV (constant voltage) and CC (constant current).

CV characteristics: The voltage is supplied to the load proportionally to the input signal.

CC characteristics: The current is supplied to the load proportionally to the input signal.

■ Various signal sources

When using an internal signal source, it is possible to output the AC component (sine wave, square wave, arbitrary wave) on top of the DC component.

When using an external signal input, it is possible to add the external signal and internal signal sources.

■ Power input

Either three-phase three-wire input (3P3W) or three-phase four-wire input (3P4W) can be chosen when ordering.

■ Sequence function

When using an internal signal source, the output parameters (output voltage, current, output frequency) can be sequentially changed or swept, and by programming output changes beforehand, outputs with specific patterns can be supplied.

■ $\pm V_o$ limiter, $\pm I_o$ limiter function

The maximum values of the output voltage (V_o) and output current (I_o) can be independently set for each polarity. The output voltage and current are limited to these values.

■ Output voltage range expansion function

The output voltage amplitude range can be set to symmetric or asymmetric with regard to the polarity. Using the $\pm V_o$ limiter function, the output voltage range can be set to a maximum of 120 Vp-p including 0 V within the range of -115 V to $+115$ V. For example, the output voltage range can be set to the ranges of -60 V to $+60$ V, -5 V to $+115$ V, or -115 V to $+5$ V. Since the supplyable output current range changes according to the output voltage range setting, the optimum setting range can be selected from the required voltage and current.

■ Response calibration function

The amplifier response characteristics can be selected between fixed characteristics and user adjusted characteristics. Fixed characteristics are characteristics that emphasize both broad frequency band characteristics and load stability (during CV, DC to 35 kHz, -3 dB, during CC, DC to 8 kHz, -3 dB). In the case of user adjusted characteristics, the response characteristics actually adjusted by the user according to the load conditions can be used. Adjustments of the output voltage and current waveform are performed by moving three adjustment knobs for the time constant, voltage feedback amount, and current feedback amount, while watching an oscilloscope.

■ Output voltage and output current signal monitor output

The monitor ratio for the voltage is 1/100th of the output voltage, and the monitor ratio for the current is different for models, both in phase.

■ Measuring function

This function is used to measure and display the output voltage and current (DC value and P-P value for each).

■ Output on/off function

During output on/off switching, the output level (output voltage during CV, output current during CC) is lowered to 0 and then output relay opening/closing is performed to minimize contact arc.

■ USB interface provided as standard

External control can be performed from a PC, etc., via the USB interface.

■ PFC (Power Factor Control) function

The consumption current can be minimized with the PFC (input power factor control) function.

1.3 Principle of Operation

Figure 1-1 shows a block diagram of this product.

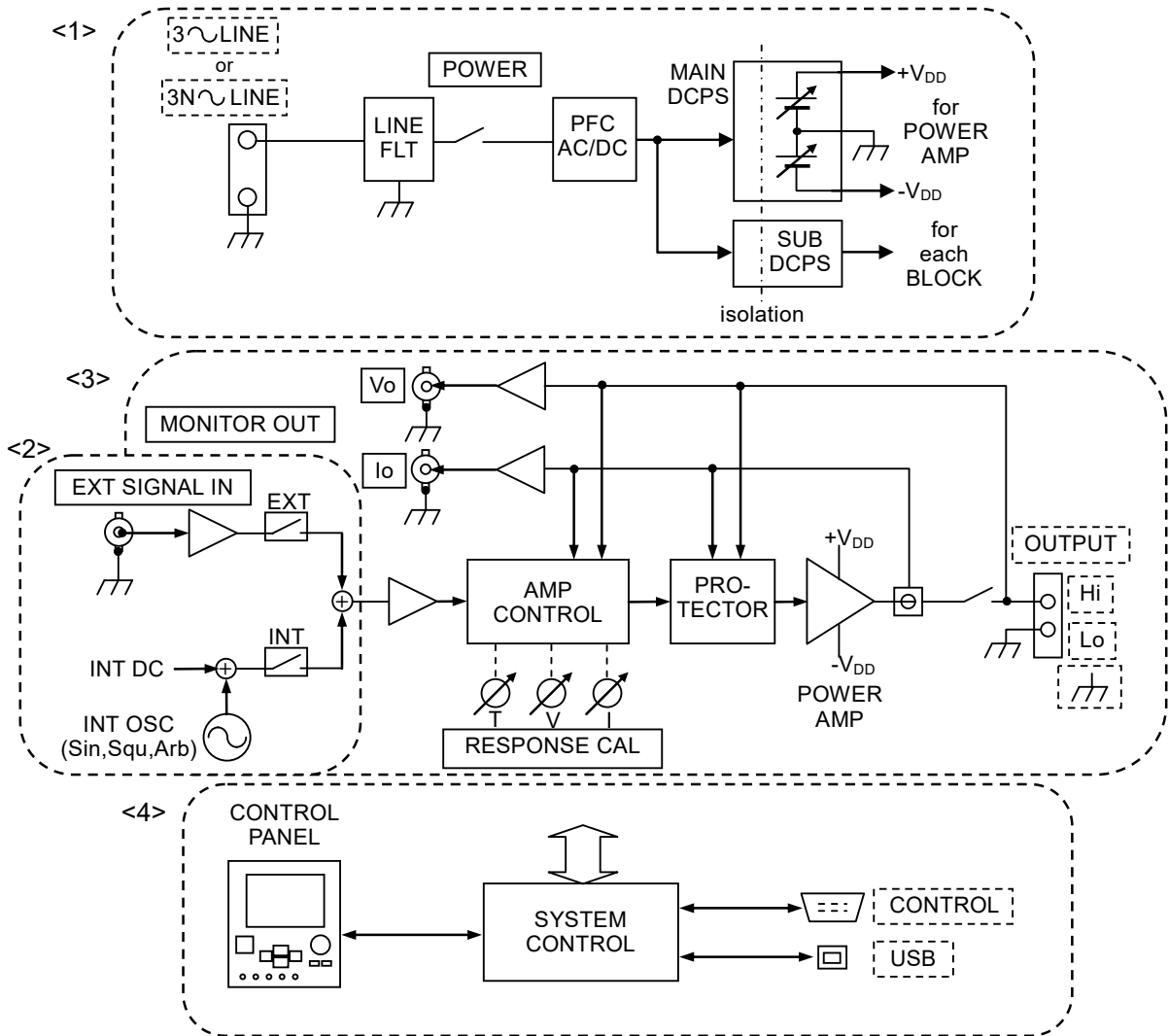

Figure 1-1. Block Diagram

1.3 Principle of Operation

This product is composed of the four major blocks.

<1> DC power supply block

The DC power supply block has a variable DC voltage function that works in conjunction with the power factor improvement function and voltage limiter value. Various control power supplies and positive/negative DC power supplies for the amplifier block can be created while improving the power factor for the power supply input. The output voltage range shift function is enabled by the variable DC voltage function. (Refer to “4.4.1 Shifting the output voltage range”.)

<2> Signal sources

This is an internal signal source that enables the sequence function and DC+AC output. An external input and internal signal can be used added together.

<3> Amplifier block

The amplifier block has a response calibration function and a protection circuit function. It outputs signals from an internal signal source or external signal source after amplifying them. Two types can be selected from among response characteristics, fixed characteristics, and user adjusted characteristics (response calibration function). If user adjusted characteristics is selected, the response characteristics can be adjusted according to the load conditions. (Refer to “4.10 Response Calibration”.)

<4> System control block

This block is in charge of the user interface, etc.

2. PREPARATIONS BEFORE USE

2.1	Before Using this product	2-2
2.2	Installation Environment	2-3
2.3	Grounding and Power Supply Connection	2-5
2.3.1	Grounding	2-5
2.3.2	Power supply	2-5
2.4	Connection to I/O terminals	2-7
2.4.1	Connection to power supply input terminals	2-7
2.4.2	Connection to output terminals	2-9
2.4.3	Connection to USB connector	2-11
2.4.4	Connection to external control I/O connector	2-12
2.4.5	Connection to external signal input pin	2-14
2.4.6	Connection to monitor output pin	2-15
2.5	Power on/off and Operation Check	2-16
2.6	Radio Law	2-17

2.1 Before Using this product

Before setting up and using this product, make sure that it has not suffered damage during transportation and that all the accessories and the main unit are included. If anything is missing, contact the NF distributor from which the product was purchased.

■ Safety check

Before using this product, read the INSTRUCTIONS FOR SAFE USE at the beginning of this instruction manual and perform a safety check.

Also, before connecting this product to a power supply, read 2.2 Installation Environment and thoroughly ensure that the installation environment is safe.

■ Appearance and accessories check

First, check that this product has not been damaged during transportation. Before installing this product, check the product configuration, which is listed in Table 2-1 Configuration List.

Table 2-1. Configuration List

Item	Q'ty
Main unit	1
Instruction Manual (this document)	1
CD-ROM Contents: Control Software for BP Series, LabVIEW Driver, Control Software for BP Series Instruction Manual	1
Ferrite core (for USB cable)	1

When repacking the product for shipping, place it in a box of sufficient strength and size to safely accommodate the weight and size of the product, making sure that the product is well protected.

WARNING

- This product contains high-voltage parts. Absolutely never remove its cover.
- All internal inspections of this product are to be performed only by service technicians well trained in hazard control.

2.2 Installation Environment

Observe the following points to ensure safe use of this product and maintain its reliability.

- To prevent this product from falling over, set it on a floor that is flat, free of vibrations, and sufficiently strong to withstand the weight of this product (97 kg per unit).
- Make sure that the ambient temperature and ambient humidity fall within the ranges indicated in the table below.

Performance Guarantee	+5 to +35 °C	5 to 85 %RH Absolute humidity of 1 to 25 g/m ³ , with no condensation.
Storage Conditions	-10 to +50 °C	5 to 95 %RH Absolute humidity of 1 to 29 g/m ³ , with no condensation.

Setting this product in a location with remarkably high humidity will lower its reliability. Use in an environment with 25 °C and 50 %RH is recommended.

Figure 2-1 shows the ambient temperature and the ambient humidity ranges.

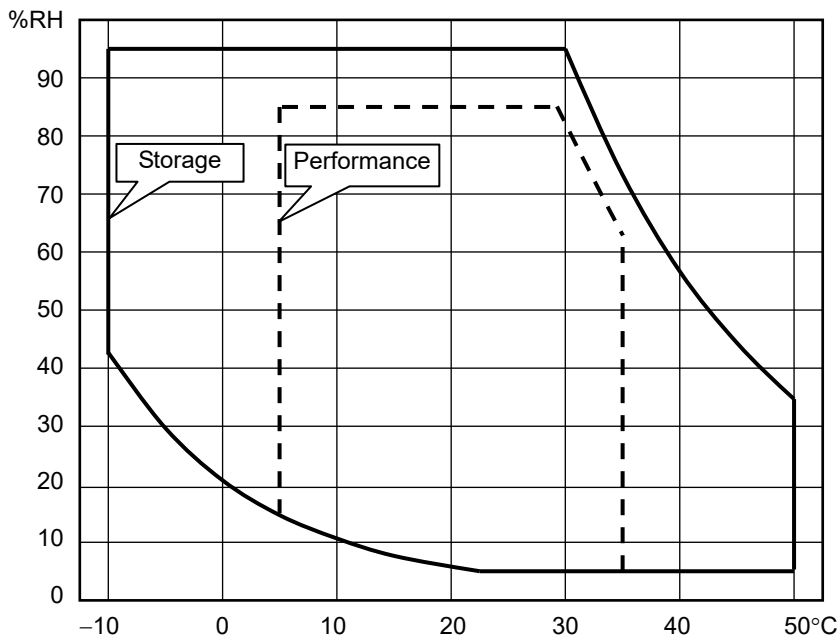

Figure 2-1. Ambient Temperature and Ambient Humidity Ranges

- Use the product indoors, at altitude up to 2000 m.
- Do not use this product in an environment that includes strong radio frequency electromagnetic fields (EMFs), because output current gauge indications may become temporarily incorrect or output may be cut off due to an incorrect overload reading.
- Place this product so that its air intake (front) and air exhaust (rear) vents are at a distance of 50 cm or more from the nearest walls to ensure that the air circulation is not impeded and that forced air cooling of the product functions fully.

2.2 Installation Environment

- Absolutely never place this product in the following locations.
 - Outdoors
 - Location exposed to direct sunlight
 - Narrow location with poor air circulation
 - High humidity location where condensation occurs easily
 - Location with a large amount of dust
 - Location with corrosive, explosive, or flammable gas
 - Location where the product may be exposed to flames or water
- This product may cause interference if used in residential areas. Such use must be avoided unless the user takes special measures to reduce electromagnetic emissions to prevent interference to the reception of radio and television broadcasts.
- The operation panel of this product includes a liquid crystal display. Be careful not to damage this display with a sharp or high-temperature object.

If the panel or case of this product becomes dirty, wipe it with a soft cloth. If the case of resistant stain, use a cloth that has been moistened with a neutral detergent and then thoroughly wrung.

Wiping this product using an organic solvent such as thinner or benzene or a pre-moistened wipe may cause degradation in material quality, clouding, or flaking off of the paint, and must therefore be avoided.
- Cautions when carrying this product

This product is heavy. Attempting to carry it by oneself may cause back injury and other types of injuries.
- Casters are provided for manually moving this product unit on a flat surface. Keep the speed when moving at walking speed or slower to prevent heat generation.

To prevent shock or vibration from being applied to the casters, do not drop the unit or use it on a surface that is uneven or has projections, and avoid bumping over, for example, the gap between the floor and an elevator.

Promptly replace damaged casters.
- Do not install this product on a sloped surface. The Adjuster Foot is only for temporary fixing, and cannot support the unit's own weight. You also must not lean on this product or use it as a support. How to use the Adjuster Foot is shown in Figure 2-2.

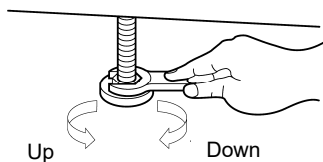

The Adjuster Foot can be moved up by turning it to left (counterclockwise) as viewed from above, and moved down by turning it to right (clockwise). Move the Adjuster Foot down by using an open-end wrench (24 mm width).

Figure 2-2. How to Use the Adjuster Foot

- Do not mount the unit or put any weight on it, such as by putting an object on it.

CAUTION

- If this product is exposed to sudden shifts in ambient temperature and/or humidity during transportation in the winter, internal condensation may occur. In such a case, allow the condensation to clear before connecting this product to a power supply.
-

2.3 Grounding and Power Supply Connection

2.3.1 Grounding

⚠ WARNING

- Ensure to connect the protective conductor terminal of the power input terminal of this product to an earth ground so that ground resistance is 100Ω or less. If the product is not certainly grounded, an electric shock might occur.
- Because of large leakage current, to prevent electric shock, ensure that the protective grounding conductor is connected before you connect a cable to the power input terminals L1, L2, L3, and N.
- For grounding, use an equivalent cable whose diameter is same or greater.

2.3.2 Power supply

⚠ CAUTION

- Before connecting this product to a power supply, make sure that the voltage of the power supply to which the unit is connected complies with the rated power supply voltage of this product.

- The power supply conditions of this product are as follows.
 - Voltage: Power input: three-phase three-wire input (3P3W)
200 V to 230 V ±10 %, with limited to 250 V or lower
 - Power input: three-phase four-wire input (3P4W)
380 V (phase voltage 220 V) ±15 %, with limited to 433 V (phase voltage: 250 V) or lower
 - Frequency: 50 Hz/60 Hz ±2 Hz
- Select a cable which has an appropriate diameter in consideration of the safety standards and consumption current. The current of each phase is unbalanced. Use a protective grounding conductor of which diameter is the same or greater than the power input cable.

Table 2-2. Maximum power and current consumption

Model	Maximum power consumption	Maximum current consumption	
		Power input 3P3W	Power input 3P4W
BP4640	4.8 kVA	19 A	15 A
BP4650	6 kVA	24 A	15 A

- Be careful when fastening with screws and when routing cords to prevent the power supply cord from becoming disconnected or loose.

2.3 Grounding and Power Supply Connection

WARNING

- This product contains high-voltage parts. Absolutely never remove its cover.
 - All internal inspections of this product are to be performed only by service technicians well trained in hazard control.
-

2.4 Connection to I/O terminals

2.4.1 Connection to power supply input terminals

Connect the cable from the distribution board to the power supply input terminals on the rear panel.

For safety, be sure to turn off the circuit breaker switch on the power panel before laying cables.

L1, L2, L3, N, and \perp are shown next to the power input terminals of this product. (If the three-phase three-wire input is chosen, this product does not have the N terminal.) Connect \perp to the protective grounding.

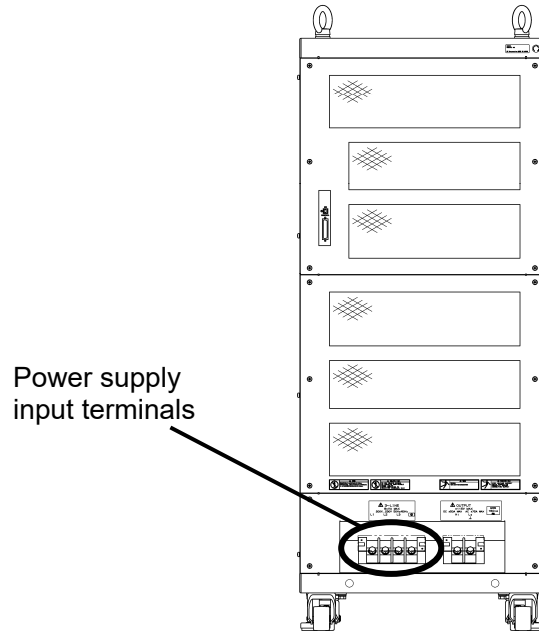

Figure 2-3. Power Supply Input Terminals

WARNING

- The power supply for this product must be taken from the distribution board.
- Be sure to switch off the breaker or the switch at the distribution board before connecting this product to the distribution board. Otherwise, an electric shock might occur.
- Route the wire so that the distance between this product and the distribution board breaker or switch is 3 m or less. If the distance with the distribution board exceeds 3 m, install another breaker or switch within 3 m from this product to connect. Use a breaker complying with IEC 60947-2 or a switch complying with IEC 60947-3 which can disconnect all L1, L2, L3, and N (Protective grounding must not be disconnected). Mark the breaker or the switch with a sign indicating that it is a disconnecting device of power input for this product.

It is requirements according to IEC 61010-1.

2.4 Connection to I/O terminals

■ Power source connection procedure

Check the current capacity of the distribution board before wiring. The wiring must be performed by a professional engineer.

1. Remove the resin-molded power input terminal cover and the power input cable holder.
2. Connect the power input cable to the power input terminal of this product. Be sure to tighten the screws firmly.
3. Attach the resin-molded power input terminal cover and the power input cable holder. Direct the folded part of the resin-molded power input terminal cover to the upper side of the product.
4. Ensure that the power switch of this product is turned off, and then connect the power input cable to the distribution board.

⚠ CAUTION

- Be sure to check phases L1, L2, L3, and N are correctly connected between this product and the distribution board.
- If this product whose power input is three-phase four-wire input (3P4W) is used without connecting N, it may be damaged. Be sure to connect all power cables.

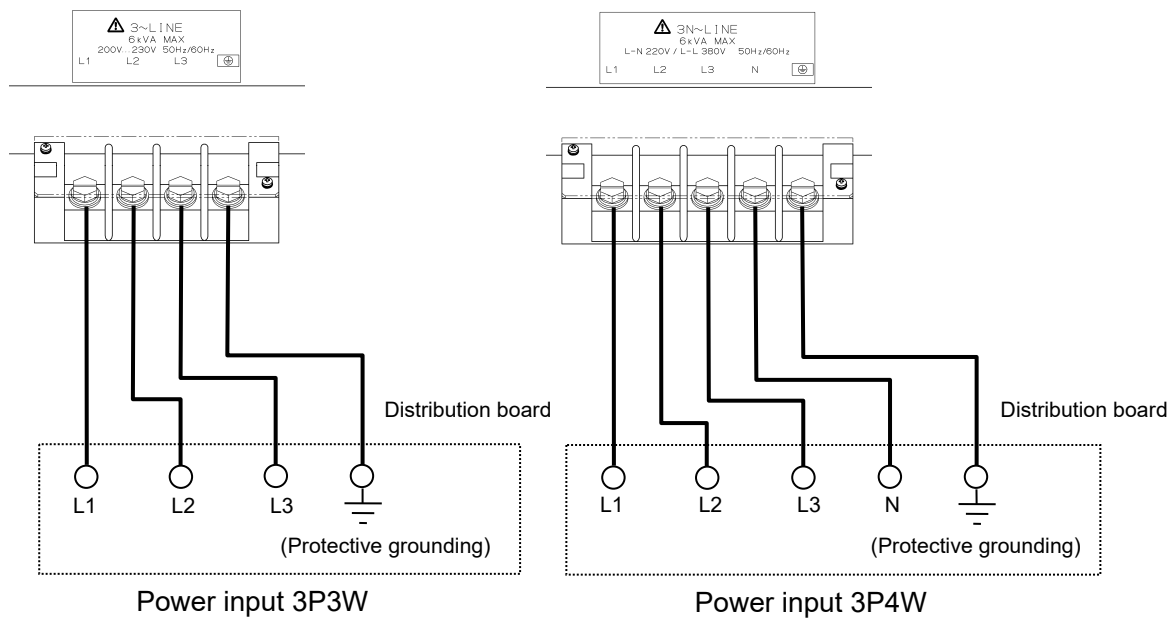

⚠ WARNING

- Do not use this product when the resin-molded terminal cover is removed. Otherwise, an electric shock might occur.

2.4.2 Connection to output terminals

The outputs are insulated between the power supply inputs. The “Lo” output terminal is connected to the chassis.

For the connection to the output terminals, use a cable that is resistant to a maximum output current, and a round crimp terminal with a sleeve.

For the wiring to the load, use a wire that is as thick as possible, twisting the wire together so that it does not form a loop, and not making it any longer than necessary.

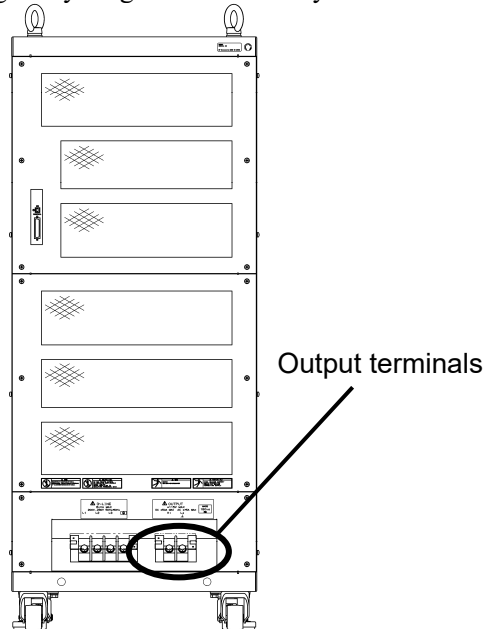

Figure 2-4. Output Terminals

CAUTION

- Note that since the “Lo” output terminal of this product is connected to the chassis, it is not possible to connect multiple outputs of this product in series.
- Also, do not connect a grounded load or measuring instrument whose input block is grounded to the output terminal of this product, as this may cause some of the output current to leak to the protective grounding wire of the power supply and have an unpredictable effect on the load or measuring instrument as shown in Figure 2-5.

WARNING

- During output, absolutely never touch the output terminals.
 - For safety’s sake, be sure to use this product with the supplied pin covers mounted.
 - To reduce the risk of electric shock and the contact between the terminals, use a round crimp terminal with a sleeve for the connection to the output terminals.
-

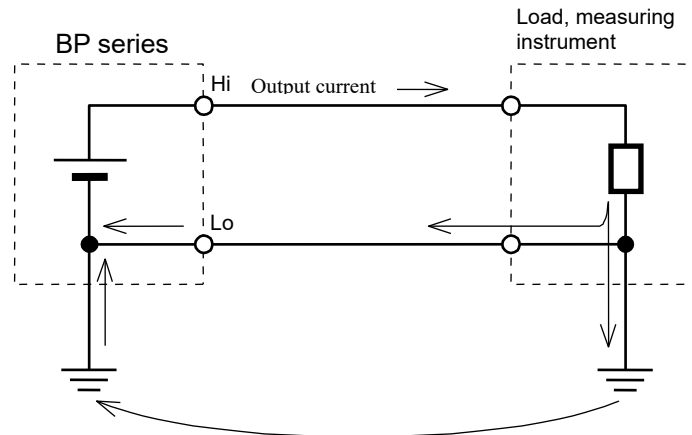

Figure 2-5. Connection to Grounded Load or Measuring Instrument

■ The procedure for connecting the cables to the output terminals is described below.

- <1> Remove the screw attached to the output terminal.
- <2> Insert the removed screw to the round crimp terminal attached to the cable.
- <3> Insert this to the OUTPUT pin while making sure that the cable does not come off the screw.
- <4> Securely tighten the screw until the terminal is fixed, using a torque of 6.6 (N·m).
- <5> After connecting both the “Hi” and “Lo” output terminals, attach the supplied terminal covers.

WARNING

- For safety's sake, be sure to connect the outputs after switching the power off.

2.4.3 Connection to USB connector

Using a commercially available USB cable, connect the USB connector on the rear panel to a PC. To reduce radiowave leakage, attach the accompanying ferrite core to the USB cable. For details on control from an external PC via USB, refer to “5. USB INTERFACE”.

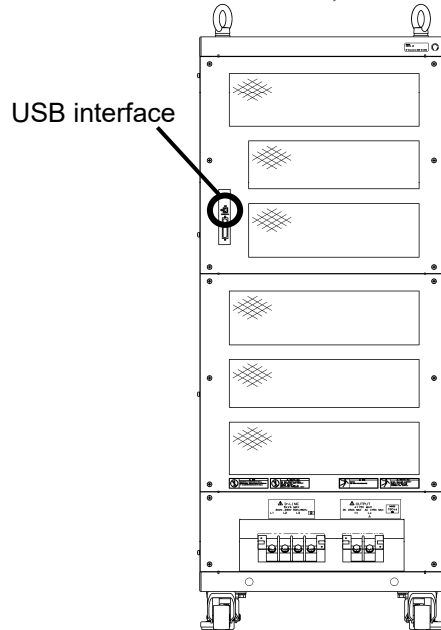

Figure 2-6. USB Connector

----- Comment -----

- As the USB cable, use a commercially available Type A-Type B cable.
- It is recommended to use fully-shield, short USB cable.
- The use of USB hub may cause a communication failure.
- To reduce radio leakage in the USB cable, attach the accompanying ferrite core.

2.4.4 Connection to external control I/O connector

This product has an external digital I/O (8 bits each for input and output) for control from external via digital signal input and status output via digital signals. The connector is a D-sub 25-pin connector.

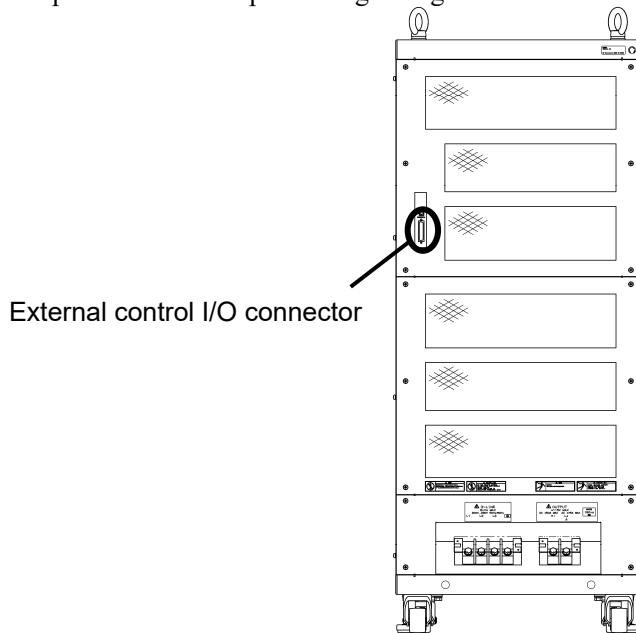

Figure 2-7. External Control I/O Connector

About external control,

 Refer to “4.6 Control via External Control I/O Connector”.

About enabling external control,

 Refer to “4.9.7 Setting of external control input enable/disable”.

2.4 Connection to I/O terminals

Table 2-2 lists the various pin signals.

Table 2-3. External Control I/O Connector Pin List

Pin No.	I/O	Function	Remark
1	Output	Power on/off status	0: Off 1: On
2	Output	Output on/off status	0: Off 1: On
3	Output	Overload	0: Normal 1: Overload
4	Output	Software busy	0: Normal 1: Busy
5	Output	Step sync output 0	
6	Output	Step sync output 1	
7	Output	Undefined	
8	Output	Undefined	
9	GND	–	
10	Input	Undefined	
11	Input	Output off	Falling detection
12	Input	Output on	Falling detection
13	Input	Sequence start	Falling detection
14	Input	Sequence stop	Falling detection
15	Input	Sequence hold	Falling detection
16	Input	Sequence branch trigger 0	Falling detection
17	Input	Sequence branch trigger 1	Falling detection
18	GND	–	
19	+5 V	–	50 mA or lower
20	Output	Reserved	
21	Output	Reserved	
22	Output	Reserved	
23	Output	Reserved	
24	Output	Reserved	
25	Output	Reserved	

2.4.5 Connection to external signal input pin

To use signal input from external as the signal source, connect the external signal input terminal (EXT SIGNAL IN) on the front panel to the external signal source. For the connection, use a coaxial cable with a BNC connector.

The specifications of the external signal input terminal are as follows.

Frequency range:	DC to 200 kHz
Gain:	100 × (100 V/1 V), in-phase (All models, CV mode) 40 × (40 A/1 V), in-phase (BP4640, CC mode) 50 × (50 A/1 V), in-phase (BP4650, CC mode)
Gain accuracy:	±5 % (1 kHz)
Input impedance:	10 kΩ
Non-destructive max.:	±5 V

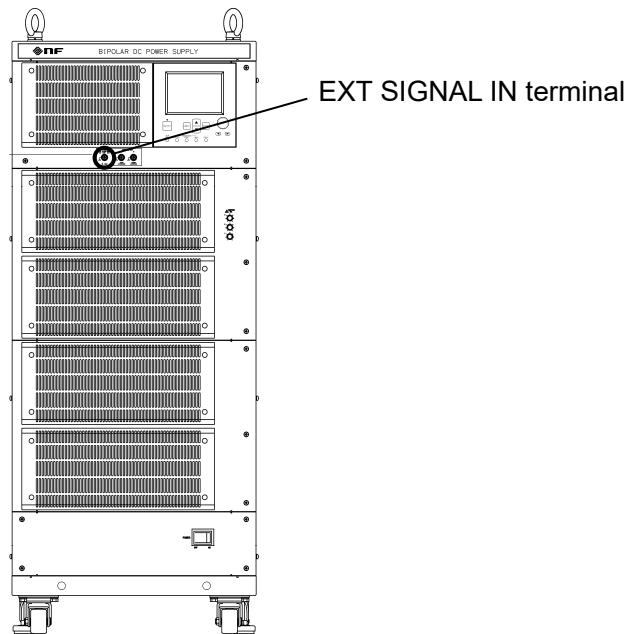

Figure 2-8. EXT SIGNAL IN Terminal

2.4.6 Connection to monitor output pin

To monitor the output voltage and output current, connect the monitor output terminal (MONITOR OUT) on the front panel. For the connection, use a coaxial cable with a BNC connector. To monitor the output voltage, connect this cable to the V_o terminal, and to monitor the output current, connect it to the I_o terminal.

The specifications of the monitor output terminal are as follows.

■ **Output voltage monitor output**

- Monitor ratio: 1/100 of output voltage (1 V/100 V), in-phase (All models)
- Monitor accuracy: ± 1.2 V of output voltage (1 M Ω monitor output load impedance)
- Frequency characteristics: DC to 40 kHz: ± 0.5 dB
40 kHz to 400 kHz: +1 dB, -3 dB
(1 kHz reference, 1 M Ω monitor output load impedance)
- Output impedance: 50 Ω

■ **Output current monitor output**

- Monitor ratio: 1/40 of output current (1 V/40 A), in-phase (BP4640)
1/50 of output current (1 V/50 A), in-phase (BP4650)
- Monitor accuracy: ± 0.8 A of output current (BP4640)
 ± 1 A of output current (BP4650)
(1 M Ω monitor output load impedance)
- Frequency characteristics: DC to 20 kHz: ± 0.5 dB
20 kHz to 200 kHz: +1 dB, -3 dB
(1 kHz reference, 1 M Ω monitor output load impedance)
- Output impedance: 50 Ω

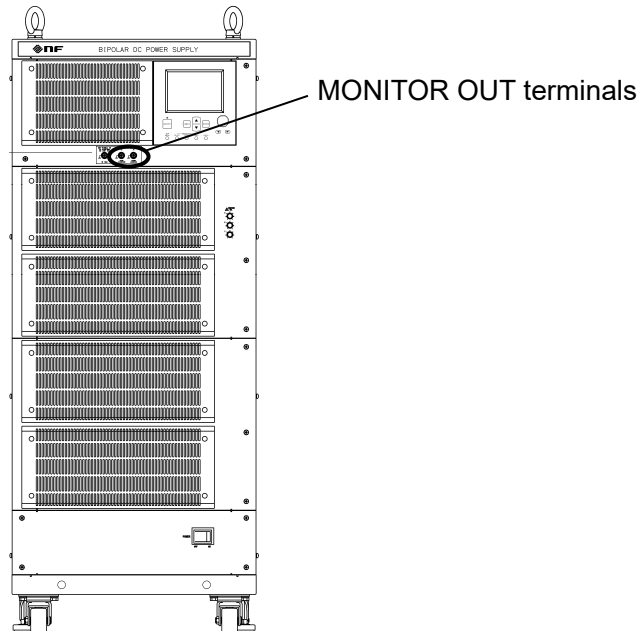
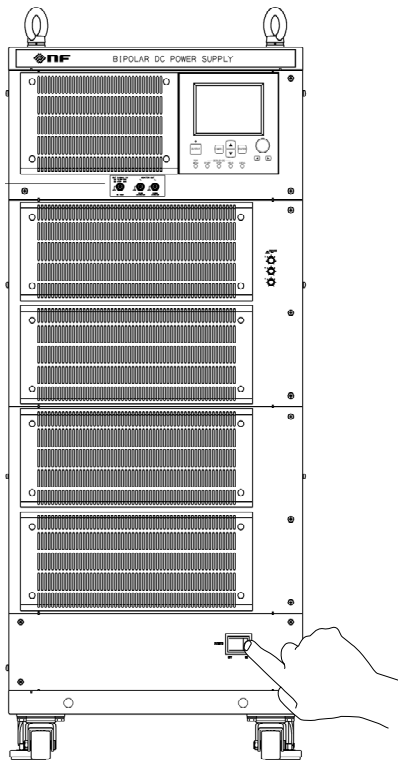

Figure 2-9. MONITOR OUT Terminal

2.5 Power on/off and Operation Check

Once the connections have been completed, check the operation.

- (1) Check whether this product is correctly connected as described heretofore.
- (2) Switch the power switch of this product to on. Power is supplied and this product starts operating.



<1> Press the right side (ON) of the POWER switch



<2> The LCD lights up and the startup screen is displayed

- (3) The operation panel immediately after the power has been switched on shows the same setting values as when the power was switched off the previous time. If this product is switched on for the first time after it is purchased, the internal default settings are applied.
For the operation method to read the setting values saved in the memory,  Refer to “4.7 Memory Functions”.
- (4) To switch the power off, press the left side of the power switch after checking the OUTPUT off status. As a result, the power supply to this product is disconnected and the power is switched off.

 **CAUTION**

- Securely connect all the required cables. Improper connection may cause equipment failure.
 - Before switching the power off, be sure to check that OUTPUT is in the off status.
-

2.6 Radio Law

⚠ CAUTION

- This product complies with the High-Frequency Application Equipment provisions of Japan's Radio Law.
-
- a) Related laws and regulations are summarized as follows.
- Article 100 of the Radio Law defines the following equipment as “high-frequency application equipment”.
 - (1) Telegraphy, telephony, or other telecommunications facilities that apply a radio frequency current of 10 kHz or higher to a power line.
 - (2) Equipment specified by Ministry of Internal Affairs and Communications regulations other than radio equipment and the equipment defined in (1) above, that uses a high-frequency current of 10 kHz or higher.
 - “Ministry of Internal Affairs and Communications regulations” mentioned above refers to Article 45 of the Regulations for Enforcement of the Radio Law. Under this article, equipment that requires authorization is defined as follows.
 - (1) Medical equipment (equipment used for medical treatment that generates high-frequency energy and that uses output greater than 50 W)
 - (2) Industrial heating equipment (equipment used for industrial heating that generates high-frequency energy and that uses output greater than 50 W)
 - (3) Various equipment (equipment that is used for heat generation or ionization and that imparts high-frequency energy to a load)
 - If the usage mode corresponds to “high-frequency application equipment” as defined above, according to Article 26 of the Radio Station License Procedure Regulations, the required application must be submitted to the Bureau of Telecommunications that has jurisdiction over the location where the equipment is installed, and the approval of the Minister of Public Management, Home Affairs, Posts and Telecommunications must be received.
For details, refer to Article 100 of the Radio Law, Article 45 of the Regulations for Enforcement of the Radio Law, Article 26 of the Radio Station License Procedure Regulations, and Article 65 of the Radio Equipment Law.
- b) The application forms and form filling instructions can be obtained at the website of the Bureau of Telecommunications, as well as procedure details and information about other documents to be attached to the application forms.
- c) Applications must be submitted by the person who installed the equipment. Information such as the installation location must be filled in.
- d) The external view drawings or photographs of this product are required as attached documents.

If you have any questions, contact an NF Corporation.

3.NOMENCLATURE

3.1	Nomenclature	3-2
3.1.1	Operation panel	3-2
3.1.2	Front panel	3-4
3.1.3	Rear panel	3-6
3.2	Tilting LCD Screen	3-7

3.1 Nomenclature

3.1.1 Operation panel

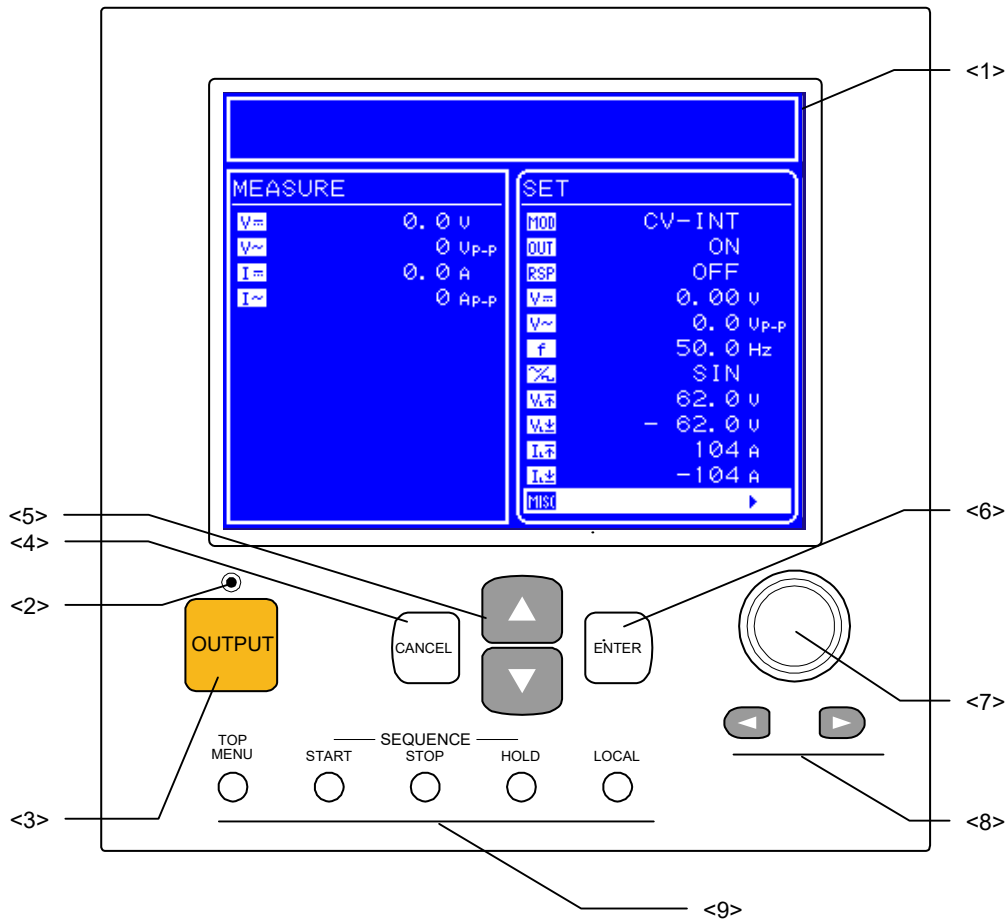

<1> LCD

This is a 320 (horizontal) × 240 (vertical) pixel, blue and white 2-color liquid crystal display. The contrast can be adjusted by operating the operation panel.

Refer to “4.1 LCD Screen”.

<2> On/Off LED

This is a lamp that displays the output on/off status.

It is lit when the output is on and extinguished when the output is off.

Refer to “4.3.2 Output on/off”.

<3> OUTPUT key

This key switches the output on/off.

Refer to “4.3.2 Output on/off”.

<4> CANCEL key

This key is used to cancel operations, close entry boxes, and move one level up at a time in the menu tree.

 Refer to “4.2 Basic Operation”.

<5> UP/DOWN keys

These keys are used to move the cursor in menus and select boxes.

 Refer to “4.2 Basic Operation”.

<6> ENTER key

This key is used to enter settings, open entry boxes, and move one level down at a time in the menu tree.

 Refer to “4.2 Basic Operation”.

<7> MODIFY dial

This dial is used change the value of the digit indicated by the digit cursor in a modify box.

 Refer to “4.2 Basic Operation”.

<8> DIGIT key

This key is used to move the digit cursor in a modify box.

 Refer to “4.2 Basic Operation”.

<9> Shortcut keys

These keys are used to call frequently used functions.

 Refer to “4.2.7 Shortcut key”.

3.1.2 Front panel

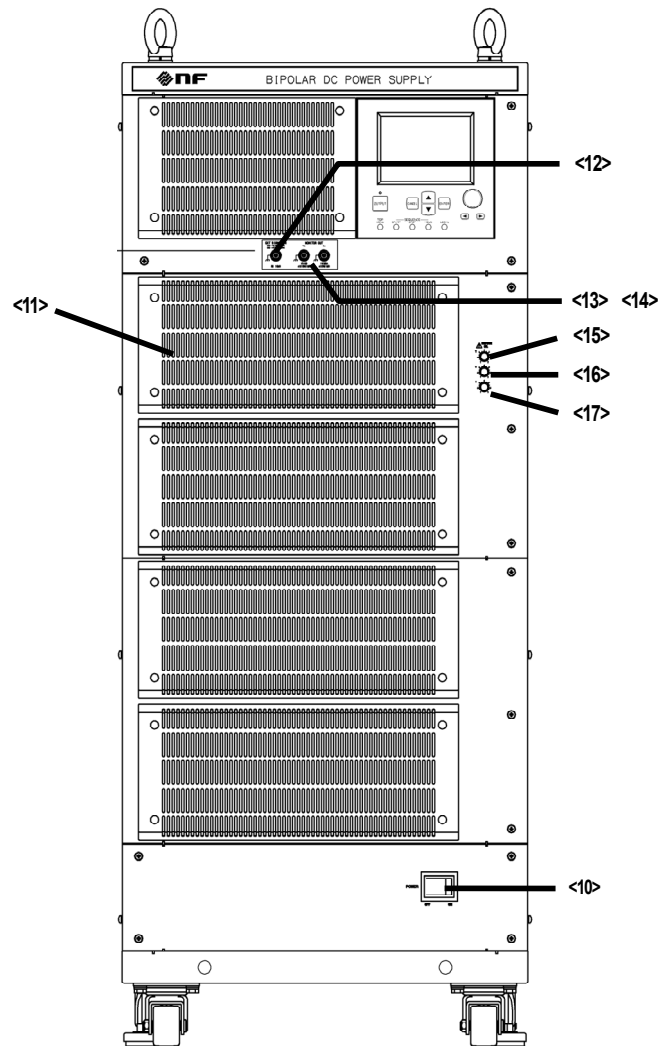

<10> POWER switch

This switch is used to power on/off the this product.

<11> Intake vent

This is the vent for intaking air for cooling this product. Periodically clean the filter.

☞ Refer to “7.5 Cleaning the Air Filter”.

<12> EXT SIGNAL IN

This is the connector used to input an external signal.

☞ Refer to “2.4.5 Connection to external signal input terminal”.

<13> MONITOR OUT-Vo

This is the voltage monitor output terminal.

☞ Refer to “2.4.6 Connection to monitor output terminal”.

<14> MONITOR OUT-Io

This is the current monitor output terminal.

☞ Refer to “2.4.6 Connection to monitor output terminal”.

<15> T volume

This volume is used to adjust the time constant.

☞ Refer to “4.10 Response Calibration”.

<16> V volume

This volume is used to adjust the voltage feedback amount.

☞ Refer to “4.10 Response Calibration”.

<17> I volume

This volume is used to adjust the current feedback amount.

☞ Refer to “4.10 Response Calibration”.

3.1.3 Rear panel

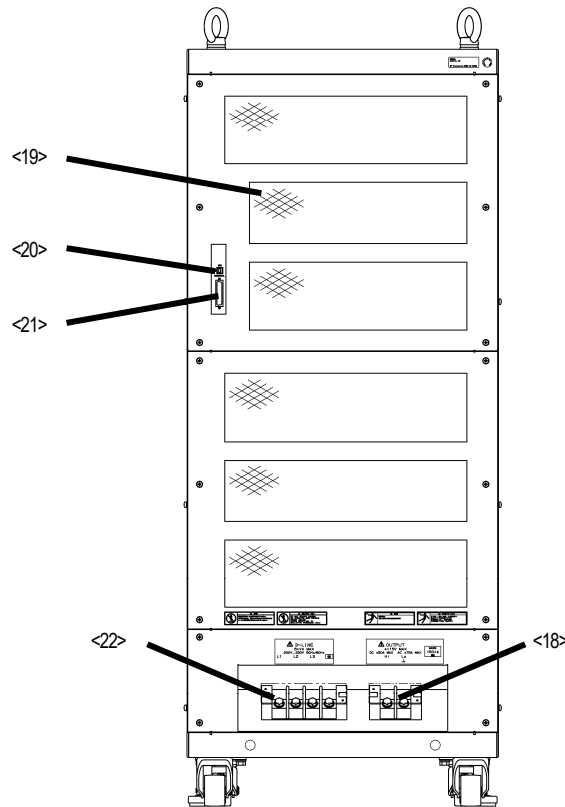

<18> Output terminal

This is the voltage and current output terminal. The Lo side is internally connected to the chassis.

☞ Refer to “2.4.2 Connection to output terminals”.

<19> Exhaust vent

This is the vent for exhausting the cooling air of this product.

<20> USB connector

This is the USB interface connector for controlling this product from an external computer.

☞ Refer to “2.4.3 Connection to USB connector” and “5 USB INTERFACE”.

<21> External control I/O connector

This is the I/O connector used to control output and sequence operation via an external digital signal.

☞ Refer to “2.4.4 Connection to external control I/O connector”.

<22> LINE INPUT

This is the power supply input terminal. Pay attention to the voltage input range.

☞ Refer to “2.4.1 Connection to power supply input terminals”.

3.2 Tilting LCD Screen

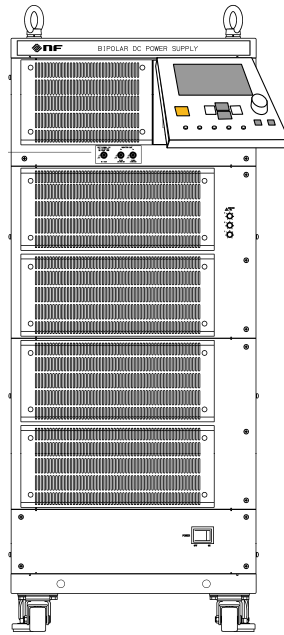
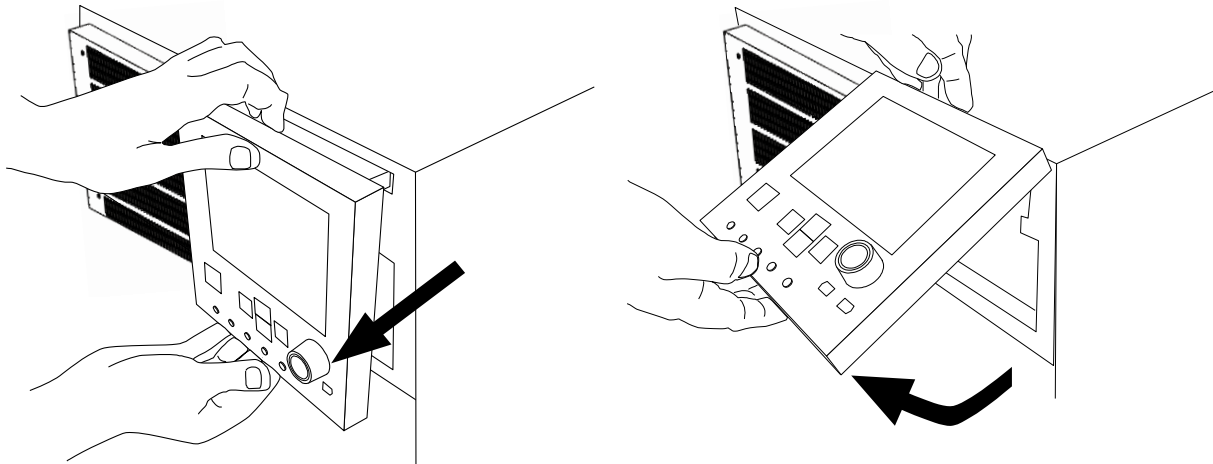

Figure 3-1. Lift Operation Panel

When lifting the operation panel, first gently pull the panel toward you holding its top and bottom. After pulling out the panel until it stops, gently lift up only the bottom of the panel. The operation panel will remain lifted at the angle you have chosen.

■ How to lift the operation panel



- (1) Holding the top and bottom of the operation panel, gently pull it toward you.
- (2) Pull out the operation panel until it stops.

- (3) Then lift up only the bottom of the panel.
- (4) Once the panel is at the desired angle, release it.

Figure 3-2. Operation Panel Lifting Method

CAUTION

- Do not try to lift the operation panel without first pulling it out, as this will damage the panel.
-

How to return the operation panel

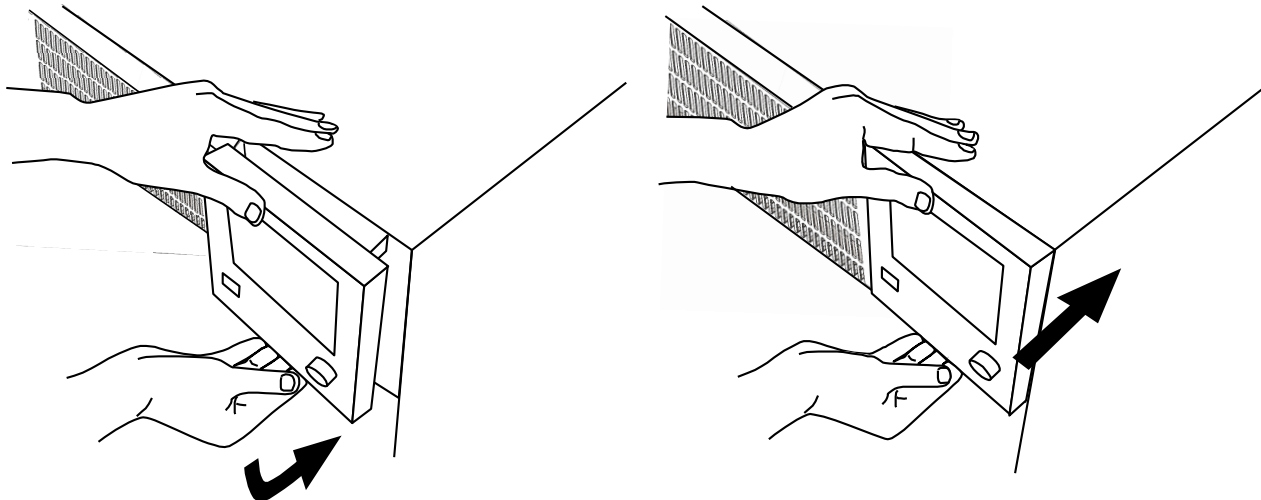

- (1) Holding the top and bottom of the operation panel, gently lower the bottom of the panel.
- (2) Lower the panel until it is parallel with the face of this product.
- (3) Placing your hands on the top and bottom of the operation panel (but not on the LCD screen), push the panel in while keeping it parallel with the face of this product.
- (4) Push the panel in until you hear a clicking sound.

Figure 3-3. Operation Panel Return Method

CAUTION

- Be sure to use both hands when pulling out, lifting, and returning the operation panel.
-

WARNING

- When opening/closing the operation panel, be careful not to get your fingers pinched.
-

4. OPERATION

4.1	LCD Screen	4-3
4.1.1	Status icons	4-4
4.1.2	Warning and error display	4-5
4.1.3	Sequence display	4-5
4.2	Basic Operation	4-6
4.2.1	Menus	4-6
4.2.2	Menu tree navigation method	4-9
4.2.3	Numerical input operation	4-10
4.2.4	Numerical input operation requiring confirmation (during USB ID setting)	4-10
4.2.5	Selective input operation requiring confirmation	4-10
4.2.6	Execution input	4-11
4.2.7	Shortcut keys	4-11
4.3	Basic Functions	4-12
4.3.1	Setting of operation mode	4-13
4.3.2	Output on/off	4-15
4.3.3	Setting of DC voltage and DC current	4-17
4.3.4	Setting of superimposed AC voltage and superimposed AC current	4-18
4.3.5	Setting of frequency	4-21
4.3.6	Setting of waveform	4-22
4.4	Setting of limiters	4-24
4.4.1	Shifting the output voltage range	4-26
4.4.2	Output voltage limiters	4-28
4.4.3	Output current limiters	4-28
4.5	Sequence Operation	4-29
4.5.1	Sequence operation specifications	4-29
4.5.2	Setting of sequence	4-36
4.5.3	Sequence programming	4-38
4.5.4	Sequence operation control	4-43
4.5.5	Sequence memory clear	4-45
4.5.6	Sequence operation setting example	4-46
4.5.7	Sequence operation execution	4-50
4.6	Control via External Control I/O Connector	4-54
4.7	Memory Function	4-55
4.8	Remote Control	4-58
4.8.1	Switching USB interface	4-59
4.8.2	USB ID	4-60
4.8.2.1	USBTMC	4-60
4.8.2.2	USB 488	4-62
4.8.3	Switch to local mode	4-63

4.9	System Menu	4-66
4.9.1	Keylock	4-68
4.9.2	Beep sound	4-69
4.9.3	LCD contrast adjustment	4-70
4.9.4	Setting of LCD display color	4-71
4.9.5	Setting of frequency and time units	4-72
4.9.6	Setting of operation of output and response calibrator at power-on	4-73
4.9.7	Setting of external control input enable/disable	4-74
4.9.8	Reset function	4-75
4.9.9	System information	4-75
4.10	Response Calibration	4-76
4.10.1	Outline	4-76
4.10.2	Fixed characteristics	4-77
4.10.3	Adjustment characteristics	4-78
4.10.4	Adjustment example	4-81
4.11	External Signal Input	4-82
4.12	Voltage and Current Monitor	4-83
4.13	Measurement Function	4-84

4.1 LCD Screen

The LCD on the operation panel is displayed divided into several windows, as shown in Figures 4-1 and 4-2.

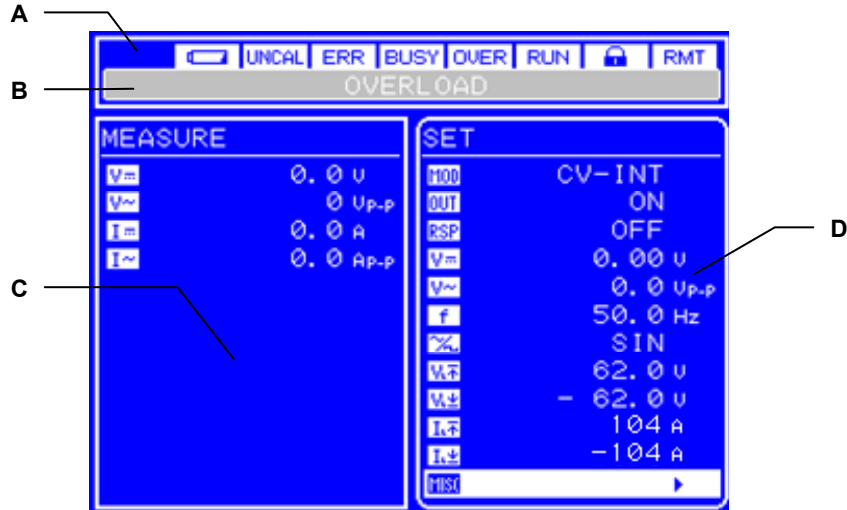

Figure 4-1. LCD Screen (Normal Display)



Figure 4-2. LCD Screen (Warning Display)

4.1 LCD Screen

The various areas of the screen display the following information.















A: Status window:	This area displays the various statuses of this product.
B: Message box:	If an error occurs, a message box appears under the Status window, displaying the cause of the error. The message box automatically closes after 1.5 s. The overload and sequence progress statuses are also displayed in this message box.
C: Measurement Value window:	This area displays measurement values.
D: Menu window:	This area is where settings are performed.
E: Error Message Display window:	If an error that requires confirmation input by the user occurs, a warning message is displayed in the Error Display window. This message continues to be displayed until the [ENTER] key is pressed.

4.1.1 Status icons

Status icons that indicate the status of this product are displayed in the top part of the Status window.

Table 4-1 shows the status icons that are displayed.

Table 4-1. Status Icon List

Icon	Item	Description
	Drained battery	This icon flashes when the battery is judged to be drained upon occurrence of a backup memory sum-check error.
	Calibration data valid/invalid	This icon flashes when the calibration data is invalid.
	Error	This icon lights for a few seconds when an error occurs.
	Busy	This icon lights when the status is busy.
	Overload	This icon flashes during overload.
	Sequence in progress	These icons are displayed in the same location on the operation panel. The icon that is displayed depends on the sequence status, as follows. Idle status: Nothing is displayed. Run status:  is displayed. Hold status:  is displayed.
	Sequence hold in progress	
	Key lock	This icon lights when the key lock is set to on.
	Remote	These icons are displayed in the same location on the operation panel. The icon that is displayed depends on the status of this product. Local: Nothing is displayed. Remote:  is displayed. Local lockout:  is displayed.
	Local lockout	

4.1.2 Warning and error display

Upon occurrence of a warning or error, an error message is displayed in the message box and Message Display window.

For details on error messages,  refer to "6 TROUBLESHOOTING".

4.1.3 Sequence display

This product has a function to display the sequence progress status. The information listed in Table 4-2 is displayed in the message box.

Table 4-2. Sequence Display

Message	Description	Remark
SEQUENCE: RUNNING/STEP ***	Sequence in progress	*** indicates the step number currently being run.
SEQUENCE: HOLDING/STEP ***	Sequence hold in progress	*** indicates the step number that is on hold.
SEQUENCE: FINISH	Sequence end	This message automatically disappears after 2 s.

4.2 Basic Operation

This section describes the basic operation of this product.

4.2.1 Menus

This product provides a hierarchical menu system for setting the various parameters.

Menu operations are performed in the Menu window on the LCD screen.

Figure 4-3 shows the menu tree of this product.

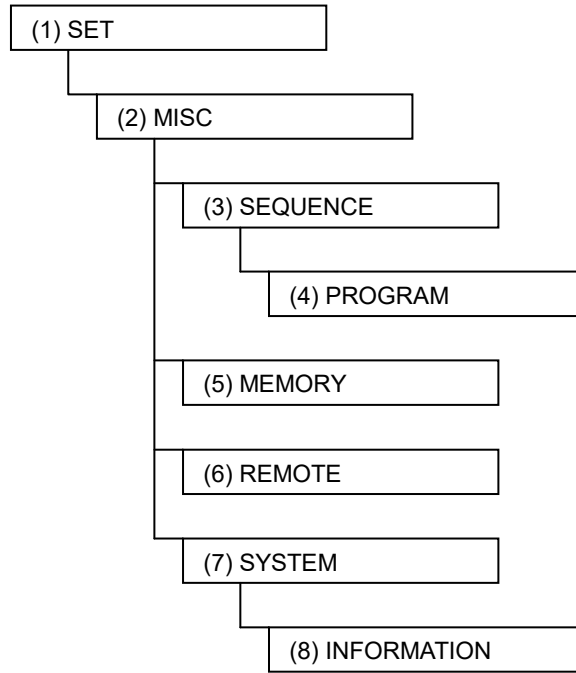

Figure 4-3. Menu Tree

Tables 4-3 to 4-8 show the items displayed in each menu.

4.2 Basic Operation

Table 4-3. SET Menu Item List





























Icon	Item	Reference
	Selection of operation mode	 "4.3.1 Setting of operation mode"
	Selection of output on/off	 "4.3.2 Output on/off"
	Setting of response calibration function	 "4.10 Response Calibration"
	Setting of current voltage to be output	 "4.3.3 Setting of DC voltage and DC current"
	Setting of current voltage to be output	 "4.3.3 Setting of DC voltage and DC current"
	Setting of superimposed AC voltage	 "4.3.4 Setting of superimposed AC voltage and superimposed AC current"
	Setting of superimposed AC voltage	 "4.3.4 Setting of superimposed AC voltage and superimposed AC current"
	Setting of superimposed AC voltage frequency and superposed AC current frequency	 "4.3.5 Setting of frequency"
	Selection of superimposed AC waveform	 "4.3.6 Setting of waveform"
	Setting of + voltage limiter	 "4.4 Setting of limiters"
	Setting of - voltage limiter	
	Setting of + current limiter	
	Setting of - current limiter	
	Setting of other function use and details	 "Table 4-4. MISC Menu Item List"

Table 4-4. MISC Menu Item List

Item Name	Setting Item	Reference
SEQUENCE	Open sequence menu	 "4.5 Sequence Operation"
MEMORY	Open memory menu	 "4.7 Memory Functions"
REMOTE	Open remote menu	 "4.8 Remote Control"
SYSTEM	Open system menu	 "4.9 System Menu"

4.2 Basic Operation

Table 4-5. SEQUENCE Menu Item List





Item Name	Setting Item	Reference	
CONTROL...	Sequence operation control	 "4.5.4 Sequence operation control"	
PROGRAM	STEP	Step number	
	TIME	Step interval	
	DC VOLT	DC voltage	
	DC CUR	DC current	
	–	DC voltage/DC current operation type	
	AC VOLT	Superimposed AC voltage	
	AC CUR	Superimposed AC current	
	–	Superimposed AC voltage/superimposed AC current operation type	
	FREQ	Frequency	
	–	Frequency operation type	 "4.5.3 Sequence programming"
	WAVE	Waveform	
	–	Waveform operation type	
	SYNC CODE	Step sync output	
	–	Step sync output operation type	
	STOP PHS	Step stop phase	
	STEP TERM	Step terminal	
JUMP STEP	Jump step		
JUMP NUM	Jump count		
BRANCH0	Branch 0		
BRANCH1	Branch 1		
MEMORY...	Clear sequence memory	 "4.5.5 Sequence memory clear"	

Table 4-6. MEMORY Menu Item List

Item Name	Setting Item	Reference
STORE...	Store setting contents	 "4.7 Memory Functions"
RECALL...	Recall setting contents	
CLEAR...	Clear setting contents	

4.2 Basic Operation

Table 4-7. REMOTE Menu Item List













Item Name	Setting Item	Reference
INTERFACE	INTERFACE standard	 "4.8.1 Switching USB interface"
VENDOR ID	VENDOR ID	 "4.8.2.1 USBTMC"
PRODUCT ID	PRODUCT ID	
SERIAL NO	SERIAL NO	
USB488 ID	USB488 ID	 "4.8.2.2 USB 488"
LOCAL...	Switch to local mode	 "4.8.3 Switch to local mode"

Table 4-8. SYSTEM Menu Item List

Item Name	Setting Item	Reference
KEYLOCK	Key lock	 "4.9.1 Key lock"
BEEP	Beep	 "4.9.2 Beep sound"
CONTRAST	LCD contrast	 "4.9.3 LCD contrast adjustment"
COLOR	LCD display colors	 "4.9.4 Setting of LCD display colors"
FREQ UNIT	Frequency unit	 "4.9.5 Setting of frequency and time unit"
TIME UNIT	Time unit	
INIT OUT	Output on/off at power-on	 "4.9.6 Setting of output and response calibrator operation at power-on"
INIT RSP	Response calibrator on/off at power-on	
EXT CONTROL	Enable/disable external control input	 "4.9.7 Setting of external control input enable/disable"
RESET...	Reset	 "4.9.8 Reset function"
INFORMATION	Display system information	 "4.9.9 System information"

4.2.2 Menu tree navigation method

The menu window display items are navigated using the [UP] key and [DOWN] key. To move to the lower menu in the menu tree, press the [ENTER] key, and to move to the higher menu in the menu tree, press the [CANCEL] key.

The navigation method is detailed below.

- <1> Select a menu item with the "▶" mark displayed to the right, by moving the menu cursor displayed in the menu window with the [UP] key and the [DOWN] key.
- <2> Pressing the [ENTER] key in this condition causes the lower menu to be displayed.
- <3> Further pressing the [CANCEL] key in this condition causes the higher menu to be displayed again.
- <4> Further pressing the [CANCEL] key ultimately causes the top menu to be returned to.

4.2.3 Numerical input operation

If numerical input is required, a Modify box is displayed.

When this Modify box is opened, the digit cursor is displayed on one of the digits. Using the [DIGIT] key, move the digit cursor and raise or lower the value with the [MODIFY] key. The actual setting value is updated each time the value is changed with the [MODIFY] key. The Modify box is closed by pressing either the [ENTER] key or the [CANCEL] key.

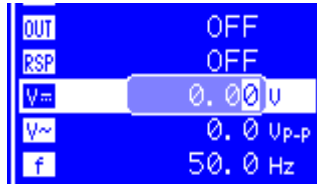

Figure 4-4. Modify Box

4.2.4 Numerical input operation requiring confirmation (during USB ID setting)

The USB ID setting is performed in the Modify box, but the actual setting value is not updated each time the [MODIFY] key is pressed.

By pressing the [ENTER] key to close the Modify box, the setting value is actually updated. If the Modify box is closed by pressing the [CANCEL] key, the updated value is not applied.

Refer to “4.8 Remote Control”.

4.2.5 Selective input operation requiring confirmation

If one item is selected from among various items and set, a Select box is displayed.

When this select box is opened, the selection cursor is displayed over one of the selection items. The selection items are lineup vertically, and the selection cursor is moved by pressing the [UP] and [DOWN] keys.

If there are items that do not fit within the Select box, “▲” and “▼” are displayed at the topmost and bottommost line, respectively. Each time the [UP] or [DOWN] key is pressed, the items are scrolled one item at a time. The selection cursor cannot be moved over the “▲” and “▼”.

The actual setting is updated and the Select box closed by pressing the [ENTER] key. If the Select box is closed by pressing the [CANCEL] key, the changed setting is not applied.

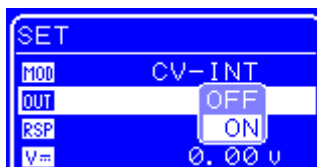

Figure 4-5. Select Box

4.2.6 Execution input

Items that are actually executed by pressing the [ENTER] key are displayed in the Exe box.

Only one item recommended for execution is displayed in the Exe box at a time, and the execution cursor is located over that item.

The item is actually executed when the [ENTER] is pressed, and the Exe box then closes. If the Exe box is closed by pressing the [CANCEL] key, the item is not executed.



Figure 4-6. Exe Box

4.2.7 Shortcut keys

The following operations can be performed using shortcut keys on this product.

Table 4-9. Shortcut Key List

Key No.	Display on Operation Panel	Function
1	TOP MENU	Return to normal display (menu top)
2	START	Start sequence
3	STOP	Stop sequence
4	HOLD	Hold sequence
5	LOCAL	Return to local

For details on the functions of keys No. 2 to 4,  refer to “4.5 Sequence Operation”.

For details on the function of key No. 5,  refer to “4.8.3 Switch to local mode”.

4.3 Basic Functions

This product allows the following functions to be set via the SET screen in the Menu window.

- **MOD**: Selects the operation mode.
(☞ Refer to “4.3.1 Setting of operation mode”.)
- **OUT**: Selects output on/off.
(☞ Refer to “4.3.2 Output on/off”.)
- **V_{DC}**: Sets the DC voltage to be output.
(☞ Refer to “4.3.3 Setting of DC voltage and DC current”.)
- **I_{DC}**: Sets the DC current to be output.
(☞ Refer to “4.3.3 Setting of DC voltage and DC current”.)
- **V_{AC}**: Set the superimposed AC voltage.
(☞ Refer to “4.3.4 Setting of superimposed AC voltage and superimposed AC current”.)
- **I_{AC}**: Sets the superimposed AC current.
(☞ Refer to “4.3.4 Setting of superimposed AC voltage and superimposed AC current”.)
- **f**: Sets the superimposed AC voltage frequency and superimposed AC current frequency.
(☞ Refer to “4.3.5 Setting of frequency”.)
- **WAVE**: Selects the superimposed AC waveform.
(☞ Refer to “4.3.6 Setting of waveform”.)

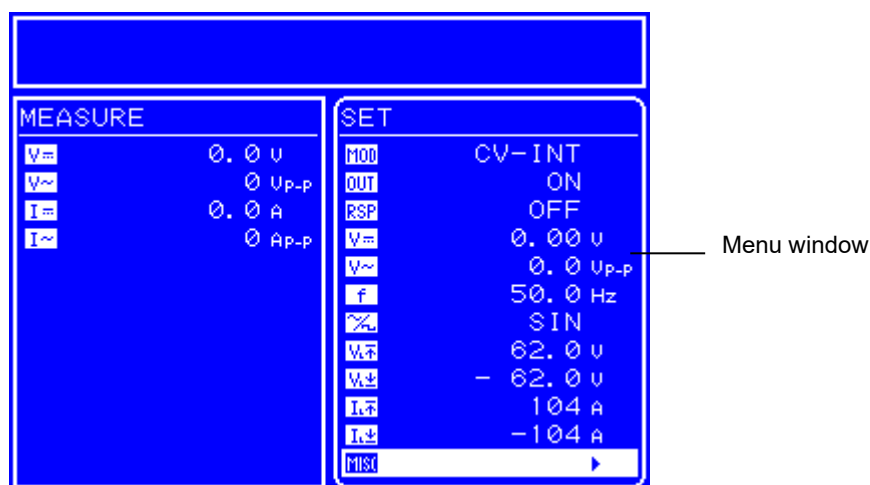

Figure 4-7. LCD Screen

4.3.1 Setting of operation mode

This product has the operation modes listed in Table 4-10. The operation mode cannot be switched during output on. Set the operation mode at output off.

Table 4-10. Operation Mode List

Voltage/Current	Signal Source	Operation Mode
CV (constant voltage)	INT (internal)	CV-INT
	EXT (external)	CV-EXT
	ADD (internal + external)	CV-ADD
CC (constant current)	INT (internal)	CC-INT
	EXT (external)	CC-EXT
	ADD (internal + external)	CC-ADD

■ Setting of voltage/current

This product allows setting of two amplification modes, CV (constant voltage) and CC (constant current).

- CV: Uses this product as a constant voltage source. The voltage is supplied to the load proportionally to the input signal.
- CC: Uses this product as a constant current source. The current is supplied to the load proportionally to the input signal.

■ Setting of signal source

This product can be set to one of three signal source modes, INT (internal), EXT (external), and ADD (internal + external).

- INT: Uses the internal signal source of this product. The DC/AC voltage (current) and the AC frequency waveform set via the menus on the operation panel are output.
- EXT: The waveform is output from the external signal source connected to the external signal input terminal (EXT SIGNAL IN) on the front panel.
- ADD: Outputs the waveform to which the above INT and EXT signal sources have been added.

Figure 4-8 shows the block diagram of the signal source block of the this product.

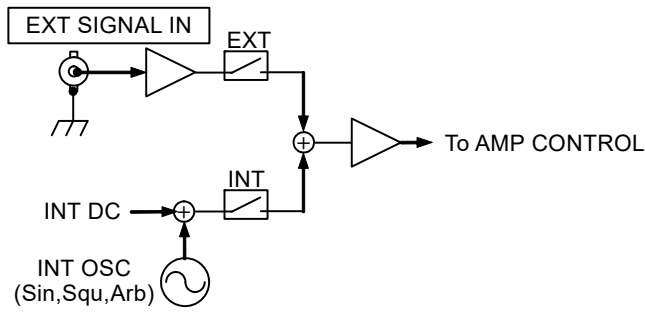
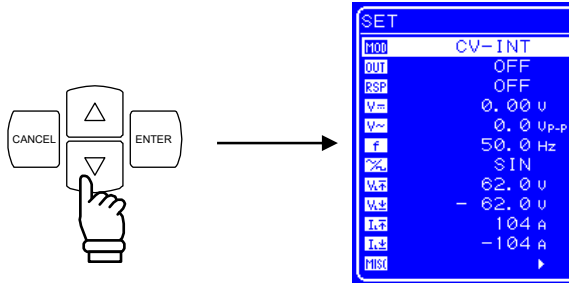

Figure 4-8. Block Diagram of Signal Source Block

■ Operation procedure

<1> Press the and keys to move the cursor to the icon.



<2> Press the key to display the Select box.

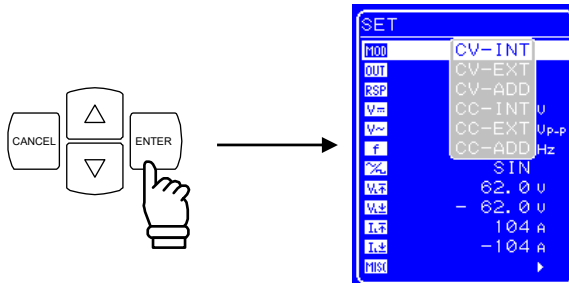

<3> Press the and keys to move the cursor to the mode to be set.

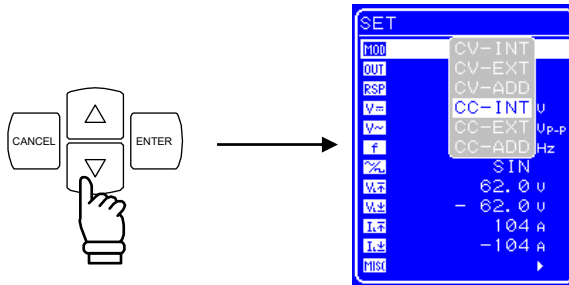

<4> Press the key to set the selected mode.



4.3.2 Output on/off

This product allows output on/off control via the operation panel.

During output on/off switching, the output relay is opened/closed after lowering the output level to 0 in order to reduce contact arcs.

Output on/off is controlled with the following two methods.

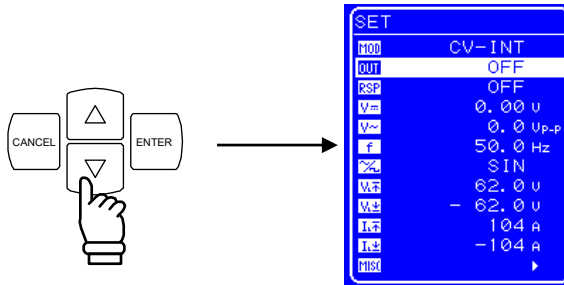

■ **Operation procedure (from menu)**

<1> Press the  and  keys to move the cursor to the **OUT** icon.

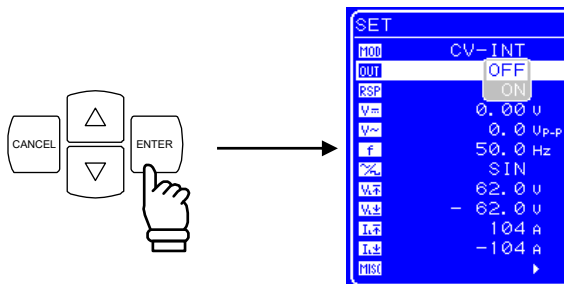

<2> Press the  key to display the Select box.



<3> Press the  and  keys to move the cursor to “ON” if output is current off, and to “OFF” if output is currently on.

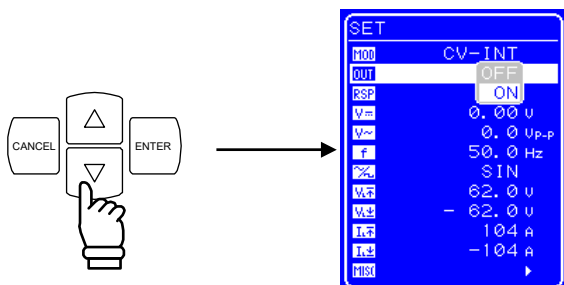

<4> Press the  key to switch the output on/off.

When the output is switched on, the on/off LED lights, and when the output is switched off, the LED goes out.

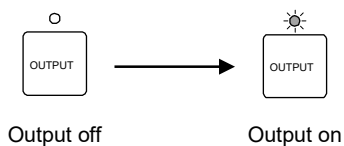

■ Operation procedure (using OUTPUT key)

This product allows output on/off control by simply pressing the  key.

When the output is switched on, the on/off LED lights, and when the output is switched off, the LED goes out.

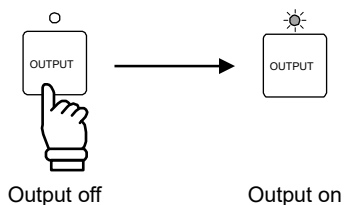

⚠ CAUTION

- When switching the power off, be sure to check that OUTPUT is off.
-

⚠ CAUTION

- When switching the output on and off, pulse voltage output or current output may occur by switching the internal circuit of this product. Therefore, an effect of this voltage or current may occur depending on the load.
 - It is possible to prevent from applying such voltage or current to the load by adding the switch to the output. Please contact NF Corporation or an NF Corporation sales representative for details.
-

4.3.3 Setting of DC voltage and DC current





To use this product as a DC voltage source (CV-INT or CV-ADD mode), set the DC voltage via the operation panel.

- Setting range: -115 V to 115 V
- Resolution: 0.01 V

To use this product as a DC current source (CC-INT or CC-ADD mode), set the DC current via the operation panel.

- Setting range: -40 A to 40 A (BP4640)
-50 A to 50 A (BP4650)
- Resolution: 0.01 A

■ Operation procedure

<1> Press the  and  keys to move the cursor to the  icon (with the DC voltage setting) or the  icon (with the DC current setting).

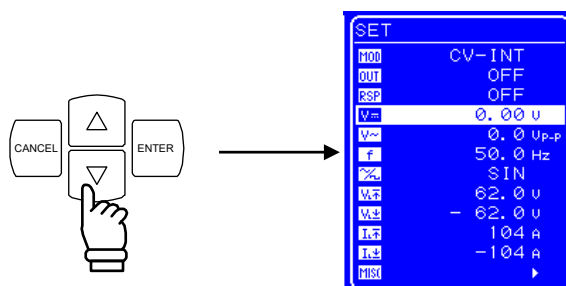

<2> Press the  key to display the Modify box.

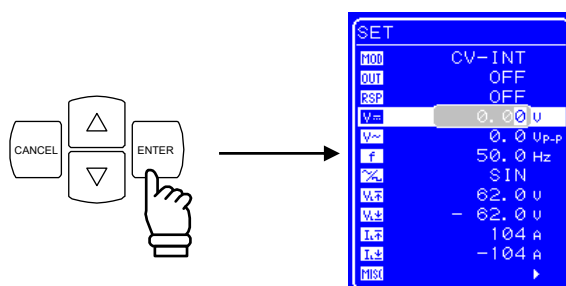

- <3> Press the ◀ and ▶ keys to move the cursor to the digit to be changed and then turn the [MODIFY] dial to set the desired value. When the output is on, the value that is set is immediately reflected to the output.

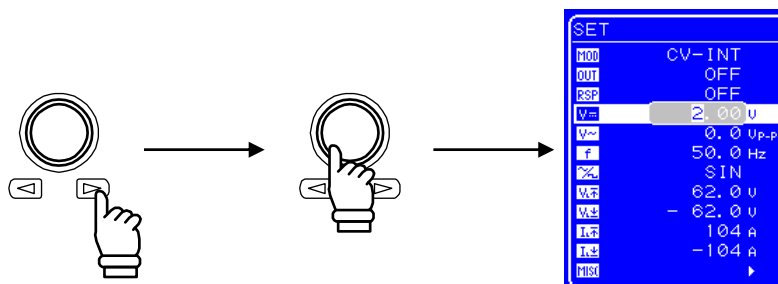

- <4> Once all the digits have been set, press the or key to end the setting procedure.

4.3.4 Setting of superimposed AC voltage and superimposed AC current

To superimpose an AC voltage on the DC output voltage of this product, or to output only an AC voltage (CV-INT or CV-ADD mode), set the superimposed AC voltage via the operation panel.

- Setting range: 0 Vp-p to 120 Vp-p
- Resolution: 0.1 Vp-p

To superimpose an AC current on the DC current of this product, or to output only an AC current (CC-INT or CC-ADD mode), set a superimposed AC current via the operation panel.

- Setting range: 0 Ap-p to 120 Ap-p (BP4640)
0 Ap-p to 150 Ap-p (BP4650)
- Resolution: 0.1 Ap-p

■ Operation procedure

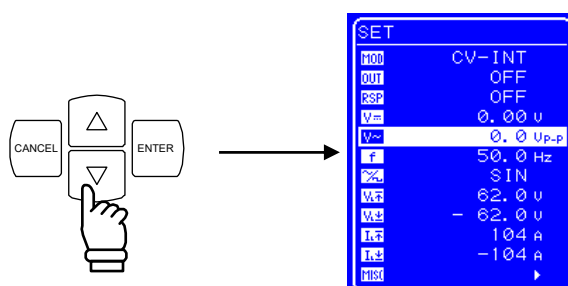

- <1> Press the and keys to move the cursor to the (when superimposed AC voltage is set), or the (when superimposed AC current is set).

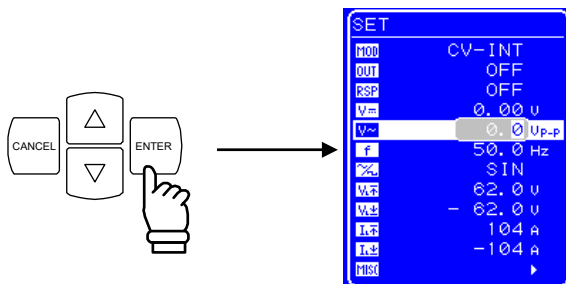

4.3 Basic Functions

<2> Press the  key to display the Modify box.



<3> Press the  and  keys to move the cursor to the digit to be changed, and then turn the [MODIFY] dial to set the desired value. When the output is on, the value that is set is immediately reflected to the output.

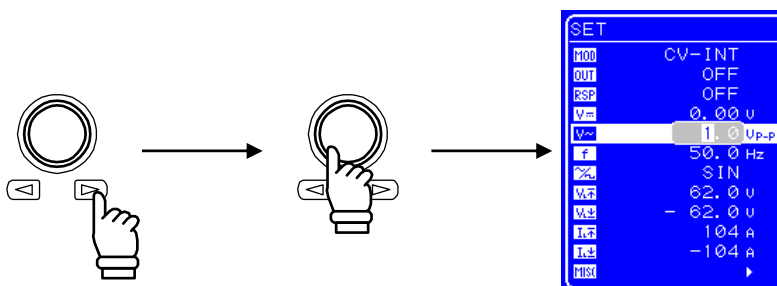

<4> Once all the digits have been set, press the  or  key to end the setting procedure.

■ Setting value and actual output

Since the output of this product is influenced by the frequency characteristics of the amplification block, a difference occurs between the amplitude setting value and the actual output amplitude in the case of a high frequency.

Figure 4-9 shows the relationship (representative example) between the setting values on the operation panel and the actual output values.

The frequency characteristics vary according to the load condition, response characteristics, output waveform, load cable length, etc.

Output voltage frequency characteristics in CV mode

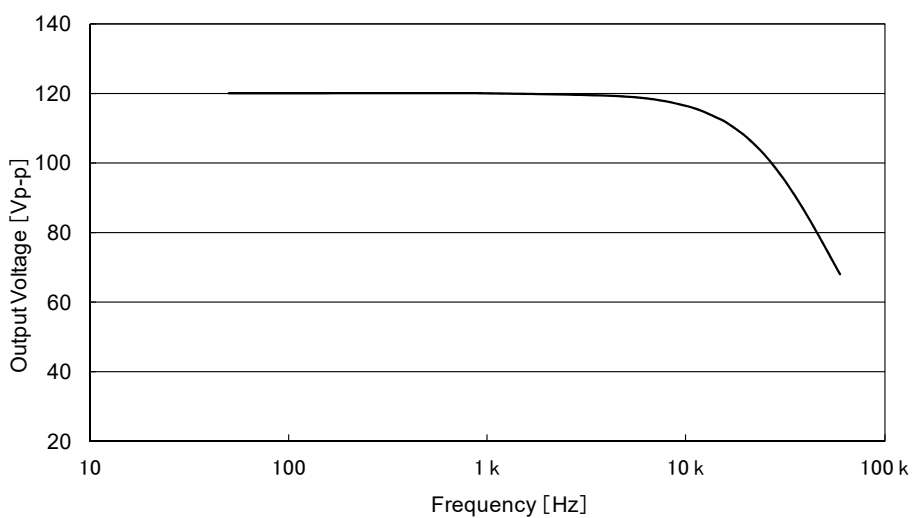

Output current frequency characteristics when in CC mode

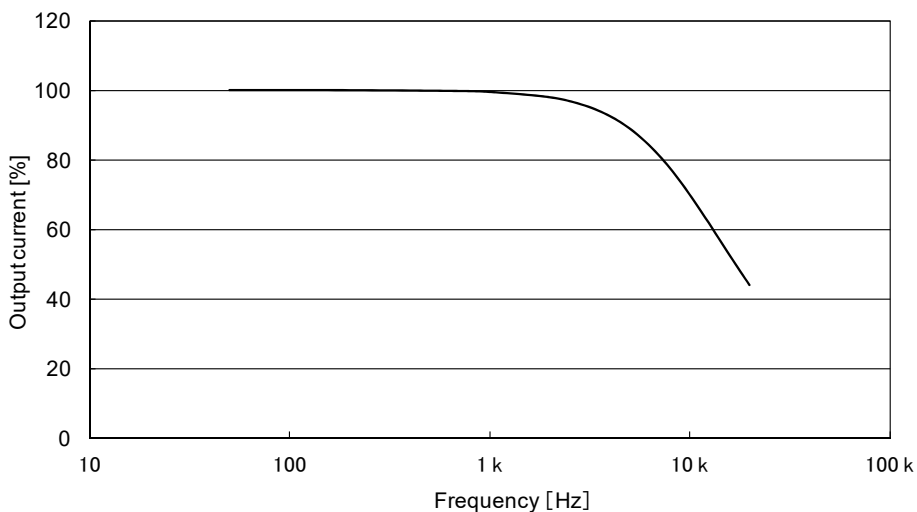

Figure 4-9. Frequency Characteristics for Resistance Load in CV and CC Modes

Remark: The vertical axes current value at 100% of the figures of CC mode, and resistance load of each models are following.



Item	BP4640	BP4650
Current	80 Ap-p	100 Ap-p
Resistance load	1.5 Ω	1.2 Ω

4.3.5 Setting of frequency

When superimposed AC voltage and superimposed AC current are generated, the superimposed AC voltage frequency and superimposed AC current frequency can be set via the operation panel.

- Setting range: 1 Hz to 100 kHz
- Resolution: 0.1 Hz

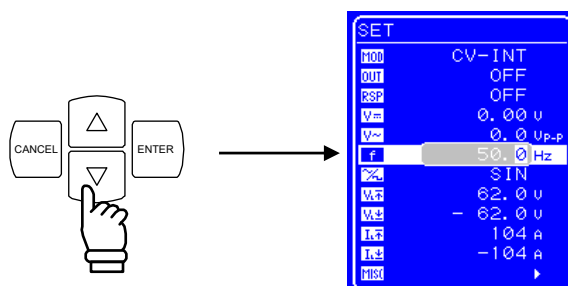

■ Operation procedure

<1> Press the  and  keys to move the cursor to the  icon.

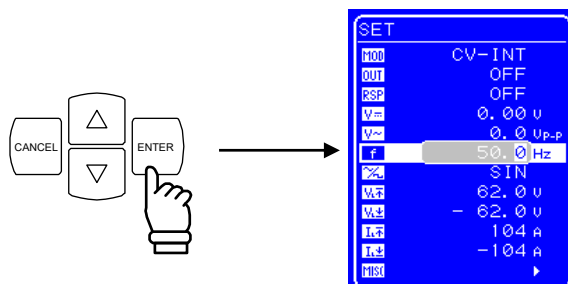

<2> Press the  key to display the Modify box.



<3> Press the  and  keys to move the cursor to the digit to be changed, and then turn the [MODIFY] dial to set the desired value. When the output is on, the value that is set is immediately reflected to the output.

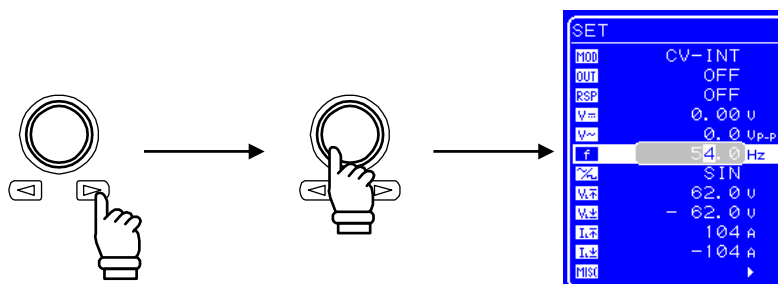

<4> Once all the digits have been set, press the  or  key to end the setting procedure.



4.3.6 Setting of waveform

This product allows selection of a sine wave, square wave, or one of 16 arbitrary waves as the waveform to be output, via the operation panel. Arbitrary waves are created through data transfer via the USB interface. When output is on, the superimposed AC voltage waveform and superimposed AC current waveform cannot be changed. To change the waveform, set switch off the output. The waveforms listed in Table 4-11 can be selected.

Table 4-11. Superimposed AC Voltage Waveform and Superimposed AC Current Waveform List

Display on Operation Panel	Type
SIN	Sine wave
SQU	Square wave
ARB1 to ARB16	Arbitrary wave (16 types)

■ Operation procedure

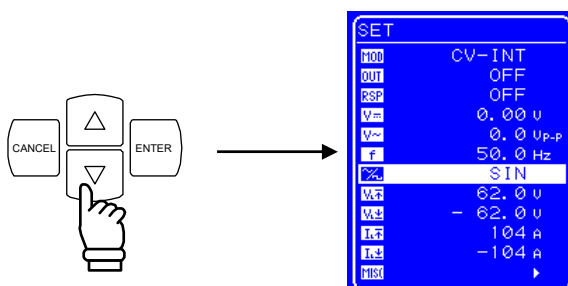

<1> Press the  and  keys to move the cursor to the  icon.



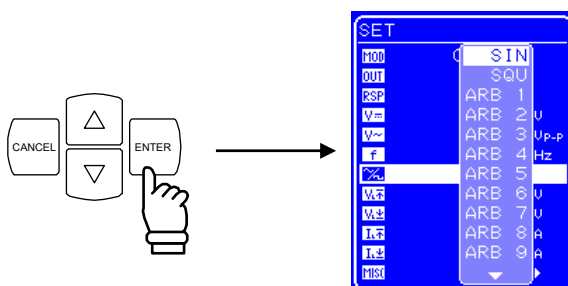

<2> Press the  key to display the Select box.

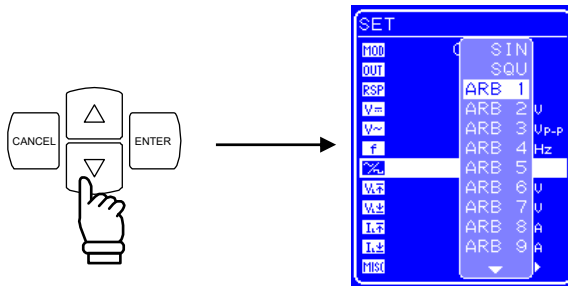

4.3 Basic Functions

<3> Press the  and  keys to move the cursor to the waveform to be output.



<4> Press the  key to set the selected waveform.

4.4 Setting of limiters

To protect the load, this product has output voltage and output current limiter functions implemented through hardware.

The maximum values for the output voltage and output current can each be set independently for the negative and positive range. Limiting the output voltage and current to the set values is effective for preventing failure of the connected load.

Limiter setting values are separately stored in the CV and CC modes.

For details on the output voltage and output current supply ranges, refer to “8.19 Output Voltage and Output Current Supply Ranges”.

Table 4-12. Limiter Setting Ranges

Model	Setting Item	Min.	Max.	Resolution	Initial Value	Setting accuracy (DC) *1
All models	+ voltage limiter	7.0 V	117.0 V	0.1 V	62.0 V	±1 V
	- voltage limiter	-117.0 V	-7.0 V	0.1 V	-62.0 V	
BP4640	+ current limiter	4 A	104 A	1 A	104 A	±4 A
	- current limiter	-104 A	-4 A	1 A	-104 A	
BP4650	+ current limiter	5 A	130 A	1 A	130 A	±5 A
	- current limiter	-130 A	-5 A	1 A	-130 A	

*1 The setting accuracy of the current limiter is within the following DC current.

Item	BP4640	BP4650
Current	±40 A	±50 A

■ Output voltage range

The output voltage range of this product is determined by the \pm voltage limiter settings.

The maximum and minimum ranges of the \pm voltage limiter are limited to 124 V and 24 V, respectively, and are reciprocally linked.



■ Saving of output voltage/output current setting values

Limiter setting values are separately stored in the CV and CC modes.

⚠ CAUTION

- During output of a high frequency (higher than approx. 1 kHz in the case of a sine wave), note that the output may exceed the limiter level due to limiter operation delay.

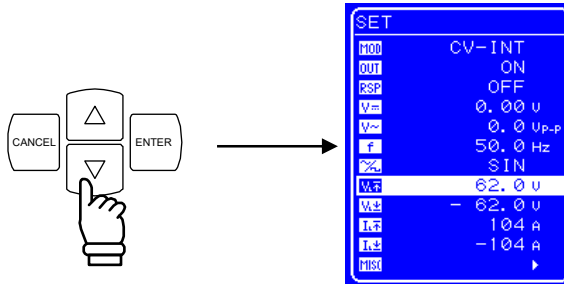

■ Operation procedure (for setting + voltage limiter)

<1> Press the  and  keys to move the cursor to the  icon.

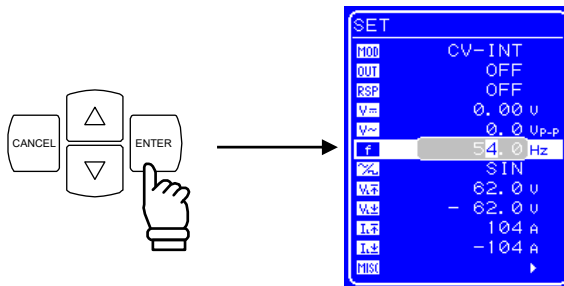

<2> Press the  key to display the Modify box.



<3> Press the  and  keys to move the cursor to the digit to be changed, and then turn the [MODIFY] dial to set the desired value. When the output is on, the value that is set is immediately reflected to the output.

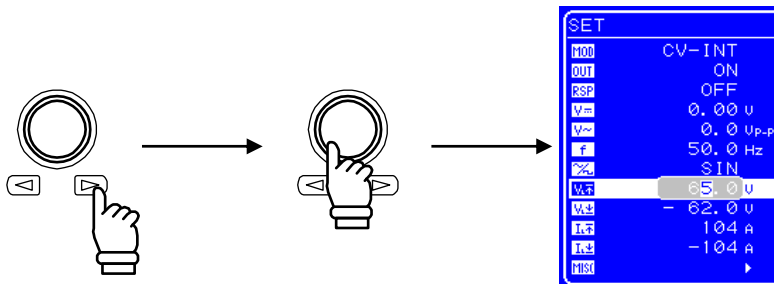

<4> Once all the digits have been set, press the  or  key to end the setting procedure.

4.4.1 Shifting the output voltage range

The output voltage range can be shifted through the voltage limiter settings. The output voltage width can be shifted to any position from -115 V to +115 V within the maximum output voltage range of 120 Vp-p. (However, on the negative side, it is limited to -5 V max., and on the positive side, it is limited to +5 V max.)

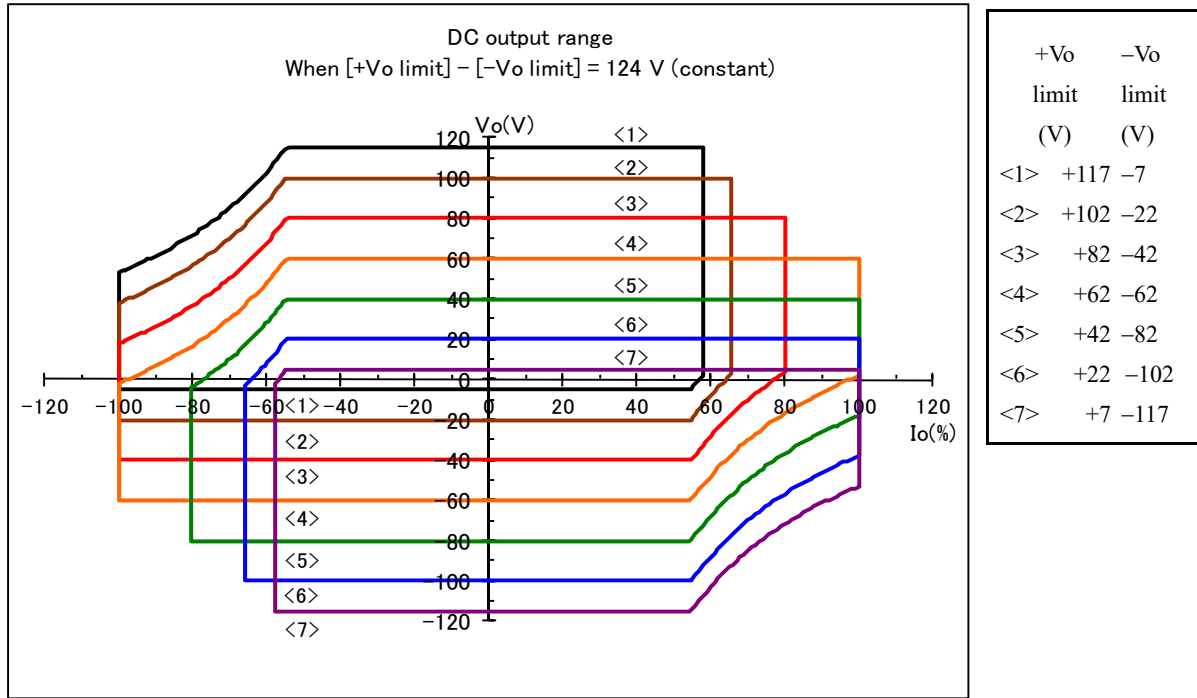

Figure 4-10. DC Output Range (When Positive/Negative Voltage Limiter Setting Difference Is Fixed to 124 V)

As shown in Figure 4-10, the output current range changes according to the output range.

In the case of this product, the DC power supply voltage of the amplifier changes according to the voltage limiter value, to obtain an output that is as large as possible. The outputable power is maximum when the limiter width is set to the maximum of 124 V. Note that in a case such as the one shown in Figure 4-11, the maximum output current does not increase as much as shown in Figure 4-10 even if the positive voltage limiter is lowered.

The horizontal axes of Figure 4-10 and Figure 4-11 are the ratios (%) to the following current value.

Item	BP4640	BP4650
Current	40 A	50 A

4.4 Setting of limiters

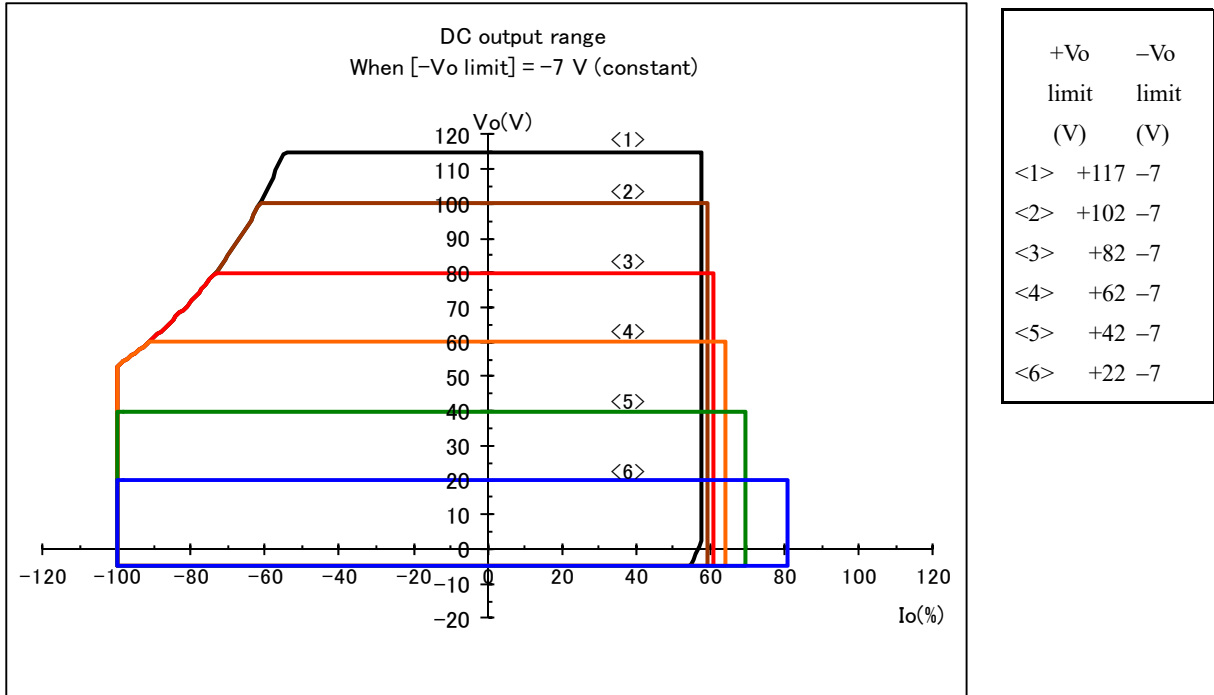

Figure 4-11. DC Output Range (When Negative Voltage Limiter Setting Is Fixed to -7 V)

If this product is to emphasize the 2nd quadrant or 4th quadrants taking in power (to maximize the take-in power amount), lower the negative voltage limiter as much as possible for the 2nd quadrant, or the positive voltage limiter for the 4th quadrant.

4.4.2 Output voltage limiters

By setting output voltage limiters, the maximum output voltage is limited, and the output voltage and output current supply ranges are determined. Depending on the operating conditions, the output voltage may be limited to a narrow range due to the voltage limiter settings. (Refer to “8.19 Output Voltage and Output Current Supply Ranges”.)

The difference between the positive voltage setting and the negative voltage setting is limited to 24 V or higher and 124 V or under.

The specifications of the output voltage limiters are as shown in Table 4-12.

4.4.3 Output current limiters

The maximum output current can be limited through output current limiter settings. The source current is positive.

Depending on the operating conditions, the output current may be limited to a narrow range due to the current limiter settings. (Refer to “8.19 Output Voltage and Output Current Supply Ranges”.)

The specifications of the output current limiters are as shown in Table 4-12.

CAUTION

- When the set value of the current limiter is small, if output of a signal with a sharp rise and fall, such as a square wave, is attempted, the current limiter may switch on at the charging current of the stray capacitance, even with no load, and the output waveform may deform or overload may occur. In such a case, make the set value of the current limiter large.
-

4.5 Sequence Operation

4.5.1 Sequence operation specifications

This product allows the output voltage and output current to be freely programmed using the sequence function.

In addition to basic oscillation, the sequence function can be used as the signal source of the power supply for specification testing, such as power supply environment testing and automotive electronics testing. For example, by programming in advance a series of voltage change patterns for use in voltage variation testing for electrical equipment, the output can be cycled through variations according to a preset sequence, allowing testing to be completed through a single operation.

The internal DC (direct current), sine wave, square wave, or any of 16 arbitrary waveforms loaded via the USB interface can be used for the sequence operation. The sequence can be set to up to 255 steps (1 step = 0.1 ms minimum), and the waveform, level, duration, and constant/sweep settings can be selected individually for each step. Moreover, repetition of the sequence can be specified between 1 to 999 times (or continuous).

Additional functions including branch operation, which causes the operation to go to the specified step during sequence operation, sequence start, stop, and hold, are also provided.

Number of sequences:	1 sequence each for the CV mode and CC mode
Number of steps:	1 to 255 (within 1 sequence)
Step time:	0.1 ms to 999.9999 s (resolution: 0.1 ms)
Operation within step:	Constant or linear sweep
Parameters:	CV mode: DC voltage, superimposed AC voltage, frequency, waveform, step sync output (2-bit) CC mode: DC current, superimposed AC current, frequency, waveform, step sync output (2-bit)
Remark:	If a sine wave or square wave is selected as the waveform, the waveform cannot be changed during the sequence. If arbitrary waveform is selected, an arbitrary wave can be specified for each step.
Jump count:	1 to 999, or continuous
Sequence control:	Start: Starts sequence. Stop: Stops sequence. Hold: Maintains settings at that point in time. The operation resumes at sequence start. Branch: Branches to the specified step.

4.5 Sequence Operation

■ Sequence

A sequence consists of two or more steps, with the minimum unit constituting one step. The superimposed AC phase is continuous as steps change.

■ Step

Step execution and step transition parameters are described for each step. Even in the status where no sequence is being executed, in other words regular output, the same parameters as for steps are held. These parameters are subsequently used as regular output steps. In the following description, step parameters are enclosed in [].

The step execution parameters specify the output and its behavior.

Table 4-13. Step Execution Parameters

[Output parameters]	<ul style="list-style-type: none"> • DC voltage (current) • Superimposed AC voltage (current) • Frequency • Waveform (ARB only) • Step sync output
[Step operation types]	<p>The following items are provided as output behavior specifications for each step.</p> <ul style="list-style-type: none"> • Constant (CONST) • Sweep (SWEEP) • Output using end value of previous step (KEEP)^{Note}

Note If KEEP is selected for [Step operation type], the [Output parameters] settings are ignored.

4.5 Sequence Operation

The step transition parameters specify the next step and the transition timing.

Table 4-14. Step Transition Parameters

[Step time]	Specifies the step transition as a time.
[Step end phase]	Enables/disables the step end phase. If this parameter is set to enable, the step end phase is fixed to 0 deg.
[Step termination]	The following settings are provided for specifying the behavior upon step end. <ul style="list-style-type: none"> • Continue sequence (CONT) • Enter Hold status (HOLD) • Enter Idle status (STOP)
[Jump step]	The following settings are provided for specifying the step to be transitioned at the end of a step. <ul style="list-style-type: none"> • Go to any step number (1 to 255) • Go to next step number (0)
[Jump count]	A loop is realized by jumping the specified number of times to the step specified with [Jump step]. The following settings are provided for specifying the jump count. <ul style="list-style-type: none"> • Specified count (1 to 999) • Infinite count (0)
[Branch step]	The following settings are provided for specifying the step to be transitioned to through branch control. <ul style="list-style-type: none"> • Go to any step number (1 to 255) • Continue step processing as is (0)

When start control is performed in the regular output status when the status is Idle, Step 1 is executed and the steps cycle in the set order.

If [Jump step] is not specified, the steps are executed in the step number order, but if [Jump step] is specified, that step is transitioned to.

The step end is when the [Step time] has elapsed. If [Step end phase] is enabled, the step end is when [Step end phase] (0 deg) occurs following the lapse of the [Step time].

If both [Step termination] and [Jump step] are specified, the [Step termination] specification has precedence.

A basic step transition example is shown below.

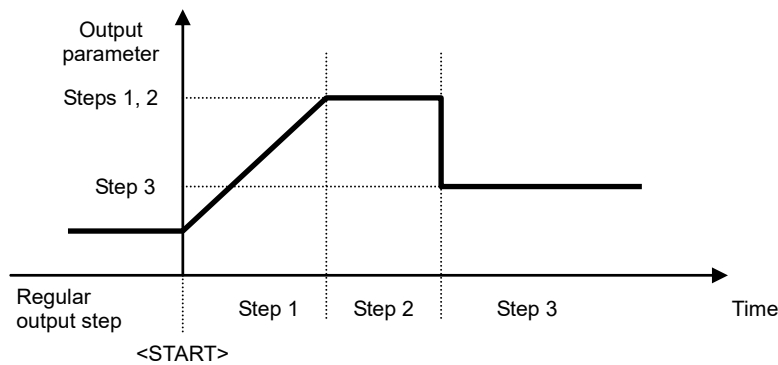

Figure 4-12. Basic Step Transition Example

■ Sequence status

Figure 4-13 shows a sequence operation status transition diagram.

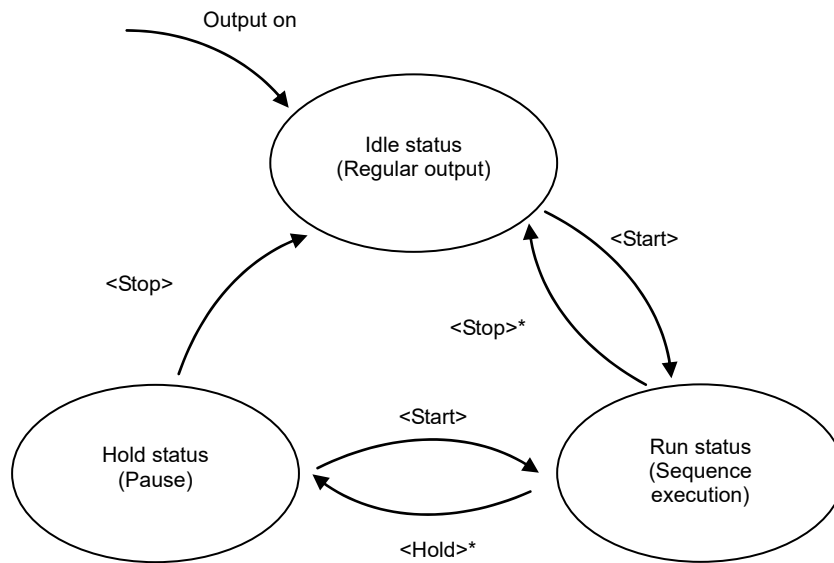

Figure 4-13. Sequence Status Transition Block Diagram

----- Comment -----
 ● The status can also be changed through [Step termination] specification.

Table 4-15. Sequence Statuses

Idle status	Status in which regular output is performed.
Run status	Status in which sequence is executed.
Hold status	Status in which sequence is paused. The output is held at the point in time when <Hold> is executed.

4.5 Sequence Operation

■ Sequence control

Sequence operation control is described below. Sequence control is indicated enclosed between pointed brackets (<>) below.

Table 4-16. Sequence Control

<Start>	<p>Changes the status to Run status.</p> <p>In the case of the Idle status, Step 1 is jumped to at the same time as <Start>, and the sequence starts.</p> <p>In the case of the Hold status, the sequence resumes from the point in time when <Hold> is executed.</p> <p>If the status changes to the <Hold> status with [Step termination], the status changes to [Jump step] at the same time as <Start> and the sequence restarts.</p>
<Hold>	The status changes to the Hold status.
<Stop>	<p>The status changes to the Idle status.</p> <p>The status immediately changes to regular output step.</p> <p>At this time, the value at <Stop> is held for the [Output parameter] of the regular output step.</p>
<Branch>	<p>The step changes to the step specified with [Branch step].</p> <p>The status changes [Branch step] from the output status at the point in time when <Branch> was executed.</p>

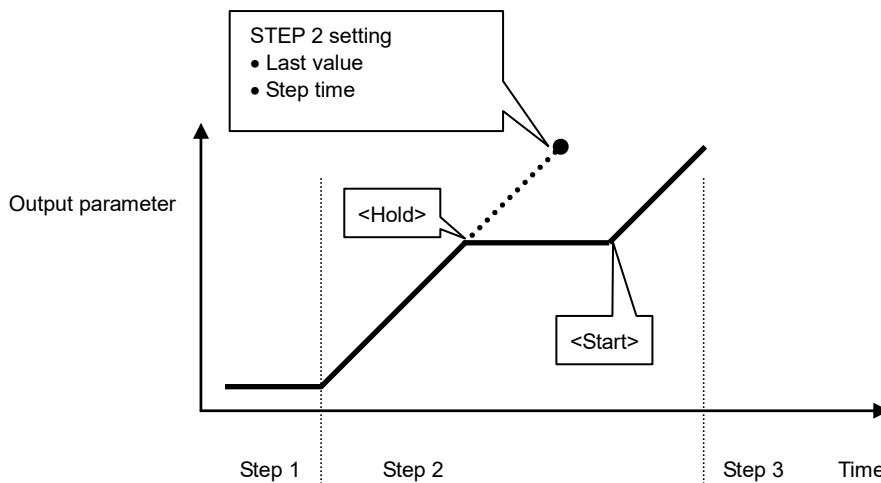

Figure 4-14. Example of Sequence Operation When <Start> Is Executed from Hold Status

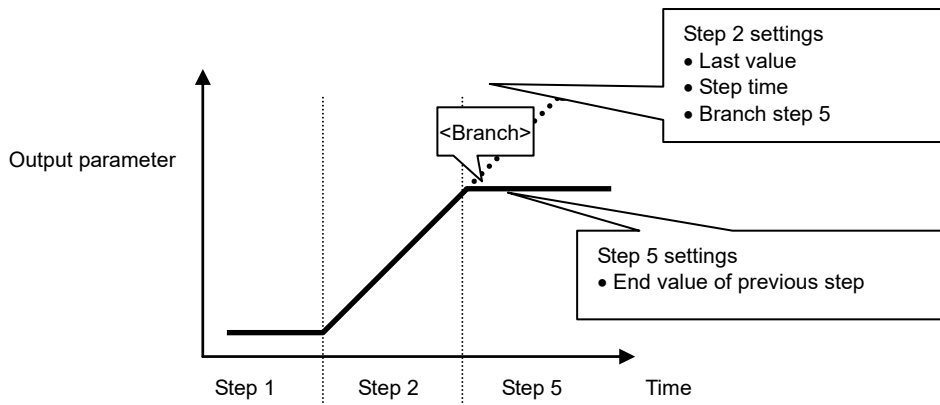

Figure 4-15. Example of Sequence Operation During <Branch>

■ Sequence loop

Sequence loop also allows the entire sequence or any step block within the sequence to be looped. This is achieved with [Jump step] and [Jump count] specified for each step. A jump counter for counting the number of jumps is held internally for each step, so multiloop is also possible.

Figure 4-16 shows the loop specification method and the step transitions.

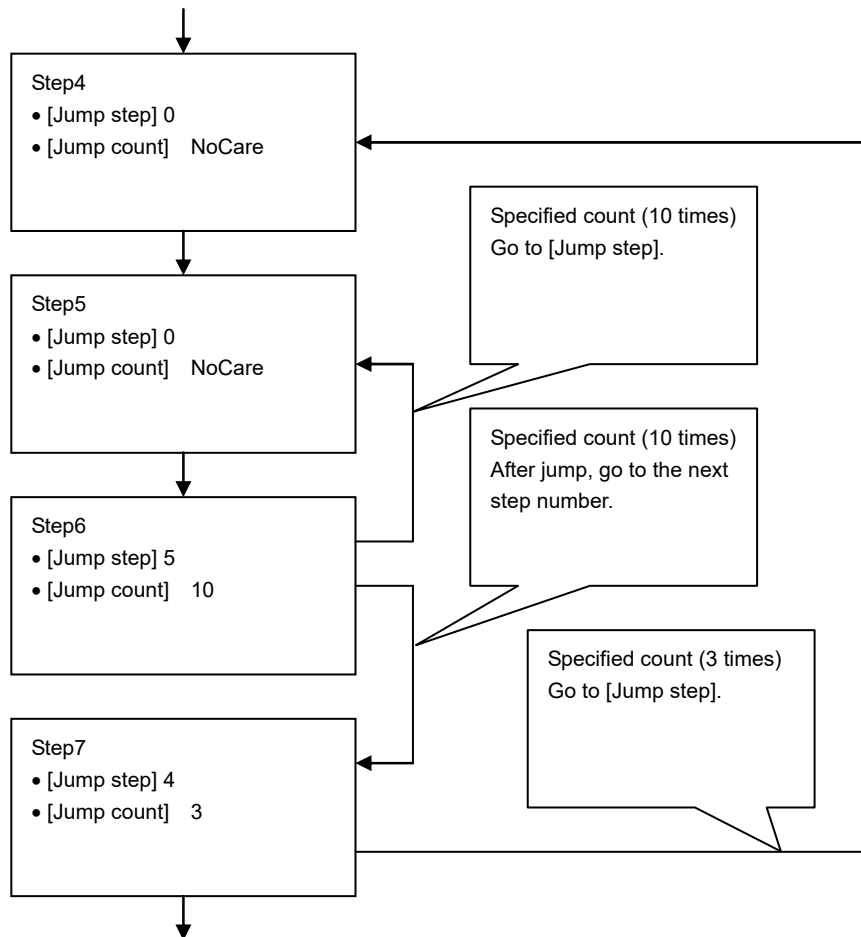

Figure 4-16. Loop Specification Method and Step Transition Example

----- Comment -----

- [Jump count] indicates the number of times jump is to be performed. Therefore, the loop count is equal to the jump count + 1.
 - In the above example, the jump count is specified as “10” in Step 6, so the number of times Step 5 and Step 6 are executed is 11.
-

■ Step sync output

The code described in the step under execution is output to the external control I/O connector. However, “False” is output during regular output steps.

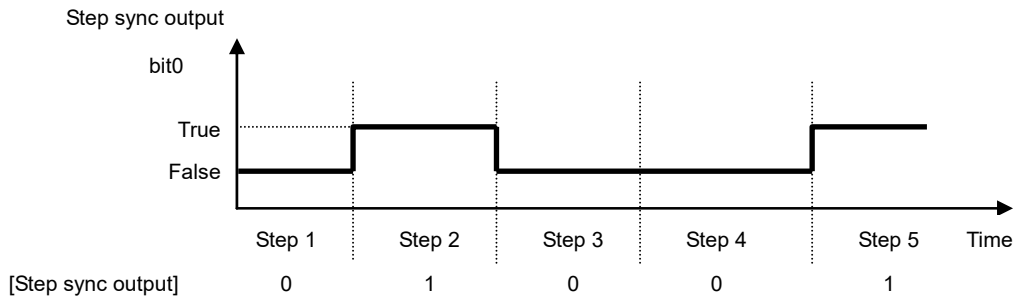

Figure 4-17. Step Sync Output Example

■ Setting of step end phase

If the step end phase has been enabled, the step execution time is as follows.

Time until the set step time + superimposed AC phase becomes 0deg.

Moreover, the operation after the set step time has elapsed is held to the setting value for that step.

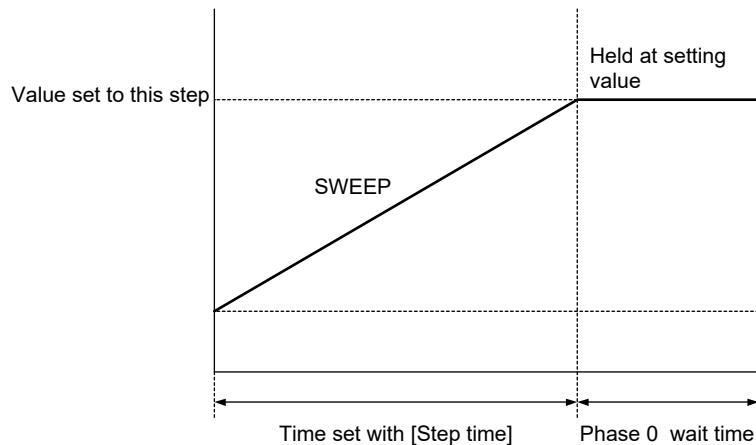

Figure 4-18. Sequence Operation upon Phase 0 deg Wait Occurrence

4.5.2 Setting of sequence



The sequence setting method is described below.

- Input at every step via operation panel
- Programming on PC and transmission to this product via USB
- Creation of sequence data with sequence editing software (sold separately) and transmission to this product

For details on the program messages during sequence operation, refer to “5.3.3 Sequence Related”.



The operation method via the operation panel is described below.

■ Sequence menu display procedure

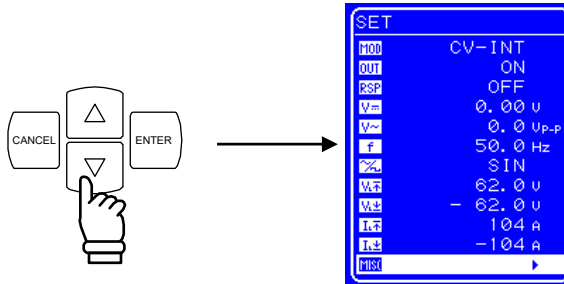
<1> Press the  and  keys to move the cursor to the  icon.



<2> Press the  key to display the MISC screen.

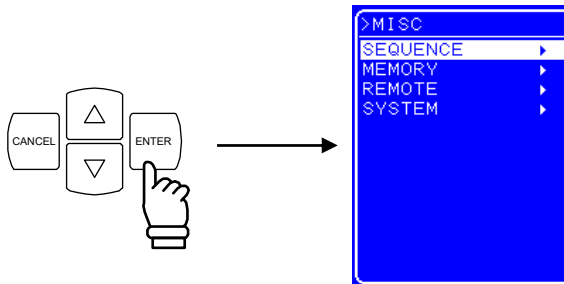

Press the  and  keys to move the cursor to [SEQUENCE].



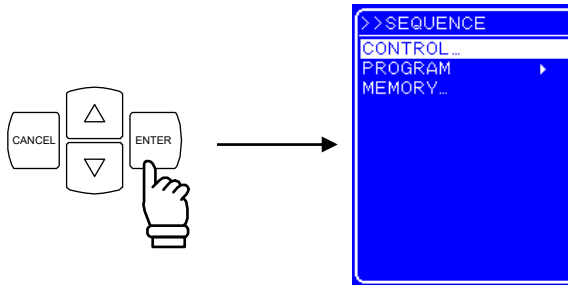

4.5 Sequence Operation

<3> Press the  key to display the SEQUENCE screen.



<4> Press the  and  keys to select the operation to be performed.

- To control a sequence operation: Select [CONTROL].
( Refer to “4.5.4 Sequence operation control”.)
- To program a sequence: Select [PROGRAM].
( Refer to “4.5.3 Sequence programming”.)
- To control the sequence memory: Select [MEMORY].
( Refer to “4.5.5 Sequence memory clear”.)

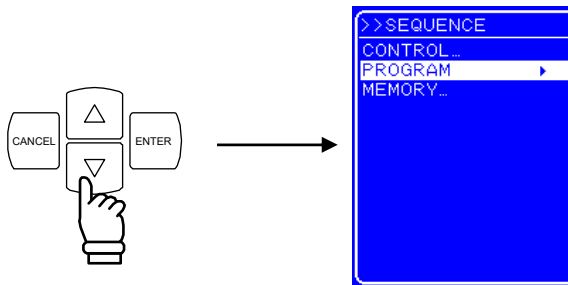

<5> Press the  key to display the various screens.

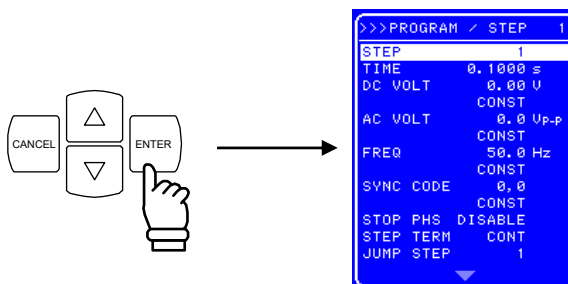

4.5.3 Sequence programming

When PROGRAM is selected in the SEQUENCE screen, the PROGRAM screen is displayed. Sequence programming is performed using the various items displayed on the PROGRAM screen.

The step settings are performed separately for each step.

Changes in waveform through the sequence are possible only through the arbitrary waves (ARB1 to ARB16). Before programming changes in waveform, set the output waveform to arbitrary wave beforehand. To execute a sequence using a sine wave or square wave, set the sine wave or square wave output to on before the start of the sequence. While executing a sequence with a sine wave or square wave, the waveform in that sequence cannot be changed.

For the output method for sine wave, square, and arbitrary waves,  refer to “4.3.6 Setting of waveform”.

The various items displayed on the PROGRAM screen are listed in Table 4-17.

4.5 Sequence Operation

Table 4-17. PROGRAM Screen Item List

Item Name	Item	Operation
STEP	Step No.	Specifies the step number to be set. Setting range: 1 to 255
TIME	Step time	Specifies the duration of the specified step. Setting range: 0.0001 s to 999.9999 s Setting resolution: 0.0001 s
DC VOLT	DC voltage	Sets the DC voltage in the CV mode. Setting range: -115.00 V to 115.00 V Setting resolution: 0.01 V
DC CUR	DC current	Sets the DC current value in the CC mode. Setting range: -40.00 A to 40.00 A (BP4640) -50.00 A to 50.00 A (BP4650) Setting resolution: 0.01 A
-	DC voltage/DC current operation type	Sets the type of transition to the specified DC voltage value and DC current value. The type of transition can be selected from the following three. <ul style="list-style-type: none"> • CONST: Output of the specified value • KEEP: Output of the last value of the previous step • SWEEP: Output started with the last value of the preceding step, with linear sweep outputting the specified value at the end of the step
AC VOLT	Superimposed AC voltage	Sets the superimposed AC voltage value in the CV mode. Setting range: 0.0 Vp-p to 120.0 Vp-p Setting resolution: 0.1 Vp-p
AC CUR	Superimposed AC voltage	Sets the superimposed AC voltage value in the CC mode. Setting range: 0.0 Ap-p to 120.0 Ap-p (BP4640) 0.0 Ap-p to 150.0 Ap-p (BP4650) Setting resolution: 0.1 Ap-p
-	Superimposed AC voltage/superimposed AC current operation type	Sets the type of transition to the specified superimposed AC voltage value and superimposed AC current value. The type of transition can be selected from the following three. <ul style="list-style-type: none"> • CONST: Output of the specified value • KEEP: Output of the last value of the previous step • SWEEP: Output started with the last value of the preceding step, with linear sweep outputting the specified value at the end of the step
FREQ	Frequency	Sets the superimposed AC frequency. Setting range: 1.0 Hz to 100000.0 Hz Setting resolution: 0.1 Hz
-	Frequency operation type	Sets the type of transition to the specified frequency. The type of transition can be selected from the following three. <ul style="list-style-type: none"> • CONST: Output of the specified value • KEEP: Output of the last value of the previous step • SWEEP: Output started with the last value of the preceding step, with linear sweep outputting the specified value at the end of the step

4.5 Sequence Operation

Item Name	Item	Operation
WAVE	Waveform	Selects the arbitrary waveform to be output. Setting range: ARB1 to ARB16
–	Frequency operation type	Selects the type of transition to the specified waveform. The type of transition can be selected from the following three. <ul style="list-style-type: none"> • CONST: Output of the specified waveform • KEEP: Output of the waveform of the previous step
SYNC CODE	Step sync output	Sets the code (2 bits) to be output in sync during step execution. The sequence step transition can be checked by observing the step sync output. Bit 0 is output from pin 5 (DOUT5) of the external control I/O connector, and bit 1 is output from pin 6 (DOUT6). The step sync output can be selected from the following four types. (The code is made up of the values of bits 1 and 0, in this order.) In the Idle status, the code is 0, 0. <ul style="list-style-type: none"> • 0, 0 • 0, 1 • 1, 0 • 1, 1
–	Step sync output operation type	Specifies the output method for step sync output. The output method can be selected from the following two types. <ul style="list-style-type: none"> • CONST: Output of specified code • KEEP: Output of same code as the previous step
STOP PHS	Step end phase	Specifies step end phase (0 deg fixed) enable/disable. The setting can be selected from the following two. <ul style="list-style-type: none"> • DISABLE: Disable • ENABLE: Enable
STEP TERM	Step termination	Sets the operation following step end. The setting can be selected from the following three. <ul style="list-style-type: none"> • CONT: Continue sequence. • STOP: Enter Idle status. • HOLD: Enter Hold status.
JUMP STEP	Jump step	Sets the step number to be jumped to after step end. <ul style="list-style-type: none"> • 0: Jump to next step number. • 1 to 255: Jump to the specified step number.
JUMP NUM	Jump count	Sets the number of times (specified with [JUMP STEP]) that the jump operation is to be performed. <ul style="list-style-type: none"> • 0: Infinite number of jumps • 1 to 999: Specified number of jumps
BRANCH0	Branch step 0	Sets the step number to be jumped to when there is a trigger input. Two types of branch step can be set, BRANCH0 and BRANCH1. As a usage example, by setting the operation to stop following sweep to a low number at the jump destination step, it is possible to stop the operation at a safe point when something has occurred. <ul style="list-style-type: none"> • 0: Disabled branching. • 1 to 255: Jump to the specified step number.
BRANCH1	Branch step 1	

4.5 Sequence Operation

The operation procedures for the various items on the PROGRAM screen are described below.



■ Operation procedure <1>

The settings of the DC voltage/DC current operation type, superimposed AC voltage/superimposed AC voltage operation type, frequency operation type, waveform (WAVE), waveform operation type, step sync output (SYNC CODE), step sync output operation type, step end phase (STEP PHS), and step termination (STEP TERM), are performed with the following procedure.

In the following example, step termination (STEP TERM) is set.

<1> Open the SEQUENCE screen and display the PROGRAM screen.

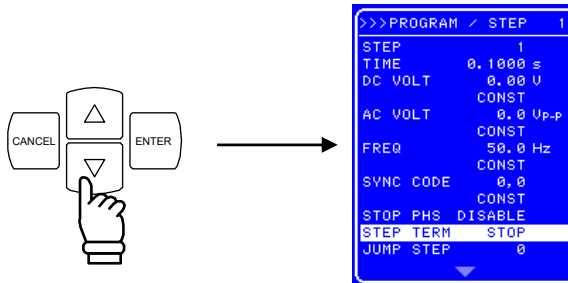

For the procedure up to the display of the PROGRAM screen,  refer to "4.5.2 Setting of sequence".

<2> Press the  and  keys to move the cursor to [STEP TERM].

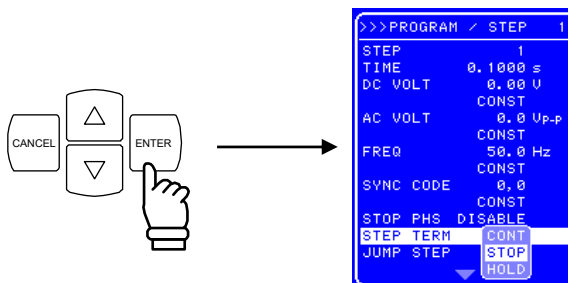

<3> Press the  key to display the Select box.



<4> Press the  and  keys to move the cursor to the operation to be set.

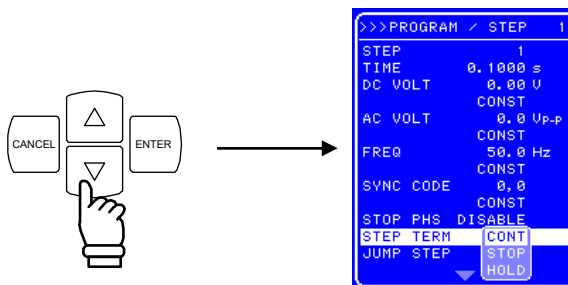

<5> Press the  key to set the operation at step termination.

■ Operation procedure <2>

The settings of the step number (STEP), step time (TIME), DC voltage (DC VOLT), DC current (DC CUR), superimposed AC voltage (AC VOLT), superimposed AC current (AC CUR), frequency (FREQ), jump step (JUMP STEP), jump count (JUMP NUM), and branch (BRANCH0/BRANCH1), are performed with the following procedure.

In the following example, the step time (TIME) is set.

<1> Open the SEQUENCE screen and display the PROGRAM screen.

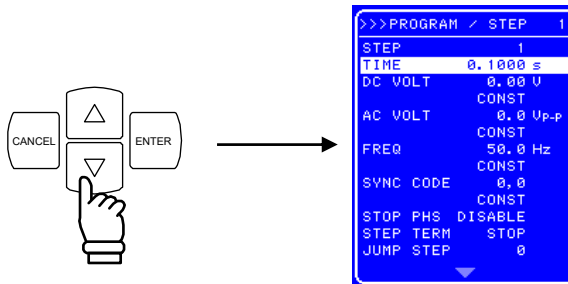

For the procedure up to the display of the PROGRAM screen,  refer to “4.5.2 Setting of sequence”.

<2> Press the  and  key to move the cursor to [TIME].

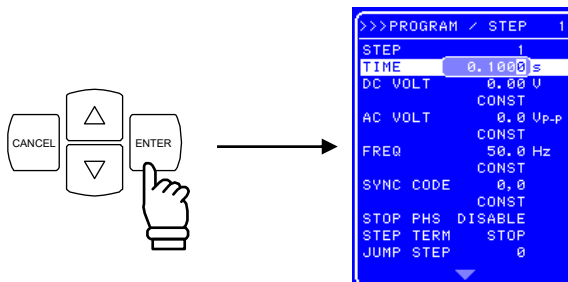

<3> Press the  key to display the Modify box.



<4> Press the  and  keys to move the cursor to the digit to be changed and then turn the [MODIFY] dial to set the desired value.

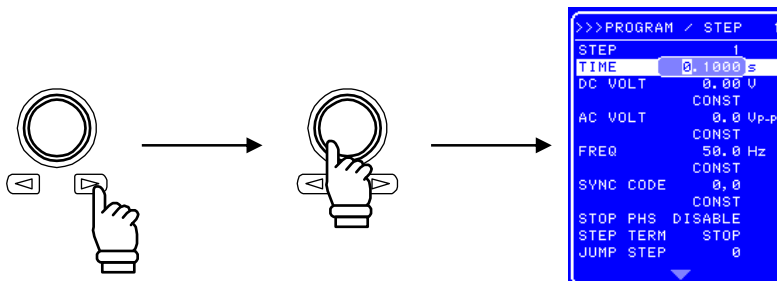

<5> In the same way, set all the digits.

<6> Once all the digits have been set, press the  key. This enables the setting values and completes the step time setting procedure.

4.5.4 Sequence operation control

The sequence operation is controlled with CONTROL in the SEQUENCE screen.

The sequence can start only when the output is on. Therefore, the sequence control select box can be selected only when output is on.

Table 4-18 lists the CONTROL select box items.



Table 4-18. CONTROL Select Box Item List

Select Box Item	Operation
START	Starts sequence operation. The status changes to the Run status.
STOP	Stops sequence operation. The status changes to the Idle status.
HOLD	Pauses sequence operation. The status changes to the Hold status.
BRAN0	Branches to the step specified with [Branch step].
BRAN1	If [Branch step] is not specified, this item is ignored.

The operation procedure is described below.

■ Operation procedure (in case of operation from menu)

<1> Open the SEQUENCE screen and display the CONTROL select box.
 For details on the procedure until display of the CONTROL select box, refer to “4.5.2 Setting of sequence”.

<2> Press the  and  keys to move the cursor to the item indicating the operation to be set.

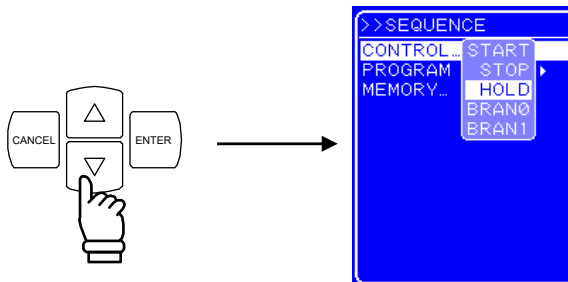

<3> Press the  key to perform the selected operation.

4.5 Sequence Operation

■ Operation procedure (in case of operation using shortcut keys)

Sequence operation control is also possible via the shortcut keys under the operation panel.

The [START], [STOP], and [HOLD] keys located under [SEQUENCE] on the operation panel correspond to the same items in the CONTROL select box. Branch control cannot be performed using the shortcut keys.

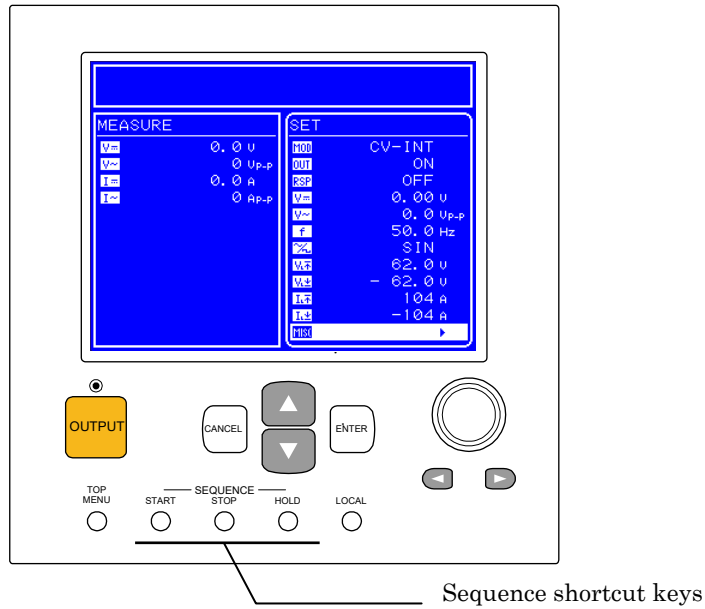

Figure 4-19. Sequence Shortcut Keys

4.5.5 Sequence memory clear

The sequence memory is cleared with MEMORY on the SEQUENCE screen.

Saving to the sequence memory is performed automatically. One sequence can be saved for each of the CV mode and the CC mode.

The procedure is described below.



■ Operation procedure

- <1> Open the SEQUENCE screen and display the MEMORY select box.

For the procedure up to the display of the MEMORY select box,  refer to “4.5.2 Setting of sequence”.

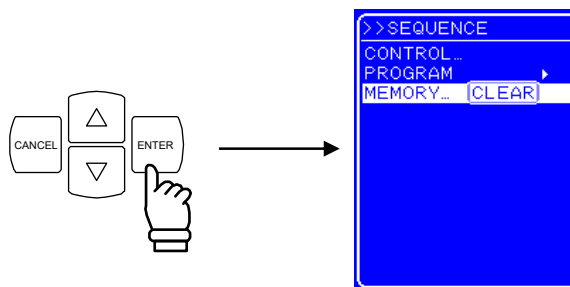
- <2> Press the  key to display the Exe box.



- <3> Pressing the  key when [Clear] is selected clears the sequence memory. When the sequence memory is cleared, the initial value is stored in the memory. ( Refer to “9 INITIAL SETTING LIST”.)

4.5.6 Sequence operation setting example

The procedure for newly setting a sequence operation, taking as an example the sequence shown in Figure 4-20, is described below.

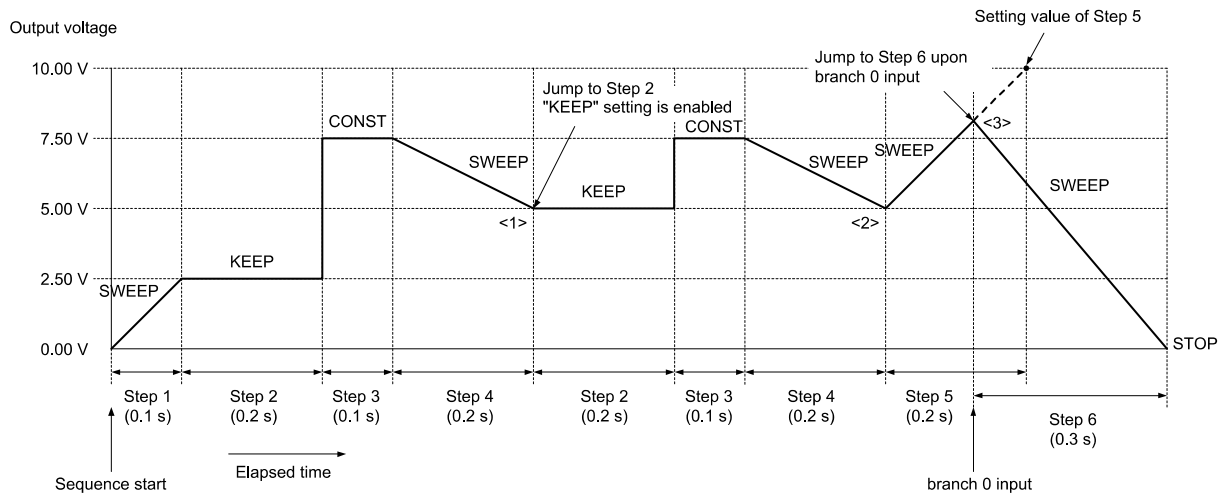

Figure 4-20. Sequence Transition Example (in CV-INT Mode)

Table 4-19. PROGRAM Setting List

Step No.	1	2	3	4	5	6
Step time (TIME)	0.1	0.2	0.1	0.2	0.2	0.3
DC voltage (DC VOLT)	2.50	7.50	7.50	5.00	10.00	0.00
DC voltage operation type	SWEEP	KEEP	CONST	SWEEP	SWEEP	SWEEP
Step termination (STEP TERM)	CONT	CONT	CONT	CONT	CONT	STOP
Jump step (JUMP STEP)	0	0	0	2	0	0
Jump count (JUMP NUM)	1	1	1	1	1	1
Branch 0 (BRANCH0)	0	0	0	0	6	0

Though the DC voltage of step 2 is set to 7.50 V, the output DC voltage will be 2.5 V which is succeeded from the previous step (step 1) because the DC operation type of step 2 is set to KEEP. After executing step 4, the sequence will jump to step 2 because the jump step of step 4 is set to 2 (<1> in Figure 4-20). The output DC voltage will be kept to 5 V coming from the previous step (step 4) because the DC operation type of step 2 is set to KEEP. The jump times of step 4 is set to 1, so the sequence will move to the next step (= step 5) after jumping once and executing step 4 (<2> in Figure 4-20). The step time of step 5 is set to 0.2 s and the branch 0 jump step of step 5 is set to step 6, so the sequence will immediately move to step 6 when the branch 0 is input within the step time (<3> in Figure 4-20).

4.5 Sequence Operation

The operation procedure is described below.

■ Operation procedure via operation panel

<1> Open the PROGRAM screen.

For how to open the PROGRAM screen,  refer to “4.5.2 Setting of sequence”.

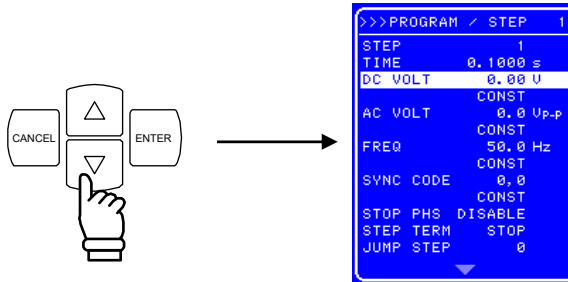

<Step 1 setting>

<2> Press the  key to move the cursor to [DC VOLT].

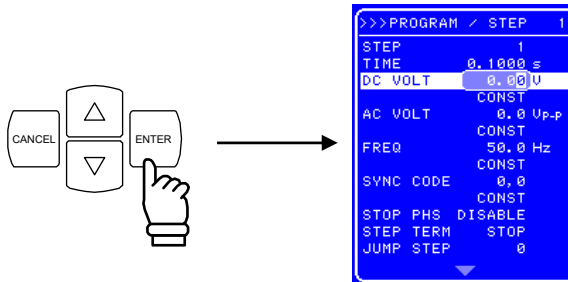

<3> Press the  key to display the Modify box.



<4> Press the  and  keys to move the cursor to the third item from the left and then turn the [MODIFY] dial to set “2”. Next, move the cursor to the fourth item from the left and turn the [MODIFY] dial to set “5” (thus setting “2.5 V”).

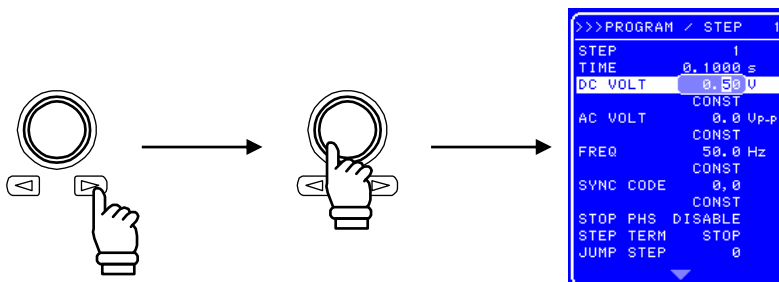

<5> Press the  key to apply the set value.

4.5 Sequence Operation

- <6> Press the  key and move the cursor to the line where “CONST” is displayed (fourth line from the top).

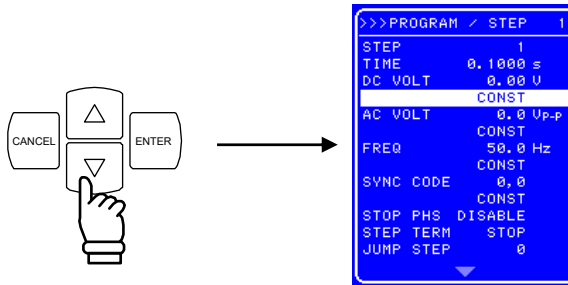

- <7> Press the  key to display the Select box.

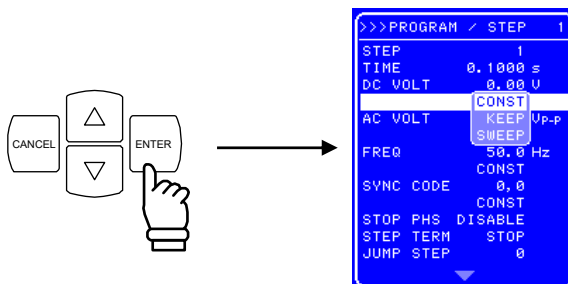

- <8> Press the  key and move the cursor to [SWEEP].

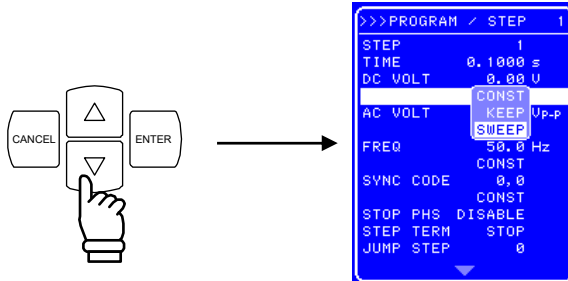

- <9> Press the  key to apply the setting.



The other items are the same as the default setting value and thus need not be changed.

4.5 Sequence Operation

<Step 2 setting>

<10> Press the  and  keys to move the cursor to [STEP].



<11> Press the  key to display the Modify box.

<12> Press the  and  keys to move the cursor to the right-most digit, and then turn the [MODIFY] dial to set “2”.

<13> Press the  key to apply the set value.

<14> Press the  key to move the cursor to [TIME].

<15> Press the  key to display the Modify box.

<16> Press the  and  keys to move the cursor to the fourth digit from the right and then turn the [MODIFY] dial to set “2” (thus setting 0.2 s).

<17> Press the  key to apply the set value.

<18> Using the same operation as in steps <2> to <5>, set DC VOLT = 2.5, and using the same operation as in steps <6> to <9>, set the DC voltage operation type to “KEEP”.



Then go on to set Step 3 and subsequent steps using the same procedure.

4.5.7 Sequence operation execution

When the sequence programming has been completed, start the sequence.
The sequence operation execution procedure is described below.

■ **Operation procedure (in case of operation via the menu)**

<1> Press the  key to return to the top menu. The top menu is displayed as “SET” in the top part of the menu window.

<2> Press the  key to move the cursor to the  icon.

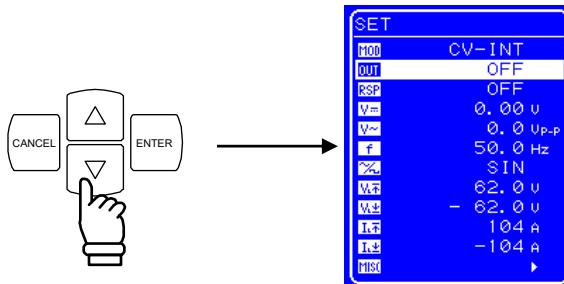

<3> Press the  key to display the Select box.

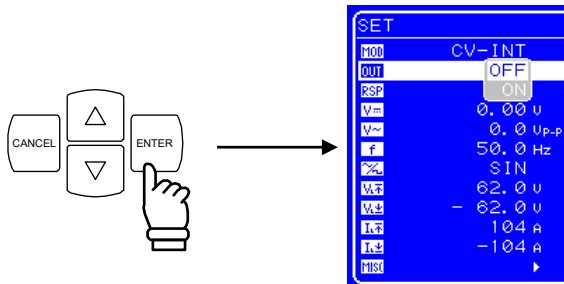

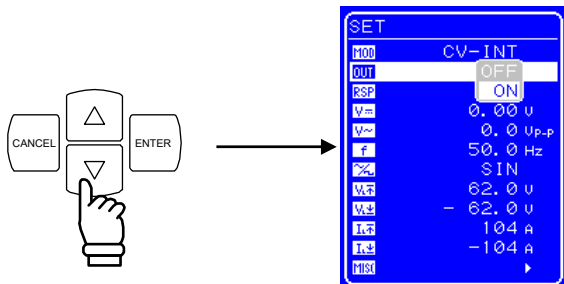

<4> Press the  key to move the cursor to “ON”.



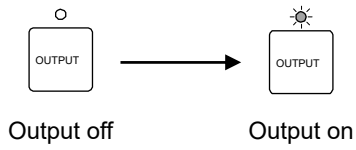

4.5 Sequence Operation

<5> Press the  key to set the output on. The on/off LED goes on.

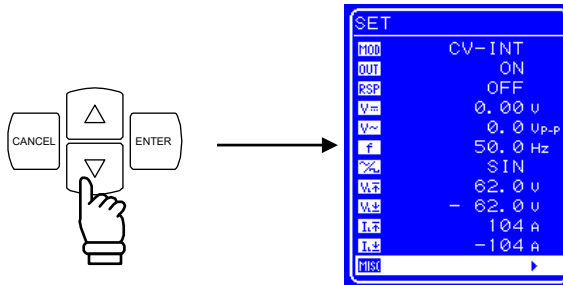

<6> Press the  key to move the cursor to the  icon.



<7> Press the  key to display the MISC screen.

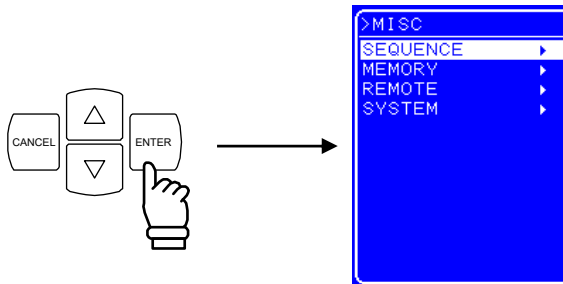

<8> Check that the cursor is positioned over [SEQUENCE], and then press the  key to display the SEQUENCE screen.

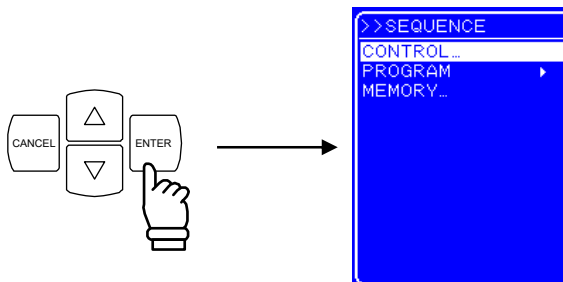

- <9> Check that the cursor is positioned over [CONTROL], then press the  key to display the Select box.

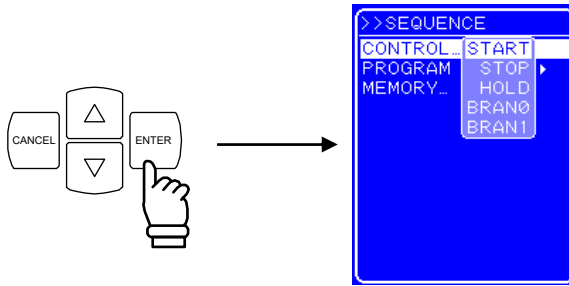

- <10> Select [START] and press the  key to start the sequence.

■ Operation procedure (in case of operation via the keys on the operation panel)

- <1> Press the  key on the operation panel. The output is set to on and the on/off LED goes on.

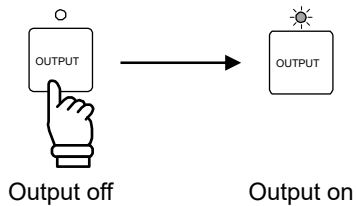

- <2> Press the [START] shortcut key to start the sequence.

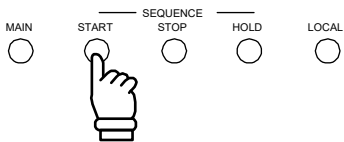

4.5 Sequence Operation

■ Operation after sequence start

When the sequence starts, an icon (**RUN**) indicating that the sequence is currently running is displayed in the Status window. A message box that displays the number of the step currently being executed is also displayed.

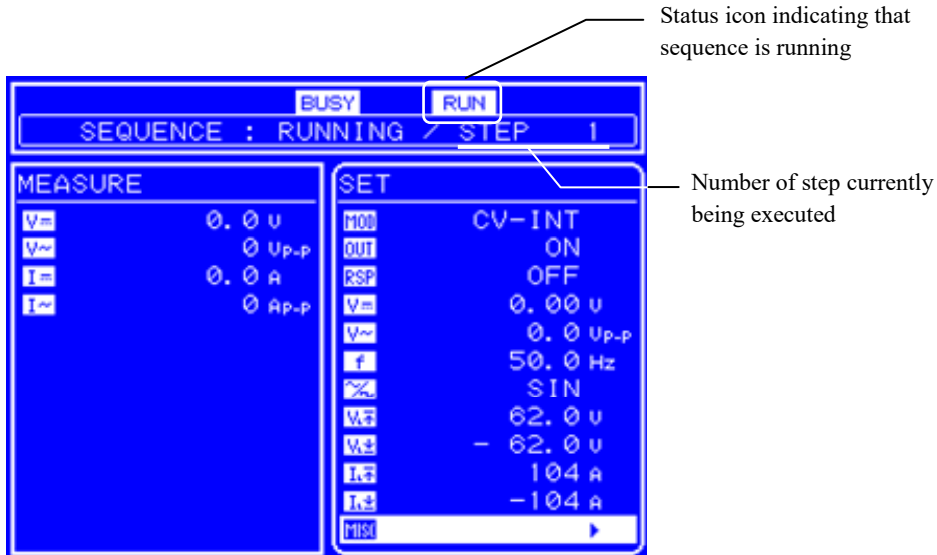

Figure 4-21. LCD Screen When Sequence Is Running

4.6 Control via External Control I/O Connector

Output on/off and sequence execution can be controlled by inputting digital signals to the external control I/O connector. (Detection cycle 2 ms)

External control input must be enabled to perform external control.

(☞ Refer to “4.9.7 Setting of external control input enable/disable”.)

The status of this product can also be monitored by reading the output signal from the external control I/O connector. (Switching cycle 0.1 ms)

The sequence step synchronized output signals are output from the external I/O connector.

(☞ Refer to “2.4.4 Connection to external control I/O connector”.)

After the external signal input level was changed, several tens of ms might be required for the controller to execute a function as a maximum response time. “Output ON/OFF” additionally requires approx. 10ms for a response of a relay device.

Table 4-20 lists the functions of each pin.

Table 4-20. Functions of External Control I/O Connector

Pin No.	Input/Output	Function
1	Output	Outputs the power on/off status. 0 and 1 indicate off and on, respectively.
2	Output	Outputs the output on/off status. 0 and 1 indicate off and on, respectively.
3	Output	Outputs the overload status. 0 and 1 indicate regular operation and abnormal status, respectively.
4	Output	Outputs the software busy status. 0 and 1 indicate regular operation and busy status, respectively.
5	Output	Step sync output 0. Outputs bit 0 of the step sync output.
6	Output	Step sync output 1. Outputs bit 1 of the step sync output.
11	Input	Output off. Upon detection of the falling of the input signal, switches off the output.
12	Input	Output on. Upon detection of the falling of the input signal, switches on the output.
13	Input	Sequence start. Upon detection of the falling of the input signal, starts the sequence.
14	Input	Sequence stop. Upon detection of the falling of the input signal, stops the sequence.
15	Input	Sequence hold. Upon detection of the falling of the input signal, pauses the sequence.
16	Input	Sequence branch trigger 0. Upon detection of the falling of the input signal, jumps to the step specified with BRANCH0.
17	Input	Sequence branch trigger 1. Upon detection of the falling of the input signal, jumps to the step specified with BRANCH1.

4.7 Memory Function

The various settings are battery backed up, so that when the power is applied, the settings when the power was switched off the previous time are restored. However, the response characteristics selection is not saved. Moreover, among the various settings, the basic settings (operation mode, DC, superimposed AC, output limiters) can be recorded to store/recall memories No. 1 to No. 30, and saved settings can be called up for use.

The store/recall memory call operations can be performed only when output is off.

Memory control is performed in the [MEMORY] screen. After selecting an operation in Table 4-21, specify the memory number for that operation in the Select box.

Once the memory number has been specified, the major setting contents recorded in that memory are displayed in the left part of the Menu window.

Table 4-21. MEMORY Screen Menu Item List

Indications in Operation	Operation
STORE...	Saves the setting contents to the specified memory number.
RECALL...	Calls the setting contents of the specified memory number.
CLEAR...	Clears the setting contents of the specified memory number.

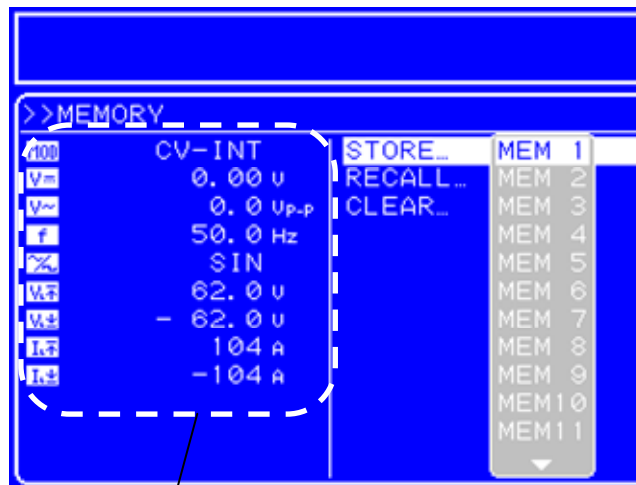



Displays setting contents of selected

Figure 4-22. Memory Contents Display Example



For the setting values after clear is executed, refer to “9 INITIAL SETTING LIST”.

■ Operation procedure

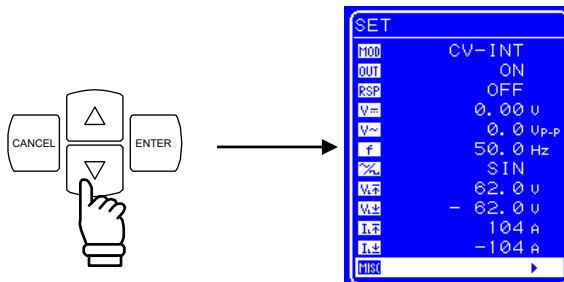
<1> Press the  and  key to move the cursor to the  icon.



<2> Press the  key to display the MISC screen.

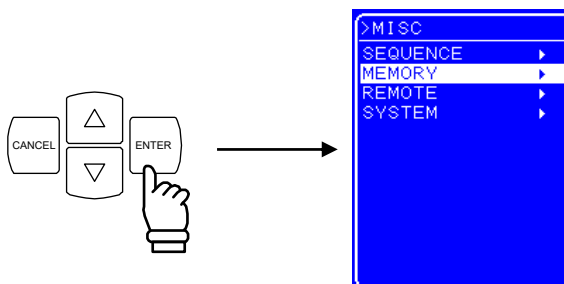

Press the  and  keys to move the cursor to [MEMORY].



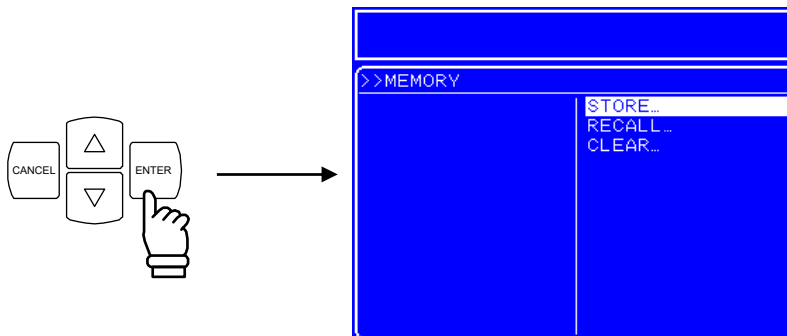

<3> Press the  key to display the MEMORY screen.



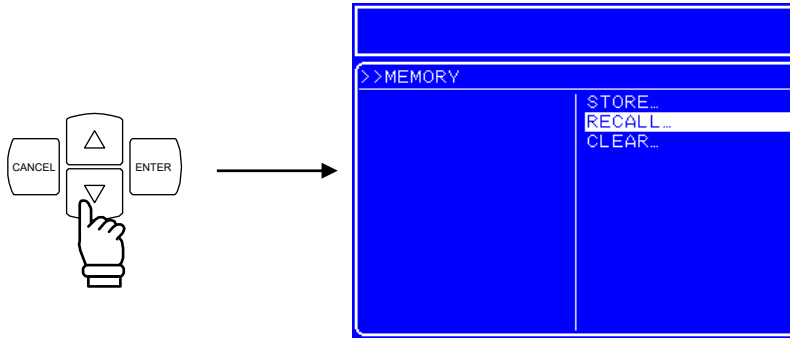

4.7 Memory Function

<4> Press the  and  keys to select the operation to be performed.

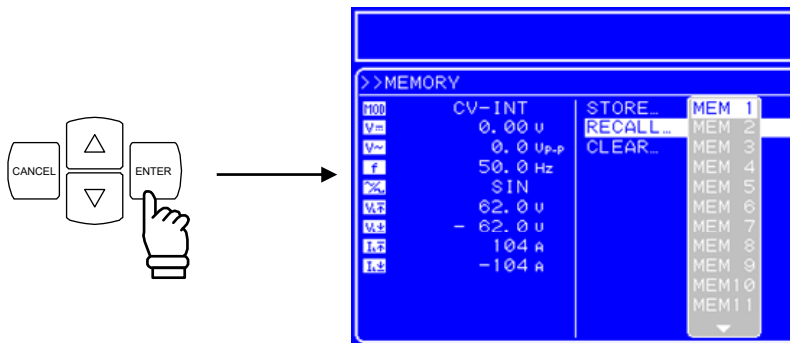

<5> Press the  key to display the Select box.



<6> Press the  and  key to move the cursor to the target memory number.

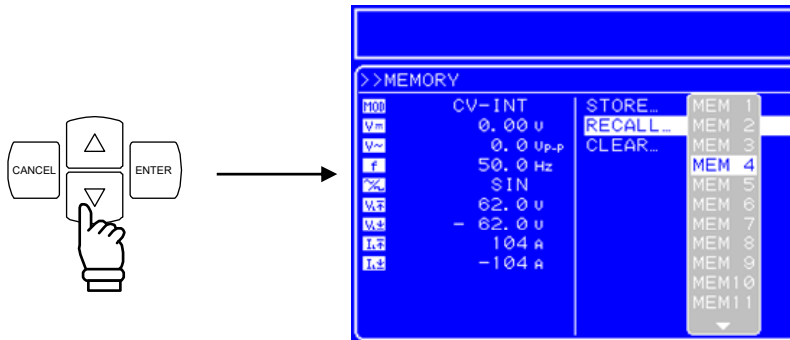



<7> Check the setting contents displayed in the left part of the Menu window, and if they are correct, press the  key to perform the specified operation to that memory number.

4.8 Remote Control

Remote control of this product can be done by transmitting program messages from an external computer connected via the USB interface. (Refer to “5. USB INTERFACE”.)

The various operation modes are entered by transmitting the interface messages listed in Table 4-22 to this product. The current operation mode of this product can be known by looking at the status icon displayed in the Status window on the LCD screen. The status icons are displayed at the same location (top right) on the operation panel.

Table 4-22. Operation Mode List

Icon	Operation Mode	Interface Message
None	Local mode. The various settings can be changed and output on/off can be switched via the operation panel. No status icon is displayed at the top right of the operation window.	GTL
	Remote mode. Control is performed from the external computer connected via the USB interface.	REN
	Local lockout mode. Switching to the local mode via the LOCAL key on the operation panel or via menu operation is prohibited.	LLO



Even in the remote mode, switching to the local mode can be done through key operation from the operation panel. To prohibit operation via the operation panel, set keylock to on (Refer to “4.9 System Menu”), or set the mode to the local lockout mode.

Even in the remote mode (including when local lockout has been specified), output off operation is possible via the [OUTPUT] key.



4.8.1 Switching USB interface

This product is compliant with USB Test and Measurement Class (USBTMC) and USB488. You can switch USB interface.

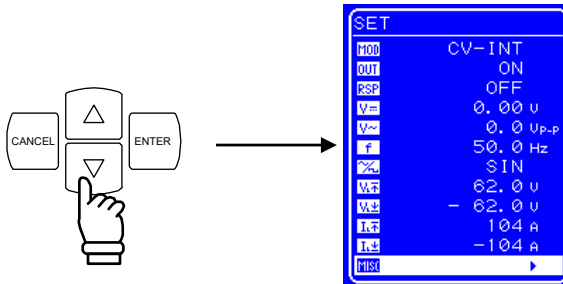

■ **Operation procedure**

<1> Press the  and  keys to move the cursor to the  icon.

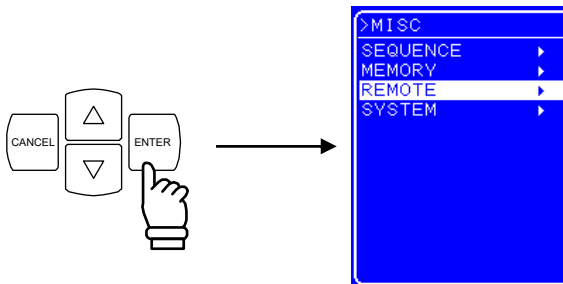

<2> Press the  key to display the MISC screen.
Press the  and  keys to move the cursor to [REMOTE].



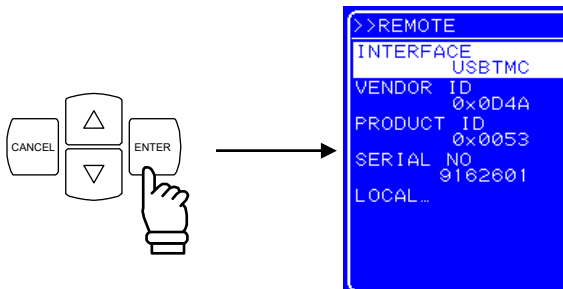

<3> Press the  key to display the REMOTE screen.
Press the  and  keys to move the cursor to [INTERFACE].



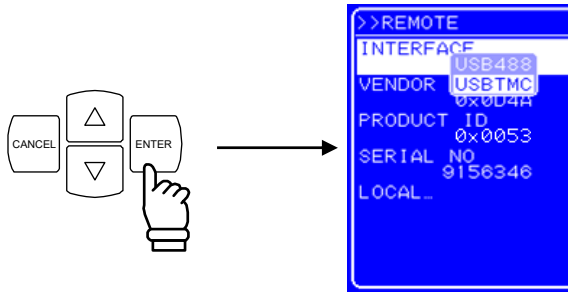

<4> Press the  key to display the Select box.

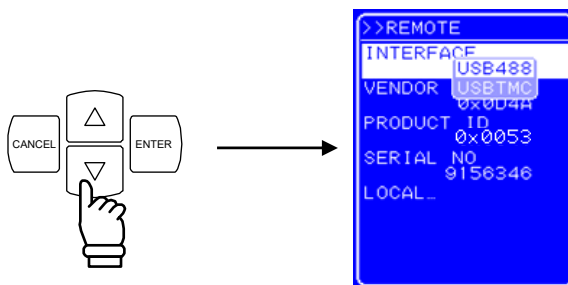

<5> Press the  and  keys to move the cursor to “USB488” for USB488 interface or “USBTMC” for USBTMC interface.



<6> Press the  key to apply the setting, or press the  key to cancel the setting.
Restart the product when you change interface.

----- Comment-----

- Switching USB interface is not valid until you restart the product. Restart the product when you switch USB interface.



4.8.2 USB ID

Used for a system connected with this product through USB, to enable the application identify each source.

4.8.2.1 USBTMC



If you are using USBTMC, USB ID has been assigned to each instrument. It can be checked in “REMOTE” screen.

■ Operation procedure

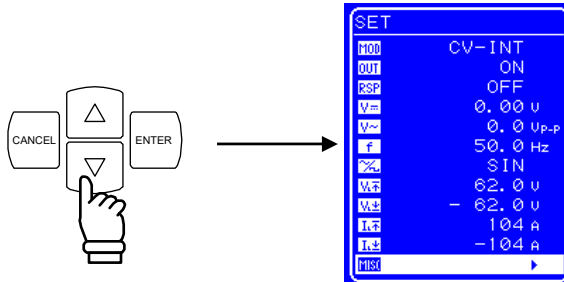
<1> Press the  and  keys to move the cursor to the  icon.



<2> Press the  key to display the MISC screen.

Press the  and  keys to move the cursor to [REMOTE].

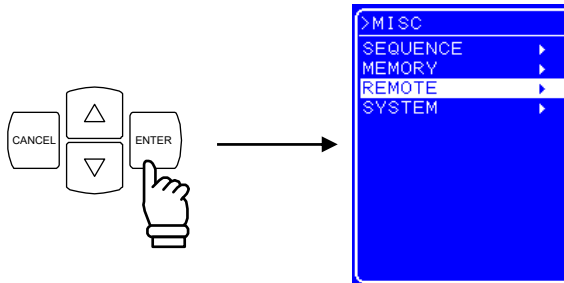

<3> Press the  key to display the REMOTE screen.

If [INTERFACE] is USB488,

Press the  and  keys to select [INTERFACE].

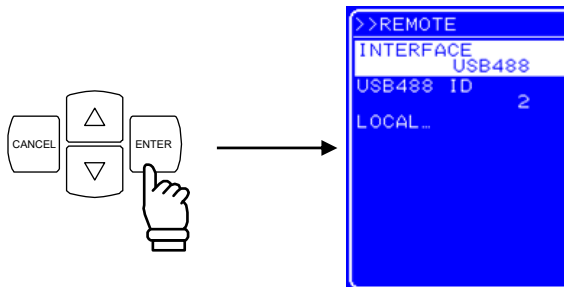

<4> Press the  key to display the Select box.

Press the  and  keys to select [USBTMC].

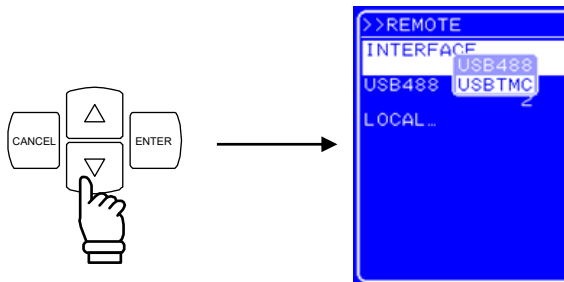

- <5> Press the  key to switch interface to USBTMC. VENDOR ID, PRODUCT ID, and SERIAL NO are displayed.

USB ID format ( refer to “5.1 Preparations Before Usage”)

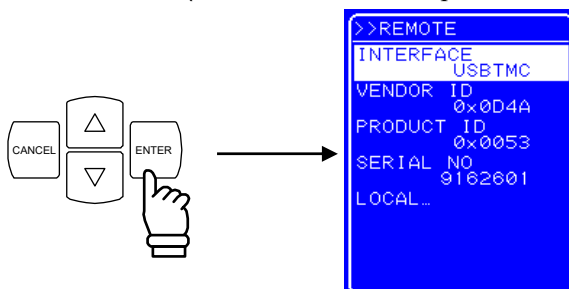



4.8.2.2 USB 488

If you are using USB488, it is necessary to set the USB ID for device identification in advance. The USB ID setting is performed in the [REMOTE] screen.

The USB ID setting range is 1 to 65534.



Set the USB ID after making sure it is correct. If the USB ID is incorrect, control from the computer is not possible. Moreover, if the USB ID is the same as that of another device within the same system, faults may occur in the computer.

■ Operation procedure

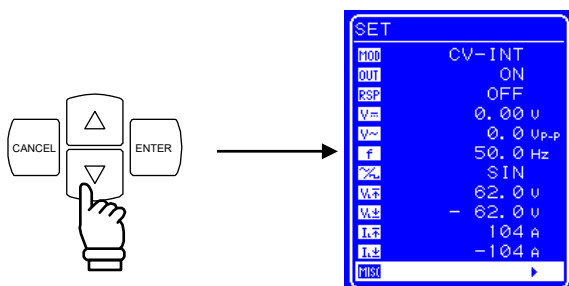

- <1> Press the  and  keys to move the cursor to the  icon.



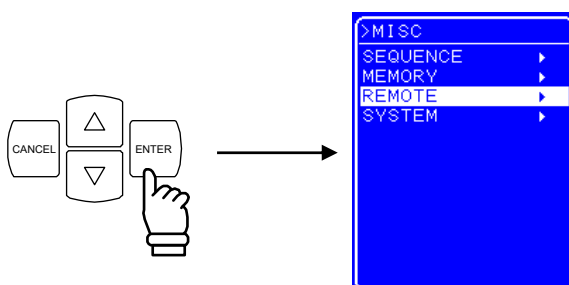

- <2> Press the  key to display the MISC screen.

Press the  and  keys to move the cursor to [REMOTE].



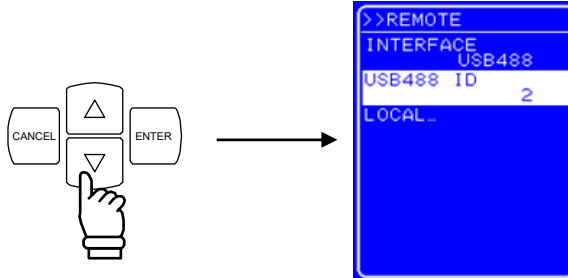

- <3> Press the  key to display the REMOTE screen.
 If [INTERFACE] is USBTMC, switch interface to USB488.
 Press the  and  keys to select [USB488 ID].



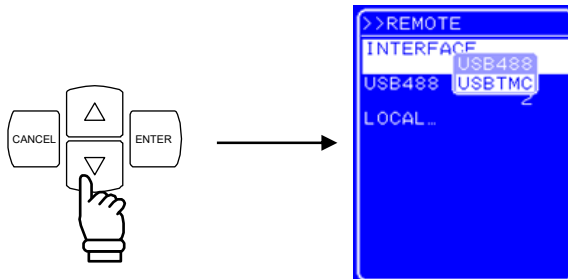

- <4> Press the  key to display the modify button.

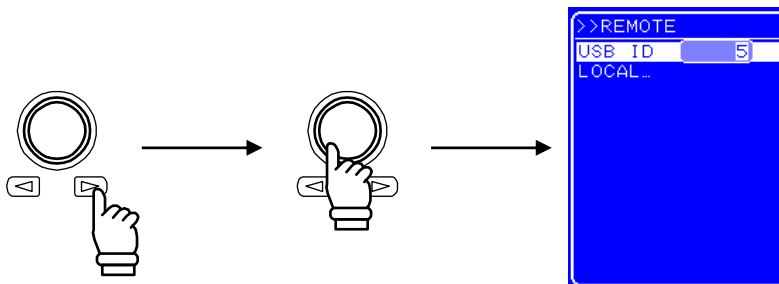

- <5> Press the  and  keys to move the cursor to the digit to be changed and turn the [MODIFY] dial to set the desired value.



- <6> Once all the digits have been set, press the  key to set the USB ID. Or, to cancel the setting and leave the USB ID unchanged, press the .

4.8.3 Switch to local mode

Switching from the remote mode to the local mode can be done in the following three ways.

- Transmission of interface message GTL
- Operation via shortcut keys
- Operation via menu

The operation procedures are described below.

■ Operation procedure (operation via shortcut keys)

Press the [LOCAL] shortcut key to switch to the local mode.

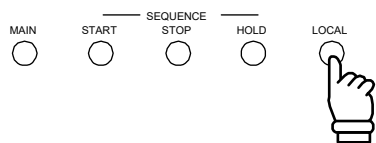



This operation cannot be performed during keylock and local lockout.

During keylock, release keylock before switching to the local mode. (Refer to “4.9.1 Keylock”.)



In local lockout, the **LLO** icon is displayed in the Status window on the LCD screen. If local lockout is enabled, switch to the local mode using an interface message.

■ Operation procedure (operation via operation panel menu)

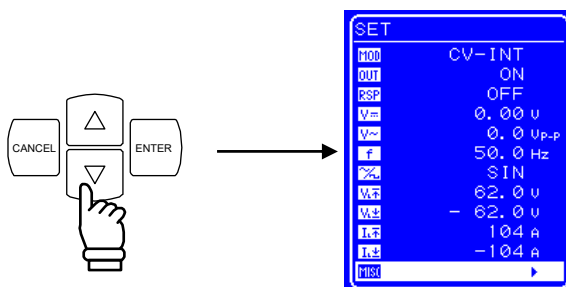
<1> Press the  and  keys to move the cursor to the **MISC** icon.



<2> Press the  key to display the MISC screen.

Press the  and  keys to move the cursor to [REMOTE].

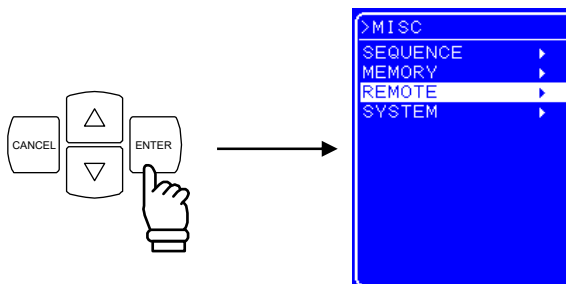

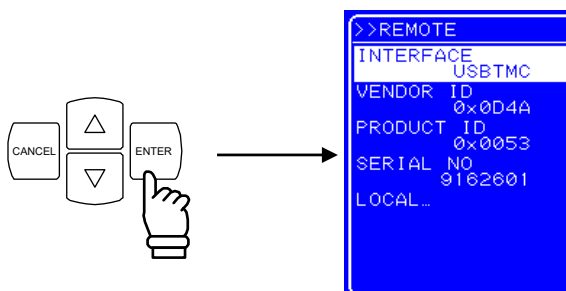

<3> Press the  key to display the REMOTE screen.

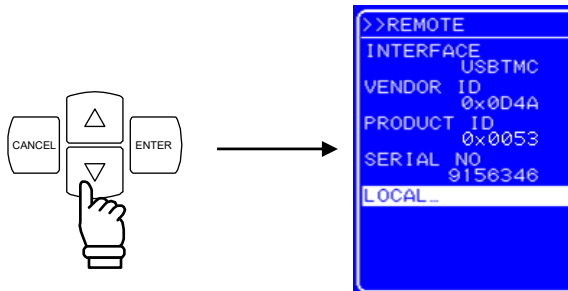

4.8 Remote Control

<4> Press the  and  keys to select [LOCAL...].



<5> Press the  key to display the Exe box.

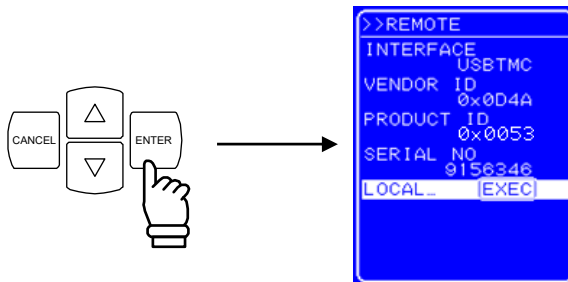

<6> Press the  key when [EXEC] is selected to switch to the local mode.



4.9 System Menu

The system settings for this product are performed via the system menu on the [SYSTEM] screen. Table 4-23 lists the [SYSTEM] screen items.



Table 4-23. System Menu Item List

Menu Item Name	Setting Contents
KEYLOCK	Keylock on/off
BEEP	Beep on/off
CONTRAST	Setting of LCD contrast
COLOR	Setting of LCD display color pattern
FREQ UNIT	Setting of frequency display unit
TIME UNIT	Setting of time display unit
INIT OUT	Setting of output on/off at power-on
INIT RSP	Setting of response calibrator operation on/off at power-on
EXT CONTROL	Setting of external control input enable/disable
RESET...	Execution of reset
INFORMATION	Display of system information

■ [SYSTEM] screen display procedure

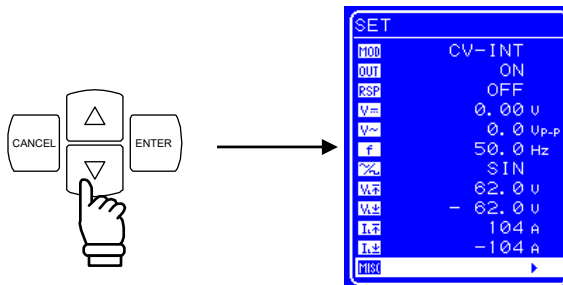
<1> Press the  and  keys to move the cursor to the **MISC** icon.



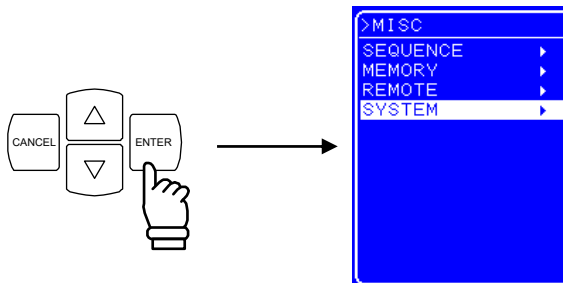

<2> Press the  key to display the MISC screen.
Press the  and  keys to move the cursor to [SYSTEM].

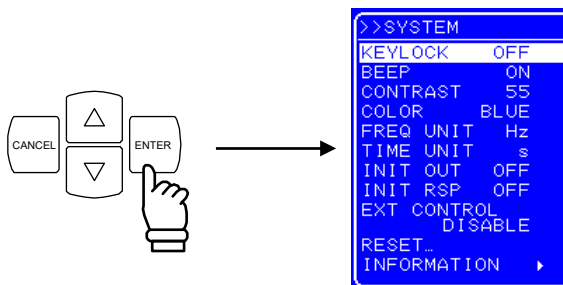

<3> Press the  key to display the SYSTEM screen.





<4> Press the  and  keys to select the operation to be performed.

4.9.1 Keylock

This product has functions to prevent misoperations during operation.

Key operations are disabled at times other than keylock off operation by setting keylock on. However, output off operation through the OUTPUT key is enabled as a workaround during emergencies.

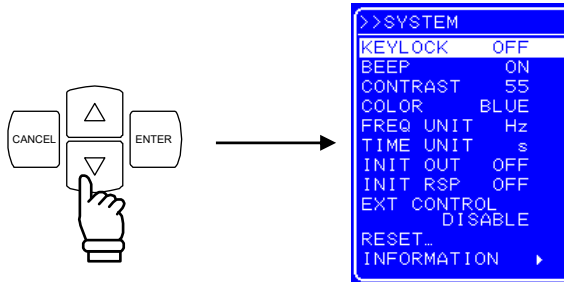

■ Operation procedure

<1> Press the  and  keys to move the cursor to [KEYLOCK].



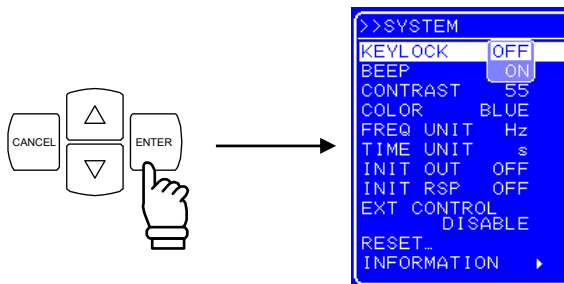

<2> Press the  key to display Select box.

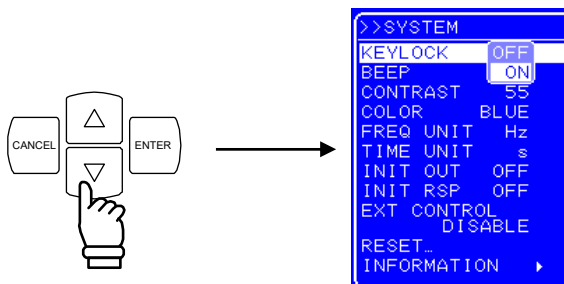

<3> Press the  and  keys to move the cursor to “ON” to switch the keylock to on, or to “OFF” to switch the keylock off.



<4> Press the  key to apply the setting, or press the  key to cancel the setting.

4.9.2 Beep sound

If the beep is switched on, a beep is emitted when a misoperation occurs, when a key is pressed, or when a modify operation is performed. Upon occurrence of overload, a warning sound is emitted regardless of the beep sound setting.

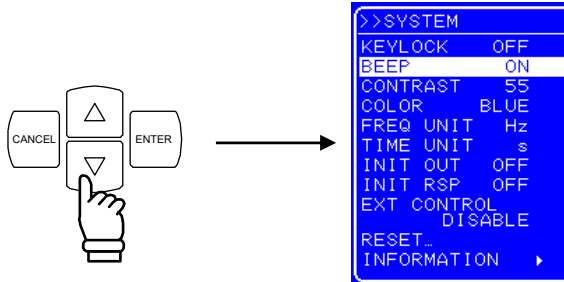

■ Operation procedure

<1> Press the  and  keys to move the cursor to [BEEP].



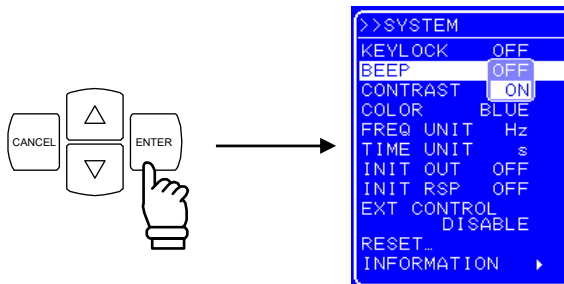

<2> Press the  key to display the Select box.

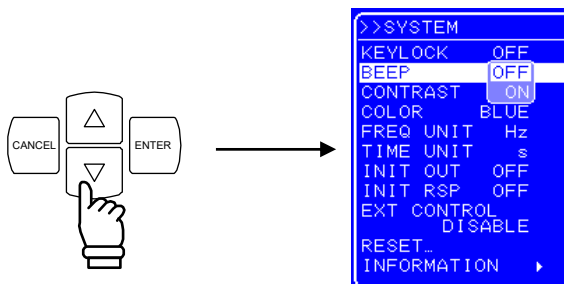

<3> Press the  and  keys to move the cursor to “ON” to switch the beep on, or to “OFF” to switch the beep off.





<4> Press the  key to apply the setting, or press the  key to cancel the setting.

4.9.3 LCD contrast adjustment

The contrast of the LCD screen can be set in 100 steps according to the operating environment. The adjustment entry box can also be displayed by simultaneously pressing the [ENTER] key and the [CANCEL] key. Therefore, even when the contrast is inadequate and the characters on the LCD screen cannot be made out, it is still possible to adjust the contrast. In this case, the digit cursor forcibly goes to the decimal position.

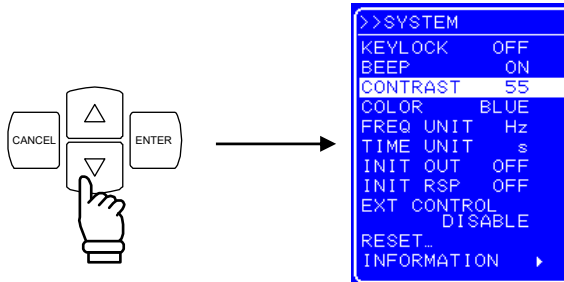

■ Operation procedure

<1> Press the  and  keys to move the cursor to [CONTRAST].



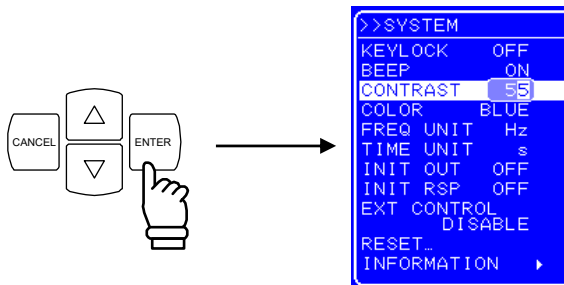

<2> Press the  key to display the Modify box.

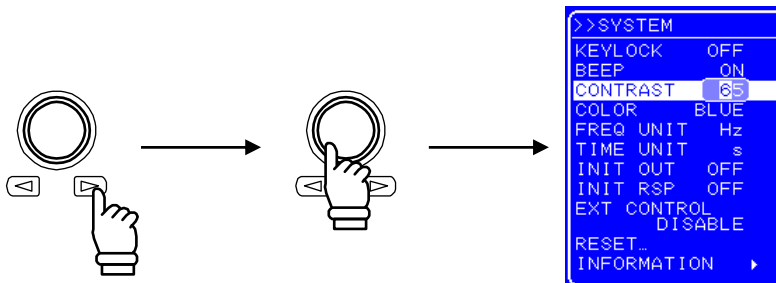

<3> Press the  and  keys to move the cursor to the digit to be modified and turn the MODIFY dial to set the value.





<4> After setting all the digits, press the  key. The LCD contrast is set. Press the  key to cancel the setting.

4.9.4 Setting of LCD display color

The display color of the LCD screen on the operation panel can be selected from blue (white characters against blue background) or white (blue characters against white background).

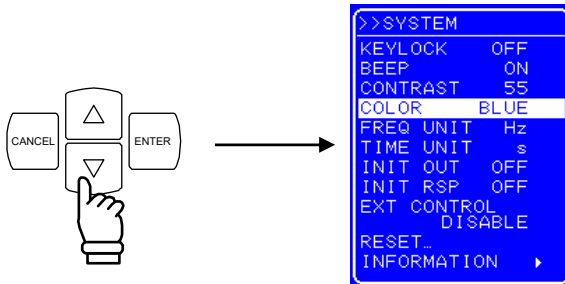

■ **Operation procedure**

<1> Press the  and  keys to move the cursor to [COLOR].



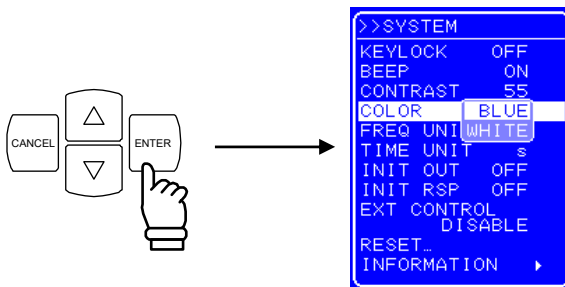

<2> Press the  key to display the Select box.

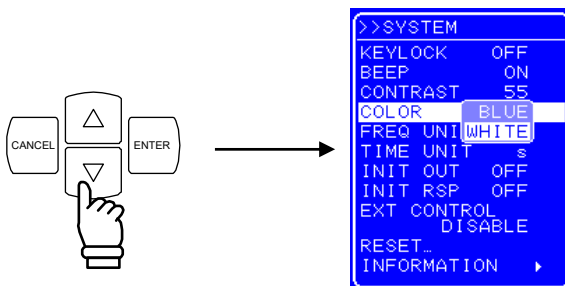

<3> Press the  and  keys to move the cursor to “BLUE” to set a blue screen, or to “WHITE” to set a white screen.





<4> Press the  key to apply the setting, or press the  key to cancel the setting.

4.9.5 Setting of frequency and time units

The unit used when displaying the frequency and time parameters can be specified.

The frequency unit can be selected from Hz and kHz. The time unit can be selected from s and ms.

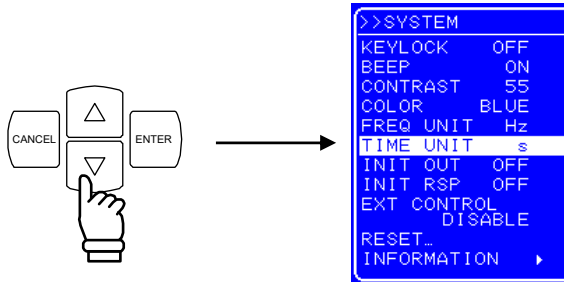

■ **Operation procedure**

- <1> Press the  and  keys to move the cursor to [FREQ UNIT] to set the frequency unit, or to [TIME UNIT] to set the time unit.



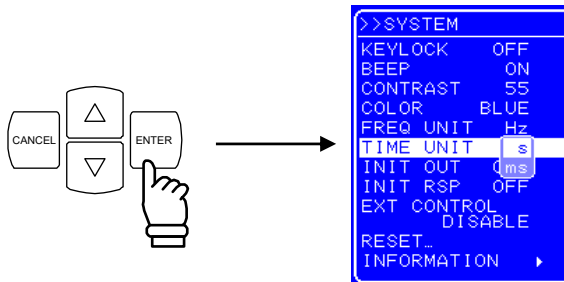

- <2> Press the  key to display the Select box.

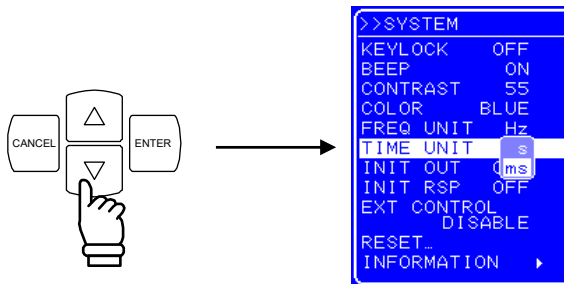

- <3> Press the  and  keys to move the cursor to the unit to be displayed.





- <4> Press the  key to apply the setting, or press the  key to cancel the setting.

4.9.6 Setting of operation of output and response calibrator at power-on

This product allows the output to automatically go on at power-on.

Moreover, the response characteristics can also be set to the adjustment characteristics simultaneously with power-on. (☞ Refer to “4.10.3 Adjustment characteristics”.)

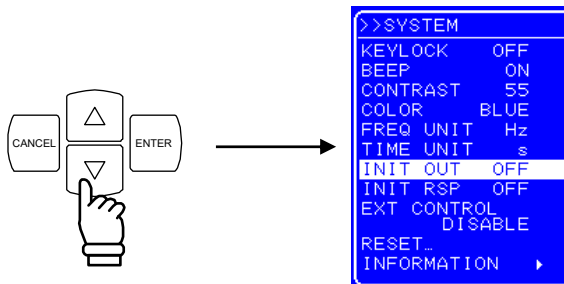

■ Operation procedure

- <1> Press the  and  keys to move the cursor to [INIT OUT] to set the output operation at power-on, or to [INIT RSP] to set the response calibration at power-on.



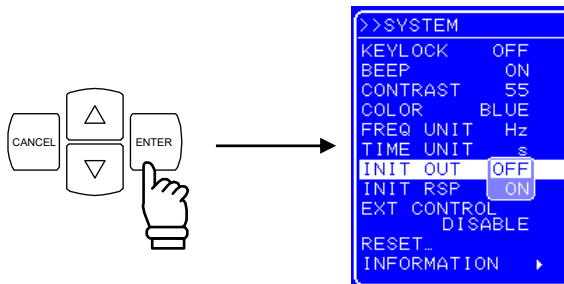

- <2> Press the  key to display the Select box.

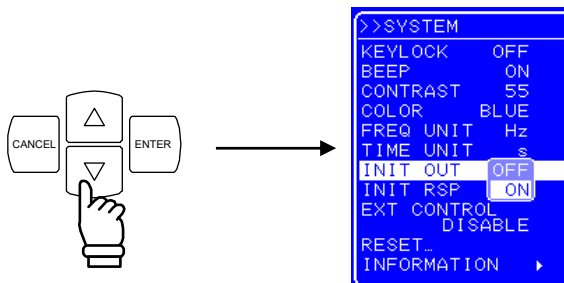

- <3> Press the  and  keys to move the cursor to “ON” or ”OFF” to set “on” or “off”, respectively.





- <4> Press the  key to apply the setting, or press the  key to cancel the setting.

4.9.7 Setting of external control input enable/disable

Set external control input enable/disable. If external control input is disabled, the status of this product is output.

For details on external control input, refer to “2.4.4 Connection to external control input/output connector”.

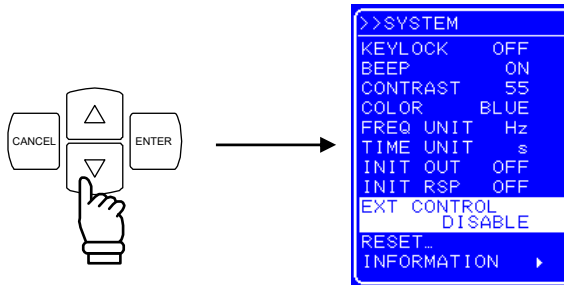

■ Operation procedure

<1> Press the  and  keys to move the cursor to [EXT CONTROL].



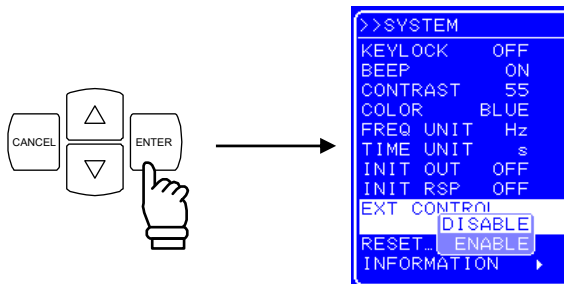

<2> Press the  key to display the Select box.

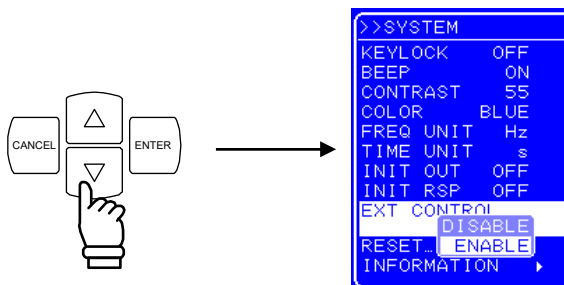

<3> Press the  and  keys to move the cursor to “ENABLE” or to” DISABLE” to respectively enable or disable external control input.



<4> Press the  key to apply the setting, or press the  key to cancel the setting.

4.9.8 Reset function

The reset function returns the basic settings to the factory settings.

This product cannot be reset when output is on. Reset this product in the output off status.

For the setting values after reset,  refer to "9. INITIAL SETTING LIST".

■ Operation procedure

<1> Press the  and  keys to move the cursor to [RESET...].

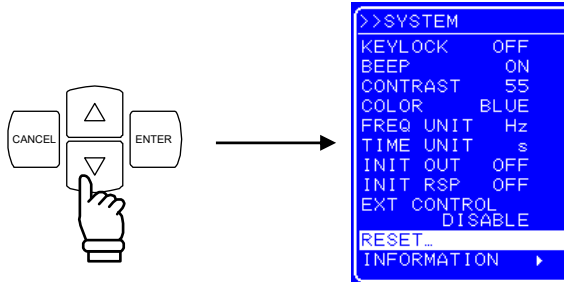

<2> Press the  key to display the Exe box.

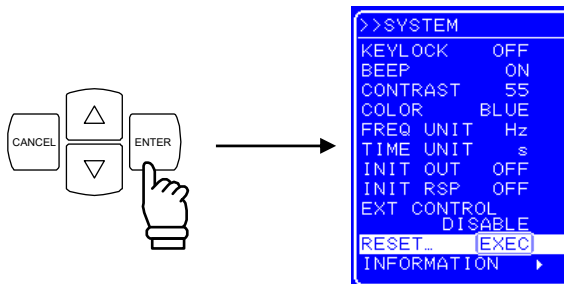

<3> Press the  key while [EXEC] is selected to reset this product.

4.9.9 System information

The firmware version number and other system information can be displayed by selecting [INFORMATION] on the [SYSTEM] screen.

For how to display system information,  refer to "7.4 Version Number Verification Method".

4.10 Response Calibration

4.10.1 Outline

This product has a response calibration function that allows individual optimization of transient response characteristics during square wave output or sudden output changes.

The transient response varies with the load for loads that have complex impedance characteristics such as electromagnetic parts that include inductance (coil components) or capacitance (capacitor components). This product allows the user to adjust the response characteristics according to the load.

The response characteristics of the amplifier can be selected from the following two types.



- Fixed characteristics
- Adjusted characteristics

Switch between fixed and adjusted characteristics in the output off status. Switching in the output on status is not possible.

4.10.2 Fixed characteristics

The fixed characteristics emphasize both wide frequency band characteristics and load stability (during CV: DC to 35 kHz, -3 dB; during CC: DC to 8 kHz, -3 dB).

■ Operation procedure

<1> Press the  and  keys to move the cursor to the **RSP** icon.

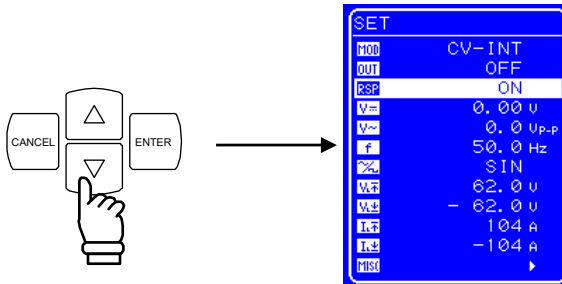

<2> Press the  key to display the Select box.

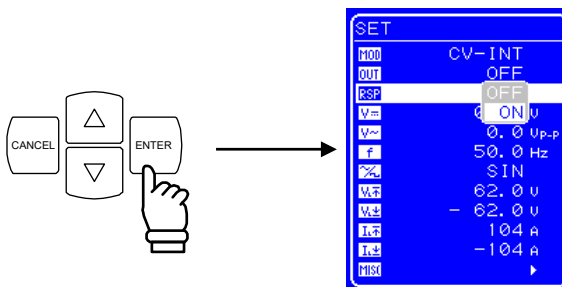

<3> Press the  and  keys to move the cursor to "OFF".

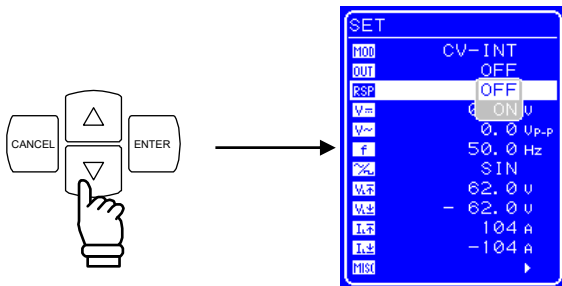

<4> Press the  key to set the response calibrator to off.

4.10.3 Adjustment characteristics

The user can adjust the response characteristics for the load to be actually used.

Through adjustment, it is possible to minimize distortion of the output waveform for a broad range of load conditions including the resistance load as well as inductive load and capacitive load. Adjustment to lower speed and higher speed compared to fixed characteristics is possible.

Adjustment is performed by moving three adjustment knobs corresponding to the time constant, voltage feedback amount, and current feedback amount, while observing the output voltage and output current waveform with an external oscilloscope. The loop characteristics of the amplifier can be changed with these three adjustment knobs, and the output impedance characteristics changed by an equivalent amount. As a result, distortion of output waveform can be minimized for a broad range of load conditions.

■ Operation procedure

- <1> Switch off the output.
- <2> To be able to observe the output voltage waveform and output current waveform, connect an external oscilloscope and the voltage/current monitor terminals (MONITOR OUT) with a BNC cable.
- <3> Adjust each volume of the response calibration (RESPONSE CAL) as shown in step <4>.

T volume: Adjusts the time constant.

V volume: Adjusts the voltage feedback amount.

I volume: Adjusts the current feedback amount.

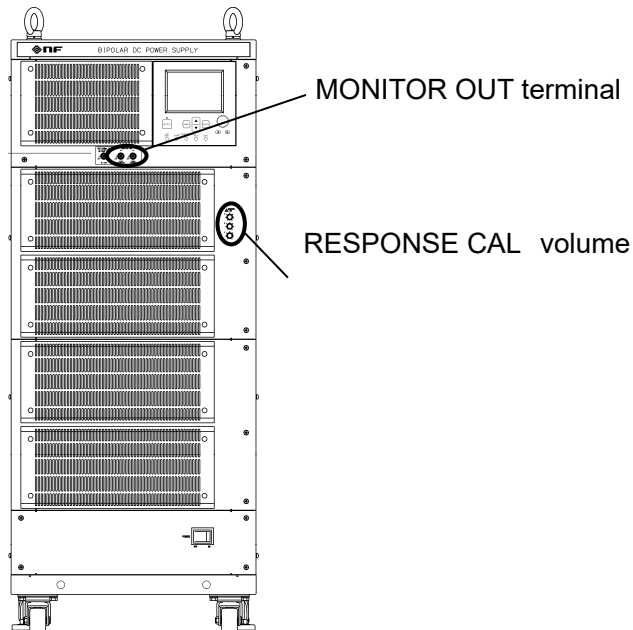

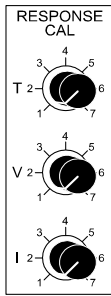

4.10 Response Calibration

- <4> Check that each volume is turned to the left-most position. (A click can be heard when the volume reaches the left-most position.)



- <5> Connect the load.

- <6> Press the  and  keys to move the cursor to the **RSP** icon.

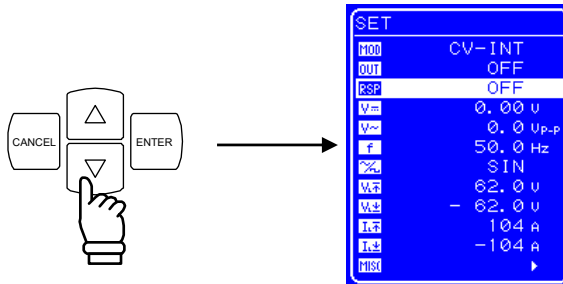

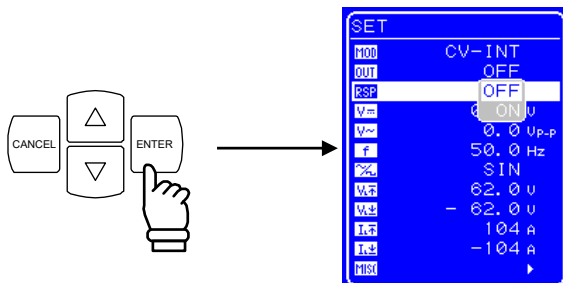

- <7> Press the  key to display the Select box.

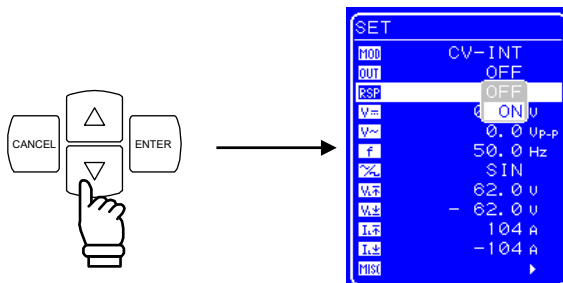

- <8> Press the  and  keys to move the cursor to "ON".



- <9> Press the  key to switch on the response calibrator.
The [Adjusted characteristics] can be selected through the above operation.
- <10> Select SQU (square wave) as the waveform to be output.
For the waveform setting procedure,  refer to “4.3.6 Setting of waveform”.
- <11> Switch on the output.
For the output on switching procedure,  refer to “4.3.2 Output on/off”.
- <12> Adjust the three adjustment knobs towards the rear of the operation panel while observing the waveform with an external oscilloscope.

 **CAUTION**

- The response characteristics can be improved using the adjustment knobs, but an unstable status (oscillation status) may also result depending on how the adjustment is performed according to the load conditions (including no-load). Therefore, when using adjustment characteristics, make sure that the adjustment knobs are set to their slowest and most stable settings on the left (counterclockwise) before using an external oscilloscope for waveform monitoring and before adjustment.
-

4.10.4 Adjustment example

Generally, the capacitive load in the CV mode and the inductive load in the CC mode each form a resonance circuit combined with the output impedance, resulting in a status in which oscillations are easily generated.

Adjustment examples for the CV mode/capacitive load and CC mode/inductive load are presented below.

(1) CV mode/capacitive load

Basically, both T and V are adjusted with their respective adjustment knobs.

While turning the I adjustment knob toward the right lowers the ringing frequency, making it easier to suppress ringing with the V adjustment knob, normally the this product is used with the I adjustment knob turned all the way toward the left.

The operations when each adjustment knob is turned are described below.

- If T adjustment knob is turned to the right
The rise/fall become faster, but the ringing frequency also rises, and its amplitude increases.
- If V adjustment knob is turned to the right
The ringing amplitude is decreased, but the rise/fall become slower.

To make the rise/fall as fast as possible and suppressing ringing, perform adjustments by repeating the following operation.

- <1> Speed up the rise/fall with the T adjustment knob.
- <2> Suppress ringing when it occurs with the V adjustment knob.

(2) CC mode/inductive load

Basically, adjustments can be performed with the T and I adjustment knobs.

Turning the V adjustment knob to the right lowers the ringing frequency and makes it easier to suppress ringing with the I adjustment knob, but normally this product is used with the V adjustment knob turned all the way to the left.

The operations when the adjustment knobs are turned are described below.

- If T adjustment knob is turned to the right
The rise/fall become faster, but the ringing frequency also rises, and its amplitude increases.
- If I adjustment knob is turned to the right
The ringing amplitude is decreased but the rise/fall become slower.

To make the rise/fall as fast as possible and suppress ringing, perform adjustments by repeating the following operations.

- <1> Speed up the rise/fall with the T adjustment knob.
- <2> Suppress ringing when it occurs with the I adjustment knob.

4.11 External Signal Input

This product can also be used as a high-speed bipolar amplifier to which an external signal is input.

It is also possible to perform output by adding the signal of an internal signal source to an external signal input.

To use a signal input from external as the signal source, connect this signal to the external signal input terminal (EXT SIGNAL IN) on the front panel. For this connection, use a coaxial cable with a BNC connector.

For the signal source settings,  refer to “4.3.1 Setting of operation mode”.

The specifications of the external signal input terminal are as follows.

Frequency range:	DC to 200 kHz
Gain:	100× (100 V/1 V), in-phase (CV mode) 40× (40 A/1 V), in-phase (BP4640, CC mode) 50× (50 A/1 V), in-phase (BP4650, CC mode)
Gain accuracy:	±5 % (1 kHz)
Input impedance:	10 kΩ
Non-destructive max. input voltage:	±5V

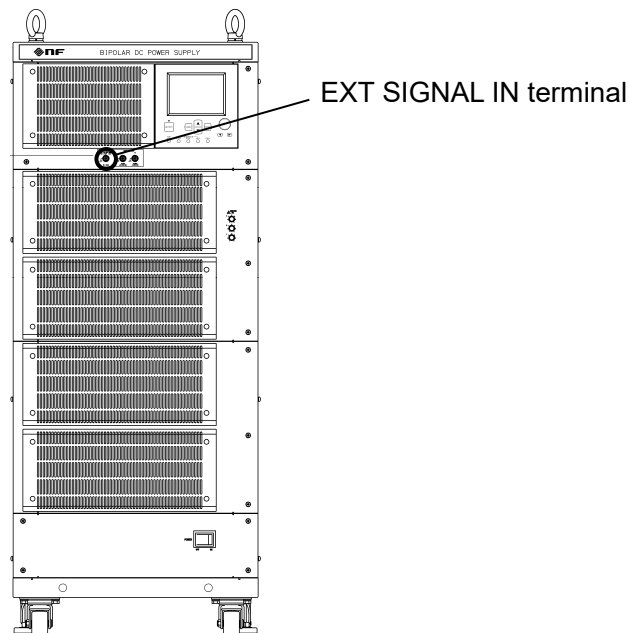

Figure 4-23. EXT SIGNAL IN Terminal

4.12 Voltage and Current Monitor

To monitor the output voltage and output current, use the monitor output terminal (MONITOR OUT) on the front panel. For the connection, use a coaxial cable with a BNC connector. To monitor the output voltage, perform connection to the V_o terminal, and to monitor the output current, perform connection to the I_o terminal.

The specifications of the monitor output terminal are as follows.

■ Output voltage monitor output

Monitor ratio:	1/100 of output voltage (1 V/100 V), in-phase
Monitor accuracy:	± 1.2 V of output voltage (1 M Ω monitor output load impedance)
Frequency characteristics:	DC to 40 kHz: ± 0.5 dB
	40 kHz to 400 kHz: +1 dB, -3 dB (1 kHz reference, 1 M Ω monitor output load impedance)
Output impedance:	50 Ω

■ Output current monitor output

Monitor ratio:	1/40 of output current (1 V/40 A), in-phase (BP4640)
	1/50 of output current (1 V/50 A), in-phase (BP4650)
Monitor accuracy:	± 0.8 A of output current (BP4640)
	± 1 A of output current (BP4650) (1 M Ω monitor output load impedance)
Frequency characteristics:	DC to 20 kHz: ± 0.5 dB
	20 kHz to 200 kHz: +1 dB, -3 dB (1 kHz reference, 1 M Ω monitor output load impedance)
Output impedance:	50 Ω

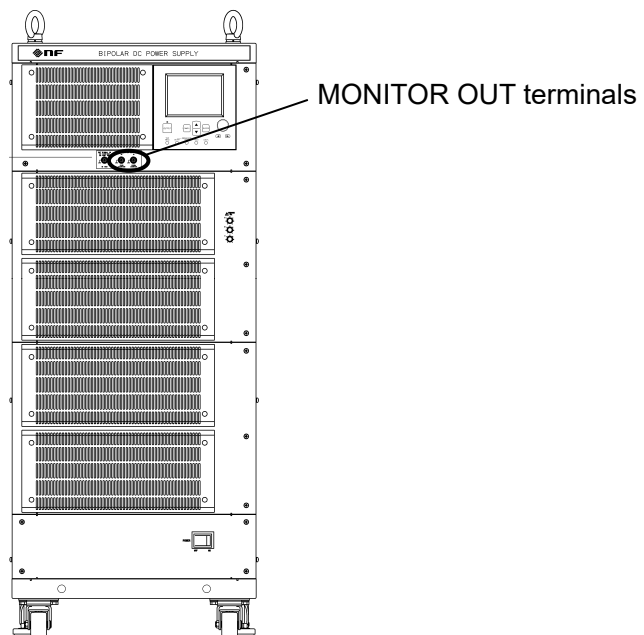

Figure 4-24. MONITOR OUT Terminal

4.13 Measurement Function

This product has a function for measuring the output voltage and output current (DC value and P-P value of each). Since the measured values are displayed in the LCD's measurement value window, the output status can be monitored.

( refer to "8.6 Measurement Function".)



Figure 4-25. Measurement Value Display Example

If measurement over-range occurs, "-----" is displayed in the numerical value field.

5. USB INTERFACE

5.1	Preparations Before Usage	5-2
5.2	Program Message List	5-3
5.3	Explanation of Each Program Message	5-9
5.3.1	Basic settings	5-9
5.3.2	Limiter	5-11
5.3.3	Sequence Related	5-12
5.3.4	Measurement related	5-16
5.3.5	Arbitrary waveform memory	5-16
5.3.6	Store/recall memory	5-17
5.3.7	Status reporting	5-18
5.3.8	Overlap commands	5-20
5.3.9	Other	5-21
5.4	Status Configuration	5-23
5.4.1	Status byte	5-23
5.4.2	Standard event statuses	5-24
5.4.3	Message queue	5-24
5.4.4	Operation statuses	5-25
5.4.5	Warning statuses	5-26
5.4.6	Overload statuses	5-27
5.5	Response to Interface Messages	5-28
5.6	Programming Cautions	5-28

5.1 Preparations Before Usage

This product is provided with remote interfaces and is remote-controllable by a computer. The remote control allows almost all the operations performed on the control panel. In addition, it can read the internal state such as setting values and errors.

Prepare a personal computer equipped with the USB interface when using the USB interface. Install the USBTMC driver or USB488 driver in the computer. Using USBTMC is recommended in this product.

The USB connector is located on the rear panel. USB is an interface that assumes use in a relatively favorable environment. Use of this interface in a place with current fluctuations or high noise level should be avoided. Also, to reduce radiowave leakage in the USB cable, attach the accompanying ferrite core.

■ USBTMC

Normally, USBTMC driver can be executed through the USB as same control as GPIB. This driver is included in the hardware or software products of respective companies that supply the VISA library. The user who does not have the license of VISA library must get it additionally.

VISA: Virtual Instrument software Architecture

- USB ID checking  Refer to “4.8.2.1 USBTMC”.
- The USB ID is represented in the following format.

USB0::[Vendor number]::[Product number]::[Serial number]::INSTR

Vendor number: Fixed to 3402 (0x0D4A)

Product number: Fixed to 83 (0x0052), BP4640

Fixed to 84 (0x0054), BP4650

Serial number: A unique number (serial number) has been set for each product.

■ USB488

- USB ID setting  Refer to “4.8.2.2 USB 488”.
- The USB488 driver can be downloaded from the NF website (<http://www.nfcorp.co.jp/>).
- Set the USB ID after making sure it is correct. If the USB ID is incorrect, control from the computer is not possible. Moreover, if the USB ID is the same as that of another device within the same system, faults may occur in the computer.
- Windows Vista or later is not supported.

5.2 Program Message List

■ Program messages

- The data (programming messages) that can be used for programming is ASCII data (hexadecimal: 20 to 7F), except for arbitrary waveform data blocks. Arbitrary waveform data consists of binary data blocks.
- During reception of program messages by this product, no distinction is made between uppercase and lowercase.
- Response messages are in uppercase.
- When transmitting multiple program messages in succession, insert a “;” (semicolon) as a delimiter between program messages. A space can also be inserted before and after each semicolon for even greater reading ease.
- Insert one or more spaces between the header and parameters of set program messages.

■ Input buffer

- Program messages can be sent in batch up to the input buffer capacity (10,000 characters).
- The transmitted program messages are stored in the input buffer and are then interpreted and executed in the order in which they have been saved.
- If, during interpreting and execution, an illegal program message is discovered, the execution of this and subsequent program messages stops.
- When interpreting and execution are completed, the input buffer is cleared and the next program messages can be input.

The USB program messages of this product are indicated below.

Outline of program messages

 Refer to “Table 5-1 Basic Settings” and “Table 5-9 Other”.

Details (in alphabetical order for each function)

 Refer to “5.3 Explanation of Each Program Message”.

5.2 Program Message List

Table 5-1. Basic Settings

Header	Function		Max. Value	Min. Value	Resolution	Setting	Query
MODE	Function mode	0: CV-INT 1: CV-EXT 2: CV-ADD 3: CC-INT 4: CC-EXT 5: CC-ADD	5	0	1	√	√
OUTP	Output on/off	0: Off 1: On	1	0	1	√	√
RCAL	Response calibrator on/off	0: Off 1: On	1	0	1	√	√
VOLT	DC voltage		115.00	-115.00	0.01	√	√
ACVL	Superimposed AC voltage		120.0	0.0	0.1	√	√
CURR	Output current		40.00 (BP4640) 50.00 (BP4650)	-40.00 (BP4640) -50.00 (BP4650)	0.01	√	√
ACCU	Superimposed AC current		120.0 (BP4640) 150.0 (BP4650)	0.0	0.1	√	√
FREQ	Superimposed AC frequency		100000.0	1.0	0.1	√	√
WAVE	Superimposed AC waveform	0: SIN 1: SQU 2 to 17: ARB1 to ARB16	17	0	1	√	√

Table 5-2. Limiters

Header	Function	Max. Value	Min. Value	Resolution	Setting	Query
LMVP	+ voltage limiter	117.0	7.0	0.1	√	√
LMVM	- voltage limiter	-7.0	-117.0	0.1	√	√
LMCP	+ current limiter	104 (BP4640) 130 (BP4650)	4.0 (BP4640) 5.0 (BP4650)	1	√	√
LMCM	- current limiter	-4.0 (BP4640) -5.0 (BP4650)	-104 (BP4640) -130 (BP4650)	1	√	√

5.2 Program Message List

Table 5-3. Sequence Related

(1/2)

Header	Function	Max. Value	Min. Value	Resolution	Setting	Query
SLEN?	Specifies sequence length	Fixed to 255			–	√
STPN	Specifies step number	255	1	1	√	√
SEXP	Step execution parameters	1st parameter	DC voltage/DC current		√	√
		2nd parameter	DC voltage/DC current operation type 0: CONST/1: KEEP/2: SWEEP		√	√
		3rd parameter	Superimposed AC voltage/ superimposed AC current		√	√
		4th parameter	Superimposed AC voltage/ superimposed AC current operation type 0: CONST/1: KEEP/2: SWEEP		√	√
		5th parameter	Frequency		√	√
		6th parameter	Frequency operation type 0: CONST/1: KEEP/2: SWEEP		√	√
		7th parameter	Waveform 2 to 17: ARB1 to ARB16		√	√
		8th parameter	Waveform operation type 0: CONST/1: KEEP		√	√
		9th parameter	Step sync output 0: (0,0)/1: (0,1)/ 2: (1,0)/3: (1,1)		√	√
		10th parameter	Step sync output operation type 0: CONST/1: KEEP		√	√
STRP	Step transition parameters	1st parameter	Step time mode Fixed to 0		√	√
		2nd parameter	Step time		√	√
		3rd parameter	Step end phase enable/disable 0: Disable/1: Enable		√	√
		4th parameter	Step end phase Fixed to 0 deg		√	√
		5th parameter	Step termination 0: Continue sequence 1: Enter Idle status 2: Enter Hold status		√	√
		6th parameter	Jump step 0: Go to next step number 1 to 255: Step number		√	√

5.2 Program Message List

(2/2)

Header	Function		Max. Value	Min. Value	Resolution	Setting	Query
STRP	Step transition parameters	7th parameter	Jump count 0: Infinite count 1 to 999: Specified count			√	√
		8th parameter	Branch 0 0: Branch disabled 1 to 255: Step number			√	√
		9th parameter	Branch 1 0: Branch disabled 1 to 255: Step number			√	√
SCTL	Sequence control	0: Stop 1: Start 2: Hold 3: Branch 0 4: Branch 1	4	0	1	√	–
SSTS?	Sequence status	0: Idle status 1: Run status 2: Hold status	2	0	1	–	√
SCSN?	Acquires step number during execution		255	–1	1	–	√
SCJN?	Acquires jump count of specified step number		999	–1	1	–	√
SEQM	Sequence memory control	0: Clear	0	0	1	√	–

----- Comment-----

- SCSN? return value –1 indicates that the sequence status is Idle. 0 is an unused number.
- SCJN? return value –1 indicates that the sequence status is Idle.

Table 5-4. Measurement Related

Header	Function	Max. Value	Min. Value	Resolution	Setting	Query
MVLT?	DC voltage measurement value	200.0 [999.9]	–200.0	0.1	–	√
MACV?	AC voltage measurement value	400 [999]	0	1	–	√
MCUR?	DC current measurement value	80.0 (BP4640) 100.0 (BP4650) [99.9 (BP4640)] [999.9 (BP4650)]	–80.0 (BP4640) –100.0 (BP4650)	0.1	–	√
MACC?	AC current measurement value	160 (BP4640) 200 (BP4650) [999]	0	1	–	√

----- Comment-----

- The figures in parentheses [] are the values of response messages when measurement over-range occurs.

5.2 Program Message List

Table 5-5. Arbitrary Waveform Memory

Header	Function	Max. Value	Min. Value	Resolution	Setting	Query
ARBN	Specifies transmit/receive arbitrary waveform memory	17	2	1	√	√
ARBT	Arbitrary waveform transmission/reception	#42048 [Data] Data is in 2's complement format.			√	√
ARBM	Arbitrary waveform memory control	0	0	1	√	–

----- Comment-----

- Partial reading of an arbitrary waveform is not possible.
- When arbitrary waveforms are cleared, sine waves, square waves, and triangular waves are written to ARB1 to ARB8, ARB9 to ARB12, and ARB13 to ARB16, respectively

Table 5-6. Memory

Header	Function	Max. Value	Min. Value	Resolution	Setting	Query
*SAV	Store memory	30	1	1	√	–
*RCL	Recall memory	30	1	1	√	–

Table 5-7. Status Reporting

Header	Function	Max. Value	Min. Value	Resolution	Setting	Query
*STB?	Status byte	255	0	1	–	√
*SRE	SRQ enable register	255	0	1	√	√
*ESR?	Standard event status register	255	0	1	–	√
*ESE	Standard event status enable register	255	0	1	√	√
OPCR?	Operation condition register	32767	0	1	–	√
OPTF	Operation transition filter	32767	0	1	√	√
OPER?	Operation event register	32767	0	1	–	√
OPEE	Operation event enable register	32767	0	1	√	√
WRER?	Warning event register	32767	0	1	–	√
WREE	Warning event enable register	32767	0	1	√	√
OVCR?	Overload condition register	32767	0	1	–	√
OVTF	Overload transition filter	32767	0	1	√	√
OVER?	Overload event register	32767	0	1	–	√
OVEE	Overload event enable register	32767	0	1	√	√
*CLS	Event register content clear	–	–	–	√	–

5.2 Program Message List

Table 5-8. Overlap Command

Header	Function	Max. Value	Min. Value	Resolution	Setting	Query
*OPC	When the device operation had ended, an operation complete message in the standard event status register is output to the device.	-	-	-	√	-
*OPC?	Upon completion of the device operation, 1 is returned.	1	1	1	-	√
*WAI	Until the device operation is completed, the device prohibits further commands or clearing from being executed.	-	-	-	√	-

Table 5-9. Other

Header	Function	Max. Value	Min. Value	Resolution	Setting	Query
BEEP	Beep 0: Off 1: On	1	0	1	√	√
HEAD	Header 0: Off 1: On	1	0	1	√	√
IOUT	Output on/off at power-on 0: Off 1: On	1	0	1	√	√
IRSP	Response calibrator on/off at power-on 0: Off 1: On	1	0	1	√	√
XCTL	External control input enable/disable 0: Disable 1: Enable	1	0	1	√	√
*RST	Device reset	-	-	-	√	-
*TST?	Self test Returns self-diagnosis result at power-on 0: No error Other than 0: Error	444	0	1	-	√
*IDN?	Model name query	NF Corporation, model name, serial number, version number Example of BP4640: NF Corporation, BP4640, 0000001, 3.00			-	√
VERS?	Version number query	Example: 3.00			-	√

5.3 Explanation of Each Program Message

The details of the program messages are described below. Commands are listed in alphabetical order.

5.3.1 Basic settings

■ ACCU/ACCU?

Description: Sets the superimposed AC current.
 Parameter: Current [Ap-p]
 Refer to "Table 5-1 Basic Settings" for setting range.
 Setting example: Setting the superimposed AC current to 20.0 Ap-p
 ACCU 20
 Caution: Settable in units of 0.1 Ap-p.

■ ACVL/ACVL?

Description: Sets the superimposed AC voltage.
 Parameter: Voltage [Vp-p]
 0.0 Vp-p to 120.0 Vp-p
 Setting example: Setting the superimposed AC voltage to 100 Vp-p
 ACVL 100
 Caution: Settable in units of 0.1 Vp-p.

■ CURR/CURR?

Description: Sets the DC current.
 Parameter: Current [A]
 Refer to "Table 5-1 Basic Settings" for setting range.
 Setting example: Setting the DC current to 5.00 A
 CURR 5
 Caution: Settable in units of 0.01 A.

■ FREQ/FREQ?

Description: Sets the superimposed AC frequency.
 Parameter: Frequency [Hz]
 1.0 Hz to 100000.0 Hz
 Setting example: Setting the superimposed AC frequency to 70000 Hz
 FREQ 70000
 Caution: Settable in units of 0.1 Hz.

5.3 Explanation of Each Program Message

■ MODE/MODE?

Description: Sets the operation mode.

Parameter: 0: CV-INT
1: CV-EXT
2: CV-ADD
3: CC-INT
4: CC-EXT
5: CC-ADD

Setting example: Setting the CC-INT mode.
MODE 3

Caution: Setting cannot be performed when the output is on.

■ OUTP/OUTP?

Description: Switches the output on/off.

Parameter: 0: Output off
1: Output on

Setting example: Setting the output on
OUTP 1

■ RCAL/RCAL?

Description: Sets the response calibrator on/off.

Parameter: 0: Response calibrator off
1: Response calibrator on

Setting example: Setting the response calibrator on
RCAL 1

Caution: Setting cannot be performed when the output is on.

■ VOLT/VOLT?

Description: Sets the DC voltage.

Parameter: Voltage [V]
-115.00 V to 115.00 V

Setting example: Setting the output voltage to 90 V
VOLT 90

Caution: Settable in units of 0.01 V.

■ WAVE/WAVE?

Description:	Selects the superimposed current waveform.
Parameter:	0: SIN (sine wave) 1: SQU (square wave) 2 to 17: ARB1 to ARB16 (arbitrary waveform)
Setting example:	Setting the waveform to be output to sine wave WAVE 0
Caution:	Setting cannot be performed when output is on.

5.3.2 Limiter

■ LMCM/LMCM?

Description:	Sets the – current limiter.
Parameter:	Current [A]  Refer to “Table 5-2 Limiters” for setting range.
Setting example:	Setting the – current limiter to –15 A LMCM –15
Caution:	Settable in units of 0.1 A

■ LMCP/LMCP?

Description:	Sets the + current limiter.
Parameter:	Current [A]  Refer to “Table 5-2 Limiters” for setting range.
Setting example:	Setting the + current limiter to 15 A LMCP 15
Caution:	Settable in units of 0.1 A

■ LMVM/LMVM?

Description:	Sets the – voltage limiter.
Parameter:	Voltage [V] –117.0 V to –7.0 V
Setting example:	Setting the – voltage limiter to –100 V LMVM –100
Caution:	Settable in units of 0.1 A

■ LMVP/LMVP?

Description:	Sets the + voltage limiter.
Parameter:	Voltage [V] 7.0 V to 117.0 V
Setting example:	Setting the + voltage limiter to 100 V LMVP 100
Caution:	Settable in units of 0.1 V

5.3.3 Sequence Related

For the sequence settings,  refer to “4.5 Sequence Operation”.

■ SCJN?

Description: Acquires the jump count executed in the step specified with STPN.
Response format: -1 to 999
Caution: -1 indicates the Idle status.

■ SCSN?

Description: Acquires the number of the step under execution.
Response format: -1 to 255
Caution: -1 indicates the Idle status.

■ SCTL

Description: Controls the sequence.
Parameter: 0: Sequence stop
1: Sequence start
2: Sequence hold
3: Sequence branch 0
4: Sequence branch 1
Setting example: Starting a sequence
SCTL 1

■ SEQM

Description: Controls the sequence memory.
Parameter: 0: Clear
Setting example: Clears the sequence memory.
SEQM 0

5.3 Explanation of Each Program Message

■ SEXP/SEXP?

Description: Sets the step execution parameters.

Parameter: 1st parameter: Sets the DC voltage/DC current.
 The DC voltage can be set in units of 0.01 V in the range of -115.00 V to 115.00 V.
 The DC current can be set in units of 0.01 A in the range of Table 5-10.

2nd parameter: Sets the DC voltage/DC current operation type.
 0: CONST/1: KEEP/2: SWEEP

3rd parameter: Sets the superimposed AC voltage/superimposed AC current.
 The AC voltage can be set in units of 0.1 Vp-p in the range of 0.0 Vp-p to 120.0 Vp-p.
 The AC current can be set in units of 0.1 Ap-p in the range of Table 5-10.

4th parameter: Sets the superimposed AC voltage/superimposed AC current operation type.
 0: CONST/1: KEEP/2: SWEEP

5th parameter: Sets the frequency.
 The frequency can be set in units of 0.1 Hz in the range of 1.0 Hz to 100000.0 Hz.

6th parameter: Sets the frequency operation type.
 0: CONST/1: KEEP/2: SWEEP

7th parameter: Sets the waveform.
 2 to 17: ARB1 to ARB16

8th parameter: Sets the waveform operation type.
 0: CONST/1: KEEP

9th parameter: Sets the step sync output.
 0: (0,0)/1: (0,1)/2: (1,0)/3: (1,1)

10th parameter: Sets the step sync output operation type.
 0: CONST/1: KEEP

Setting example: Setting of DC voltage to 10 V, SWEEP, AC voltage to 5 Vp-p superimposed, KEEP, frequency to 20 Hz, KEEP, waveform to ARB3, CONST, step sync output to (0,0), KEEP
 SEXP 10, 2, 5, 1, 20, 1, 4, 0, 0, 1

Table 5-10. DC Current And Superimposed AC Current Setting Ranges

Item	BP4640	BP4650
DC current	-40.00 to 40.00 A	-50.00 to 50.00 A
Superimposed AC current	0.0 to 120.0 Ap-p	0.0 to 150.0 Ap-p

■ SLEN?

Description: Returns the sequence length.

Parameter: 255, fixed

5.3 Explanation of Each Program Message

■ SSTS?

Description: Returns the sequence status.
Response format: 0: Idle status
1: Run status
2: Hold status

■ STPN/STPN?

Description: Specifies the step number.
Parameter: 1 to 255
Setting example: Specifying the step number to be set as 7
STPN 7

■ STRP/STRP?

Description: Sets the step transition parameter.
Parameter: 1st parameter:
0, fixed
2nd parameter: Sets the step time.
The step time is set in units of 1 s.
3rd parameter: Sets step end phase (0 deg) enable/disable.
0: Disable
1: Enable
4th parameter: Sets the step end phase.
0 deg, fixed
5th parameter: Sets the step termination.
0: Continue sequence
1: Enter Idle status
2: Enter Hold status
6th parameter: Sets the jump step number.
0: Jump to the next step number.
1 to 255: Jump to the specified step number.
7th parameter: Sets the jump count.
0: Infinite number of jumps
1 to 999: Specified number of jumps
8th parameter: Sets branch 0.
0: Disable branching.
1 to 255: Jump to the specified step number.
9th parameter: Specifies branch 1.
0: Disable branching.
1 to 255: Jump to the specified step number.
Setting example: Setting of step time to 2 s, step end phase to disable, continuation of sequence and jump to next step at step end, jump count to 1, branch to disable
STRP 0, 2, 0, 0, 0, 0, 1, 0, 0

■ **Example of sequence programming using program messages**

An example of programming that sets the sequence transitions shown in Figure 4-20 using USB program messages is described below.

STPN	1									
SEXP	2.5,	2,	0,	0,	0,	0,	2,	0,	0,	0
STRP	0,	0.1,	0,	0,	0,	0,	0,	0,	0,	0
STPN	2									
SEXP	7.5,	1,	0,	0,	0,	0,	2,	0,	0,	0
STRP	0,	0.2,	0,	0,	0,	0,	0,	0,	0,	0
STPN	3									
SEXP	7.5,	0,	0,	0,	0,	0,	2,	0,	0,	0
STRP	0,	0.1,	0,	0,	0,	0,	0,	0,	0,	0
STPN	4									
SEXP	5,	2,	0,	0,	0,	0,	2,	0,	0,	0
STRP	0,	0.2,	0,	0,	0,	2,	1,	0,	0,	0
STPN	5									
SEXP	10,	2,	0,	0,	0,	0,	2,	0,	0,	0
STRP	0,	0.2,	0,	0,	0,	0,	0,	6,	0,	0
STPN	6									
SEXP	0,	2,	0,	0,	0,	0,	2,	0,	0,	0
STRP	0,	0.3,	0,	0,	1,	0,	0,	0,	0,	0

5.3.4 Measurement related

■ MACC?

Description: Returns the AC current measurement value.
 Response format:  Refer to "Table 5-4 Measurement Related" for response range and response value when measurement over-range occurs.
 Caution: Measurement is performed in units of 0.1 Ap-p.

■ MACV?

Description: Returns the AC voltage measurement value.
 Response format: 0 Vp-p to 400 Vp-p (999 Vp-p is returned in the case of measurement over-range)
 Caution: Measurement is performed in units of 1 Vp-p.

■ MCUR?

Description: Returns the DC current measurement value.
 Response format:  Refer to "Table 5-4 Measurement Related" for response range and response value when measurement over-range occurs.
 Caution: Measurement is performed in units of 0.1 A.

■ MVLT?

Description: Returns to the DC voltage measurement value.
 Response format: -200.0 V to 200.0 V (999.9 V is returned in the case of measurement over-range)
 Caution: Measurement is performed in units of 0.1 V.

5.3.5 Arbitrary waveform memory

The settings performed with ARBM and ARBT are done for the arbitrary waveform memory specified with ARBN. If no specification is made with ARBN, arbitrary waveform memory 2 is used as the default. To control the arbitrary waveform saved to another memory, first specify the memory number with ARBN.

■ ARBM

Description: Controls arbitrary waveform memory.
 Parameter: 0: Clear
 Setting example: Clears arbitrary waveform.
 ARBM 0

■ ARBN/ARBN?

- Description: Specifies the memory number to be transferred and the memory number to be cleared.
- Parameter: 2 to 17
- Setting example: Specifying arbitrary waveform memory 6
ARBN 6
- Caution: An error occurs if 0, 1 is set to the parameter.
Note that since a waveform can also be specified during output, output is performed even during arbitrary waveform rewrite.

■ ARBT/ARBT?

- Description: Transmits/receives arbitrary waveform.
- Parameter: #42048
Data is in the 2's complement format (1024 words, 2048 bytes)
- Setting example: 1) ARBT #42048
2) [higher byte of data 0][lower byte of data 0][higher byte of data 1][lower byte of data 1].....[lower byte of data 1023]
 Refer to "5.6 Programming Cautions".

5.3.6 Store/recall memory

■ *RCL

- Description: Reads the settings.
- Parameter: 1 to 30
- Setting example: Reading the contents of store/recall memory 5
*RCL 5
- Caution: This operation cannot be performed during output on.

■ *SAV

- Description: Saves the settings.
- Parameter: 1 to 30
- Setting example: Saving settings to store/recall memory 5
*SAV 5

5.3.7 Status reporting

■ *CLS

Description: Clears the contents of the event register.

■ *ESE/*ESE?

Description: Standard event status enable register
 Refer to "5.4.2 Standard event statuses".

Parameter: 0 to 255

■ *ESR?

Description: Standard event status register
 Refer to "5.4.2 Standard event statuses".

Response format: 0 to 255

■ OPCR?

Description: Operation condition register
 Refer to "5.4.4 Operation statuses".

Response format: 0 to 32767

■ OPEE/OPEE?

Description: Operation event enable register
 Refer to "5.4.4 Operation statuses".

Parameter: 0 to 32767

■ OPER?

Description: Operation event register
 Refer to "5.4.4 Operation statuses".

Response format: 0 to 32767

■ OPTF/OPTF?

Description: Operation transition filter
 Refer to "5.4.4 Operation statuses".

Parameter: 0 to 32767

5.3 Explanation of Each Program Message

- **OVCR?**
Description: Overload condition register
 Refer to “5.4.6 Overload statuses”.
Response format: 0 to 32767

- **OVEE/OVEE?**
Description: Overload event enable register.
 Refer to “5.4.6 Overload statuses”.
Parameter: 0 to 32767

- **OVER?**
Description: Overload event register
 Refer to “5.4.6 Overload statuses”.
Response format: 0 to 32767

- **OVTF/OVTF?**
Description: Overload transition filter
 Refer to “5.4.6 Overload statuses”.
Parameter: 0 to 32767

- ***SRE/*SRE?**
Description: SRQ enable register
 Refer to “5.4.1 Status byte”.
Parameter: 0 to 255

- ***STB?**
Description: Status byte
 Refer to “5.4.1 Status byte”.
Response format: 0 to 255

- **WREE/WREE?**
Description: Warning event enable register
 Refer to “5.4.5 Warning statuses”.
Parameter: 0 to 32767

- **WRER?**
Description: Warning event register
 Refer to “5.4.5 Warning statuses”.
Response format: 0 to 32767

5.3.8 Overlap commands

Here, device operations refer to the following items.

- MODE: Operation mode switching
- OUTP: Output on/off switching
- *RCL: Setting read
- *RST: Device reset
- SCTL 1: Sequence execution

■ *OPC

Description: Upon completion of the device operation, the operation complete message in the standard event status register is output to the device.

■ *OPC?

Description: Upon completion of the device operation, 1 is returned.

■ *WAI

Description: Until the device operation is completed, the device is prohibited from further executing commands or clearing.

5.3.9 Other

■ BEEP/BEEP?

Description: Sets the beep sound on/off.

Parameter: 0: Off

1: On

Setting example: Setting beep sound on
BEEP 1

■ HEAD/HEAD?

Description: Setting header on/off

Parameter: 0: Off

1: On

Setting example: Setting header on
HEAD 1

■ *IDN?

Description: Queries the model number.

Response format: "NF Corporation, model name, serial number, version number"

Example of BP4640: NF Corporation, BP4640, 0000001, 3.00

■ IOUT/IOUT?

Description: Sets output on/off at power-on.

Parameter: 0: Off

1: On

Setting example: Setting the output on at power-on
IOUT 1

■ IRSP/IRSP?

Description: Sets the response calibrator on/off at power-on.

Parameter: 0: Off

1: On

Setting example: Sets the response calibrator on at power-on.
IRSP 1

5.3 Explanation of Each Program Message

■ *RST

Description: Resets the device.

Caution: This operation cannot be performed while output is on.

 Refer to 9 "INITIAL SETTING LIST".

■ *TST?

Description: Self test. Self-diagnosis result is returned at power-on.

The diagnosis result is returned as 16-bit data. The higher 7 bits, Bit 6, and lower 2 bits are fixed to 0, so judge errors based on the values of bits excluding the above-mentioned.

Response format: 0: No error

Other than 0: Error occurrence

Bit 8: The backup, waveform, and sequence memories have been initialized due to version upgrade.

Bit 7: Not calibrated or initialized without calibration value.

Bit 5: Calibration defect or initialized without calibration value.

Bit 4: Initialized due to sequence memory defect

Bit 3: Initialized due to waveform memory defect

Bit 2: Initialized due to backup memory defect

■ VERS?

Description: Queries the version number.

Response example: 3.00

■ XCTL/XCTL?

Description: Sets external control input enable/disable.

Parameter: 0: Disable

1: Enable

Setting example: Enabling external control input
XCTL 1

5.4 Status Configuration

5.4.1 Status byte

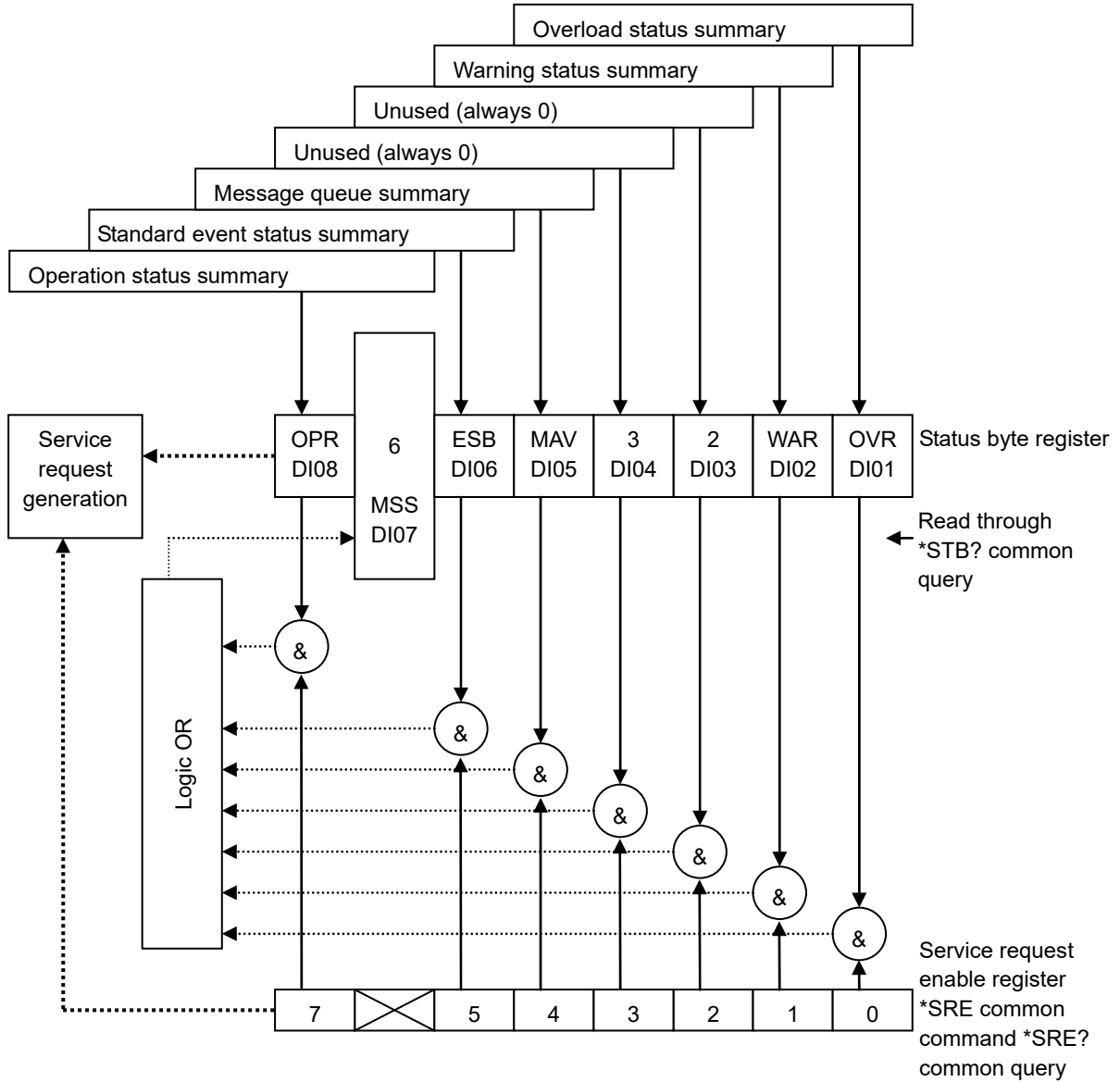

5.4.2 Standard event statuses

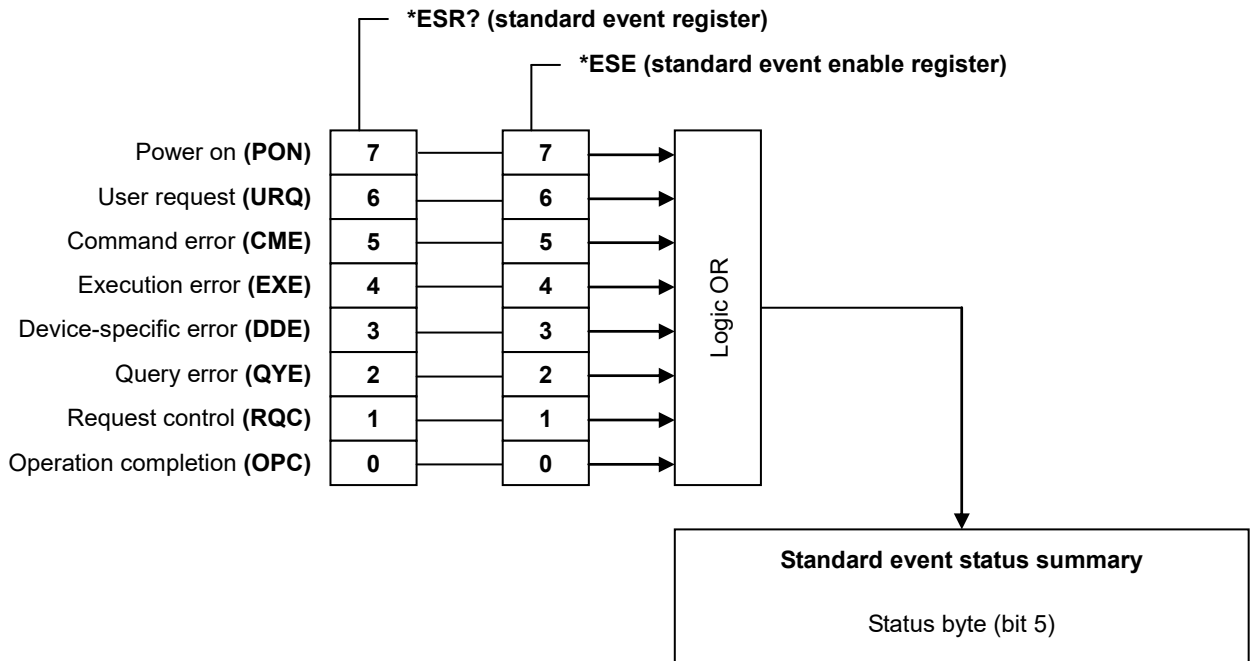

5.4.3 Message queue

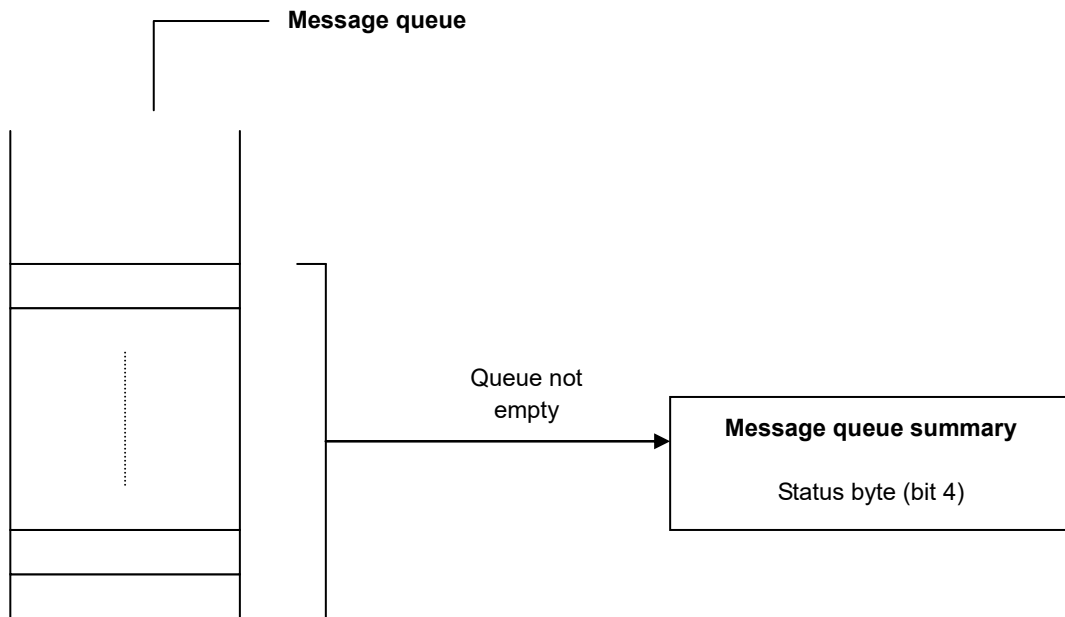

5.4.4 Operation statuses

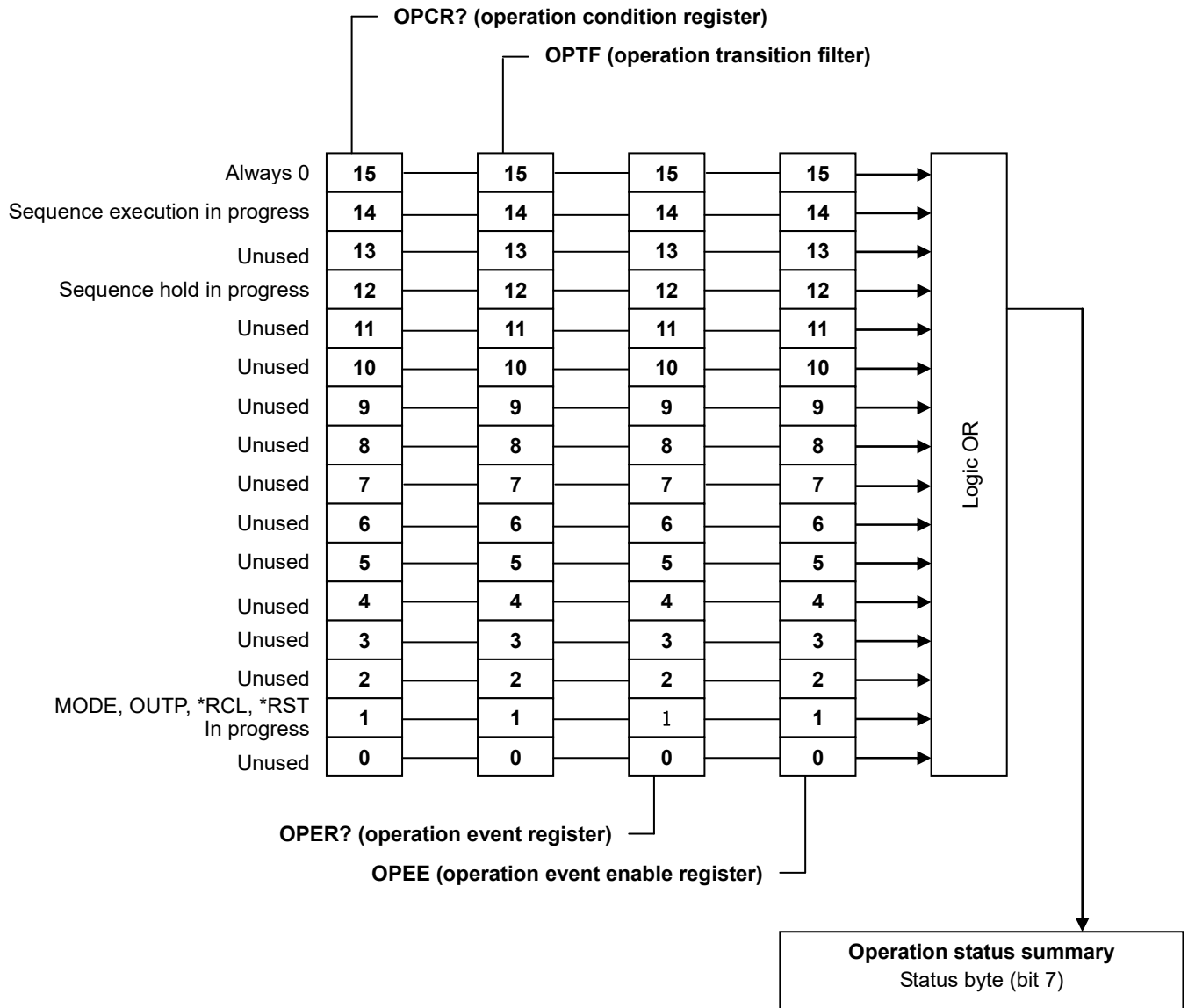

The transition filter converts conditions into events.

If corresponding bit of transition filter is 1:

When the corresponding bit of the condition register changes from 0 to 1, the corresponding bit of the event register is set to 1.

If corresponding bit of transition filter is 0:

When the corresponding bit of the condition register changes from 1 to 0, the corresponding bit of the event register is set to 1.

5.4.5 Warning statuses

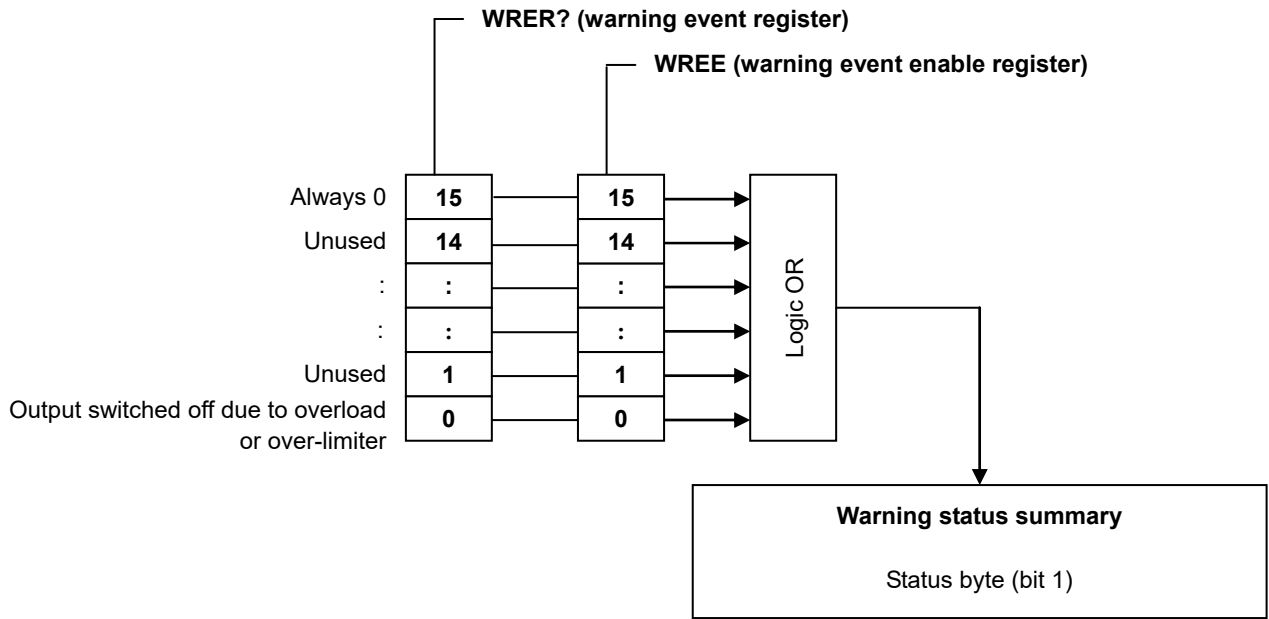

5.4.6 Overload statuses

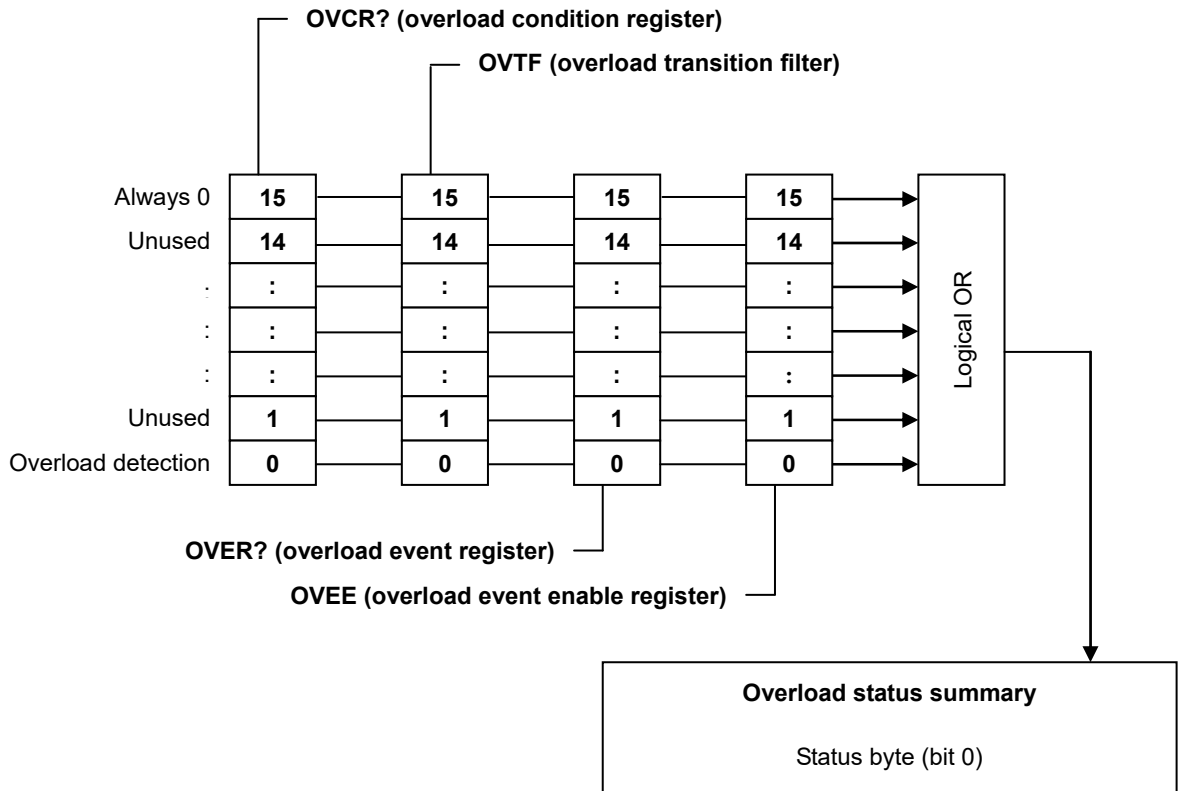

The transition filter converts conditions into events.

If corresponding bit of transition filter is 1:

When the corresponding bit of the condition register changes from 0 to 1, the corresponding bit of the event register is set to 1.

If corresponding bit of transition filter is 0:

When the corresponding bit of the condition register changes from 1 to 0, the corresponding bit of the event register is set to 1.

5.5 Response to Interface Messages

This product allows USB interface control via the interface messages listed in Table 5-10.

Table 5-11. Interface Messages

Interface Message	Response
IFC	Initialize USB interface.
SDC	Clear USB I/O buffer, clear status, and clear RQS bit.
REN	Set this product to remote status.
GTL	Set this product to local status.
LLO	Set this product to local lockout status. Disable [LOCAL] key on operation panel. Perform lock so that switching to local mode via the operation panel is not performed.

5.6 Programming Cautions

■ Arbitrary waveform data

The arbitrary waveform data is the binary data part, and therefore must be transmitted separately from the command part of the preceding ASCII program message. The arbitrary waveform data must be transferred as 1024 words (2048 bytes). If a different amount of data is transferred, an error will occur or the correct waveform will not be output.

Example: 1) ARBT #42048
 2) [higher byte of data 0][lower byte of data 0][higher byte of data 1]
 [lower byte of data 1] [lower byte of data 1023]

6. TROUBLESHOOTING

6.1	Error Messages	6-2
6.1.1	Error at power-on	6-2
6.1.2	Protective function related errors	6-3
6.1.3	Errors during operation	6-5
6.1.4	Warning display	6-6
6.2	Protective Functions	6-7
6.2.1	Overload	6-8
6.2.2	Over-limiter	6-8
6.3	When Suspecting a Fault	6-9

6.1 Error Messages

This product runs a self-diagnosis at power-on, and if an anomaly is detected, an error message is displayed. An error message is also displayed when an incorrect setting or operation is performed.

The contents and cause of the error message, as well as the required handling, are listed below.

6.1.1 Error at power-on

This product performs the following fault diagnoses at power-on.

If an error occurs, “NG” is displayed on the system check screen.

Table 6-1 lists the diagnosis items and the required handlings in case of fault detection.

Table 6-1. Self-Diagnosis Errors

Fault Diagnosis Item	Fault Contents	Operation at Fault Detection & Required Handling
ROM CHECK	ROM sum-check	Product failure may have occurred. Contact NF Corporation or an NF Corporation sales representative.
RAM READ/WRITE CHECK	RAM read and write check	The operation stops at this point and the error remains displayed until the power is switched off.
BACKUP MEMORY CHECK	Backup memory sum-check	This product starts after memory initialization is completed. (Refer to “9. INITIAL SETTING LIST”.) In such cases, the characteristics of the backup battery may be degraded. (Refer to “7.6 Backup Battery”.)
WAVE MEMORY CHECK	Waveform memory sum-check	
SEQUENCE MEMORY CHECK	Sequence memory sum-check	
VERSION CHECK	Version number check	
CALIBRATION MEMORY CHECK	Calibration value memory sum-check	This product starts after calibration value memory initialization has been completed. In this case, this product starts up without calibration values, and therefore the prescribed performance cannot be obtained. Since there may be defective parts, contact NF Corporation or an NF Corporation sales representative.

■ Examples of screen displays in case of fault detection during self-diagnosis

```

ROM CHECK ..... OK
RAM READ/WRITE CHECK ..... OK
BACKUP MEMORY CHECK ..... OK
WAVE MEMORY CHECK ..... OK
SEQUENCE MEMORY CHECK ..... OK
CALIBRATION MEMORY CHECK ..... NG ..... INITIALIZED
VERSION CHECK ..... NG ..... INITIALIZED
    
```

6.1.2 Protective function related errors

Table 6-2 lists the error messages displayed when protective function related errors occur. Error messages are displayed in the message display window upon detection in the case of a power failure, or the next time this product is powered on in all other cases. If an error message appears, press the [ENTER] or [CANCEL] key. (☞ Refer to “6.2 Protective Functions”.)

Table 6-2. Protective Function Related Errors

Error Message	Protection Item	Operation and Required Handling
Emergency shutdown. caused by: OVERLOAD	Overload detection anomaly	The message is displayed the next time the power is switched on. Regardless of whether or not the output is off, the fact that overload was detected is displayed. Upon detection of this anomaly, contact NF Corporation or an NF Corporation sales representative.
Emergency shutdown. caused by: DCPS FAILURE	DCPS anomaly	The message is displayed the next time the power is switched on. The message indicates that the fact that the DCPS output voltage range exceeded the prescribed range was detected. Upon detection of this anomaly, contact NF Corporation or an NF Corporation sales representative.
Emergency shutdown. caused by: OVER TEMPERATURE	Overheating anomaly	The message is displayed the next time the power is switched on. This message indicates that overheating of the radiator was detected. Check if the air filter is clogged.
Emergency stop. caused by: POWER FAILURE	Power failure	The message is displayed upon detection of power failure. It indicates that an instantaneous power interruption has been detected.
Emergency shutdown. caused by: BOOT FAILURE	Boot failure	The message is displayed the next time the power is switched on. It indicates that the line monitoring circuit has not started up normally. Upon detection of this anomaly, contact NF Corporation or an NF Corporation sales representative.
Emergency shutdown. caused by: RESET FAILURE	Reset anomaly	The message is displayed the next time the power is switched on. It indicates that the power-on reset circuit has not started up normally. Upon detection of this anomaly, contact NF Corporation or an NF Corporation sales representative.
Emergency shutdown. caused by: FRONT PANEL FAILURE	Operation panel anomaly	The message is displayed the next time the power is switched on. It indicates that an anomaly has been detected in the communication data exchanged with the operation panel. Upon detection of this anomaly, contact NF Corporation or an NF Corporation sales representative.



Figure 6-1. Protective Function Related Error Display Examples

6.1.3 Errors during operation

Table 6-3 lists error messages that are displayed when errors occur during operation. Error messages are displayed in the message box. The message box automatically closes 1.5 seconds later.

Table 6-3. Errors during Operation

Error Message	Error Description
INVALID WITH OUTPUT ON	Setting (execution) is not possible while output is on.
INVALID WITH OUTPUT OFF	Setting (execution) is not possible while output is off.
INVALID IN THIS MODE	Setting (execution) is not possible because the mode is incorrect.
INVALID WITH THIS WAVE	Setting (execution) is not possible with this waveform.
UNDER BUSY STATE	Setting (execution) is not possible because of busy status.
UNDER REMOTE STATE	Setting (execution) is not possible because of remote status.
UNDER LOCAL STATE	Setting (execution) is not possible because of local status.
UNDER LOCAL LOCK OUT	Setting (execution) is not possible because of local lockout.
UNDER KEYLOCK	Setting (execution) is not possible because of keylock.
OUT OF LIMITER	Output cannot be switched on because of over-limiter.
OUT OF RANGE	USB parameter range check error
EXECUTION ERROR	Execution error other than above
OUT OF MEASURE RANGE	Measurement out of range
COMMAND ERROR	USB interface command error
QUERY ERROR	USB interface query error

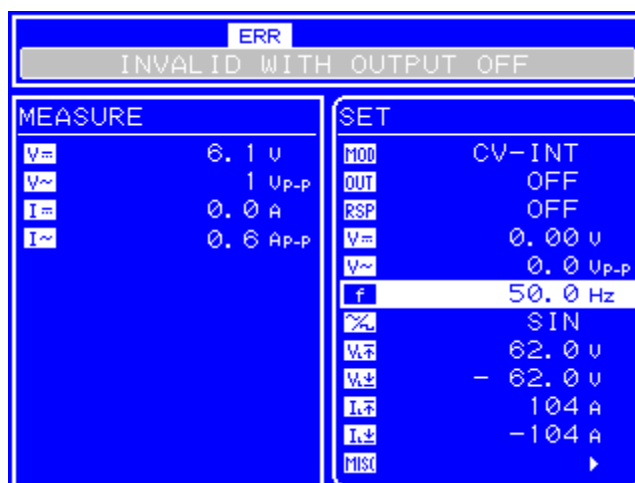

Figure 6-2. Examples of Error Display During Operation

6.1.4 Warning display

If output becomes off due to overload or over-limiter, one of the warnings listed in Table 6-4 is displayed.

During panel operation, this warning is displayed in the message display window. If a warning is displayed, press the [ENTER] key or the [CANCEL] key.

During remote operation, the warning is displayed in the message box. The message box automatically closes after 1.5 seconds. (Refer to “6.2 Protective Functions”.)

Table 6-4. Warning Display

Message	Description
Output off. caused by: OVERLOAD	Indicates output off due to overload (during panel operation)
OUTPUT OFF CAUSED BY OVERLOAD	Indicates output off due to overload (during remote operation)
Output off. caused by: OVER LIMITER	Indicates output off due to over-limiter (during panel operation)
OUTPUT OFF CAUSED BY OVER LIMITER	Indicates output off due to over-limiter (during remote operation)



Figure 6-3. Warning Display Example

6.2 Protective Functions





This product has the protective functions listed in Table 6-5. If the power is interrupted by a protective function at a time other than power failure, the cause is recorded and an error message (described in  “6.1.2 Protective function related errors”) is displayed the next time this product powers on.

Table 6-5. Protective Functions

Protection Type	Action upon Detection		Action upon Detection
	Output off	Power off	
Overload protection (overload)	Yes	Not while overload continues	The output is switched off at the same time that a beep is emitted if the overload continues for 10 seconds after detection. OVERLOAD is displayed while overload continues.  refer to “6.2.1 Overload”)
Overload detection anomaly	Yes	Yes	The power is switched off upon detection of overload, regardless of whether the output is off. An overload protection error message is displayed the next time this product is powered on.  refer to “6.1.2 Protective function related errors”)
DCPS anomaly	Yes	Yes	The output and the power are switched off upon detection. A DCPS anomaly error message is displayed the next time this product is powered on.
Overheat protection	Yes	Yes	The output and the power are switched off upon detection. An overload protection error message is displayed the next time this product is powered on.
Power failure	Yes	No	The power is switched off upon detection. An error message is displayed and the system is locked upon detection of a power failure.
Measurement protection (over-limiter)	Yes	No	The output is switched off while a beep is emitted if the DC current voltage measurement value exceeds the voltage limiter range. If the above conditions are exceeded during output operation, the output cannot be switched on.  refer to “6.2.2 Over-limiter”)
Boot anomaly	Yes	Yes	The output and power are switched off upon detection. A reset anomaly error message is displayed the next time this product is powered on.
Reset anomaly	Yes	Yes	The output and power are switched off upon detection. A reset anomaly error message is displayed the next time this product is powered on.
Operation panel anomaly	Yes	Yes	The output and power are switched off upon detection. An operation panel anomaly error message is displayed the next time this product is powered on.

6.2.1 Overload

This product detects overload in the following cases.

- The output voltage exceeds the limiter value
- The output current exceeds the limiter value
- The internal power loss (average, momentary) is excessive
- The DCPS average output power is excessive

Upon detection of overload, this product displays the overload status, as follows.

- Upon detection of overload, the  icon flashes and a beep is emitted.
- If the overload continues for 10 seconds after overload detection, a beep is emitted and the output is switched off. An error message, listed in Table 6-4, is also displayed.
- If the overload further continues, the power switch is forced off. After this product is powered back on, an error message, listed in Table 6-2, is displayed.

6.2.2 Over-limiter

If the DC output voltage measurement value exceeds the maximum value of the set voltage limiter range or is 3 V or more under the minimum value, over-limiter is judged to have occurred. Upon detection of over-limiter, this product displays the over-limiter status as follows.

For how to set the limiter values,  refer to “4.4 Setting of Limiters”.

- A beep is emitted and the output is switched off. An error message, listed in Table 6-4, is also displayed.
- If the limiter values are exceeded during output on operation, the output cannot be switched on. In this case, the status icon () is displayed and an error message, listed in Table 6-3, is displayed.

6.3 When Suspecting a Fault

When suspecting a fault, perform the following handling. If this fails to achieve recovery, contact NF Corporation or an NF Corporation sales representative.

Problem	Possible Cause	Handling
The power won't go on	A power supply that exceeds the rated range is used.	Use a power supply within the rated range.
	The power supply fuse is broken.	Request repair from NF Corporation or an NF Corporation sales representative.
	A malfunction occurred due to external noise.	Place this product in a location with favorable environmental conditions.
Panel operation is not possible.	The keys or MODIFY dial are defective.	Request repair from NF Corporation or an NF Corporation sales representative.
Nothing is displayed on the LCD.	The LCD contrast is too low.	Raise the contrast of the LCD. Even in an operating environment where the LCD display cannot be made out, the contrast can be adjusted by simultaneously pressing the ENTER key and CANCEL key. At this time, the digit cursor is on the decimal position.
The output value differs from the set value.	This product has not been sufficiently warmed up.	Warm up this product for 30 minutes or longer after power on.
	The ambient temperature and ambient humidity are not within the guaranteed operation range.	Use this product in an environment that matches the specification ranges.
	You want to output only AC, but the DC setting is not "0". Or, you want to output only AC, but the superimposed AC setting is not "0".	Make the settings of outputs that are not needed "0".
External control via USB is not possible.	A different interface setting from the program has been selected.	Perform the settings in accordance with the program.
	Restart has not been executed after switching USB interface.	When you switch USB interface, restart this product.
	The USB ID differs from the program when you are using USBTMC.	Set an USB ID in the program in accordance with this product.
	The USB ID differs from the program when you are using USB488.	Set an USB ID that matches the program.
	The USB ID is the same as that of another device when you are using USB488.	Set an USB ID that is unique.
I don't get the result as described in the user's manual.	Execute setting initialization.	The explanations in the user's manual assume the default settings. Initialize the settings. ( Refer to "4.9.8 Reset function".)

7.MAINTENANCE

7.1	Introduction	7-2
7.2	Daily Maintenance	7-2
7.3	Storage, Repacking, and Transportation	7-3
7.4	Version Number Verification Method	7-4
7.5	Cleaning the Air Filters	7-6
7.6	Backup Battery	7-7
7.7	Operation Inspection	7-8
7.8	Performance Test	7-10

7.1 Introduction

To ensure use of this product under the best possible conditions, it is important to perform maintenance as follows.

- Operation verification: Check performed to verify whether this product operates correctly.
- Performance test: Check performed to verify whether this product satisfies its ratings.
- Adjustment & calibration: If this product does not satisfy its ratings, its performance can be restored through adjustments and calibration by NF Corporation.
- Troubleshooting: If the above actions fail to yield improvements, NF Corporation will investigate the cause(s) of the fault and the fault location(s), and perform the necessary repairs.

This instruction manual explains operation inspections and performance tests that can be easily performed. For more detailed inspections, adjustments, calibration, and troubleshooting, contact NF Corporation or an NF Corporation sales representative.

Operation inspections and performance tests require the following measuring equipment.

- Oscilloscope Frequency band: 50 MHz or higher
- Frequency counter Standard oscillator stability: Within 10 ppm
- AC voltmeter TrueRMS type, accuracy: Within 0.2 %,
Frequency band: 300 kHz or higher
Recommended equipment: Agilent-made 3458A
- DC voltage meter Accuracy: Within 0.1 %
Recommended equipment: Agilent-made 34401A
- Distortion meter Full scale: 1 % or less, Frequency band: 100 kHz or higher
- Sine wave oscillator Amplitude: Within 3 V_{p-p}, Frequency: 10 Hz to 100 kHz,
Distortion: Within 0.2 %
- Resistance load 1.5 Ω/2400 W (BP4640)
1.2 Ω/3000 W (BP4650)
- Current measuring instrument 1 mΩ non-inductive current shunt or current sensor, 100 A or higher

7.2 Daily Maintenance

Use this product in a place that meets the installation conditions.

For the installation conditions,  refer to “2.2 Installation Environment”.

If the panel or case surface is soiled, wipe it with a soft cloth. In the case of resistant stains, wipe with a cloth that has been imbibed with a neutral detergent and then wrung well.

Wiping this product using an organic solvent such as thinner or benzene, or a pre-moistened wipe, may cause degradation in material quality, clouding, or flaking off of the paint, and must therefore be avoided.

7.3 Storage, Repacking, and Transportation

Store this product in a location that meets the installation conditions.

For the installation conditions,  refer to “2.2 Installation Environment”.

If repacking this product for transportation, etc., make sure that the box that is used is sufficiently strong and large to support the weight of this product and provide adequate protection.

During transportation, handle this product with care and protect it from strong shocks.



Be sure to include the instruction manual at transportation.

7.4 Version Number Verification Method

The firmware version of this product is for a few seconds at power-on.

At times other than power-on, the system information can be displayed and checked via the operation panel.

■ Operation procedure via operation panel

<1> Press the  and  keys to move the cursor to the  icon.

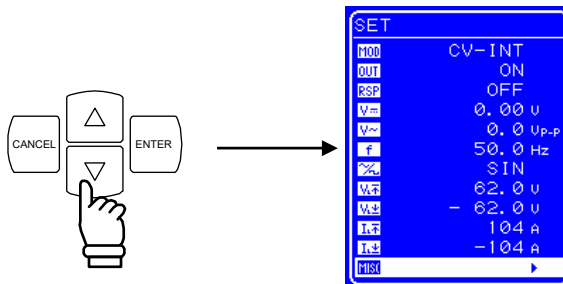

<2> Press the  key to display the MISC screen.

Press the  key to move the cursor to "SYSTEM".

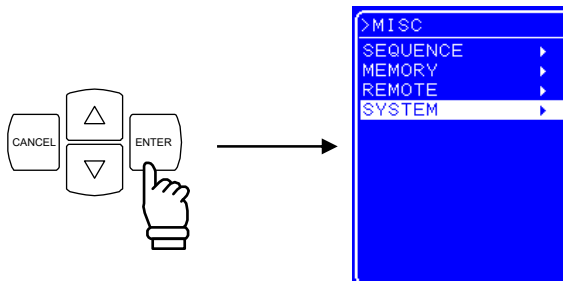

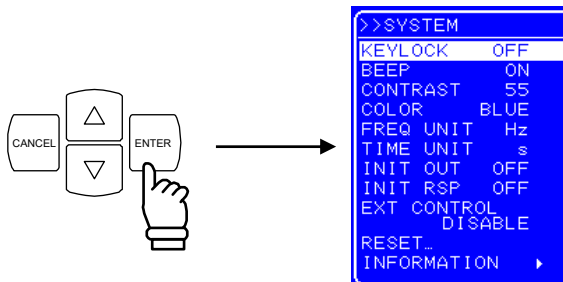

<3> Press the  key to display the SYSTEM screen.

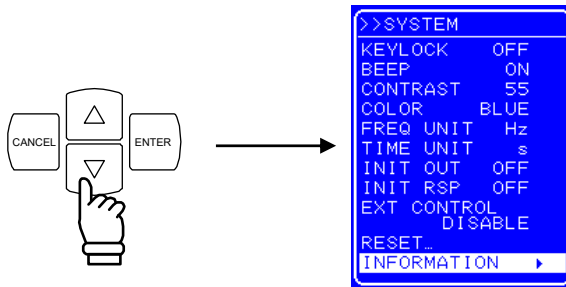

7.4 Version Number Verification Method

<4> Press the  key to move the cursor to “INFORMATION”.



<5> Press the  key to display the “SYSTEM INFORMATION” screen.

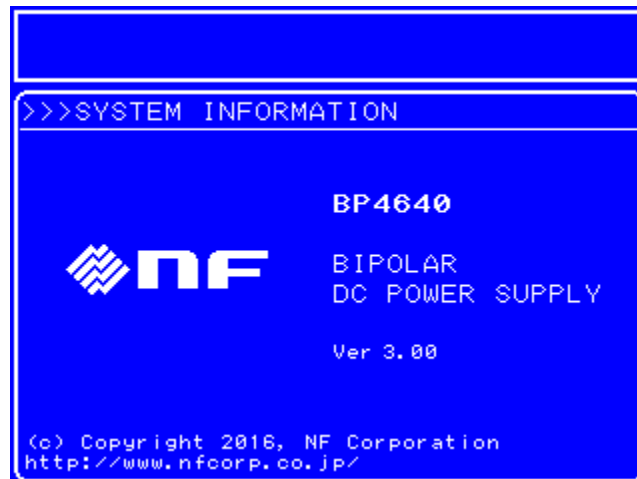
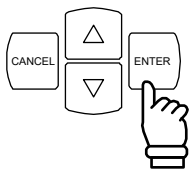

Figure 7-1. SYSTEM INFORMATION Screen

7.5 Cleaning the Air Filters

Dust and dirt that penetrates in this product and adheres inside may absorb the water content in the air and therefore cause rusting of metal parts, as well as cause a degradation in insulation performance leading to the failure of internal high-voltage parts.

Therefore, air filters (which number 5) are provided to eliminate dust and dirt contained in the inflowing air at the air intake vent on the front panel.

The dirt adhering to the filters, if not removed, will clog up the filters and reduce the air flow, causing the temperature inside this product to rise and lowering its reliability.

In such cases, remove the filter and clean out the dirt, as shown below. When rinsing with water, be sure to dry the filter thoroughly before reattaching it.

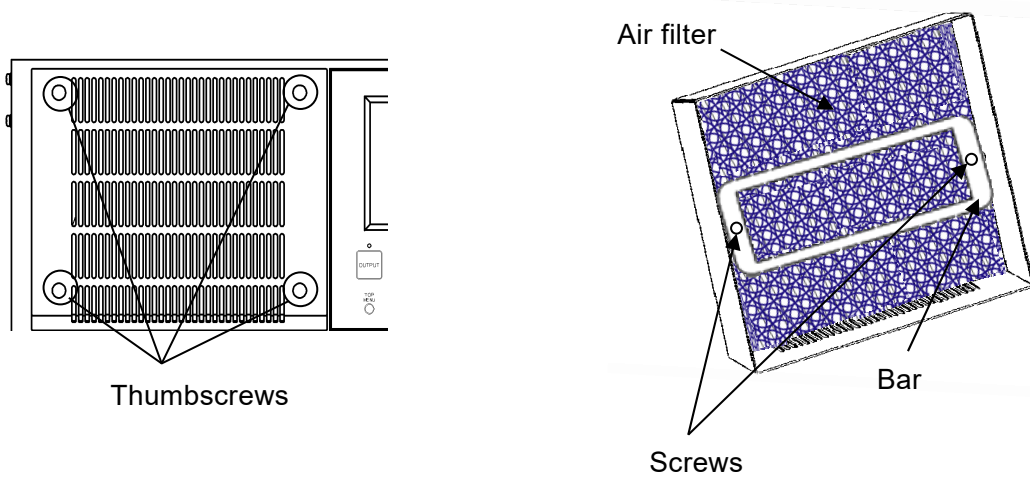

- (1) Remove the thumbscrews at the four corners of the air inlet piece on the front panel, and remove the air inlet.
- (2) Remove the screws on the back side of the air inlet piece and remove the bar
- (3) Remove the air filter from the inside of the air inlet piece, then clean air filter.
- (4) Follow the same procedure to remove and clean the other air filters.
- (5) After cleaning the air filters, make sure they are completely dry before performing steps (1) to (3) in reverse order to reattach them.



Figure 7-2. Air Filter Cleaning Procedure

Filter performance is not fail-proof as filter reliability can be degraded by extremely fine dirt (fine powder) and clogging. Therefore, installation of this product in a location filled with dust or dirt (including fine powder) or a location with high humidity where condensation can easily occur, should be avoided as much as possible.

7.6 Backup Battery

The contents of memory ( refer to “4.7 Memory Functions”) and other required parameters and data are backed up by the internal lithium battery of this product.

The backup period varies depending on the temperature and use conditions, but when left without power it is approximately five years.

The backed up contents are checked at power-on, and if the contents have become degraded, an error message is displayed ( refer to “6.1 Error Messages”) and the values of this product are reset to the initial values ( refer to “4.7 Memory Functions”).

If the backed up contents have been lost due to battery exhaustion, the  icon blinks.

In such cases, the battery must be replaced. Contact NF Corporation or our agents.

7.7 Operation Inspection

■ Verification before operation inspection

Before performing operation inspection, check the following items.

- Is the supply voltage within the rated range?
- Is the ambient temperature within the range of 5 to 35 °C?
- Is the ambient humidity within the range of 5 to 85 %RH? (with absolute humidity of 1 to 25 g/m³)
- Is there any condensation?

■ Check at power-on

Check that an error is displayed at power-on.

Check that the UNCAL icon and battery icon are not blinking.

(If an error is displayed,  refer to “6.1.1 Errors at power-on”.)

■ LCD screen check

Check that the characters, icons, and lines displayed on the LCD screen are not displaced, do not flicker, and free of bleeding.

■ Conditions during operation mode-specific function check

When performing the following operation-mode specific function checks, first initialize (execute RESET in the SYSTEM menu) the settings for each check to prevent incorrect settings.

Also,  connect the resistance load shown in “7.1 Introduction” to the output terminal of this product.

■ Check during CV mode internal signal source operation

Observe the voltage monitor output after connecting it to an oscilloscope. (The voltage of 1/100th the output voltage is monitored.)

In this state, try changing the settings listed below a number of times and check whether this product functions normally.

DC voltage, superimposed AC voltage, superimposed AC frequency, superimposed AC waveform, output on/off, voltage limiters (when the voltage limiters are set to a smaller value than the output voltage while this product is outputting superimposed AC voltage, clipping of the voltage frequency will occur and overload will be displayed on the LCD screen of this product).

■ Check during CC mode internal signal source operation

After performing setting initialization, set the operation mode to CC-INT.

Connect the current monitor output to an oscilloscope and observe it (About monitor output,  refer to “8.5 Monitor Output”).

In this state, try changing the settings listed below a number of times and check whether this product functions normally.

DC current, superimposed AC current, superimposed AC frequency, superimposed AC waveform, output on/off, current limiters (when the current limiters are set to a smaller value than the output current while this product is outputting superimposed AC current, clipping of the current waveform will occur and overload will be displayed on the LCD screen of this product).

■ Check during CV mode external signal input operation

After setting initialization has been performed, set the operation mode to CV-EXT.

Connect the output of the external oscillator to the external signal input of this product.

Connect the output of the external oscillator and the voltage monitor output to an oscilloscope and observe them.

In this state, try changing the output amplitude and frequency of the external oscillator and check whether this product functions normally. The amplitudes of the external oscillator output and voltage monitor output should be almost the same up to approximately 10 kHz.

■ Check during CC mode external signal input operation

After performing setting initialization, set the operation mode to CC-EXT.

Connect the output of the external oscillator to the external signal input of this product.

Connect the external oscillator output and the current monitor output to the oscilloscope and observe them.

In this state, try changing the external oscillator output amplitude and frequency and check whether this product functions normally. The amplitudes of the external oscillator output and the current monitor output should be almost the same up to approximately 2 kHz.

■ Check during CV mode adjusted characteristics operation

Turn all three response calibrator knobs counterclockwise all the way.

After performing setting initialization, switch on the response calibrator, the AC voltage to 100 Vp-p, the frequency to 10000 Hz, and the waveform to square wave.

Connect the voltage monitor output to the oscilloscope and observe it. (The voltage 1/100th the output voltage is monitored.)

In this state, turn all the knobs of the response calibrator and check whether the rise and fall characteristics of the square wave change. The degree of change varies according to the knobs.

Once the check has been completed, turn all three knobs of the response calibrator counterclockwise all the way, and switch off the response calibrator.

■ Check during CC mode adjusted characteristics operation

Turn the three response calibrator knobs counterclockwise all the way.

After performing setting initialization, switch on the response calibrator and set the AC current to 40 Ap-p (BP4640) or 50 Ap-p (BP4650), the frequency to 10000 Hz, and the waveform to square wave.

Connect the current monitor output to the oscilloscope and observe it. (About monitor output,  refer to "8.5 Monitor Output".)

In this state, try changing the three response calibrator knobs and check whether the rise and fall characteristics of the square wave change. The degree of change varies according to the knobs.

Once the check has been completed, turn all three knobs of the response calibrator counterclockwise all the way, and switch off the response calibrator.

■ USB Check

Change some of the settings that were used for checking the main functions of this product and check whether the same output changes are obtained.

At that time, check whether "RMT" is displayed on the screen.

Also, check that when the [LOCAL] key is pressed, the "RMT" display disappears and the local status is returned to (when the status is other than local lockout).

7.8 Performance Test

■ Performance test

Performance testing is performed as part of preventive maintenance in order to prevent performance degradation of this product. To facilitate execution, this test is performed under conditions that partially differ from the specifications, as the test items, used measuring equipment, and load condition are limited for the sake of convenience. If more extensive testing is required, contact NF Corporation or an NF Corporation sales representative.

Performance testing should be performed as part of acceptance inspection, periodic inspection, performance verification following repair of this product, etc.

If, as the result of performance testing, this product is found not to meet its specifications, repair is necessary. In this case, contact NF Corporation or an NF Corporation sales representative.

■ Verification prior to performance testing

Prior to performance testing, check the following items.

- Is the power supply voltage within the rated range?
- Is the ambient temperature within 23 ± 5 °C?
- Is the ambient relative humidity within the range of 20 to 70 %RH?
- Is there any condensation?
- Has this product been warmed up for 30 minutes or longer?

■ Preparations prior to performance testing

Use a cable with a cross section of 8 mm² or more and a length of 2 m or less for connecting the load.

The setting contents of each test item include items that can be changed after performing setting initialization (by executing RESET in SYSTEM menu). After checking the setting contents, switch on the output.

■ Maximum output voltage test using CV mode external signal input

Load: Resistance load (About Resistance load,  refer to “7.1 Introduction”.)

Measurement connection: Connect the output of the external oscillator to the external signal input of this product. Then connect an AC voltmeter and distortion meter to the output terminal of this product and measure the voltage and distortion.

Settings: After performing setting initialization, set the operation mode and external oscillator frequency according to the following table.

Judgment: Gradually increase the output voltage of the external oscillator from 1 Vp-p (the output voltage of this product is 100 Vp-p, 35.4 Vrms), and if the output voltage of this product immediately before the distortion exceeds 1 % or overload occurs falls within the rated range indicated in the following table, the operation is judged to be normal.

Operation Mode Setting	External Oscillator Frequency	Rated Range
CV-EXT	50 Hz	42.43 Vrms or higher
	500 Hz	42.43 Vrms or higher

■ Maximum output current test using CC mode external signal input

Load: Shorted via current measuring instrument.

Measurement connection: Connect the output of the external oscillator to the external signal input of this product. Then connect the detection voltage of the current measuring instrument to an AC voltmeter and distortion meter, and measure the current and distortion.

Settings: After performing setting initialization, set the operation mode and external oscillator frequency according to the following table.

Judgment: Gradually increase the output voltage of the external oscillator from 1.6 Vp-p, and if the output voltage of this product immediately before the distortion exceeds 1 % or overload occurs falls within the rated range indicated in the following table, the operation is judged to be normal.

Operation Mode Setting	Model	External Oscillator Frequency	Rated Range
CC-EXT	BP4640	50 Hz	28.28 Arms or higher
		500 Hz	28.28 Arms or higher
CC-EXT	BP4650	50 Hz	35.36 Arms or higher
		500 Hz	35.36 Arms or higher

■ Harmonic distortion test using CV mode external signal input

Load: Resistance load (About Resistance load,  refer to “7.1 Introduction”).

Measurement connection: Connect the output of the external oscillator to the external signal input of this product. Then connect an AC voltmeter and distortion meter to the output terminal of this product, and measure the voltage and harmonic distortion.

Settings: After performing setting initialization, set the operation mode and external oscillator frequency according to the following table. Set the output voltage of the external oscillator to 1.2 Vp-p. Check that the output voltage of this product is 120 Vp-p.

Judgment: If the harmonic distortion of the output voltage of this product falls within the rated ranges indicated in the following table, the operation is judged to be normal.

Operation Mode Setting	External Oscillator Frequency	Rated Range
CV-EXT	10 Hz	1 % or less
	10 kHz	1 % or less

■ Harmonic distortion test using CC mode external signal input

Load: Resistance load (About Resistance load,  refer to “7.1 Introduction”).

Measurement connection: Connect the output of the external oscillator to the external signal input of this product. Then connect an AC voltmeter and a distortion meter to the output terminal of this product, and measure the voltage and frequency distortion.

Settings: After performing setting initialization, set the operation mode and external oscillator frequency according to the following table. Set the output voltage of the external oscillator to 2 Vp-p. Check whether the output voltage of this product is 120 Vp-p. If overload seems likely to occur, slightly lower the output voltage of the external oscillator.

Judgment: If the harmonic distortion of the output voltage of this product falls within the rated ranges in the following table, the operation is judged to be normal.

Operation Mode Setting	External Oscillator Frequency	Rated Range
CC-EXT	10 Hz	1 % or less
	10 kHz	1 % or less

■ **Output DC offset test during external input short**

Load: Resistance load (About Resistance load,  refer to “7.1 Introduction”.)

Measurement connection: Short the external input terminal (installation of a 50 Ω or 75 Ω termination resistor is also possible). Measure the voltage of the output terminal of this product with a DC voltmeter. In the case of the CC mode, convert the measured voltage value into a current value by dividing it by the load resistance.

Settings: After performing setting initialization, set the operation mode according to the following table.

Judgment: If the output voltage or output current of this product falls within the rated ranges in the following table, the operation is judged to be normal.

Operation Mode Setting	Model	Rated Range
CV-EXT	All models	-0.1 to +0.1 V
CC-EXT	BP4640	-0.2 to +0.2 A (load voltage: -0.3 to +0.3 V)
	BP4650	-0.25 to +0.25 A (load voltage: -0.3 to +0.3 V)

■ **Residual noise test during external input short**

Load: Resistance load (About Resistance load,  refer to “7.1 Introduction”.)

Measurement connection: Short the external input terminal (installation of a 50 Ω or 75 Ω termination resistor is also possible). Measure the voltage of the output terminal of this product with a DC voltmeter. In the case of the CC mode, convert the measured voltage value into a current value by dividing it by the load resistance.

Settings: After performing setting initialization, set the operation mode according to the following table.

Judgment: If the output voltage or output current of this product falls within the rated ranges in the following table, the operation is judged to be normal.

Operation Mode Setting	Model	Rated Range
CV-EXT	All models	50 mVrms or lower
CC-EXT	BP4640	32 mArms or lower (load voltage: 48 mVrms or lower)
	BP4650	40 mArms or lower (load voltage: 48 mVrms or lower)

■ **Output voltage limiter accuracy test**

Load: No load

Measurement connection: Measure the voltage of the output terminal of this product with a DC voltmeter.

Settings: After performing setting initialization, set the output voltage limiters and DC output voltage according to the following table.

Judgment: If the output voltage of this product falls within the rated ranges in the following table, the operation is judged to be normal. This is the output voltage when overload has occurred. The output is switched off after approximately 10 seconds.

+ Voltage Limiter Setting	- Voltage Limiter Setting	DC Output Voltage Setting	Rated Range
+112 V	-12 V	+115 V	+111 to +113 V
+12 V	-112 V	-115 V	-113 to -111 V

■ **Output current limiter accuracy test**

Load: Short via a current measuring instrument

Measurement connection: Measure the detection voltage of the current measuring instrument with a DC voltmeter and convert the measured value to a DC value.

Settings: After setting initialization has been performed, set the + current limiter, – current limiter, output voltage limiter and DC output voltage according to the following table.

Judgment: If the output current of this product falls within the rated ranges in the following table, the operation is judged to be normal. This is the output current when overload has occurred. The output is switched off after approximately 10 seconds.

Model	+ Current Limiter Setting	– Current Limiter Setting	+ Voltage Limiter Setting	– Voltage Limiter Setting	DC Output Voltage Setting	Rated Range
BP4640	+40 A	–40 A	+52 V	–72 V	+10 V	+36 to +44 A
			+72 V	–52 V	–10 V	–44 to –36 A
BP4650	+50 A	–50 A	+52 V	–72 V	+10 V	+45 to +55 A
			+72 V	–52 V	–10 V	–55 to –45 A

■ **Amplitude accuracy test of CV mode internal DC signal source**

Load: No load

Measurement connection: Measure the voltage of the output terminal of this product with a DC voltmeter.

Settings: After setting initialization has been performed, set the output voltage limiters and DC output voltage according to the following table.

Judgment: If the output voltage of this product falls within the rated ranges in the following table, the operation is judged to be normal.

+ Voltage Limiter Setting	– Voltage Limiter Setting	DC Output Voltage Setting	Rated Range
+117 V	–7 V	+115 V	+114.23 to +115.77 V
+7 V	–117 V	–115 V	–115.77 to –114.23 V

■ **Amplitude accuracy test of CC mode internal DC signal source**

Load: Short via a current measuring instrument

Measurement connection: Measure the detection voltage of the current measuring instrument with a DC voltmeter and convert the measured value to a DC value.

Settings: After setting initialization has been performed, set the operation mode and DC output current according to the following table.

Judgment: If the output current of this product falls within the rated ranges in the following table, the operation is judged to be normal.

Operation Mode Setting	Model	DC Output Current Setting	Rated Range
CC-INT	BP4640	+40A	+39.68 to +40.32 A
		–40 A	–40.32 to –39.68 A
	BP4650	+50A	+49.60 to +50.40 A
		–50 A	–50.40 to –49.60 A

■ **Frequency accuracy test of internal AC signal source**

Load: Resistance load (About Resistance load, refer to “7.1 Introduction”.)

Measurement connection: Measure the signal (1 V_{p-p}) of the voltage monitor output terminal of this product with a frequency counter.

Settings: After setting initialization has been performed, set the frequency and AC output voltage according to the following table.

Judgment: If the output frequency of the voltage monitor of this product falls within the rated range in the following table, the operation is judged to be normal.

Frequency Setting	AC Output Voltage Setting	Rated Range
10000 Hz	100 V _{p-p}	9999 to 10001 Hz

7.8 Performance Test

■ Amplitude accuracy test of CV mode internal AC signal source

Load: Resistance load (About Resistance load, refer to “7.1 Introduction”.)

Measurement connection: Measure the voltage of the output terminal of this product with an AC voltmeter.

Settings: After setting initialization has been performed, set the frequency and AC output voltage according to the following table.

Judgment: If the output voltage of this product falls within the rated ranges in the following table, the operation is judged to be normal.

Frequency Setting	AC Output Voltage Setting	Rated Range
500 Hz	120 Vp-p	119.2 to 120.8 Vp-p (42.15 to 42.70 Vrms)
	10 Vp-p	9.75 to 10.25 Vp-p (3.446 to 3.623 Vrms)

■ Amplitude accuracy test of CC mode internal AC signal source

Load: Short via a current measuring instrument

Measurement connection: Measure the detection voltage of the current measuring instrument with an AC voltmeter, and convert the measured value to a current value.

Settings: After setting initialization has been performed, set the operation mode, frequency, and AC output current according to the following table.

Judgment: If the output current of this product falls within the rated ranges in the following table, the operation is judged to be normal.

Operation Mode Setting	Frequency Setting	Model	AC Output Current Setting	Rated Range
CC-INT	500 Hz	BP4640	120 Ap-p	119.28 to 120.72 Ap-p (42.17 to 42.68 Arms)
			12 Ap-p	11.82 to 12.18 Ap-p (4.18 to 4.31 Arms)
CC-INT	500 Hz	BP4650	150 Ap-p	149.10 to 150.90 Ap-p (52.71 to 53.35 Arms)
			15 Ap-p	14.78 to 15.23 Ap-p (5.22 to 5.38 Arms)

■ DC output voltage measurement accuracy test

Load: No load

Measurement connection: Measure the voltage of the output terminal of this product with a DC voltmeter.

Settings: After setting initialization has been performed, set the output voltage limiters and current output voltage according to the following table.

Judgment: If the difference between the DC voltage measurement display value of this product and the value measured with the DC voltmeter falls within the rated ranges in the following table, the operation is judged to be normal.

+ Voltage Limiter Setting	- Voltage Limiter Setting	DC Output Voltage Setting	Rated Range
+117 V	-7 V	+115 V	-0.5 to +0.5 V
+7 V	-117 V	-115 V	-0.5 to +0.5 V

■ DC output current measurement accuracy test

Load: Short via a current measuring instrument

Measurement connection: Measure the detection voltage of the current measuring instrument with a DC voltmeter and convert the measured value to a DC value.

Settings: After setting initialization has been performed, set the operation mode and the DC output current according to the following table.

Judgment: If the difference between the DC current measurement display value of this product and the current value measured with the DC voltmeter falls within the rated ranges in the following table, the operation is judged to be normal.

Operation Mode Setting	Model	DC Output Current Setting	Rated Range
CC-INT	BP4640	+40 A	-0.4 to +0.4 A
		-40 A	-0.4 to +0.4 A
CC-INT	BP4650	+50 A	-0.5 to +0.5 A
		-50 A	-0.5 to +0.5 A

8. SPECIFICATIONS

8.1	Specification Conditions	8-2
8.2	Output	8-3
8.3	Output Limiters	8-5
8.4	Signal Sources	8-6
8.4.1	Internal signal source	8-6
8.4.2	External signal input	8-7
8.5	Monitor Output	8-8
8.6	Measurement Functions	8-9
8.7	Sequence Function	8-10
8.8	Arbitrary Waveform Memory	8-10
8.9	Setting Memory	8-11
8.10	Protective Functions	8-11
8.11	General	8-11
8.12	External Control I/O	8-12
8.13	USB Interface	8-12
8.14	Power Input	8-13
8.15	Withstand Voltage, Insulation Resistance	8-13
8.16	Ambient Temperature Range and Ambient Humidity Range	8-13
8.17	External Dimensions and Weight	8-14
8.18	EMC	8-14
8.19	Option	8-15
8.20	Output Voltage and Output Current Supply Ranges	8-15
8.21	Drawing of External Dimensions	8-20

A value with the accuracy is the guaranteed value, but a value without the accuracy is the reference value or representative value (shown as typ.).

All of the adjusted characteristics values are also for reference value only.

The reference value shows the supplemental data for reference when the product is used, and is not under the guarantee.

8.1 Specification Conditions

The power input voltage is noted as line voltage in three-phase four-wire input, unless otherwise noted.

Specifications are valid under the following settings and conditions and after a warm-up period of 30 minutes at least, unless otherwise noted.

Item	BP4640	BP4650
Output frequency	1 kHz	
Signal	External input signal	
Output waveform	Sine wave (DC = 0 V)	
Output voltage	±60 V	
Output current	±40 A	±50 A
Load	1.5 Ω	1.2 Ω
Response characteristics	Fixed characteristics	
Output voltage limiter setting	±62 V	
Output current limiter setting	±104 A	±130 A

In this chapter, the terms “fixed characteristics” and “adjusted characteristics” have the following meanings.

■ Fixed characteristics

These characteristics are fixed when this product is shipped and cannot be changed by the user. They are set with the aim to achieve both wide frequency band characteristics and load stability.

■ Adjusted characteristics

These characteristics are adjusted by the user for the CV or CC mode using the response calibration function, so as to achieve the fastest possible step response waveform rise time and fall time, as well as overshoot, undershoot, and sag that fall within ±12 % of the P-P amplitude in the CV mode or within ±5 % of the P-P amplitude in the CC mode.

8.2 Output

■ Output in the constant voltage (CV) mode

Item		BP4640	BP4650	
Maximum output voltage	DC *1	+115 V	(+Vo limit +117 V, -Vo limit -7 V setting)	
		-115 V	(+Vo limit +7 V, -Vo limit -117 V setting)	
	Adjusted characteristics	DC to 0.5 kHz	±60 V	
		0.5 kHz to 40 kHz	±60 V *2	
		40 kHz to 150 kHz	±50 V	
	Fixed characteristics	DC to 0.5 kHz	±60 V	
0.5 kHz to 40 kHz		±60 V *2		
Small amplitude frequency characteristics *3	Adjusted characteristics	DC to 20 kHz	±0.5 dB	
		20 kHz to 200 kHz	+1, -3 dB	
	Fixed characteristic	DC to 10 kHz	±0.5 dB	
		10 kHz to 35 kHz	+1, -3 dB	
Harmonic distortion		1 % or less (10 Hz to 10 kHz)		
Rise/fall time		2.5 μs (adjusted characteristics, square wave ±60 V)		
Output impedance *4		1.8 mΩ + 0.33 μH	1.4 mΩ + 0.31 μH	
Line regulation (typ.) *5		±0.1 % or less		
Output DC offset *6		±0.1 V or less		
Residual noise (rms, typ.) *7		50 mV or less		

*1: For the following load.

Item	BP4640	BP4650
Resistance load	5.8 Ω	4.6 Ω

*2: For the following load.

Item	BP4640	BP4650
Resistance load	1.0 Ω	0.80 Ω

*3: Output amplitude 12 V_{p-p}, 500 Hz reference.

*4: Adjusted characteristics.

*5: Power supply voltage of 180 V to 250 V (3P3W) or 323 V to 433 V (3P4W)

*6: Input terminal short.

*7: Input terminal short, measurement band 10 Hz to 300 kHz

8.2 Output

■ Output in the constant voltage (CC) mode

Item			BP4640	BP4650
Maximum output voltage	Adjusted characteristics	DC to 0.5 kHz	±40 A	±50 A
		0.5 kHz to 30 kHz	±60 A *1	±75 A *1
		30 kHz to 70 kHz	±33.2 A	±41.5 A
	Fixed characteristics	DC to 0.5 kHz	±40 A	±50 A
		0.5 kHz to 3 kHz	±60 A *1	±75 A *1
		3 kHz to 10 kHz	±52 A *1	±65 A *1
Small amplitude frequency characteristics *3	Adjusted characteristics	DC to 20 kHz	±0.5 dB	
		20 kHz to 70 kHz	+1, -3 dB	
	Fixed characteristic	DC to 2 kHz	±0.5 dB	
		2 kHz to 8 kHz	+1, -3 dB	
Harmonic distortion			1 % or less (10 Hz to 10 kHz)	
Rise/fall time *3			4 μs	
Output impedance *4			2.5 kΩ//1.8 μF	2 kΩ//2.25 μF
Line regulation (typ.) *5			±0.1 % or less	
Output DC offset *6			±0.2 A or less	±0.25 A or less
Residual noise (rms, typ.) *7			32 mA or less	40 mA or less

*1: For the following load.

Item	BP4640	BP4650
Resistance load	1.0 Ω	0.80 Ω

*2: Output amplitude 12 Vp-p, 500 Hz reference.

*3: Adjusted characteristics, square wave, for the following current.

Item	BP4640	BP4650
Current	±40 A	±50 A

*4: Adjusted characteristics.

*5: Power supply voltage of 180 V to 250 V (3P3W) or 323 V to 433 V (3P4W)

*6: Input terminal short.

*7: Input terminal short, measurement band 10 Hz to 300 kHz

■ Output terminal

Item	BP4640	BP4650
Output terminal *1	M8 screw	

*1: Output terminal block is on the rear panel, common in the CV and CC mode. The Lo side is connected to the chassis.

■ Output voltage, current supply range

 Refer to “8.19 Output Voltage and Output Current Supply Ranges”.

■ Response characteristics switching

Fixed characteristics or adjusted characteristics

■ Response calibration function

If adjusted characteristics are selected as the response characteristics, the response characteristics adjusted by the user can be used. The distortion of the output waveform associated with the load conditions can be improved through adjustments. Higher or lower speed than the fixed characteristics can be achieved through adjustments.

Adjustments are performed by operating the three adjustment knobs (located beneath the operation panel) for the time constant, voltage feedback amount, and current feedback amount, while watching the output voltage and current waveform on an external oscilloscope.

8.3 Output Limiters

■ Output voltage limiters

Item	Description
+ voltage setting range (+Vo limit)	+7 V to +117 V (initial value: +62 V)
– voltage setting range (–Vo limit)	–117 V to –7 V (initial value: –62 V)
Setting resolution	0.1 V
Setting accuracy	±1 V (DC)

Remark: The difference between the + voltage setting and the – voltage setting is restricted to 24 V or higher and 124 V or lower.

The output voltage and output current supply ranges are determined by the output voltage limiter settings.

Depending on the operation conditions, the output voltage may be limited to a narrower range than the voltage limiter settings.

 Refer to “8.19 Output Voltage and Output Current Supply Ranges”.)

■ Output current limiters

Item	BP4640	BP4650
+ current setting range (+I _o limit)	+4 A to +104 A (initial value: +104 A)	+5 A to +130 A (initial value: +130 A)
- current setting range (-I _o limit)	-104 A to -4 A (initial value: -104 A)	-130 A to -5 A (initial value: -130 A)
Setting resolution	1 A	
Setting accuracy (DC) *1	±4 A	±5 A

Remark: The source current is considered to be positive.

Depending on the operation conditions, the output current may be limited to a narrower range than the current limiter settings.

(Refer to “8.19 Output Voltage and Output Current Supply Ranges”.)

*1: For DC current within the following current value.

Item	BP4640	BP4650
Current	±40 A	±50 A

8.4 Signal Sources

The signal source can be selected from among internal signal source, external signal source, and internal signal source + external signal source.

8.4.1 Internal signal source

■ CV mode

Item		Description
DC voltage	Setting range	-115 V to +115 V
	Setting resolution	0.01 V
	Setting accuracy *1	±(0.5 % of setting value + 0.2 V)
AC voltage	Amplitude setting range	0 V _{p-p} to 120 V _{p-p}
	Amplitude setting resolution	0.1 V _{p-p}
	Amplitude setting accuracy *2	±(0.5 % of setting value + 0.2 V _{p-p})
	Waveform	Sine, square, arbitrary (16 types)
	Frequency setting range	1 Hz to 100 kHz
	Frequency setting resolution	0.1 Hz
	Frequency setting accuracy	±100 ppm

*1: AC 0 V, DC only, 23 ±5 °C, and for the following load.

Item	BP4640	BP4650
Resistance load	5.8 Ω	4.6 Ω

*2: DC 0 V, AC only, 500 Hz sine wave, 23 ±5 °C.

8.4 Signal Sources

■ CC mode

Item		BP4640	BP4650
DC current	Setting range	-40 A to +40 A	-50 A to +50 A
	Setting resolution	0.01 A	
	Setting accuracy *1	$\pm(0.5\% \text{ of setting value} + 0.12 \text{ A})$	$\pm(0.5\% \text{ of setting value} + 0.15 \text{ A})$
AC current	Amplitude setting range	0 Ap-p to 120 Ap-p	0 Ap-p to 150 Ap-p
	Amplitude setting resolution	0.1 Ap-p	
	Amplitude setting accuracy *2	$\pm(0.5\% \text{ of setting value} + 0.12 \text{ Ap-p})$	$\pm(0.5\% \text{ of setting value} + 0.15 \text{ Ap-p})$
	Waveform	Sine, square, arbitrary (16 types)	
	Frequency setting range	1 Hz to 100 kHz	
	Frequency setting resolution	0.1 Hz	
	Frequency setting accuracy	$\pm 100 \text{ ppm}$	

*1: AC 0 A, DC only, $23 \pm 5^\circ\text{C}$.

*2: DC 0 A, AC only, 500 Hz sine wave, $23 \pm 5^\circ\text{C}$, and for the following load.

Item	BP4640	BP4650
Resistance load	1.0 Ω	0.80 Ω

8.4.2 External signal input

■ Common to CV and CC mode

Item	Description
Phase	In phase
Gain accuracy	$\pm 5\%$ (1 kHz)
Input impedance	10 k Ω
Non-destructive max. input voltage	$\pm 5 \text{ V}$
Input terminal	BNC connector (front panel)
Frequency range	DC to 200 kHz

■ CV mode

Item	Description
Gain	100
Input voltage range	$\pm 1.15 \text{ V}$

8.5 Monitor Output

■ CC mode

Item	BP4640	BP4650
Gain	40 A/V	50 A/V
Input voltage range	±1.5 V	

8.5 Monitor Output

■ Output voltage monitor output

Item	Description	
Monitor ratio	1/100	
Phase	In phase	
Monitor accuracy *1	±1.2 V	
Frequency characteristics *2	DC to 40 kHz	±0.5 dB
	40 kHz to 400 kHz	+1 dB, -3 dB
Output impedance	50 Ω	
Output terminal	BNC connector (front panel)	

*1: Difference between DC output voltage and conversion voltage obtained from monitor voltage, 1 MΩ monitor output load impedance.

*2: 1 kHz reference, 1 MΩ monitor output load impedance

■ Output current monitor output

Item	BP4640	BP4650
Monitor ratio *1	1/40	1/50
Phase	In phase	
Monitor accuracy *2	±0.8 A	±1 A
Frequency characteristics *3	DC to 20 kHz	±0.5 dB
	20 kHz to 200 kHz	+1 dB, -3 dB
Output impedance	50 Ω	
Output terminal	BNC connector (front panel)	

*1: Output voltage multiplied by monitor ratio against output current. (V/A)

*2: Difference between DC output current and conversion current obtained from monitor voltage, 1 MΩ monitor output load impedance.

*3: 1 kHz reference, 1 MΩ monitor output load impedance

8.6 Measurement Functions

■ DC output voltage measurement

Item	Description
Full scale	± 200 V
Resolution	0.1 V
Measurement accuracy	± 0.5 V (within DC ± 115 V, AC 0 V)

Remark: Measures AC + DC average. However, AC + DC must be within full scale.

■ DC output current measurement

Item	BP4640	BP4650
Full scale	± 80 A	± 100 A
Resolution	0.1 A	
Measurement accuracy *1	± 0.4 A	± 0.5 A

Remark: Measures AC + DC average. However, AC + DC must be within full scale.

*1: Within max. DC output current, AC 0 A.

■ AC output voltage measurement

Item	Description
Full scale	± 400 Vp-p
Resolution	1 Vp-p
Measurement accuracy	± 2 Vp-p (DC 0 V, 120 Vp-p, 500 Hz)
Measurement frequency band	10 kHz/-3 dB

Remark: Measures max. value of AC+DC – min. value of AC + DC. However, AC + DC must be within full scale of DC output voltage measurement.

■ AC output current measurement

Item	BP4640	BP4650
Full scale	160 Ap-p	200 Ap-p
Resolution	1 Ap-p	
Measurement accuracy *1	± 4 Ap-p	± 5 Ap-p
Measurement frequency band	10 kHz/-3 dB	

Remark: Measures max. value of AC + DC – min. value of AC + DC. However, AC + DC must be within full scale of DC output current measurement.

*1: Within max. output current, DC 0 A, 500Hz.

8.7 Sequence Function

The output parameters can be rapidly changed sequentially or swept.

The signal source is limited to internal signal or internal signal + external signal input.

The sequence function settings are saved to battery backed up memory.

Item		Description
Number of sequences		1 sequence for each of the CV mode and CC mode
Number of steps		1 to 255 (within 1 sequence)
Step time	Setting range	0.1 ms to 999.9999 s
	Setting resolution	0.1 ms
Operation within step		Constant or linear sweep
Parameters *1	CV mode	DC voltage, superimposed AC voltage, frequency, waveform Step sync output, 2 bits
	CC mode	DC current, superimposed AC current, frequency, waveform Step sync output, 2 bits
Jump count		1 to 999, or continuous
Sequence control	Start	Starts sequence.
	Stop	Stops sequence.
	Hold	Maintains settings at that point in time. The operation resumes at sequence start.
	Branch	Branches to the specified step.

*1: If a sine wave or square wave is selected as the waveform, the waveform cannot be changed during the sequence. If arbitrary waveform is selected, an arbitrary wave can be specified for each step.

8.8 Arbitrary Waveform Memory

The arbitrary waveform memory is memory for the superimposed AC of the internal signal source. It is battery backed up.

Write to arbitrary waveform memory from the operation panel is not possible. Write is performed via the USB interface.

Item	Description
Number of waveform memories	16
Waveform length	1024 words
Waveform data	16 bit

8.9 Setting Memory

Settings are backed up and the settings that were applied the previous time this product was powered off can be restored the next time is powered on. However, the selected response characteristics are not saved. Moreover, among the various settings, the basic settings (operation mode, DC, superimposed AC, output limiters) can be saved to store/recall memories No. 1 to No. 30, and the saved settings can be called and used.

The store/recall memory call operation is possible only when the output is off.

8.10 Protective Functions

Item	Description
Output overload	If output voltage over, output current over, or internal output loss over is detected, overload is displayed on the panel screen, and the output voltage or current is reduced. If the overload status continues 10 or more seconds, the output is switched off.
Power supply anomaly	Upon anomaly detection, the output and power are both switched off.
Internal overheating	Upon anomaly detection, the output and power are both switched off.
Operation panel anomaly	Upon detection of an operation panel anomaly such as the operation panel being disconnected from the main unit, the output and power are both switched off.

8.11 General

Item	Description	
LCD display settings	Contrast	Adjustable
	Display color	Blue or white
Beep	On or off If on, a beep is emitted during key operation and malfunction. A warning sound is emitted upon overload detection, regardless of this setting.	
Keylock	On or off In the on status, only keylock off operation and output off operation are possible.	
Output setting at power-on	On or off When on, the output is automatically switched on at power-on.	
Response characteristics setting at power-on	On or off When on, the response characteristics are automatically set to adjusted characteristics at power-on.	
Reset function	Returns the basic settings to the factory default settings.	
Self-diagnosis function	Performs check of each memory at power-on.	

8.12 External Control I/O

Item		Description	
External control operation mode		Enabled or disabled (Status output is always on.)	
Control input	Input level	High level:+4.0 V or higher, Low level: +1.0 V or lower	
	Non-destructive max. input	+10 V/-5 V	
	Input impedance	Pulled up to +5 V with 47 k Ω	
	Detection cycle	2 ms	
	Control items	Output OFF	Output off at fall
		Output ON	Output on at fall
		Sequence start	Sequence start at fall
		Sequence stop	Sequence stop at fall
Hold input		Hold at fall	
Branch input 0, 1	Branch start at fall		
Status output	Output level	0/+5 V (open)	
	Output impedance	100 Ω	
	Switching cycle	0.1 ms	
	Status items	Power on/off status	0-OFF, 1-ON
		Output on/off status	0-OFF, 1-ON
		Overload	0-Normal, 1-Overload
Software busy		0-Normal, 1-Busy	
Sequence operation step sync output	0, 1 (selectable)		
Terminal		D-sub 25-pin multi connector (rear panel, female, M2.6 screw)	

8.13 USB Interface

A USB interface is provided for performing control from an external computer.

Item		Description
Interface standard		USB 1.1, USBTMC / USB488
USB ID	USBTMC	USB ID has been assigned to each instrument
	USB488	1 to 65534

8.14 Power Input

Either three-phase three-wire input (3P3W) or three-phase four-wire input (3P4W) can be chosen when ordering.

Item	BP4640	BP4650
Power input voltage range	Three-phase three-wire input (3P3W) 200 V to 230 V $\pm 10\%$, with limited to 250 V or lower Three-phase four-wire input (3P4W) 380 V (phase voltage 220 V) $\pm 15\%$, with limited to 433 V (phase voltage: 250 V) or lower	
Power supply frequency range	50/60 Hz ± 2 Hz	
Power supply input terminal (rear)	M8 screw	
Power factor *1	Approximately 0.93	
Power consumption *1	4.8 kVA	6 kVA
Overvoltage category	II	

*1: Power input voltage 200 V (3P3W) or 380 V (3P4W), CV mode, only DC ± 60 V output

8.15 Withstand Voltage, Insulation Resistance

Item	Description
Withstand voltage	AC 1500 V
Insulation resistance	10 M Ω or higher (DC 500 V)

Power supply input terminals in batch vs. Other terminals and chassis in batch

8.16 Ambient Temperature Range and Ambient Humidity Range

Item	Description
Operating environment	Indoor use
Altitude	Up to 2,000 m
Performance guarantee *1	+5 to +35 °C/5 to 85 %RH
Storage conditions *2	-10 to +50 °C/5 to 95 %RH
Pollution degree	2

*1: However, the absolute humidity must be 1 to 25 g/m³, with no condensation

*2: However, the absolute humidity must be 1 to 29 g/m³, with no condensation

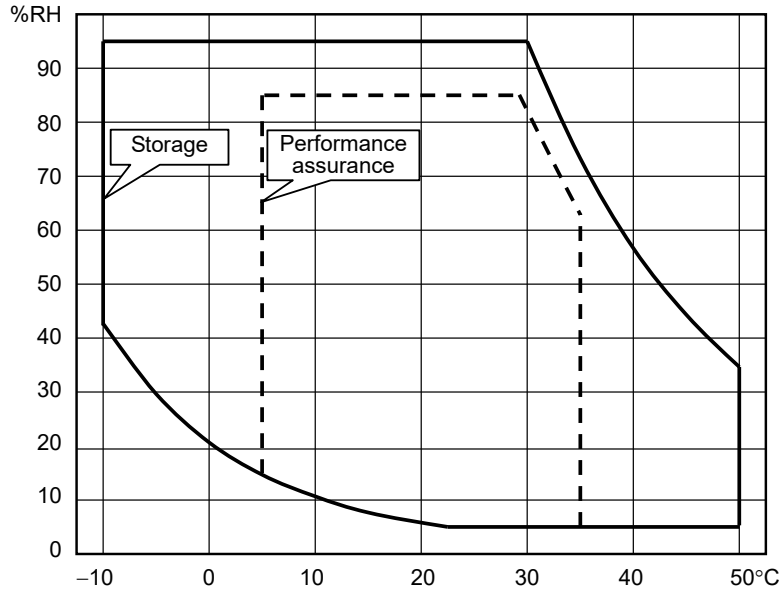

Figure 8-1. Ambient Temperature and Humidity Ranges

8.17 External Dimensions and Weight

Item	BP4640	BP4650
External dimensions (Width × Height × Depth, not including projections)	505×1150×700 mm	
Weight	Approximately 165 kg	Approximately 180 kg

8.18 EMC

Compliant with the following standard requirement (only if the power input is three-phase four-wire input)

KN 11 (Group 1, Class A)

KN 61000-6-2

The following phenomena may occur if this product is exposed to a strong radiated radio frequency electromagnetic field or a strong radio frequency conducted disturbance.

- Indication malfunction of measured values or LED
- The monitor output fluctuation
- The current limiter operation

Electromagnetic emissions from this product may interfere with reception of radio and television broadcasts. Unless the user takes special measures to reduce electromagnetic emissions, using this product in a residential area must be avoided.

For compliant manufacturing lot, please contact us or our agent.

8.19 Option

Option name	Description	Remarks
Replacement Air Filter PA-001-3023 (1S) PA-001-3024 (2S)	A replacement air filter. The quantity required per product is 1 and 4 in order from top to bottom.	On order and after purchase
Fixing Bracket (BP4640/4650) PA-001-3027	The fixing bracket is a set of brackets used to fix the product on floors.	On order and after purchase

(Reference) The type and use of air filters are following.

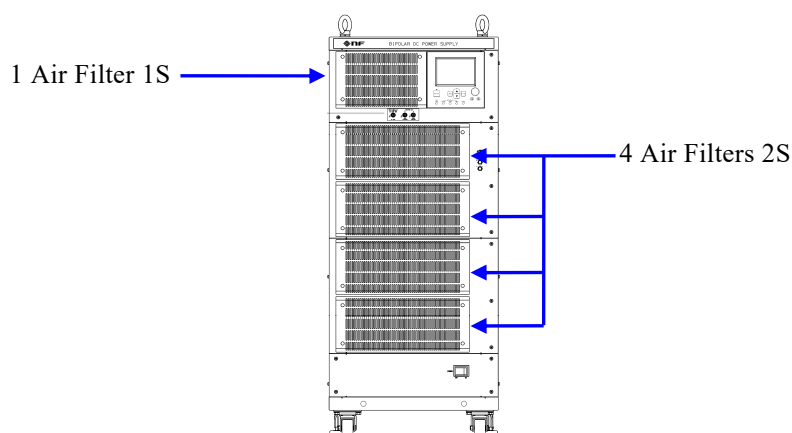

8.20 Output Voltage and Output Current Supply Ranges

The supply range differs depending on the positive and negative output voltage limiter settings (+Vo limit, -Vo limit).

The DC output range figures (Figures 8-2 to 8-5) show the relationship between the outputtable voltage and current for DC. These figures also show the outputtable ranges for the voltage and current including DC offset for AC of 500 Hz and lower.

The AC output range figures (Figures 8-6 to 8-9) show the relationship between the outputtable DC voltage and peak current. However, the maximum time interval during which the peak current can be output is 4 ms.

All values in these figures are for reference only.

The horizontal axes of the figures of DC and AC output range is the ratio (%) to the following current value.

Current I_o (at 100 %)

Item	BP4640	BP4650
Current I_o	40 A	50 A

8.20 Output Voltage and Output Current Supply Ranges

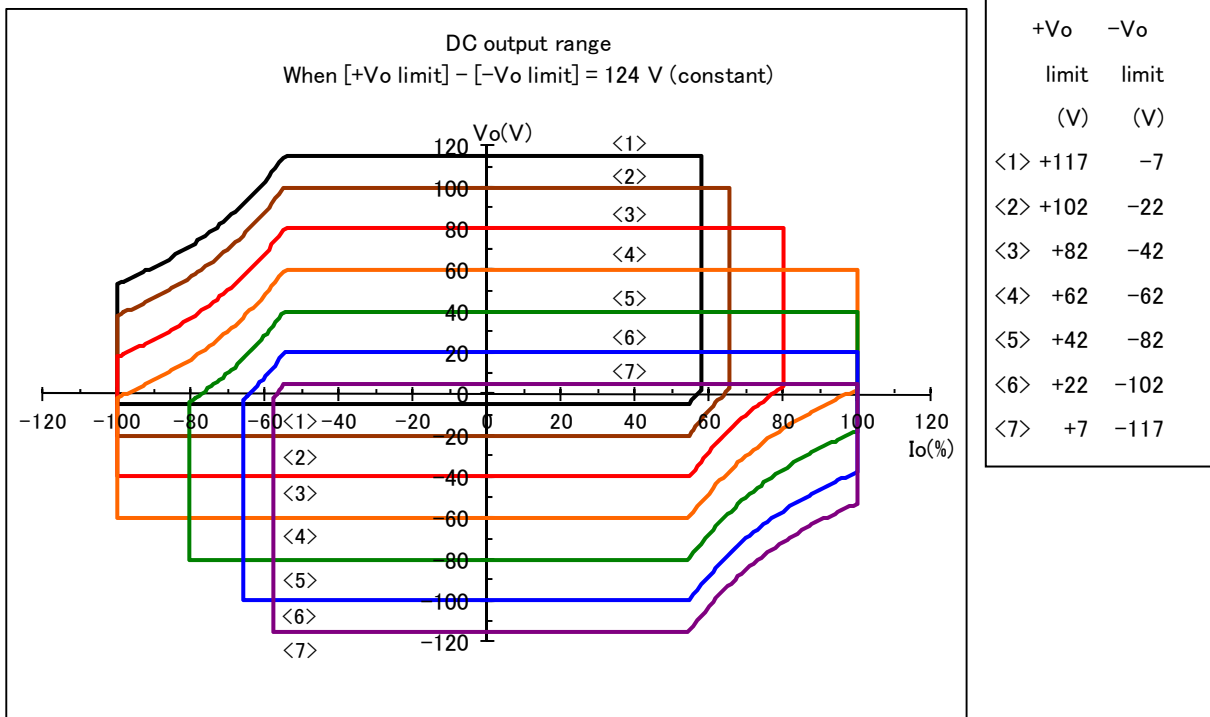

Figure 8-2. DC Output Range (When Positive/Negative Voltage Limiter Setting Difference Is Fixed to 124 V)

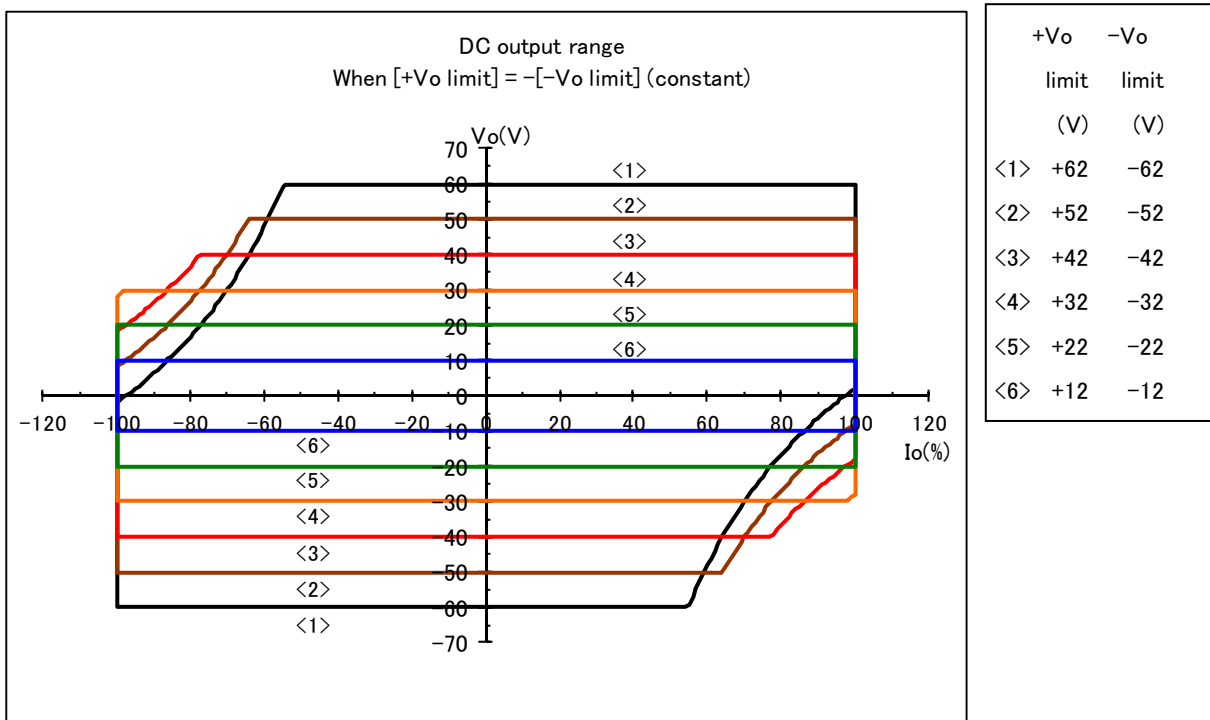

Figure 8-3. DC Output Range (When Positive/Negative Voltage Limiter Settings Are Symmetric)

8.20 Output Voltage and Output Current Supply Ranges

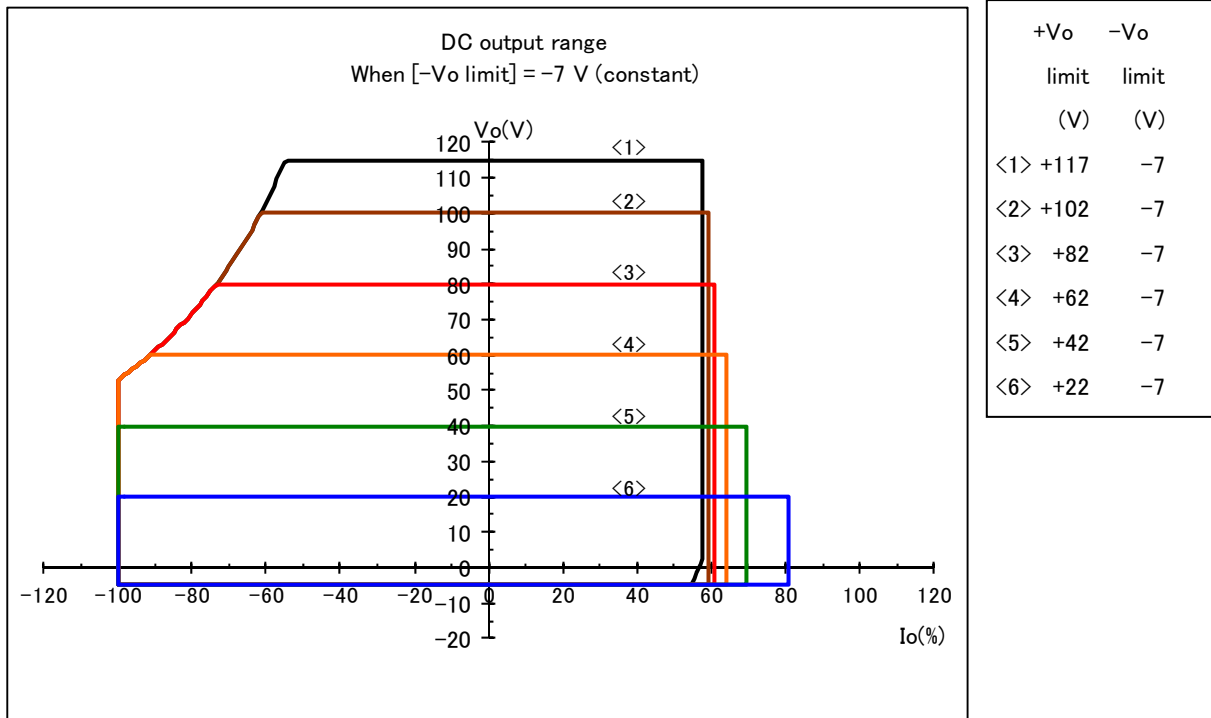

Figure 8-4. DC Output Range (When Negative Voltage Limiter Setting Is Fixed to -7 V)

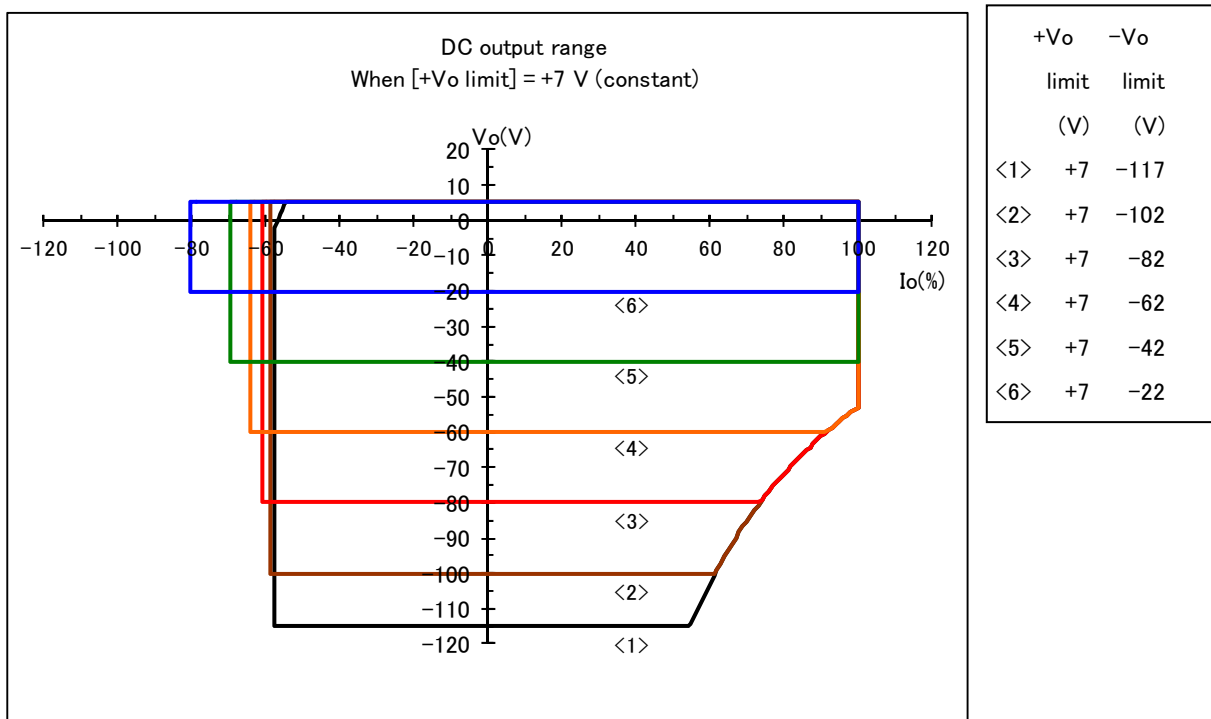

Figure 8-5. DC Output Voltage (When Positive Voltage Limiter Setting Is Fixed to $+7 \text{ V}$)

8.20 Output Voltage and Output Current Supply Ranges

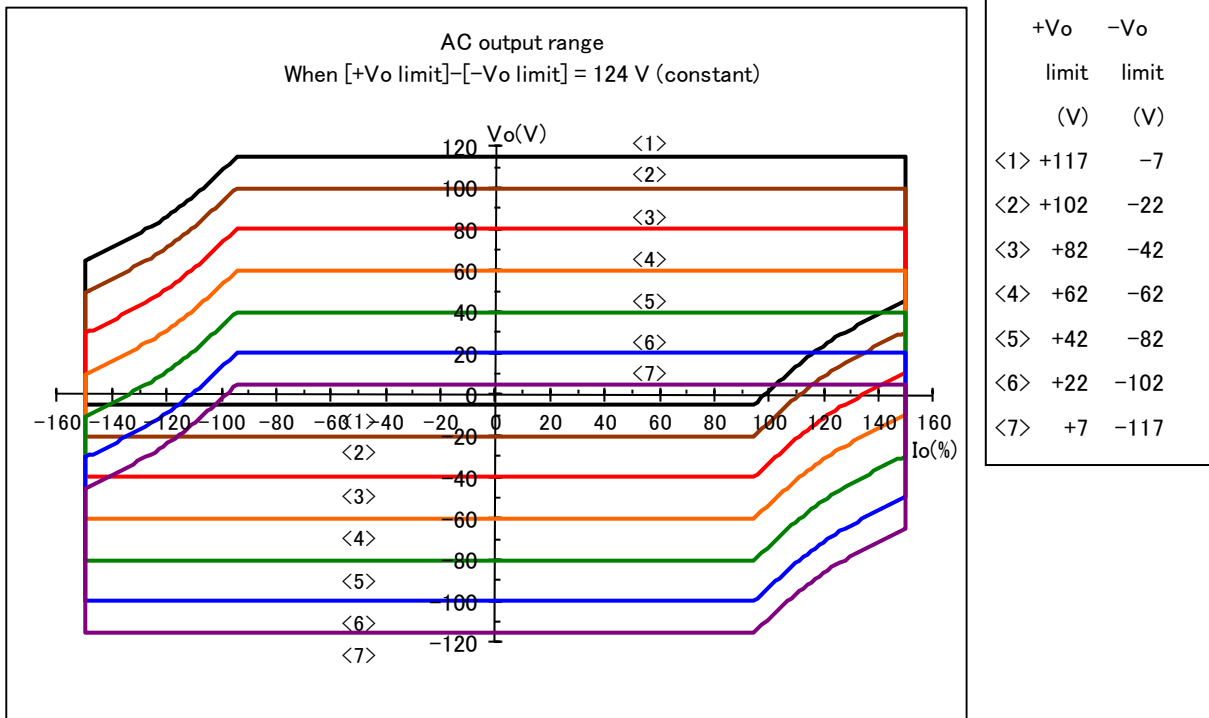

Figure 8-6. AC Output Range (When Positive/Negative Voltage Limiter Setting Difference Is Fixed to 124 V)

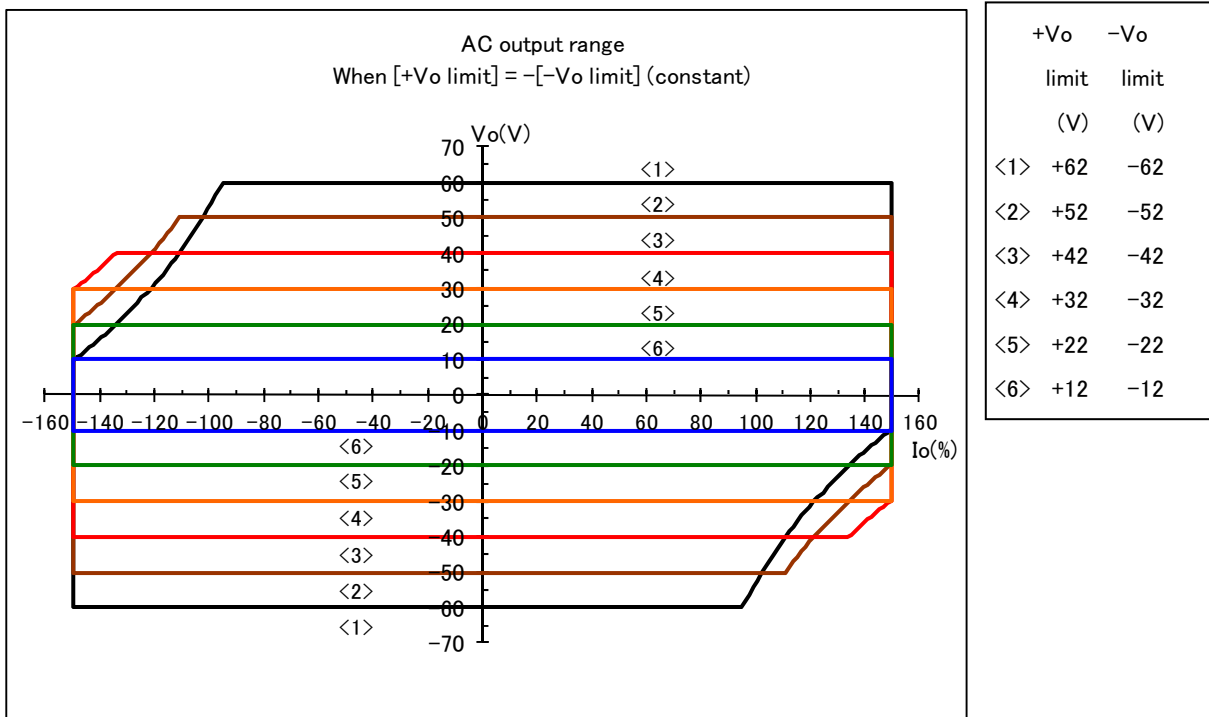

Figure 8-7. AC Output Range (When Positive/Negative Voltage Limiter Settings Are Symmetrical)

8.20 Output Voltage and Output Current Supply Ranges

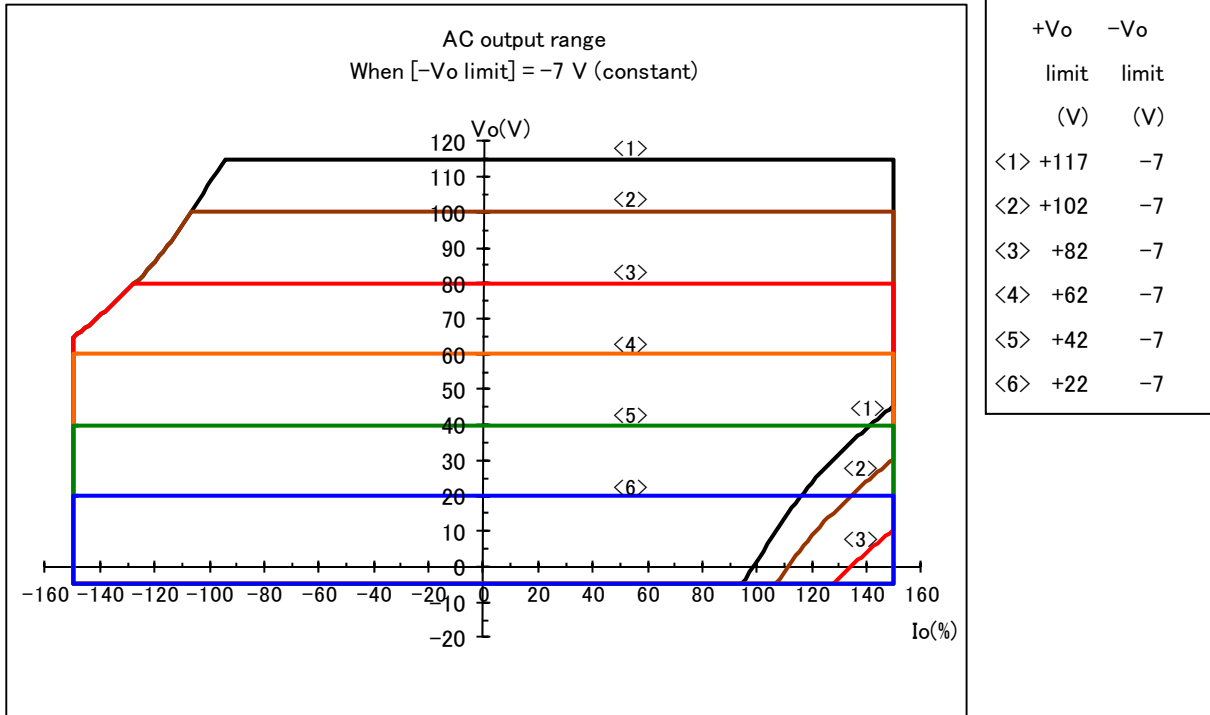

Figure 8-8. AC Output Range (When Negative Voltage Limiter Setting Is Fixed to -7 V)

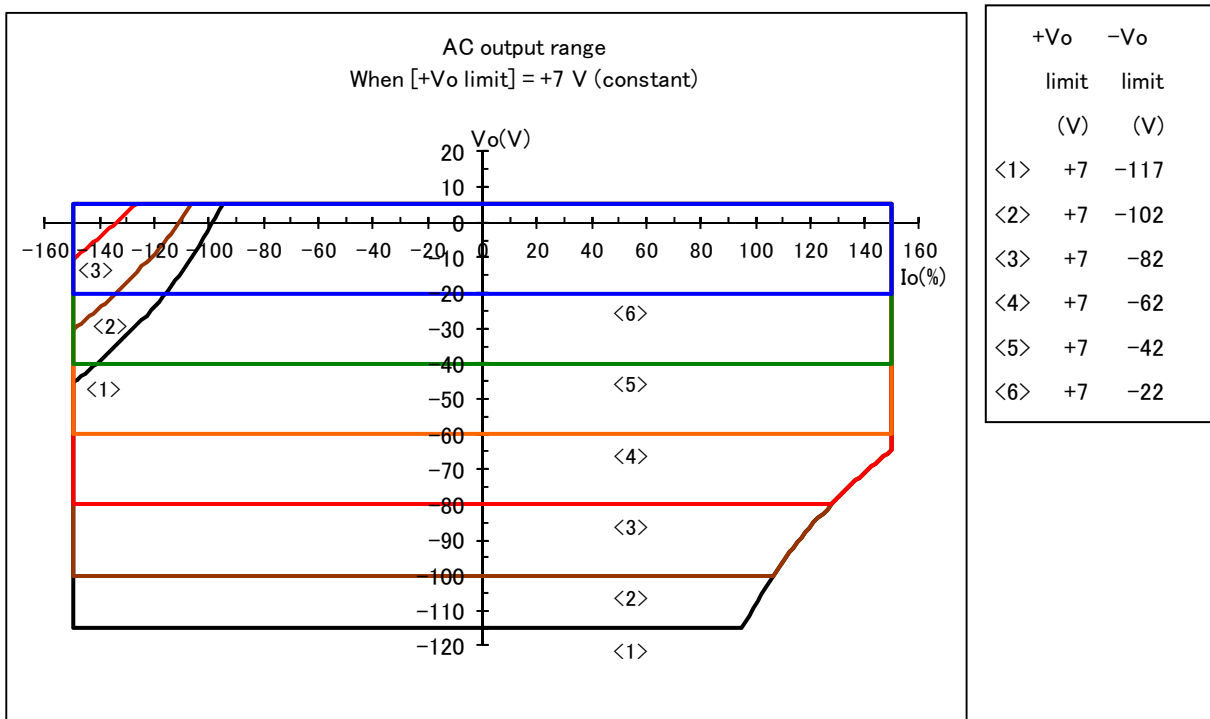

Figure 8-9. AC Output Range (When Positive Voltage Limiter Setting Is Fixed to $+7 \text{ V}$)

8.21 Drawing of External Dimensions

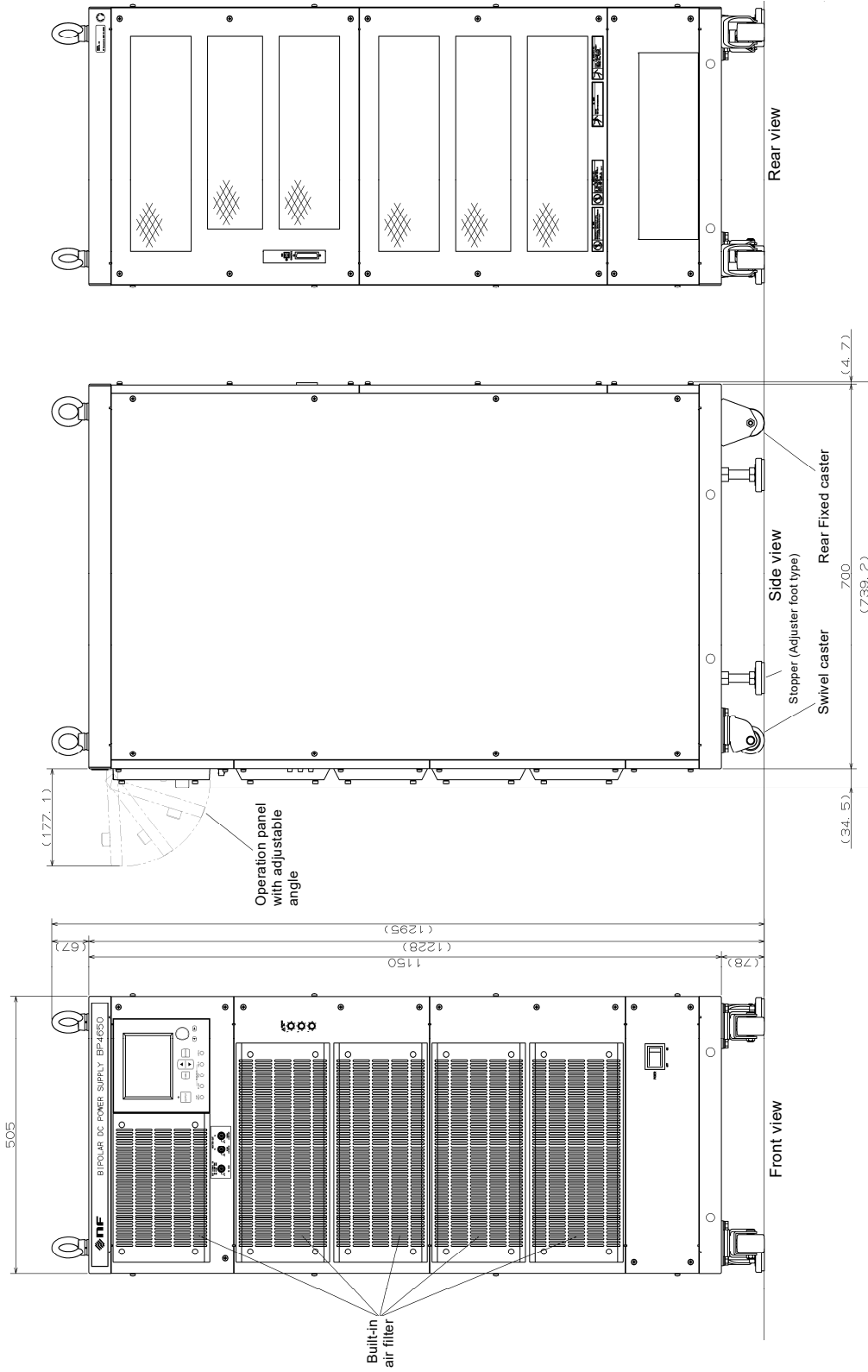

Figure 8-10. Drawing of External Dimension

9.INITIAL SETTING LIST

9.1 Initial Setting List9-2

9.1 Initial Setting List

“√” indicates the fact that the initial setting is applied. “-” indicates that the setting until now is maintained.

Table 9-1. Setting Memory

(1/2)

Setting Item	Initial Value	At Shipping	At Power-on	After Reset
Operation mode	CV-INT	√	Backup value	√
Output	OFF	√	Depends on output on/off setting at power-on	(Reset is possible only when output is off)
Response calibrator	OFF	√	Depends on response calibrator on/off setting at power-on	-
DC voltage	0.00 V	√	Backup value	√
DC current	0.00 A	√	Backup value	√
Superimposed AC voltage	0.0 Vp-p	√	Backup value	√
Superimposed AC current	0.0 Ap-p	√	Backup value	√
Frequency	50.0 Hz	√	Backup value	√
Waveform	SIN	√	Backup value	√
+ voltage limiter	62.0 V	√	Backup value	√
- voltage limiter	-62.0 V	√	Backup value	√
+ current limiter	104 A (BP4640) 130 A (BP4650)	√	Backup value	√
- current limiter	-104 A (BP4640) -130 A (BP4650)	√	Backup value	√
INTERFACE	USBTMC	√	Backup value	-
USB488 ID	2	√	Backup value	-
Keylock	OFF	√	Backup value	-
Beep	ON	√	Backup value	-
LCD contrast	55	√	Backup value	-
LCD display color	BLUE	√	Backup value	-
Frequency unit	Hz	√	Backup value	-
Time unit	s	√	Backup value	-
Output on/off at power-on	OFF	√	Backup value	-
Response calibrator on/off at power-on	OFF	√	Backup value	-
External control input enable/disable	DISABLE	√	Backup value	-

9.1 Initial Setting List

(2/2)

Setting Item	Initial Value	At Shipping	At Power-on	After Reset
Arbitrary waveform transmit/receive, control memory specification	2 (ARB1)	√	√	–
SRQ enable register	179	√	√	–
Standard event status enable register	255	√	√	–
Operation transition filter	0	√	√	–
Operation event enable register	20482	√	√	–
Warning event enable register	1	√	√	–
Overload transition filter	0	√	√	–
Overload event enable register	1	√	√	–
Header on/off	OFF	√	√	–

Table 9-2. Store/Recall Memory (All Memories)

Setting Item	Initial Value	At Shipping	At Power-on	After Clearing
Operation mode	CV-INT	√	Backup value	√
DC voltage	0.00 V	√	Backup value	√
DC current	0.00 A	√	Backup value	√
Superimposed AC voltage	0.0 Vp-p	√	Backup value	√
Superimposed AC current	0.0 Ap-p	√	Backup value	√
Frequency	50.0 Hz	√	Backup value	√
Waveform	SIN	√	Backup value	√
+ voltage limiter	62.0 V	√	Backup value	√
– voltage limiter	–62.0 V	√	Backup value	√
+ current limiter	104 A (BP4640) 130 A (BP4650)	√	Backup value	√
– current limiter	–104 A (BP4640) –130 A (BP4650)	√	Backup value	√

Table 9-3. Arbitrary Waveform Memory

Setting Item	Initial Value	At Shipping	At Power-on	After Clearing
ARB1 to ARB8	Sine wave data	√	Backup value	√
ARB9 to ARB12	Square wave data	√	Backup value	√
ARB13 to ARB16	Triangular wave	√	Backup value	√

9.1 Initial Setting List

Table 9-4. Sequence Memory (All Steps)

Setting Item	Initial Value	At Shipping	At Power-on	After Reset
Step number specification	1	√	√	–
Step time	0.1000 s	√	Backup value	√
DC voltage	0.00 V	√	Backup value	√
DC current	0.00 A	√	Backup value	√
DC voltage/current operation type	CONST	√	Backup value	√
Superimposed AC voltage	0.0 Vp-p	√	Backup value	√
Superimposed AC current	0.0 Ap-p	√	Backup value	√
Superimposed AC voltage/ current operation type	CONST	√	Backup value	√
Frequency	50.0 Hz	√	Backup value	√
Frequency operation type	CONST	√	Backup value	√
Waveform	SIN	√	Backup value	√
Waveform operation type	CONST	√	Backup value	√
Step sync output	0, 0	√	Backup value	√
Step sync output operation type	CONST	√	Backup value	√
Step end phase	DISABLE	√	Backup value	√
Step termination	STOP	√	Backup value	√
Jump step	0	√	Backup value	√
Jump count	1	√	Backup value	√
Branch step 0	0 (invalid)	√	Backup value	√
Branch step 1	0 (invalid)	√	Backup value	√

WARRANTY

NF Corporation certifies that this product was thoroughly tested and inspected and found to meet its published specifications when it was shipped from our factory. In the unlikely event that you experience an issue during use, please contact our company or agency of our company from which you purchased the product.

All NF products are warranted against defects in materials and workmanship for a period of one year from the date of shipment. During the warranty period, NF will repair the defective product without any charge for the parts and labor.

For repair service under warranty, the product must be returned to either NF or an agent designated by NF. The Purchaser shall prepay all shipping cost, duties and taxes for the product to NF from another country, and NF shall pay shipping charges to return the product to the purchaser.

This warranty shall not apply when corresponding to following particulars.

- A) Failure caused by improper handling or use of the product in a manner that does not conform with the provisions of the Instruction Manual.
- B) Failure or damage caused by transport, dropping, or other handling of the product after purchase.
- C) Failure caused by repair, adjustment, or modification of the product by a company, organization, or individual not approved by NF.
- D) Failure caused by abnormal voltage or the influence of equipment connected to this product.
- E) Failure caused by the influence of supply parts from the customer.
- F) Failure caused by such as corrosion that originate in the use of causticity gas, organic solvent, and chemical.
- G) Failure caused by the insect or small animal that invaded from the outside.
- H) Failure or damage caused by fire, earthquakes, flood damage, lightning, war, or other uncontrollable accident.
- I) Failure caused by the reason that was not able to be foreseen by the science and technology level when shipped from our company.
- J) Replacement and replenishment of consumables such as batteries.

NF Corporation

WABUN(DA00059420-004)

If there are any misplaced or missing pages, we will replace the manual. Contact the sales representative.

NOTES:

- Reproduction of the contents of this manual is forbidden by applicable laws.
- The contents of this manual may be revised without notice.
- Information provided in this manual is intended to be accurate and reliable. However, we assume no responsibility for any damage regarding the contents of this manual.
- We assume no responsibility for influences resulting from the operations in this manual.

Copyright 2017-2022, **NF Corporation**

BP4640 / BP4650 Instruction Manual

NF Corporation

6-3-20, Tsunashima Higashi, Kohoku-ku, Yokohama

223-8508 JAPAN

Phone +81-45-545-8128 Fax +81-45-545-8187

