

---

**User's  
Manual**

**AQ2200 Series  
Multi Application Test System  
Frame and Module Operation**

---

Thank you for purchasing this AQ2200 Series Multi Application Test System. This user's manual explains the features, operating procedures, and handling precautions of the AQ2200 Series. To ensure correct use, please read this manual thoroughly before operation. Keep this manual in a safe place for quick reference in the event a question arises.

## List of Manuals

The following manuals, including this one, are provided as manuals for the AQ2200 Series. Please read all manuals.

Manual Title	Manual No.	Description
AQ2200 Series Multi Application Test System User's Manual Startup Guide	IM 735101-01EN	The supplied CD contains the PDF file of this manual. This manual describes the handling precautions for, the names and functions of all parts of, and the firmware upgrade procedure for the AQ2200 Series.
AQ2200 Series Multi Application Test System Frame and Module Operation User's Manual	IM 735101-03EN	This manual. The supplied CD contains the PDF file of this manual. This manual describes all the features of the AQ2200 Series and how to use them, with the exception of some of the application and communication features.
AQ2200 Series Multi Application Test System Application Operation User's Manual	IM 735101-04EN	The supplied CD contains the PDF file of this manual. This manual describes the AQ2200 Series application features and how to use them.
AQ2200 Series Multi Application Test System Communication Interface User's Manual	IM735101-17EN	The supplied CD contains the PDF file of this manual. This manual describes the AQ2200 Series communication interface features and how to use them.
64 Mbit Program Pattern Option User's Manual	IM 810518801-61E	This manual describes how to create program patterns for the AQ2200-601 10 Gbit/s BERT module with the /M option.
SDH/SONET Frame Option User's Manual	IM 810518801-62E	This manual describes how to create SDH/SONET patterns for the AQ2200-601 10 Gbit/s BERT module with the /P1 option.
AQ2200 Series Modules Checking the Contents of the Package and Handling Precautions of the Modules	IM 810518901-04E	This is included with AQ2200 Series modules. It explains the handling precautions of the module and lists the package contents.
Connector Adapter for Multi-Fiber Cable User's Manual	IM AQ9340-01EN	This manual explains the handling precautions of the connector adapters and how to use them.

The "EN" and "E" in the manual numbers are the language codes.

Contact information of Yokogawa offices worldwide is provided on the following sheet.

Manual No.	Description
PIM 113-01Z2	List of worldwide contacts

---

## Notes

- The contents of this manual are subject to change without prior notice as a result of continuing improvements to the instrument's performance and functions. The figures given in this manual may differ from those that actually appear on your screen.
- Every effort has been made in the preparation of this manual to ensure the accuracy of its contents. However, should you have any questions or find any errors, please contact your nearest YOKOGAWA dealer.
- Copying or reproducing all or any part of the contents of this manual without the permission of YOKOGAWA is strictly prohibited.

## Trademarks

- Adobe and Acrobat are registered trademarks or trademarks of Adobe Systems Incorporated.
- Microsoft and Windows are registered trademarks or trademarks of Microsoft Corporation in the United States and/or other countries.
- In this manual, the ® and TM symbols do not accompany their respective registered trademark or trademark names.
- Other company and product names are registered trademarks or trademarks of their respective holders.

## Revisions

- 1st Edition: August 2009
- 2nd Edition: November 2009
- 3rd Edition: January 2010
- 4th Edition: November 2012
- 5th Edition: September 2014
- 6th Edition: December 2014
- 7th Edition: May 2015
- 8th Edition: November 2015
- 9th Edition: May 2017
- 10th Edition: October 2017
- 11th Edition: February 2018
- 12th Edition: September 2018
- 13th Edition: February 2019
- 14th Edition: September 2020

---

# Conventions Used in This Manual

## Notes and Cautions

The notes and cautions in this manual are categorized using the following symbols.



*Improper handling or use can lead to injury to the user or damage to the instrument.* This symbol appears on the instrument to indicate that the user must refer to the user's manual for special instructions. The same symbol appears in the corresponding place in the user's manual to identify those instructions. In the manual, the symbol is used in conjunction with the word "WARNING" or "CAUTION."

### **WARNING**

Calls attention to actions or conditions that could cause serious or fatal injury to the user, and precautions that can be taken to prevent such occurrences.

---

### **CAUTION**

Calls attentions to actions or conditions that could cause light injury to the user or damage to the instrument or user's data, and precautions that can be taken to prevent such occurrences.

## French

### **AVERTISSEMENT**

Attire l'attention sur des gestes ou des conditions susceptibles de provoquer des blessures graves (voire mortelles), et sur les précautions de sécurité pouvant prévenir de tels accidents.

---

### **ATTENTION**

Attire l'attention sur des gestes ou des conditions susceptibles de provoquer des blessures légères ou d'endommager l'instrument ou les données de l'utilisateur, et sur les précautions de sécurité susceptibles de prévenir de tels accidents.

### **Note**

Calls attention to information that is important for proper operation of the instrument.

## Character Notations

Bold characters in procedural explanations are used to indicate panel keys and soft keys that are used in the procedure and menu items that appear on the screen.

---

# Contents

List of Manuals.....	i
Conventions Used in This Manual .....	iii
<b>Chapter 1 Explanation of Features</b>	
1.1 Frame Control Features .....	1-1
1.2 Light Source Function .....	1-5
1.3 Optical Sensor Function .....	1-13
1.4 Variable Attenuator Function .....	1-20
1.5 Optical Switch Function.....	1-21
1.6 BERT Function .....	1-22
1.7 Optical Modulator Function .....	1-44
1.8 Optical Receiver Function .....	1-48
1.9 XFP Interface Functions.....	1-51
1.10 Reference Clock Features (SG).....	1-52
1.11 Transceiver Interface Features.....	1-53
<b>Chapter 2 Basic Display Operations</b>	
2.1 Changing Displays .....	2-1
2.2 Changing the Module to Control (The current module).....	2-2
2.3 Selecting Parameters and Changing Values .....	2-4
2.4 Inputting a Character String .....	2-9
<b>Chapter 3 Optical Power Measurement</b>	
3.1 Power Measurement by Optical Sensor Module .....	3-1
<b>Chapter 4 Optical Output at a Fixed Wavelength</b>	
4.1 Configuring the DFB-LD Module and LS Module (AQ2200-112).....	4-1
4.2 Configuring the FP-LD Module.....	4-16
4.3 Configuring the DUAL FP-LD Module .....	4-25
<b>Chapter 5 Optical Output with Variable Wavelength (For CWDM)</b>	
5.1 Sets the Tunable Laser Source (TLS Module) .....	5-1
5.2 Executes the Sweep.....	5-25
5.3 Trigger Output .....	5-33
5.4 Others.....	5-38
<b>Chapter 6 Optical Output with Variable Wavelength (For DWDM: C-band and L-band)</b>	
6.1 Configuring the Grid Wavelength Light Source (Grid TLS Module).....	6-1
<b>Chapter 7 Optical Output Attenuation</b>	
7.1 Attenuation by ATTN Module.....	7-1
7.2 Attenuation Using an ATTN Module with a Built-in Monitor Power Meter.....	7-7
<b>Chapter 8 Change the Optical Measurement Connection Route</b>	
8.1 Change the Connection Route by OSW Module.....	8-1

<b>Chapter 9 BER Measurement</b>		<b>1</b>
9.1 Basic Operating Procedures for BERT Module .....	9-1	
9.2 10 Gbit/s BERT Module .....	9-2	
9.3 10 Gbit/s Optical Modulator Module .....	9-57	<b>2</b>
9.4 10 Gbit/s Optical Receiver Module .....	9-68	
<b>Chapter 10 155M/622M Clock Output</b>		<b>3</b>
10.1 SG Module .....	10-1	
<b>Chapter 11 Testing a 10G Transceiver</b>		<b>4</b>
11.1 XFP Interface Module .....	11-1	
11.2 Transceiver I/F Module .....	11-14	
<b>Chapter 12 Saving, Loading and Deleting the Measurement Conditions</b>		<b>5</b>
12.1 Keys and Displays Used for Operation .....	12-1	
12.2 Saving Setup Data, Measured Data, and Screen Captures .....	12-3	
12.3 Loading Setup Data and Macros .....	12-9	
12.4 Deleting the File .....	12-16	
12.5 Copying Files .....	12-17	<b>6</b>
12.6 Creating Directories .....	12-18	
12.7 Editing File and Directory Names .....	12-19	
<b>Chapter 13 Setting the System</b>		<b>7</b>
13.1 Setup Screen .....	13-1	
13.2 Configuring GP-IB Settings .....	13-2	
13.3 Configuring Ethernet Settings .....	13-3	<b>8</b>
13.4 Locking the Laser Output .....	13-4	
13.5 Configuring the Display and the Volume .....	13-8	
13.6 Setting the Date and Time .....	13-10	
13.7 Displaying Device Information .....	13-11	<b>9</b>
13.8 Returning the Initial Settings .....	13-18	

**Index**



## 1.1 Frame Control Features

### Saving and Loading

You can use this feature to save and load the settings of the frame and its modules.  
By using the application features, you can save measured results to CSV files.  
You can also save screen shots as files.

### System Settings

#### Password Setting

You can use this feature to specify a four-digit number to use as a password for locking and unlocking laser output.

#### Device Information Display

This display shows information about the frame controller.  
You can use the keys to show information about the frame controller on the screen.

#### Installed Module Information

You can use this feature to detect and display the modules installed in each slot.  
You can use the keys to show information about a specific module on the display.  
Some items are displayed for every module, while some items are only displayed for individual modules.

#### Firmware Version List

You can use this feature to display the firmware versions of the frame controller and the modules installed on it.  
You can use the keys to show a list of the firmware versions of the frame controller and the modules installed on it.

#### Laser Output Lock

You can use this feature to only allow certain users to turn laser output on and off.  
You need to enter a password to turn the lock on or off.

#### Device Status Check

You can use this feature to check the status of the frame controller (fan condition) and view pass/fail evaluations of that status.

#### Error History Display

When an error occurs, you can display the error history.

## 1.1 Frame Control Features

---

### Initialization

You can use this feature to restore the settings to their default values.

You can select one of the following types of initialization:

- Reset all the settings for the entire system to their default values.
- Only reset the settings for the frame controller to their default values.
- Reset the settings for all the installed modules to their default values.
- Only reset the settings for the selected module to their default values.

### Update

You can use this feature to update firmware, and module firmware.

### Multi-User Feature

You can simultaneously connect the AQ2200 to up to seven PCs. The types of connections that can be made are as follows:

- One USB connection
- One GP-IB connection
- Five Ethernet connections

There is no hierarchy between the up to seven PCs that you can connect.

The frame controller responds to commands and queries from the PCs in the order that they are received.

### Note

---

When multiple PCs are connected, it is up to the user to take measures to prevent signals from conflicting with and blocking each other.

---

### Interlock Connector

An interlock connector is provided as a laser output safety device. When this connector is open (i.e. the connector is unconnected), the OPT LOCK status is set and the light source module cannot emit a laser beam.

### Note

---

When the interlock connector is open, "Lock" is displayed in the "Opt" field on the Light Source modules and XFP Interface module (XFP transceiver installed).

---

### Unlocking the Interlock Function

Connect the included Interlock Connector Plug (A1288JA) to the REMOTE INTERLOCK terminal on the back of the unit. For details on how to release the interlock and output a laser beam, see section 2.9 "Unlocking the Laser Output" in [Startup Guide] (IM 735101-01EN).



**GP-IB Connector**

A GP-IB interface is provided as a standard accessory.

This enables setting/changing of various parameters and transfer of data via the GP-IB bus.

An IEEE-488 compatible receptacle connector is used for this interface.

**Note**

- The total length of connecting cables must be 20 m or shorter.
- The length of each cable between devices must be 2 m or shorter.
- The number of devices connected at the same time to the interface must be 15 or smaller (the number of devices that are turned ON must be 10 or smaller).

**Trigger-in Connector/Trigger-out Connector**

The sensor measurement start signal can be input/output using these connectors.

All the modules installed in the frame controller can receive this signal at the same timing.

Connector: BNC

Trigger-in: TTL level input

Input impedance approx. 5 k $\Omega$

Input pulse width 50  $\mu$ s or longer

Trigger-out: TTL level out

Output impedance approx. 100  $\Omega$

Output pulse width approx. 50  $\mu$ s

**USB Memory**

As a USB memory device is connected to the USB interface connector (Type A) on the front panel of this unit, you can use it as a data saving memory.

**Operating Conditions**

Item	Operating Conditions
Specifications	USB2.0 Applicable to USB Mass Storage Class
Supply current	500 mA

Yokogawa does not guarantee normal operation of all the USB memory devices on the market.

## Ethernet Communication

This unit can be controlled remotely from a PC using communication commands via Ethernet port.

### Ethernet Communication Specifications

Number of communication ports:	1
Electrical/mechanical specifications:	Conforms to IEEE802.3.
Transmission method:	Ethernet (100BASE-TX)
Transmission speed:	Max. 100 Mbps
Communication protocol:	TCP/IP
Connector:	RJ-45

### Connecting Method

Connect the unit to the PC as shown below.

#### Connecting to PC via Network

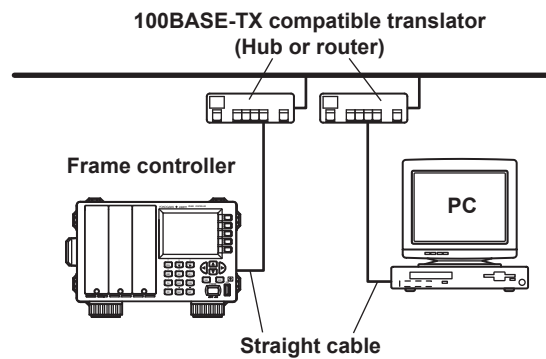

#### Connecting to PC via Hub

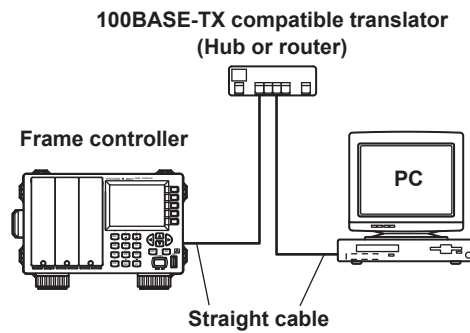

### Note

- If the unit is connected to the PC with a cross cable, it normally operates without problems, however, there is a possibility of improper operation because this connecting method is not supported by Ethernet requirements. In this case, connect them using straight cables and a hub.
  - The total length of the cables must be 3 m or shorter.
-

## 1.2 Light Source Function

### Sets the Optical Output Level (DFB-LD Module, LS Module, FP-LD Module, or Grid TLS Module)

With the DFB-LD module (AQ2200-111), LS module (AQ2200-112), FP-LD module (AQ2200-141, AQ2200-142), or Grid TLS module (AQ2200-131, AQ2200-132) you can output the laser beam by specifying an absolute power value.

The following shows the relationship among the laser beam output power, attenuation amount, and power offset value.

$$PL \text{ (dBm)} = P \text{ default (dBm)} - \text{ATTN(dB)}$$

$$P \text{ display (dBm)} = PL \text{ (dBm)} + PL \text{ Offset (dB)}$$

where

PL: Laser output power (dBm)

P display: Output power display value (dBm)

P default: Maximum output power at shipment (dBm)

ATTN: Attenuation amount (dB) (See Attenuating the Optical Output (page 4-5).)

PL Offset: Power offset value (dB) (See Changing the Offset of the Display Output Power (page 4-6).)

#### Note

- The PL offset function is not available on the LS module (AQ2200-112). Power offset value is always zero.
- The connector connection status, environment, and/or secular change may affect the P default. Therefore, the values set in Pdisplay are not guaranteed. These values are used as reference.
- The LS module (AQ2200-112) is supported on firmware version (FIRM VER) 3.08 and later.
- Grid TLS modules (AQ2200-131/132) are supported on firmware version (FIRM VER) 3.00 and later (3.06 and later if the suffix code is -T6).

### Setting the Power (TLS Module)

The following shows the Power of this unit and the adjustable range.

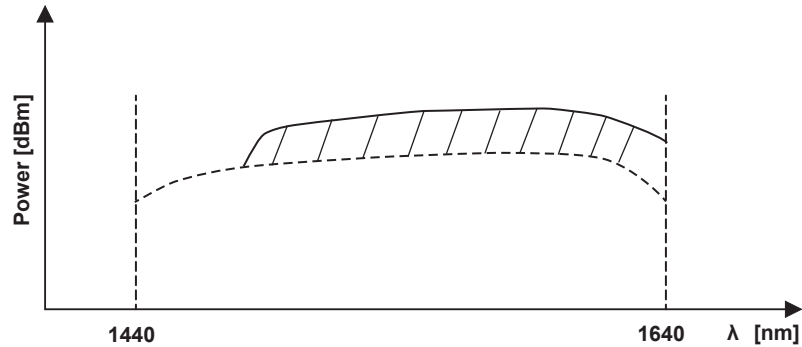

Solid line: Maximum power of each wavelength  
 Shading range: The Power variable change range of each wavelength  
 Dashed line: Minimum power of each wavelength

- Setting a desired power (Manual)**  
 In the shading range shown above, the power of each wavelength can be set in steps of 0.1 dB. This power is different from that set for each TLS module. Additionally, this power becomes the fixed output close to a range of 1440 to 1480 nm, which cannot be changed variably, according to the type of the module.
- Auto detection function of maximum power at a desired wavelength (Max)**  
 This function automatically detects the maximum power value of each wavelength shown by the solid line in the Fig. above.
- Auto detection function of power during sweep (Sweep Max)**  
 In the detection of the power during sweep, the power of each wavelength is lowered so that it is close to the wavelength having the lowest power in the wavelength range to be swept. This detection function is intended to make the power as constant as possible within the sweep wavelength range since this unit has the output characteristics shown in the Fig. above.

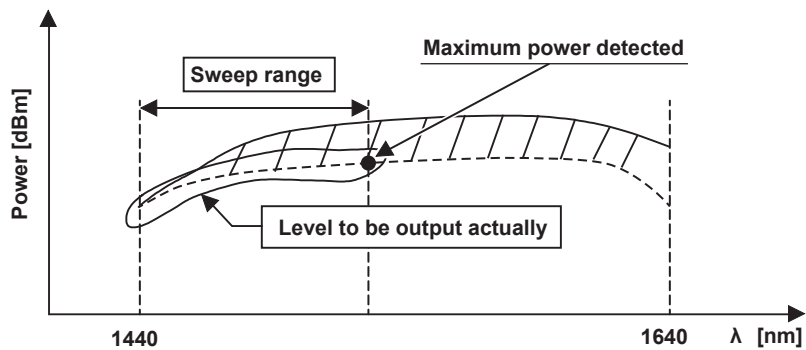

## Changing the Wavelength (DFB-LD Module)

You can change the laser output wavelength within a width of approximately 1.6 nm in steps of 1/1000 nm. The display wavelength has the following relationship.

$$\lambda \text{ display (nm)} = \lambda \text{ output (nm)} + \text{WL Offset (nm)}$$

$$f \text{ (THz)} \times 10^{12} = c / (\lambda \text{ display (nm)} \times 10^{-9})$$

where

$\lambda$  display: Display wavelength (nm)

$\lambda$  output: Output wavelength (nm)

WL Offset: Wavelength offset value (nm)

f: Display frequency (THz)

c: Light velocity in vacuum (2.99792458 x 10<sup>8</sup> m/s)

### Note

- For details about WL Offset, see Changing the Wavelength Offset (page 4-9).
- The currently set wavelength position to the allowable wavelength setting range can be checked using the wavelength bar on the DETAIL screen. This data is used as reference of the wavelength setting.

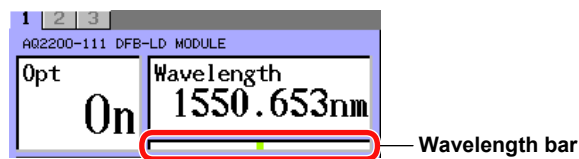

## Setting the Wavelength (TLS Module)

The wavelength can be set in the following range.

Range: 1440.000 to 1640.000 nm

## Changing the Frequency (Wavelength) (Grid TLS Module)

This feature is supported on firmware version (FIRM VER) 3.00 and later (3.06 and later if the suffix code is -T6). The feature supports C-Band and L-Band that are used in WDM and other communications. The frequency can be set in 25GHz steps (when the suffix code is -T2, -T6) or in 50 GHz steps (when the suffix code is -T4). If the suffix code is -T2 or -T6, the frequency can be fine-tuned ( $\pm 6$  GHz).

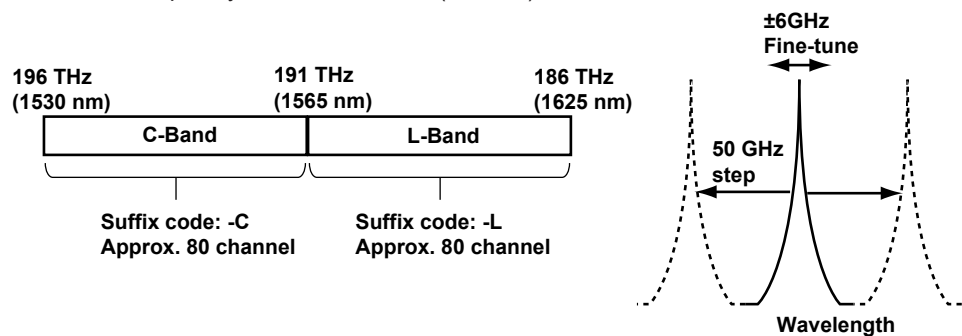

The frequency can be set in the following ranges. You can also change the unit to nm and set the value in terms of the wavelength.

Suffix code	-T2, -T6	C-Band	196.25 to 191.50 THz (1527.60 to 1565.50 nm)
		L-Band	190.95 to 186.35 THz (1570.01 to 1608.76 nm)
-T4	C-Band	196.10 to 191.70 THz (1528.77 to 1563.86 nm)	
	L-Band	190.90 to 186.50 THz (1570.42 to 1607.47 nm)	

## Coherence Control (DFB-LD, LS (AQ2200-112), and TLS Modules)

If the interference between the measurement system and object device to be measured may adversely affect the unit when starting the measurement, the output line width can be controlled by modulating the output light to relax the effects of the interference.

Wide: By modulating "Narrow", the light having low coherency is output.

Narrow: Light having high coherency is output.

### Modulating Laser Output (DFB-LD and FP-LD Modules)

You can perform the CW (continuous light) or CHOP (DUTY 50% ) modulation of the optical output.

For CHOP modulation, 270 Hz, 1 kHz, or 2 kHz can be set.

### Light Source External Modulation Input (DFB-LD Module)

The light source external modulation input is supported only by the external modulation option of the DFB-LD module (AQ2200-111). A signal satisfying the following requirements must be input to the external modulation input connector located on the front panel of the AQ2200-111.

- **When the external sine modulation option is selected**

Connector:	SMA
Input impedance:	Approx. 50 $\Omega$
Maximum input voltage:	2 Vp-p
Frequency:	100 Hz to 300 kHz

- **When the external CHOP modulation option is selected**

Connector:	SMA
Input impedance:	Approx. 2 k $\Omega$
Maximum input voltage:	TTL Level
Frequency:	100 Hz to 300 kHz

### Calibrating the Output Wavelength (TLS Module)

#### Block Diagram

This unit calibrates the wavelength using the built-in gas cell.

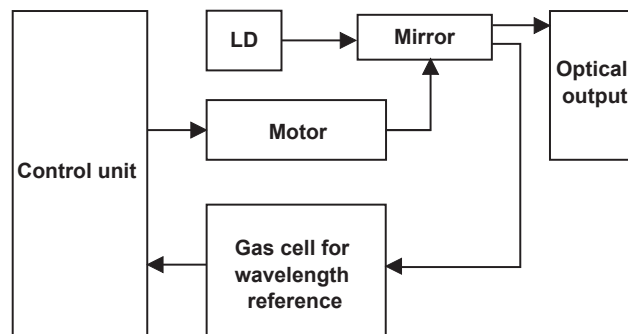

#### Warming Up

The major leading particulars of this unit are specified in the status that the wavelength calibration is executed with the inside temperature of the unit kept stable. It is required to perform the warm-up operation for 1 hr. or longer until the temperature becomes stable from OPT-ON after the power has been turned ON under reference operation conditions (ambient temperature: 23 $\pm$ 2 $^{\circ}$ C). Therefore, you must wait until the warm-up operation is completed.

#### Note

When operating the unit before completion of warming up, variations in wavelength and/or power may occur. Additionally, when restarting the operation immediately once the power has been turned OFF, it is not necessary to warm up the unit for 1 hr. or longer. However, how the temperature inside the unit lowers may vary depending on the ambient temperature conditions. Therefore, the warm-up time for such operation is not specified.

## Sweep Function (TLS Module)

This sweep function variably changes the wavelength within the specified wavelength range according to the set conditions. This function is used to measure the characteristics when each wavelength transmits through the object device to be measured, such as wavelength transmission characteristics and/or wavelength dependent loss characteristics.

An optimal sweep method can be selected from four sweep methods according to the measurement method.

- Manual sweep: The sweep is stopped temporarily at every specified wavelength step in the step sweep.
- Step sweep: The wavelength is changed variably while waiting for a specified period of time at every specified wavelength step.
- Continuous sweep: The wavelength is changed variably in the wavelength range.
- Trigger sweep: This trigger sweep is used to perform the measurement with the sweep while synchronizing with the external measuring instrument using the hardware trigger signal.

### Manual Sweep

After the sweep has been started, the wavelength is moved to the next wavelength within the set wavelength range (wavelength 1 to wavelength n) by operating the button. Only one sweep sequence is performed. Therefore, the sweep is completed when the measurement is performed until the set end wavelength (wavelength "n").

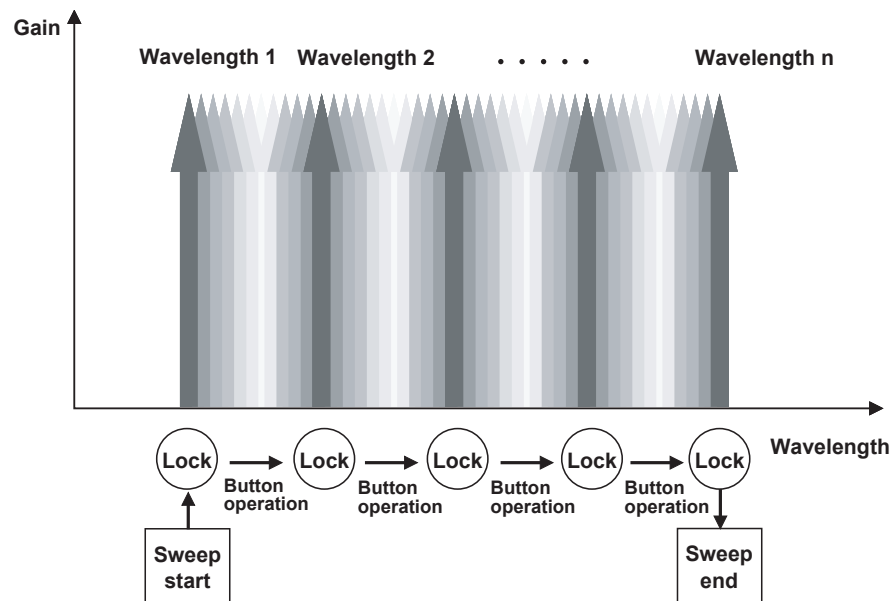

Images of Manual Sweep

**Step Sweep**

After the sweep has been started, the wavelength is moved to the next wavelength at intervals of set wavelengths within the set wavelength range (wavelength 1 to wavelength n). Only one sweep sequence is performed. Therefore, the sweep is completed when the output is performed until the set end wavelength.

When using other company's OPM (Optical Power Meter), the trigger output mode described in section 5.3 is set to "Step Finished" that outputs the trigger at the end of the step sweep in order to make the synchronization.

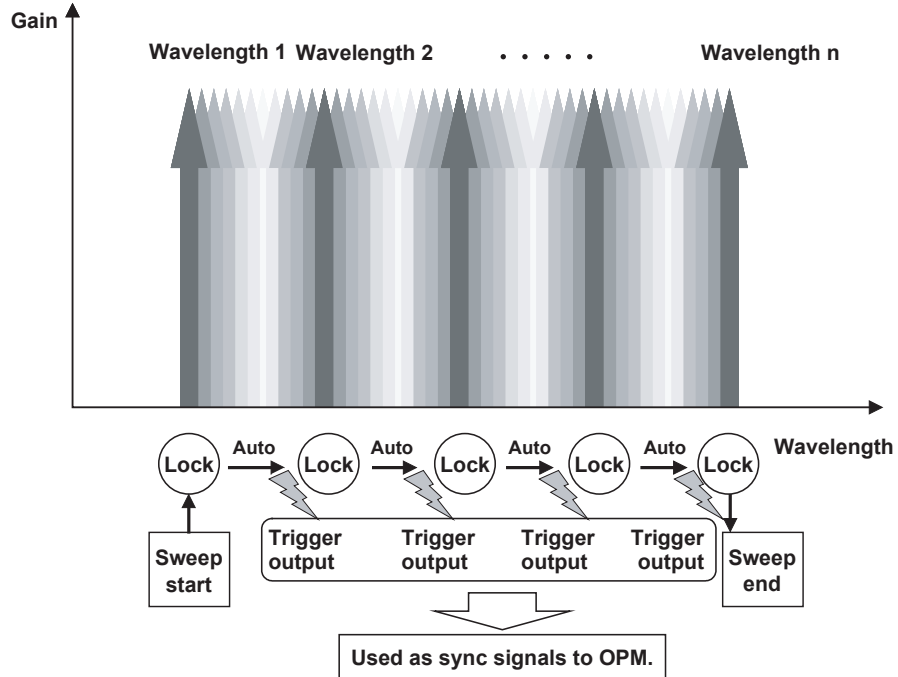

Images of Step Sweep

**Continuous Sweep**

After the sweep has been started, the wavelength is moved to the next wavelength at intervals of set wavelengths within the set wavelength range. In the continuous sweep, the wavelength is not locked, but the trigger is output at set sweep intervals. The trigger output mode described in section 5.3 is set to "Sweep Finished" that outputs the trigger at the end of the sweep. The synchronization with externally connected OPM unit can be made.

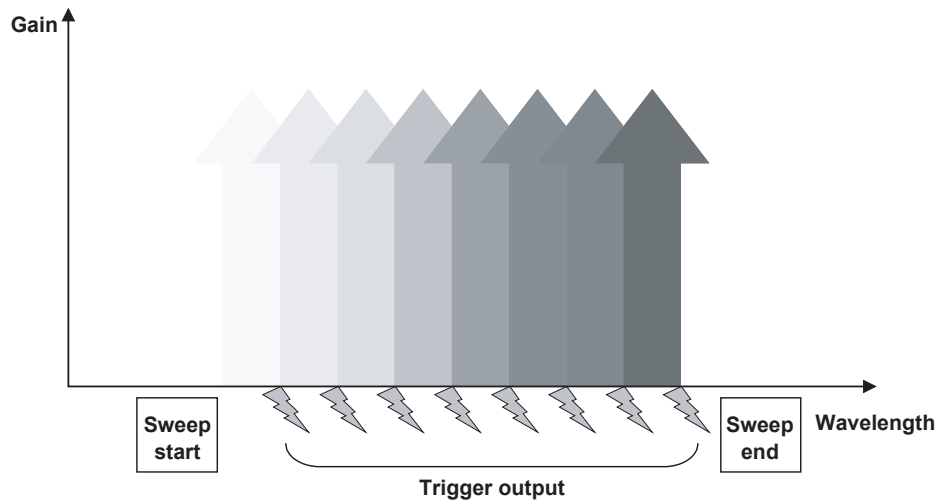

Images of Continuous Sweep



### Trigger Sweep

The sweep is started by the external/internal trigger within the set wavelength range (wavelength 1 to wavelength n). After the sweep has been started, the wavelength is moved to the next wavelength at intervals of set wavelengths. Only one sweep sequence is performed. Therefore, the sweep is completed when the output is performed until the set end wavelength.

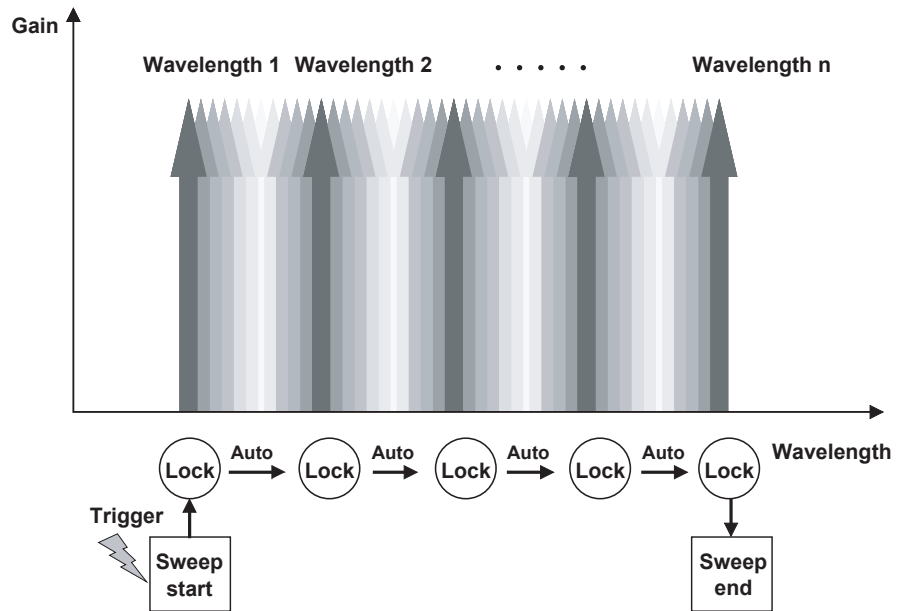

Images of Sweep Start by Trigger Input

## 1.2 Light Source Function

### Trigger Output

A trigger can be output each time the sweep conditions specified in advance are executed. With this trigger output, you can add the AQ6370C Optical Spectrum Analyzer (OSA) and measure wavelength transmission characteristics through synchronous sweep measurement. This makes it possible to measure the high dynamic range, such as narrow bandwidth BEF (Band-Elimination-Filter).

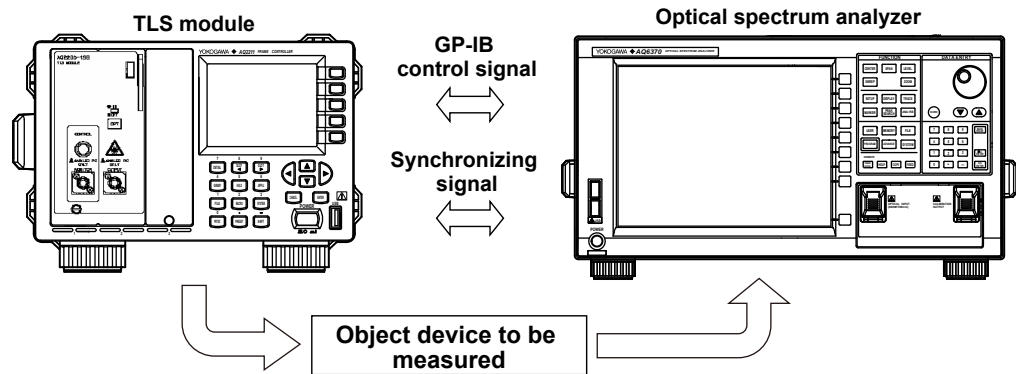

You can configure a synchronous sweep system consisting of TLS module and optical spectrum analyzer with AQ6370C and without use of personal control.

### Note

When performing the synchronous sweep with the OSA, the wavelength range becomes 1440 to 1640 nm.

### Dither Function (Grid TLS Module Suffix Code: -T2)

This feature is supported on firmware version (FIRM VER) 3.00 and later.

This feature suppresses Stimulated Brillouin Scattering (SBS) by using sinusoidal modulation.

The following sinusoidal modulation is performed.

AM amplitude (Dither A): 0 to 2%

SBS suppression frequency (Dither F): 0 to 1000 MHz

## 1.3 Optical Sensor Function

### Reference Function

When measuring optical output level, the level can vary depending on the light source and measuring system (depending on the wavelength). Therefore when measuring the loss level of the DUT, you can set the optical output level of the light source and measuring system as a reference value ahead of time, and then display the difference (the relative value) between the reference value and the actual measured value (absolute value) for the measured results.

You can switch the display between relative and absolute value.

### Wavelength Correction Function

The sensor element has a wavelength sensitivity distribution. If you set the wavelength of light to be measured, the wavelength correction function inside the sensor suppresses variations in measured values due to wavelength sensitivity.

The power display unit is changed to “dBm”, “dB”, “W(abs)”, or “W(rel)”.

“dBm” and “W” show the absolute value while “dB” and “W(rel)” show the relative value.

### Optical Power Display Function

The power display unit is changed to “dBm”, “dB”, “W(abs)”, or “W(rel)”.

“dBm” and “W(abs)” show the absolute value while “dB” and “W(rel)” show the relative value.

Additionally, the power display unit has the following relationship.

$$Pd_{\text{Binput}} = 10 \times \log (P_{\text{winput}}(W)/1 \times 10^{-3}(W))$$

where

$Pd_{\text{Binput}}$ : Optical input power (dBm)

$P_{\text{winput}}$ : Optical input power (W)

Furthermore, the display values have the following relationship.

$$Pd_{\text{Bdisplay}} (\text{dBm}) = Pd_{\text{Bm}} (\text{dBm}) + \text{CAL} (\text{dB})$$

$$P_{\text{wdisplay}} (W) = 10^{Pd_{\text{Bdisplay}} (\text{dBm})/10} \times 10^{-3}$$

$$Pd_{\text{B}} = Pd_{\text{Bdisplay}} (\text{dBm}) - Pd_{\text{Bref}} (\text{dBm})$$

$$P_{\text{w}} = P_{\text{wdisplay}} (W)/P_{\text{wref}}(W)$$

where

$Pd_{\text{Bm}}$ : Measurement value (dBm) when set at “dBm”.

$Pd_{\text{Bdisplay}}$ : Measurement display value (dBm) when set at “dBm”.

$P_{\text{wdisplay}}$ : Measurement display value (W) when set at “W(abs)”.

$Pd_{\text{B}}$ : Measurement display value (dB) when set at “dB”.

$P_{\text{w}}$ : Measurement display value (no unit) when set at “W(rel)”.

CAL: Power offset value (dB)

$Pd_{\text{Bref}}$ : Relative reference value (dBm)

$P_{\text{wref}}$ : Relative reference value (W)

### Note

- The power offset value is the offset value set in “Setting the Power Offset Value”. For details, see Setting a Power Offset Value (page 3-5).
- The relative reference value is the value shown in “Reference”. For details, see Setting the Reference Mode (page 3-6) and Setting a Reference Value (page 3-8).

## 1.3 Optical Sensor Function

---

### Average

Averages the measured results within a specified time and displays the average. Note that the averaging time may vary depending on the modulation setting.

#### Averaging Time by Modulation Setting

Averaging time	CW setting	CHOP setting
100 $\mu$ s	Yes	—
200 $\mu$ s	Yes	—
500 $\mu$ s	Yes	—
1 ms	Yes	—
2 ms	Yes	—
5 ms	Yes	—
10 ms	Yes	—
20 ms	Yes	—
50 ms	Yes	Yes
100 ms	Yes	Yes
200 ms	Yes	Yes
500 ms	Yes	Yes
1 s	Yes	Yes
2 s	Yes	Yes
5 s	Yes	Yes
10 s	Yes	Yes

#### Note

---

- For the AQ2200-221 sensor module, only for CW, the selectable range is 200  $\mu$ s to 10 s.
  - For the AQ2200-215/212/222 sensor modules, only for CW, the selectable range is 100  $\mu$ s to 10 s.
  - For the AQ2200-202 interface module, only for CW, the selectable range is 100  $\mu$ s to 10 s.
  - When switching from CW mode to CHOP mode, if the averaging time is invalid in chop mode (e.g. 100  $\mu$ s to 20 ms), the averaging time is automatically set to 50 ms.
  - When setting the averaging time to 100  $\mu$ s to 50 ms, if MaxMin mode is set to Window, the averaging time automatically sets to 100 ms(except for AQ2200-202/212/222).
- 

### Measurement Mode

Three kinds of measurement mode are provided. Select an optimal measurement mode corresponding to the measurement application.

- Normal: Measurement is always performed to update the measurement value at any time.
- Single: Measurement is performed once and the measurement value is updated after completion of the measurement.
- Input Trigger: Measurement is performed by the trigger input and the measurement value is updated after completion of the measurement.

#### Note

---

- For details about how to input the trigger, see section 9.1 in the IM735101-04EN.
  - The measurement restart is accepted even while the measurement is running in the Single mode or Input Trigger mode.
  - The measurement is performed only once in the Single mode or Input Trigger mode. After that, the measurement is not started until the Normal mode or Single mode is started or the trigger is input.
  - When "Input Trigger" is set for both the device 1 and device 2 in the AQ2200-221, the average time setting is changed to a time longer than the value, which has already been set for the device 1 or device 2. Additionally, if the averaging time is changed in this status, the time settings of both the device 1 and device 2 are also changed.
-

### Measurement of Maximum/Minimum Value

When measuring polarization dependent loss, etc., the maximum and minimum values are measured, and the difference between them is calculated. Measurement intervals can be selected with the following 4 modes (5 for the AQ2200-202/212/222) for updating the maximum and minimum values.

- Continuous: The maximum value, minimum value, and (maximum value - minimum value) are updated every time the measurement value is updated between the mode setting and mode OFF.

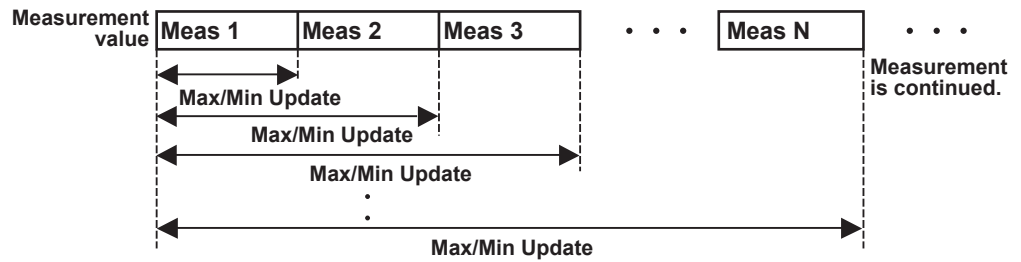

- Window: The maximum value, minimum value, and (maximum value - minimum value) are calculated from the measurement values of sample quantity specified in "Data Points". For data, the latest measurement value is taken to update the measurement value while disposing of the oldest measurement value.

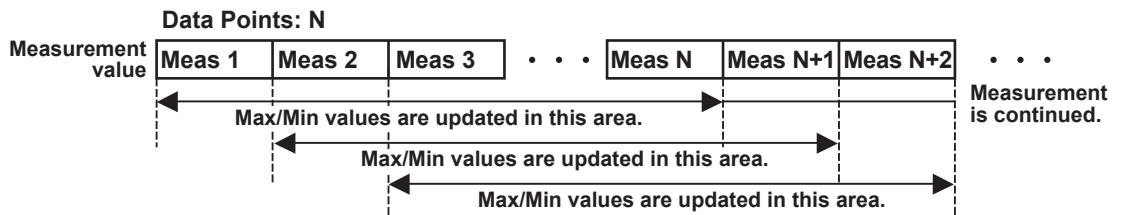

After measurement starts, if the number of samples specified by Data Points is not reached, the maximum value, the minimum value, and the difference between the two are displayed based on the measurement values up to that point.

- Refresh: This is the same as in Continuous mode, but after measuring the number of samples specified under "Data Points," measurement stops.

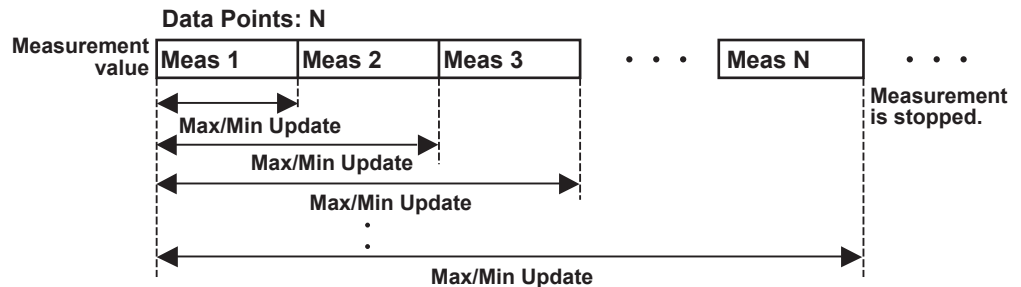

### 1.3 Optical Sensor Function

- Event Trigger: This can be set only for the AQ2200-202/212/222. Incidents of measured values crossing the Power Thresh value set with Event are considered events. Measurements are made according to the Event Position setting for the number of samples specified by Data Point, and then the measurement stops.
  - 0%: Measurements are made with the first data as the trigger point, and the maximum value and minimum value are calculated.
  - 50%: Measurements are made with the center of Data Point as the trigger point, and the maximum value and minimum value are calculated.
  - 100%: Measurements are made with the end of the data as the trigger point, and the maximum value and minimum value are calculated.

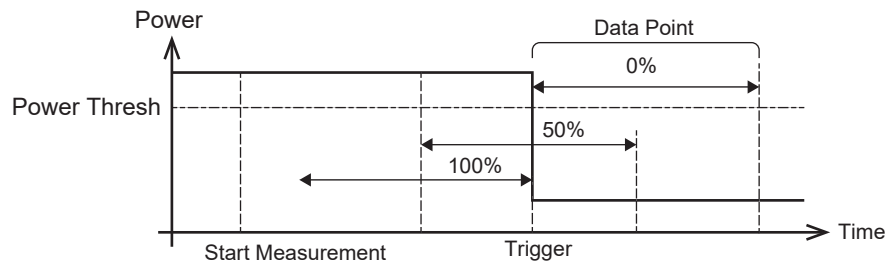

- Off: The modes set are turned OFF. Unless "OFF" is set, the above modes will not be cancelled.

### Setting the Number of Data Points

The number of measurement data points (1 to 20000) to be used in the Window mode and Refresh mode of the Max/Min measurement can be set for the data points.

#### Note

For AQ2200-221, the number of data points setting becomes 1 to 10000.

For AQ2200-202/212/222, the ratio of the number of acquired data points to the specified number of data points is shown with a dark blue indicator.

When measurement is made in Event Trigger mode, the position of the event trigger point is shown in yellow in the bar graph.

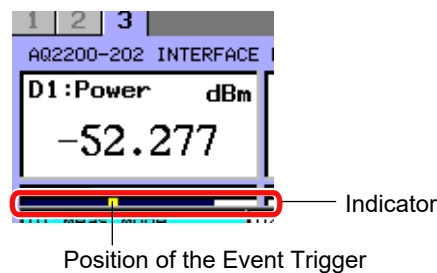

## Measurement Range

The measurement range can be set in steps of 10 dB. A measurement range can be selected from two modes described below.

- AUTO range: An optimal range is set automatically corresponding to the input optical power. Normally, this mode is used.
- HOLD range: A measurement range can be set manually.

### Note

The measurement range currently being measured in the AUTO range mode is shown in brackets next to the "AUTO" in the "Range" field on the screen.

When using the HOLD range, pay special attention so that the optical input power must be within the range during operation.

The optical input power status within the range can be checked through the range bar. The range bar shows the currently input power graphically. The left end shows the lower limit of the range while the right end shows the upper limit.

Additionally, if the measurement display value is shown in orange, this shows the measurement range-over. If it is shown in dark brown, this shows the measurement range-under. An optimal measurement range is selected so that the measurement value is shown in black, that is, normal color.

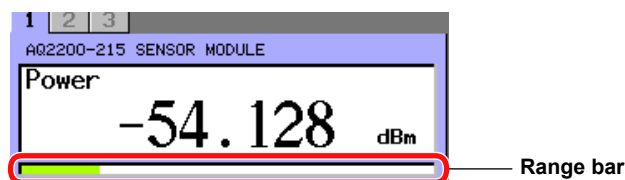

Range Bar on DETAIL Screen

## Set the modulation mode (CW/CHOP) Function

To accurately measure the optical power, you must set the modulation mode corresponding to that of the optical input.

For the modulation mode, the CW light or CHOP (50% DUTY) modulation light can be selected. Additionally, select an optimal CHOP modulation light from 270 Hz, 1 kHz, or 2 kHz.

### Note

- The AQ2200-215 sensor module does not support the CHOP light.
- The AQ2200-221 sensor module does not support the CHOP light.
- The AQ2200-212/222 sensor modules do not support the CHOP light.
- The AQ2200-202 interface module does not support the CHOP light.

## ZERO-SET Function

When performing the ZERO-SET, the electrical offset inside the sensor is adjusted, allowing you to accurately measure the absolute value.

Two kinds of ZERO-SET modes are provided as described below.

- Zero: Starts the ZERO-SET of the current module.
- Zero ALL: Perform a ZERO-SET of all installed sensor modules and AQ2200-331/332/342 ATTN modules.

### Analog Output Function

The analog output function outputs voltages from the analog output terminal on the front panel according to the analog output mode.

This enables analog output that corresponds to the input optical power in real time (Approx. 0 to 2 V. With the AQ2200-202/212, voltage output ranging from approx. 0 to 5 V is also possible.). The following three modes (four for the AQ2200-202/212) are available for analog output. Select the mode most suitable for your application.

- **AUTO mode:** For outputting voltages of approximately 0 to 2 V or approximately 0 to 5 V (AQ2200-202/212) for each individual measuring range.
- **LINEAR mode:** For setting the maximum level (power level setting for outputting the analog output maximum value: typical maximum range value + 3 dBm – typical minimum range value + 3 dBm (in steps of 0.1 dB)) and power range (power range for analog output: 3 to 24 dB (in 3 dB steps)), and outputting voltages of approximately 0 to 2 V or approximately 0 to 5 V (AQ2200-202/212) in proportion to optical power (W) falling within a specified range.
- **LOG mode:** For setting the maximum level (power level setting for outputting the analog output maximum value: typical maximum range value + 3 dBm – typical minimum range value + 3 dBm (in steps of 0.1 dB)) and power range (power range for analog output: 3 to 60 dB (in 1 dB steps)), and outputting voltages of approximately 0 to 2 V or approximately 0 to 5 V (AQ2200-202/212) in proportion to optical power (dB) falling within a specified range.

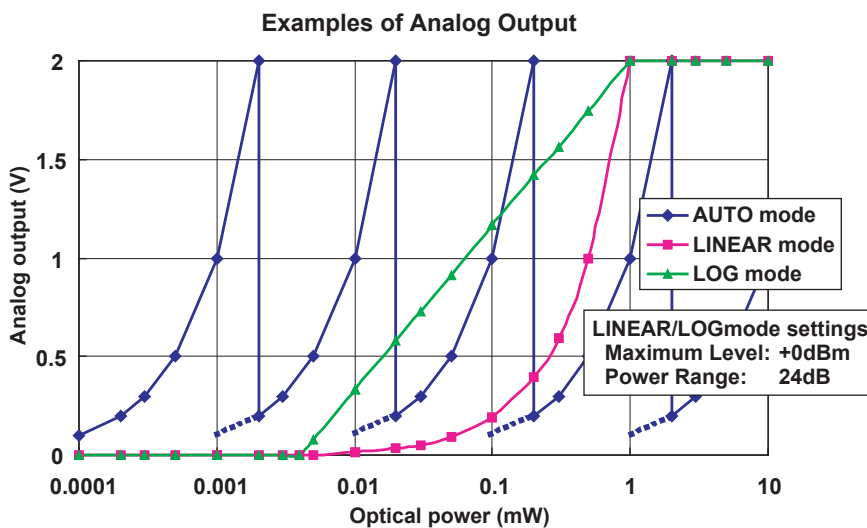

- **Trigger mode:** This can be set only for the AQ2200-202/212. Trigger signals are output from the analog output terminals. These are the same as the signals output from the Trigger Out connector on the rear of the frame controller. For details of the trigger signal, see section 8.2 in the AQ2200 Series Multi-Application Test System User’s Manual [Application Operation] (IM 735101-04EN).
  - Avg Time Over: Outputs a trigger signal when measurement is complete.
  - Meas Started: Outputs a trigger signal when a measurement is started.
  - Event Detect: Outputs a trigger signal when an event occurs.



### Analog Output Signal

This connector can output a voltage according to the level of the optical signal input to the sensor. Modify the plug (supplied with the sensor) as shown below, and insert it into "ANALOG OUT" on the sensor's panel to output the voltage.

Ensure that the length of the wiring is 2 m or less.

**Connector:** Mini plug  
**Output impedance:**  
Approx. 1 k $\Omega$   
**Maximum output voltage:**  
Approx. 2 V

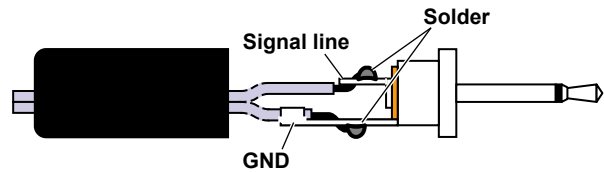

The AQ2200-202/212's analog output terminals are BNC.

### Holding the Sensor Measurement Value Display

You can stop the measurement data display update. With this function, you can check this measurement data record.

## 1.4 Variable Attenuator Function

### Sets the Optical Attenuation

In the ATTN Module, you can attenuate the optical power by specifying an attenuation. On the AQ2200-342, the optical output power can be held constant by automatically adjusting the attenuation amount according to the changes in the input optical power. The following shows the relationship between the attenuation and attenuation offset value.

$$\text{ATT (dB)} = \text{ATTdisplay (dB)} - \text{ATToffset (dB)}$$

where

ATT: Attenuation (dB) SMF : 0 to 60 dB, 0.001dB step  
0 to 40 dB, 0.001dB step (AQ2200-342)  
MMF : 0 to 45 dB, 0.001dB step

ATTdisplay: Attenuation display value (dBm)

ATToffset: Attenuation offset value (dB) (See "Changing the Attenuation Offset Value" (page 7-5).

### Sets the Wavelength

In the ATTN Module, you can set a more accurate attenuation by specifying a wavelength.

- **AQ2200-311**

Minimum settable wavelength: 1200.0 nm  
Maximum settable wavelength: 1700.0 nm

- **AQ2200-311A/312**

For ATTN module applicable to SMF

Minimum settable wavelength: 1200.0 nm  
Maximum settable wavelength: 1700.0 nm

For ATTN module applicable to MMF

Minimum settable wavelength: 800.0 nm  
Maximum settable wavelength: 1370.0 nm

- **AQ2200-331/332**

For ATTN module applicable to SMF

Minimum settable wavelength: 1200.0 nm  
Maximum settable wavelength: 1700.0 nm

For ATTN module applicable to MMF

Minimum settable wavelength: 800.0 nm  
Maximum settable wavelength: 1370.0 nm

- **AQ2200-342**

Minimum settable wavelength: 1260 nm  
Maximum settable wavelength: 1640 nm

### Optical Output Set Function (AQ2200-331/332/342)

The optical attenuation is adjusted automatically so that the set optical output value is obtained. This optical output value includes the power offset value.

$$P \text{ (dBm)} = \text{PSET (dBm)} - \text{Poffset (dB)}$$

where

P: Laser output power (dBm)

PSET: Output set value (dBm)

Poffset: Power offset value (dB)

## 1.5 Optical Switch Function

This OSW module is used to change the connection route among multiple DUTs, which are connected to this module.

Two kinds of modules are provided, one is the single type module constructing the configuration with one OSW (Optical Switch) and the other is the dual type module constructing the configuration with two OSWs.

The following describes these module types.

### AQ2200-411 OSW Module: Configuration with single OSW

Two kinds of OSWs are provided, "1 x 4" and "1 x 8". Modules for SM and GI with applicable optical fibers are provided for each OSW type.

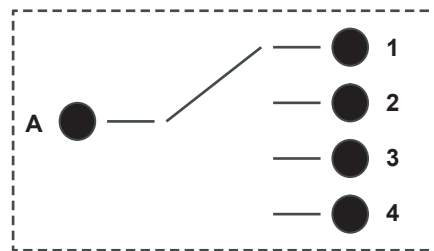

"1 x 4" OSWs (For SM and GI)

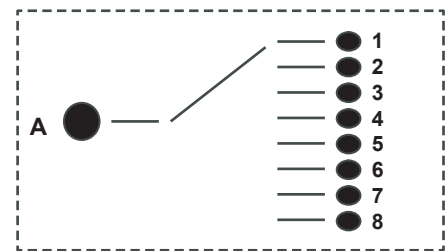

"1 x 8" OSWs (For SM and GI)

### AQ2200-412 OSW Module: Configuration with single OSW

OSW is provided "1 x 16". This module is applicable for SM and GI.

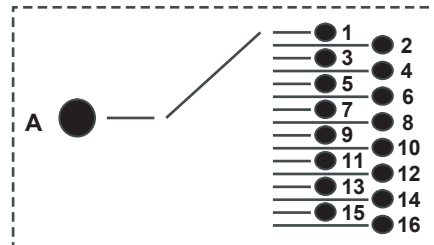

### AQ2200-421 OSW Module: Configuration with dual OSWs

Two kinds of OSWs are provided, two "1 x 2" and two "2 x 2". Modules for SM and GI with applicable optical fibers are provided for each OSW type.

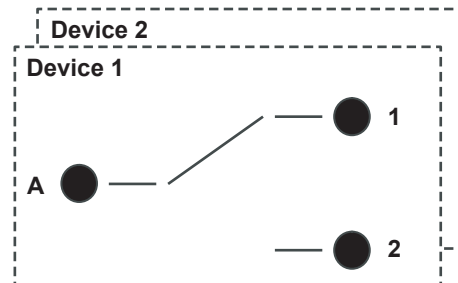

"1 x 2" Dual OSWs (For SM and GI)

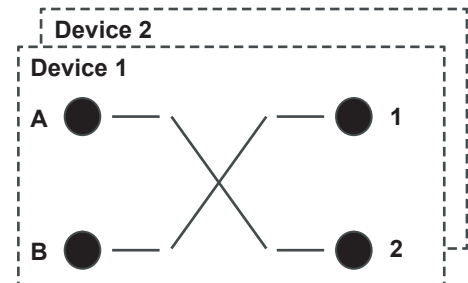

"2 x 2" Dual OSWs (For SM and GI)

## 1.6 BERT Function

### BERT Overview

This module is a 10 Gbit/s-band BERT (bit error rate measurement) module to be mounted on the AQ2200-series Frame Controller.

This module is a functional block that consists of a SG part generating the clock signal, a PPG part generating the pattern, and an ED part measuring the error.

### Major Features

- This module is a 10 Gbit/s-BERT module<sup>1</sup> to be mounted on the AQ2200-series Frame Controller<sup>2</sup>.
- SG (Signal Generator), PPG (Pulse Pattern Generator), and ED (Error Detector) are provided. The 10 Gbit/s-band error bit test can be performed only with one unit.
- The module is applicable to the 10 Gbit/s-band bitrate.  
Bitrate: 9.95 Gbit/s to 11.32 Gbit/s
- For the PPG output, the amplitude, offset, and cross point can be changed variably.  
Data output amplitude: 0.5 V<sub>pp</sub> to 2.0 V<sub>pp</sub>  
Data offset: -2.0 V to +3.0 V  
Data cross point: 30% to 70%
- CDR is built-into the ED. The bit error test can be performed without wiring of the clock signal.
- The receive threshold level of the data input signal of the ED can be changed variably.
- As for the output of the trigger signal of this module, the following usages can be done.
  - As a trigger signal for measurement of waveforms
  - As a frequency dividing clock for optical transceiver
  - As a reference clock when synchronizing multiple module
- The BERT module is simply made applicable to the optical interface by combining the light source module<sup>3</sup>, optical modulation module<sup>4</sup>, optical receiving module<sup>5</sup>, and/or attenuator module<sup>6</sup> of the AQ2200-series.
- By combining various modules of the AQ2200-series, a test system is constructed easily, in which the BERT is integrated with other applications.

1 AQ2200-601 10 Gbit/s BERT Module

2 AQ2201 Frame Controller (3-slot type)  
AQ2202 Frame Controller (9-slot type)

3 AQ2200-111 DFB-LD Module

4 AQ2200-621 10 Gbit/s Optical Modulator (1550 nm)  
AQ2200-622 10 Gbit/s Optical Modulator (1310 nm)

5 AQ2200-631 10 Gbit/s Optical Receiver

6 AQ2200-311 ATTN Module  
AQ2200-311A ATTN Module  
AQ2200-331 ATTN Module

## BERT Block Diagram

The following shows the block diagram of this module.

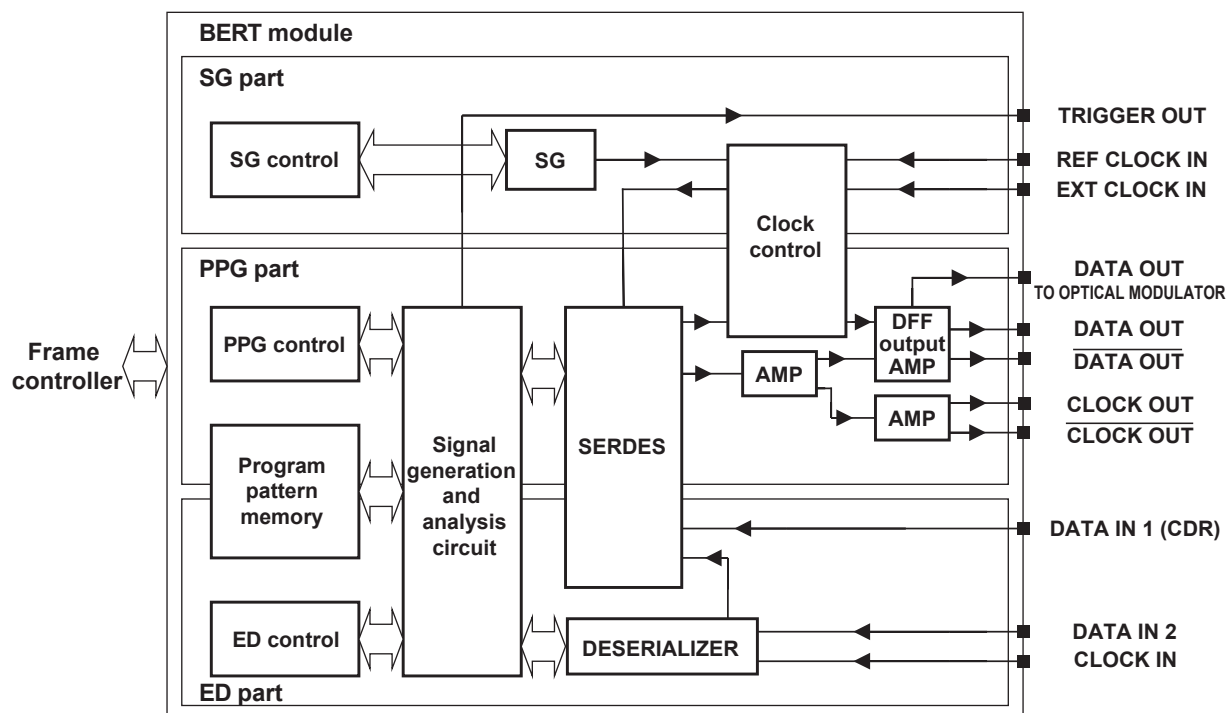

### SG part: Signal Generator

In this circuit block, a highly accurate clock is generated based on the internal quartz oscillator. According to the bitrate setting, the frequency can be changed.

### PPG part: Pulse Pattern Generator

In this circuit block, the PRBS pattern\* and program pattern are generated. Additionally, in the AMP of the CLOCK OUT, the offset can be changed. In the AMP of the DATA OUT, the amplitude, offset, and cross point can be changed.

### ED part: Error Detector

In this circuit block, the bit error is detected from the PRBS pattern\* and program pattern, and then it is counted. (The bit error count results are informed to the frame controller at real-time.)

\*: PRBS pattern  
Pseudo Random Bit Sequence pattern (Pseudo random pattern)

### Data Logic Inverting Function

This module provides a data logic inverting function that inverts the logic of the data output signal of the PPG and the data input signal of the ED.

Logic Positive: Positive logic  
Negative: Negative logic

#### **Note**

---

The Positive/Negative logic is inverted at the data invert output terminal.

---

### Data Logic

The following shows the data logic handled by this module.

- **DATA OUT terminal**

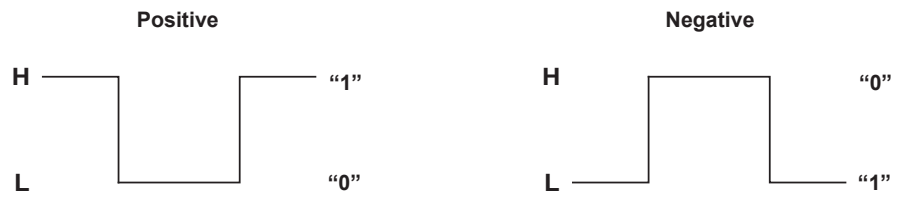

- **$\overline{\text{DATA OUT}}$  terminal**



## Output Variable Change Function

With this module, the outputs of the Data amplitude, Data offset, Data cross point, Bitrate, Bitrate offset, and Clock offset can be changed.

With this output variable change function, the test can be performed corresponding to the interface conditions for the DUT. Additionally, the performance evaluation test of the DUT can be performed by changing the output level.

### Data Amplitude

The amplitude of the data (DATA OUT/ $\overline{\text{DATA}}$  OUT terminal) can be changed.

Data amplitude: 0.50 to 2.00 [Vpp]      0.01 [Vpp] step

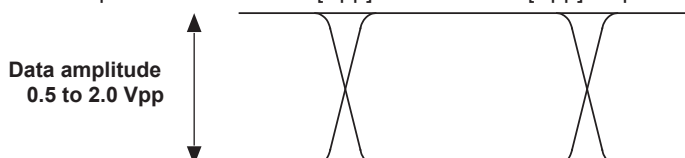

Note that the output of the DATA OUT TO OPTICAL MODULATOR terminal cannot be changed.

### Data Offset/Clock Offset

The DC offset voltage of the data (DATA OUT/ $\overline{\text{DATA}}$  OUT terminal)/clock (CLOCK OUT/ $\overline{\text{CLOCK}}$  OUT terminal) can be changed.

For the DC offset voltage, the average value of the output level becomes the reference level.

Data offset/Clock offset: -2.00 to 3.00 [V]      0.01 [V] step

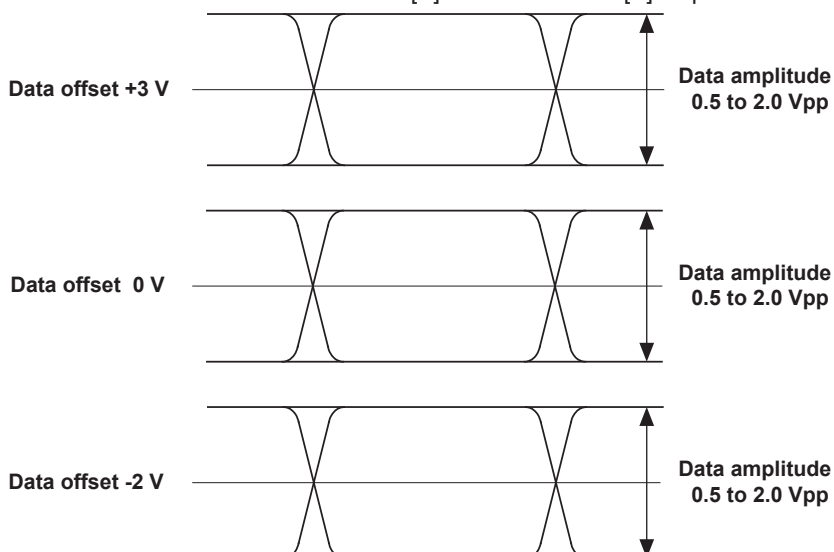

For the Clock offset, the DC offset voltage can be changed in the same manner as described above. However, the amplitude is fixed at approximately 0.60 [Vpp].

### Data Cross Point

The cross point of the H/L level of the data can be changed.

Data cross point: 30 to 70 [%]    1 [%] step

- **DATA OUT terminal**

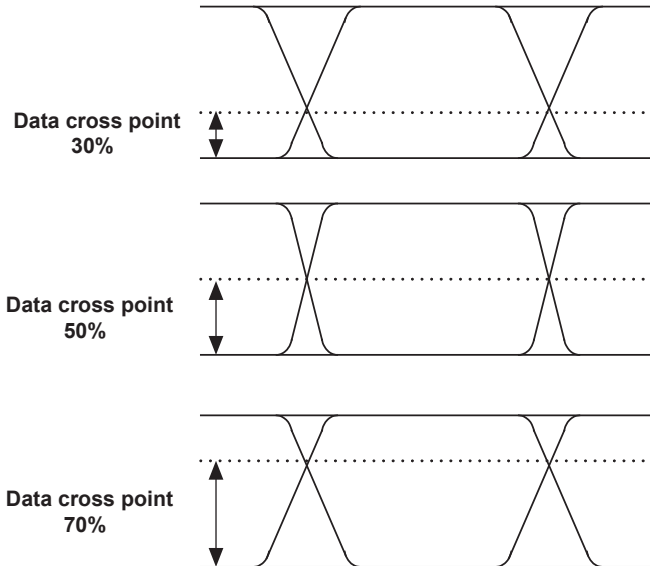

- **$\overline{\text{DATA OUT}}$  terminal**

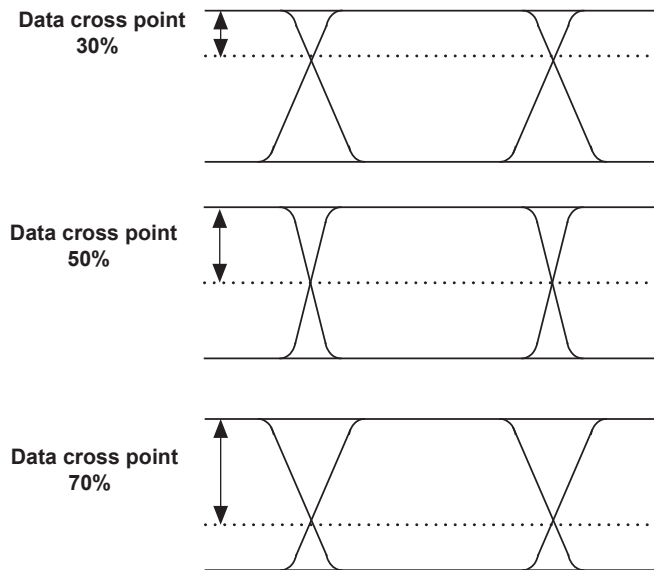

When using  $\overline{\text{DATA OUT}}$ , the signal of the cross point, that the setting ranging from 100% to set value is subtracted, is output.

The cross point shows the value at the end of the recommended coaxial cable Sucoflex104 (L = 0.7 m).



**Bitrate**

The bitrate of the internal SG can be changed.

Bitrate: 9.95 to 11.32 [Gbit/s]      0.000001 [Gbit/s] step

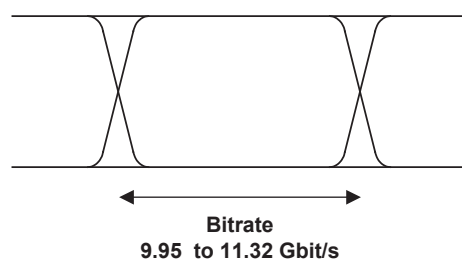
**Bitrate Offset**

The offset (frequency displacement amount) from the set bitrate can be changed.

Bitrate offset: -100 to +100 [ppm]    1 [ppm] step

**Threshold Level Variable Change Function**

This module allows you to adjust the threshold of DATA IN 1 or DATA IN 2 to an optimal level.

As you adjust the threshold while measuring the bit error, you can find the points both in the positive and negative directions at which an error occurs. The threshold can be set to an optimal level by setting the threshold value at the center of the range where no error occurs.

- **Adjusting operation when the receiving signal level is low**  
When the receiving signal level is low, an error may occur. Even though the receiving signal level is low, you may remove the error by adjusting the threshold level.
- **Adjusting operation when the upper and lower waveforms are not symmetrical.**  
When the mark ratio is not 50%, the center of the amplitude may not be an optimal threshold. Even though the upper and lower waveforms are not symmetrical, you may remove the error by adjusting the threshold level.

### CDR Function

#### CDR: Clock & Data Recovery

This CDR function recovers the clock from the receive data signal and adjusts the re-timing of the data.

Since this module incorporates the CDR function, the module can perform the BER measurement without connection of the clock.

#### Example of Connection with DUT

The following shows an example of connection between this module and DUT using the CDR function.

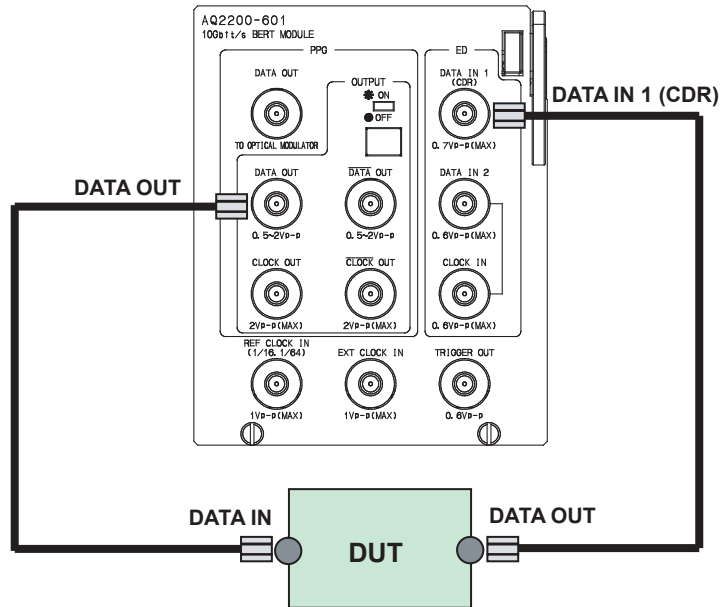

## Trigger Output Function

### Types of Triggers

This module provides a trigger output function.

One trigger can be selected from those listed below.

#### **Clock trigger: TX1/16, TX1/64, RX1/16, or RX1/64**

Clock signal is output, which is 1/16 or 1/64 of the send clock rate of the PPG (TX1/16, TX1/64) or the receive clock rate of the ED (RX1/16, RX1/64).

#### **Pattern trigger: TXPatt or RXPatt**

Trigger signal is output, which is synchronized with the send pattern (TXPatt) of the PPG or the receive pattern (RXPatt) of the ED.

- PRBS pattern:  
Positive pulse signal for 128 bits is output at intervals of cycles 128 times larger than the PRBS pattern.
- Program pattern (16 to 256 bits):  
Positive pulse signal for 128 bits is output at intervals of cycles 128 times larger than the program pattern length.
- Program pattern (256 to 67108864 bits):  
Positive pulse signal for 128 bits is output at intervals of program pattern length.
- SDH/SONET frame pattern:  
Positive pulse signal for 128 bits is output at intervals of STM-64/STS-192 frame pattern length (155520 bytes).

#### **Error trigger: TXERR or RXERR**

When an error is added from the PPG to the data to be transmitted (TXERR) or when an error is detected in the received data in the ED (RXERR), a positive pulse signal for 128 bits is output.

When even 1-bit error is added to or detected in the data, the positive pulse signal for 128 bits is output.

If an error is added or detected again while a 128-bit positive pulse signal is being output, the trigger pulse is not output newly.

When an error is added or detected at intervals of 128 bits, the pulse width of the trigger pulse signal is extended.

**Applications of Trigger**

**Trigger is used as the trigger signal for observation of waveform.**

The trigger can be used as the trigger signal when observing the 10 Gbit/s-waveform with a super-high frequency sampling oscilloscope.  
(Clock trigger, pattern trigger, error trigger)

**Trigger is used as the frequency dividing clock signal for measurement of the optical transceiver.**

For optical transceiver or other device, when the frequency, which is 1/16 or 1/64 of 10 Gbit/s, is input as reference clock, the 10 Gbit/s-clock signal is generated.  
When measuring the optical transceiver, such frequency dividing clock signal may be required.  
(Clock trigger)

**Trigger is used as the reference clock to synchronize multiple module units.**

The trigger is used as clock signal for synchronization when using multiple module units with they synchronized.  
(Clock trigger)

**Trigger Waveforms**

**Clock Trigger**

The following shows the relationship among clock trigger signal waveforms.

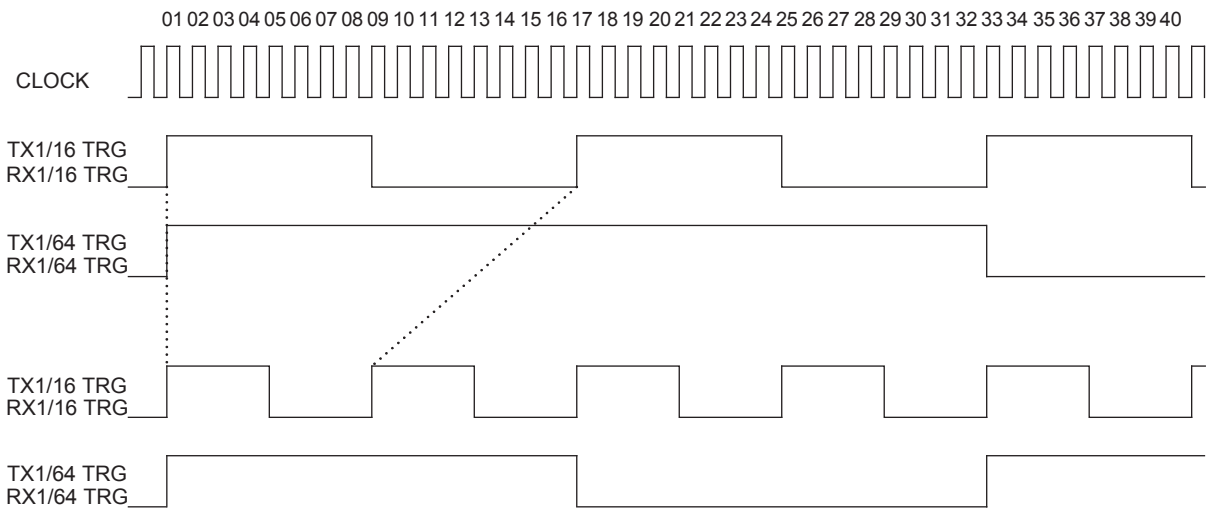

### Pattern Trigger

- **PRBS Pattern**

The following shows the relationship among trigger signal waveforms of the PRBS pattern.

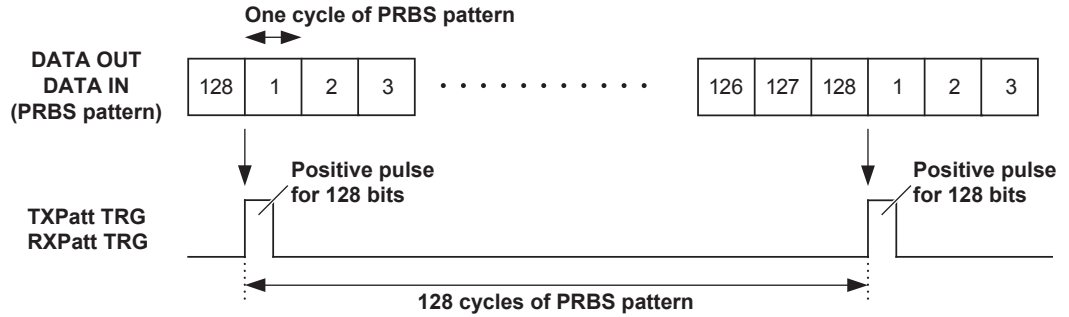

- **Program Pattern (16 to 256 bits)**

The following shows the relationship among trigger signal waveforms of the Program pattern (16 to 256 bits).

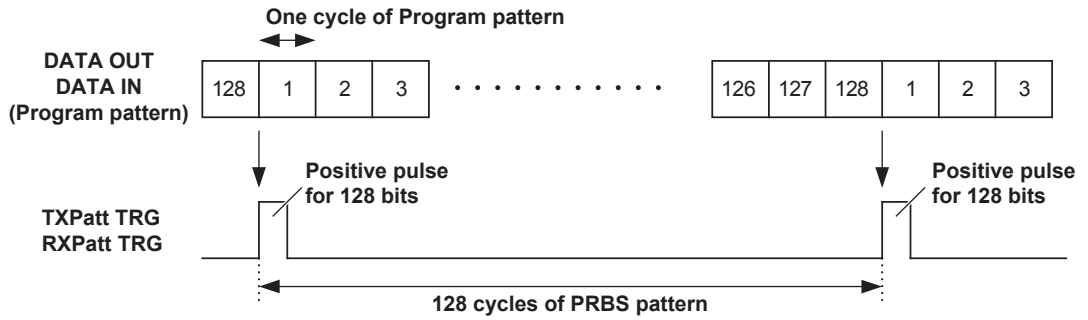

- **Program Pattern (256 to 67108864 bits)**

The following shows the relationship among trigger signal waveforms of the Program pattern (256 to 67108864 bits).

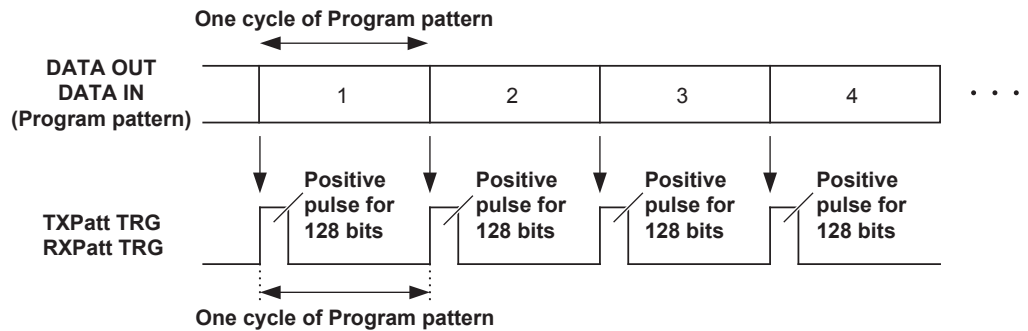

- **SDH/SONET Frame Pattern (155520 bytes)**

The timing relationship between the trigger waveform and SDH/SONET frame pattern is as follows:

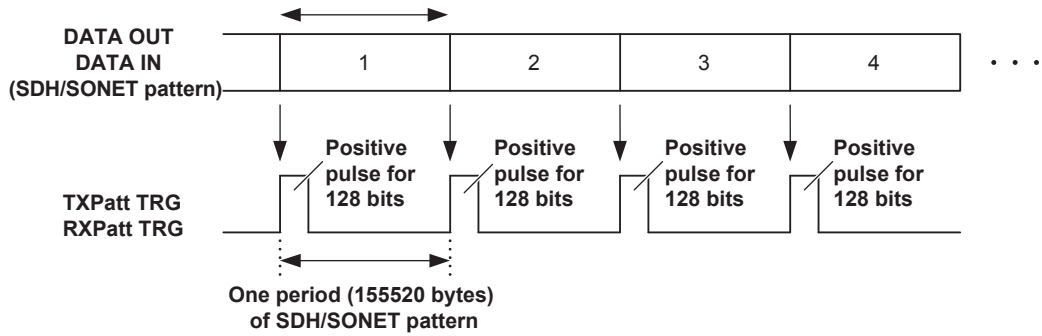

**Error Trigger**

The following shows the relationship among error trigger signal waveforms.

- **Error occurs at intervals of 128 bits or more.**

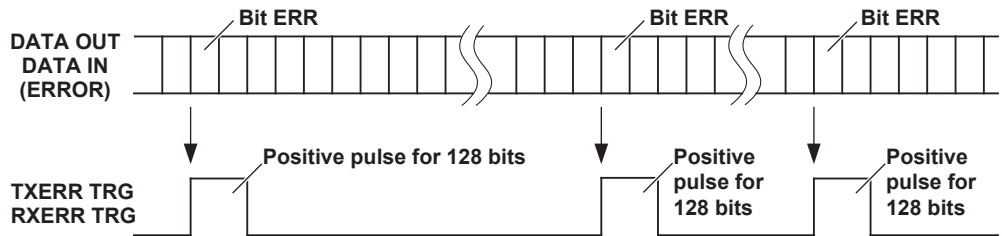

- **1-bit error occurs several times within 128 bits.**

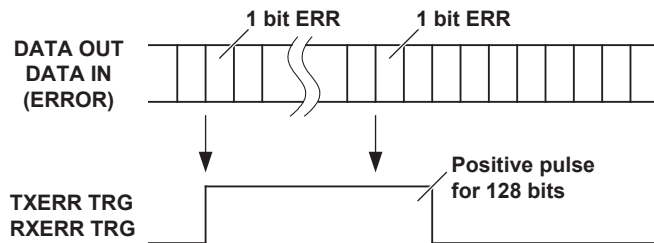

- **1-bit error occurs at intervals of 128 bits.**

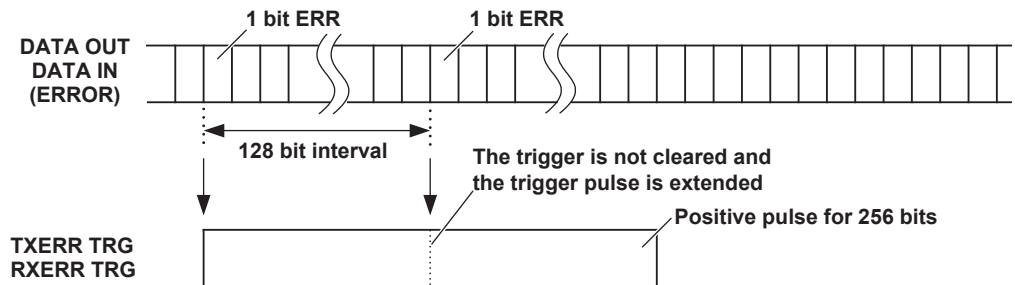

The timing of the 128-bit interval is arbitrarily determined inside the unit.

Connection Examples

Error trigger is used as trigger signal for observation of waveform.

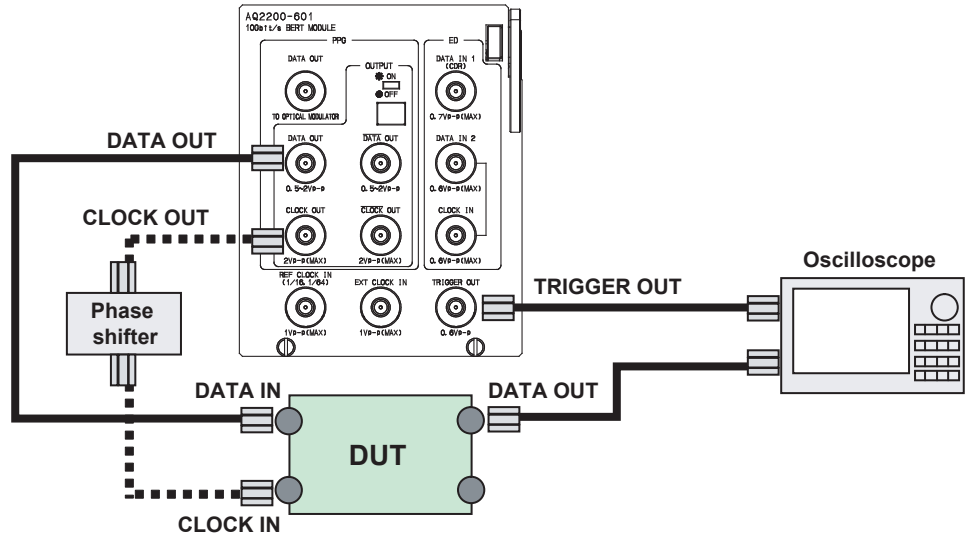

Error trigger is used as reference clock of optical transceiver.

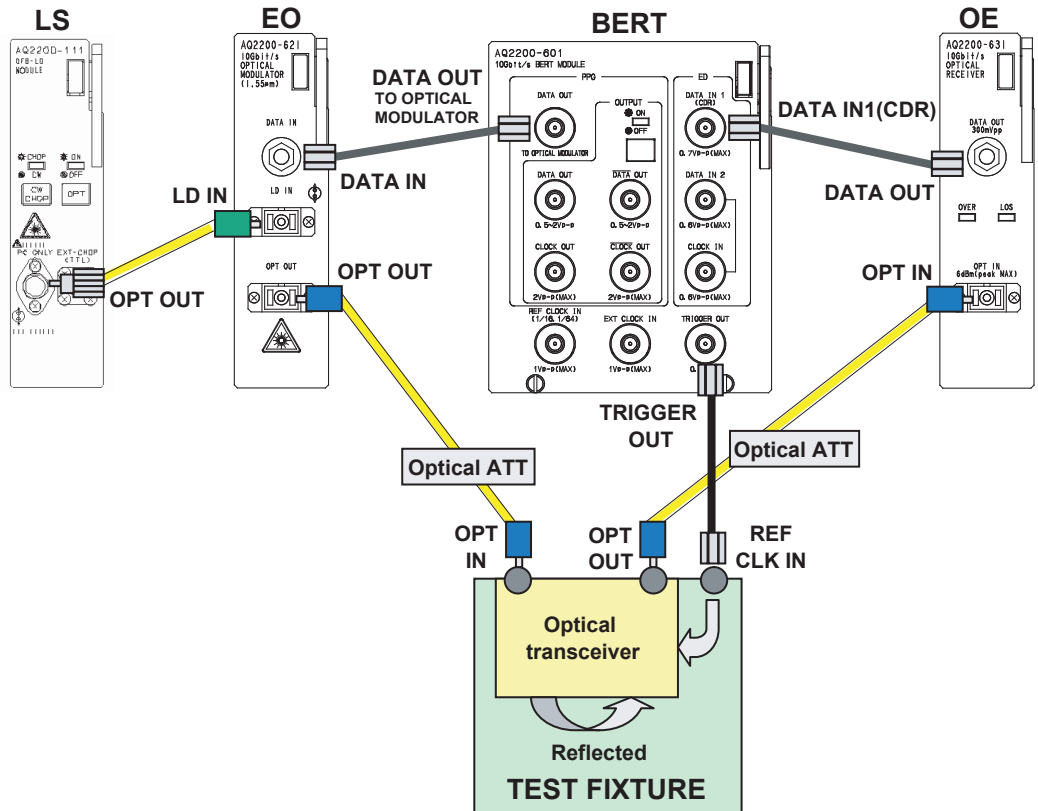

## 1.6 BERT Function

Error trigger is used as reference clock to synchronize multiple module units.

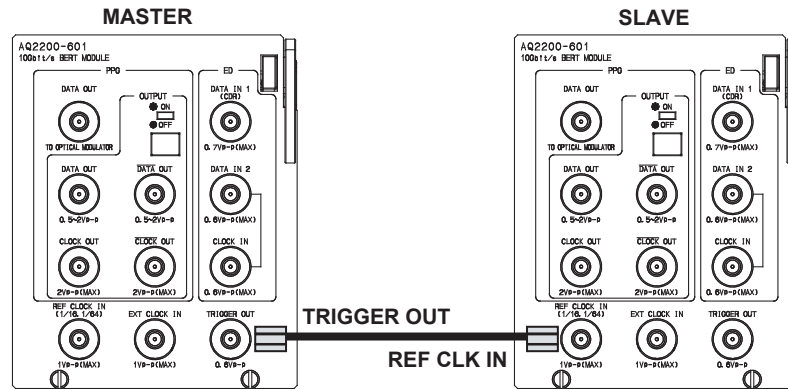



### Pseudo Random Pattern (PRBS Pattern) Generation

The following Table shows the principle of the pseudo random pattern generation. The pseudo random pattern is expressed by N-th generating polynomial expression shown in the Table below.

The cycle becomes “2N-1”. In the PRBS pattern having a cycle of “2N-1”, the pattern, in which “1” is continued N bits, is generated only once during one cycle.

For the output level of the PRBS pattern, “1” and “0” are applicable to the Low level and High level, respectively when the LOGIC is set at “Positive”.

The mark ratio of the PRBS pattern of this module is fixed at “1/2”.

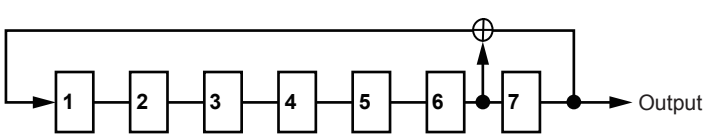
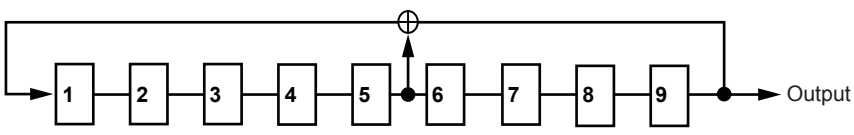
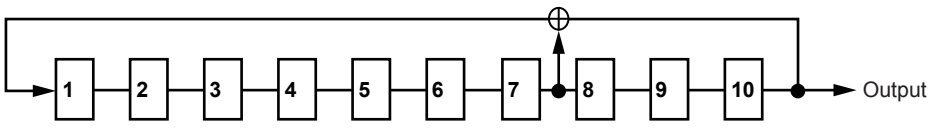
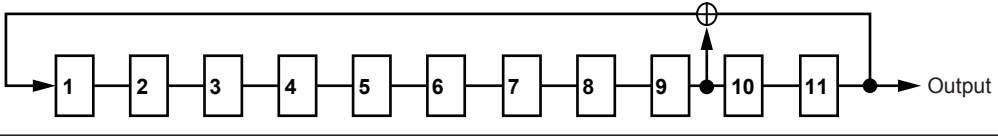
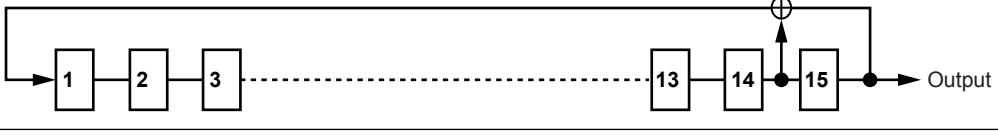
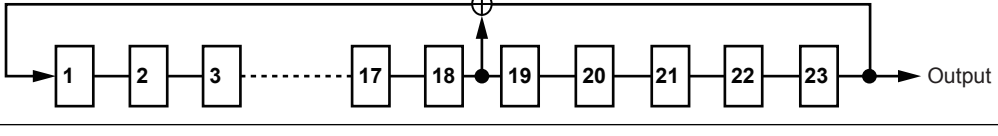
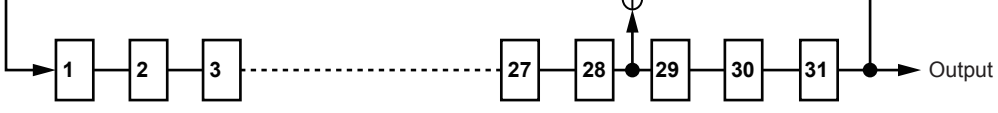
Cycle	Generating Polynomial Expression	Pattern Generation Block
$2^7 - 1$	$1 + X^6 + X^7$	
$2^9 - 1$	$1 + X^5 + X^9$	
$2^{10} - 1$	$1 + X^7 + X^{10}$	
$2^{11} - 1$	$1 + X^9 + X^{11}$	
$2^{15} - 1$	$1 + X^{14} + X^{15}$	
$2^{23} - 1$	$1 + X^{18} + X^{23}$	
$2^{31} - 1$	$1 + X^{28} + X^{31}$	



## Auto Sync Function

In this module, the pattern is synchronized by the PRBS pattern or program pattern. This module provides an auto sync function that compares the input pattern with the reference pattern to automatically establish the pattern synchronization.

- **Normal measurement**

For normal measurement, the auto sync function is turned ON and the input pattern is compared with the reference pattern to automatically perform the synchronization. In the auto sync function ON status, the input pattern is always compared with the reference pattern.

Therefore, the auto sync function ON status applies to the normal measurement, in which only few errors occur and the sync loss does not occur.

**Note**

---

To turn ON the auto sync function, select ON with "Auto sync" on the ED page of the BERT application, and then press the OK soft key or ENTER.

---

- **Measurement with many errors**

If many errors occur and the sync loss occurs, the error is not counted by the sync loss and the correct error measurement cannot be performed in the auto sync function ON status.

In this case, the auto sync function is turned ON to establish the synchronization once. In this status, when turning OFF the auto sync function, the error measurement can be performed even though many errors occur and the sync loss occurs.

When the auto sync function is turned OFF before the synchronization has been established, the input pattern is separated and the synchronization established pattern is compared with the reference pattern to lock the pattern synchronization circuit. When the correct pattern is locked, the sync loss is hard to occur.

**Note**

---

- To turn OFF the auto sync function, select OFF with "Auto sync" on the ED page of the BERT application, and then press the OK soft key or ENTER.
  - When the auto sync function is turned OFF after establishment of the synchronization, the synchronization cannot be established.
- 

- **Synchronization establishment conditions/Sync loss conditions**

Whether or not the synchronization is established is judged based on the threshold value conditions for the pattern synchronization.

If the error rate exceeds the threshold value of the sync loss conditions, it is judged as sync loss status.

Additionally, if the error rate becomes the threshold value or less of the synchronization establishment conditions, it is judged as synchronization establishment status.

Furthermore, when the error rate always exceeds the threshold value of the sync loss conditions, the pattern cannot be synchronized.

The following page describes the pattern synchronization threshold value conditions for this module.

## Pattern Synchronization Threshold Value Conditions

Pattern Length		Sync Loss Conditions			Synchronization Establishment Conditions		
		Measure Bit	Error Bit	Rate	Measure Bit	Error Bit	Rate
PRBS	$2^{n-1}$ (n=7, 9, 10, 11, 15, 23, 31)	8192	1024	1.25E-01	128	2	1.56E-02
PROGRAM pattern	to 256 bits (*1)	16384	128	7.81E-03	16384	32	1.95E-03
	to 2048 bits (*2)	16384	8	4.88E-04	16384	2	1.22E-04
	to 8192 bits (*2)	65536	8	1.22E-04	65536	2	3.05E-05
	to 32768 bits (*2)	262144	8	3.05E-05	262144	2	7.63E-06
	to 131072 bits (*2)	1048576	8	7.63E-06	1048576	2	1.91E-06
	to 524288 bits (*2)	4194304	8	1.91E-06	4194304	2	4.77E-07
	to 1048576 bits (*2)	8388608	8	9.54E-07	8388608	2	2.38E-07
	to 2097152 bits (*2)	16777216	8	4.77E-07	16777216	2	1.19E-07
	to 4194304 bits (*2)	33554432	8	2.38E-07	33554432	2	5.96E-08
	to 8388608 bits (*2)	67108864	8	1.19E-07	67108864	2	2.98E-08
	to 16777216 bits (*2)	134217728	8	5.96E-08	134217728	2	1.49E-08
	to 33554432 bits (*2)	268435456	8	2.98E-08	268435456	2	7.45E-09
to 67108864 bits (*2)	536870912	8	1.49E-08	536870912	2	3.73E-09	

(\*1) Synchronization method: Bit Shift method

(\*2) Synchronization method: Read-in method

### PRBS Pattern Synchronization Method

The following shows the block diagram of the PRBS pattern synchronization method.

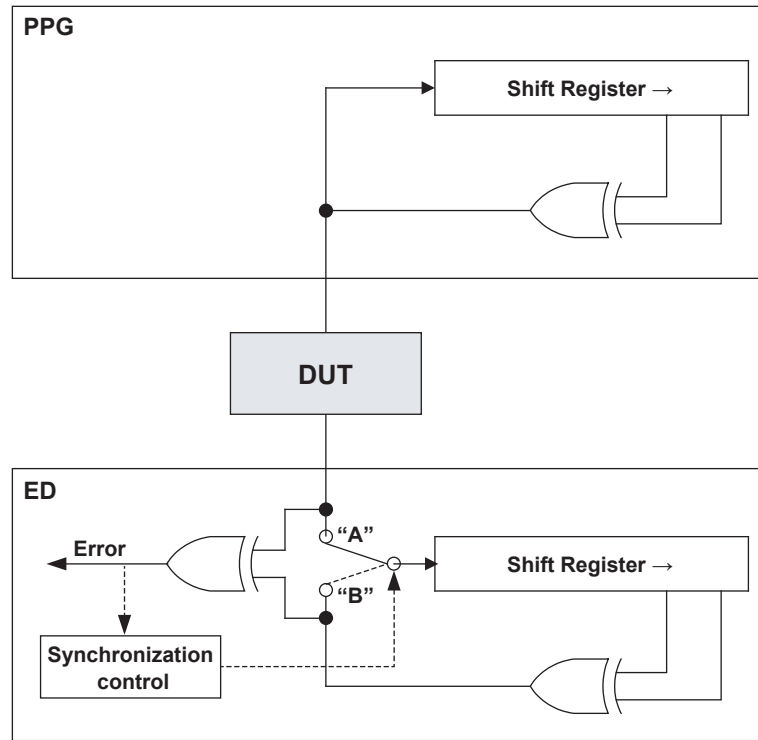

When "Auto Sync" is OFF, the switch is fixed at "B".

When "Auto Sync" is ON, this switch is automatically switched between "A" and "B".

### Program Pattern Synchronization

This module provides two kinds of Program pattern synchronization methods as described below.

1. Bit Shift method (16 to 256 bits)
2. Read-in method (256 to 67108864 bits)

#### Bit Shift Method

This synchronization method is applicable to a short program pattern with a pattern length of 16 bits to 256 bits.

The following shows the block diagram of the Bit Shift synchronization method.

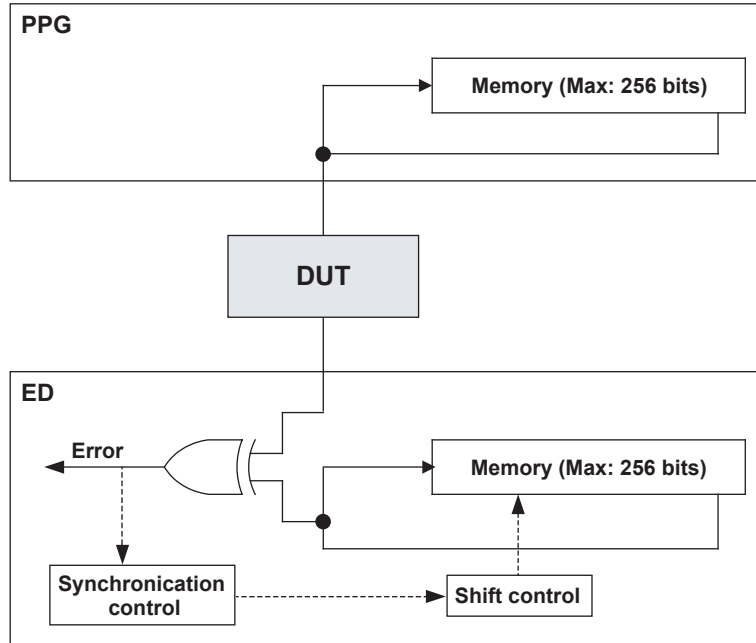

The reference pattern is compared with the receive pattern. If these patterns are not matched, the pattern is shifted one bit and it is compared with the reference pattern. This bit shift is performed repeatedly until the receive pattern meets the reference pattern in order to establish the synchronization.

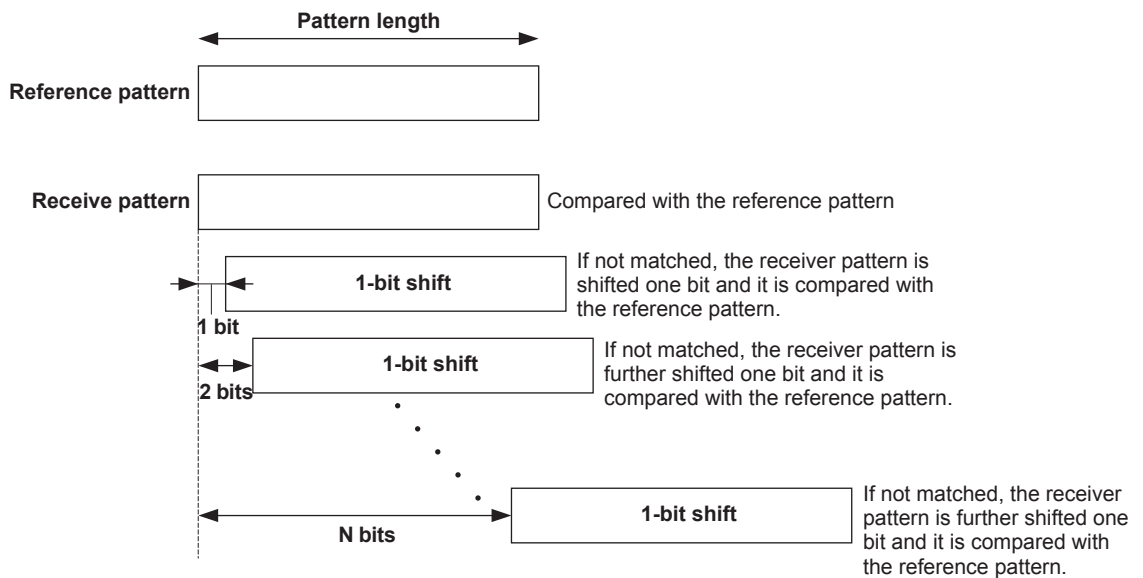

**Read-in Method**

This synchronization method applies to the program pattern with a length of 256 bits to 67108864 bits.

The following shows the block diagram of the read-in method.

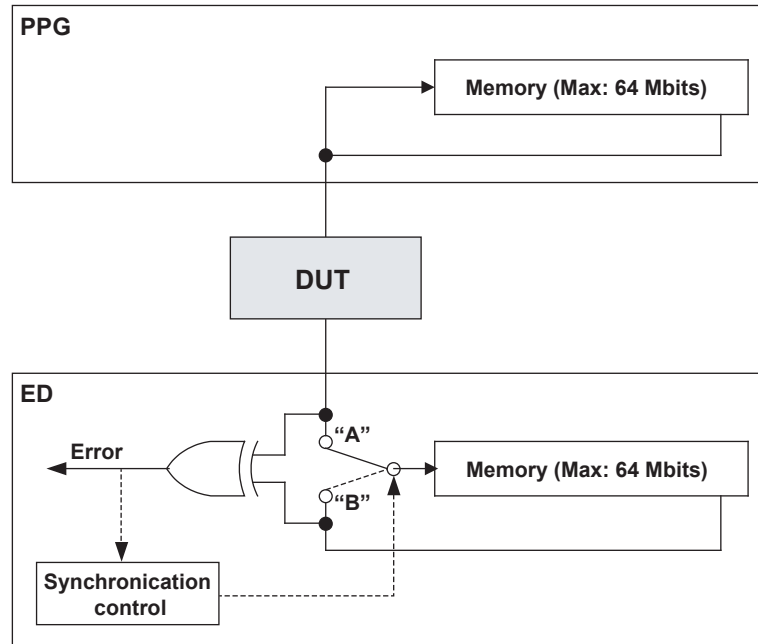

This synchronization method does not have any reference pattern. A pattern to be used as reference is made from the receive pattern and it is compared with the next receive pattern.

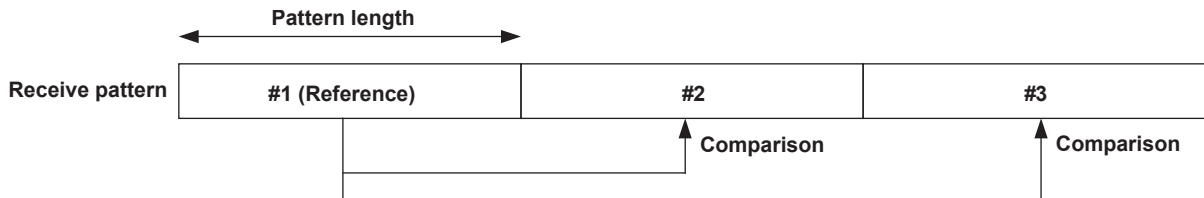

## SDH/SONET Frame

The SDH/SONET frame structure is shown in the following figure:

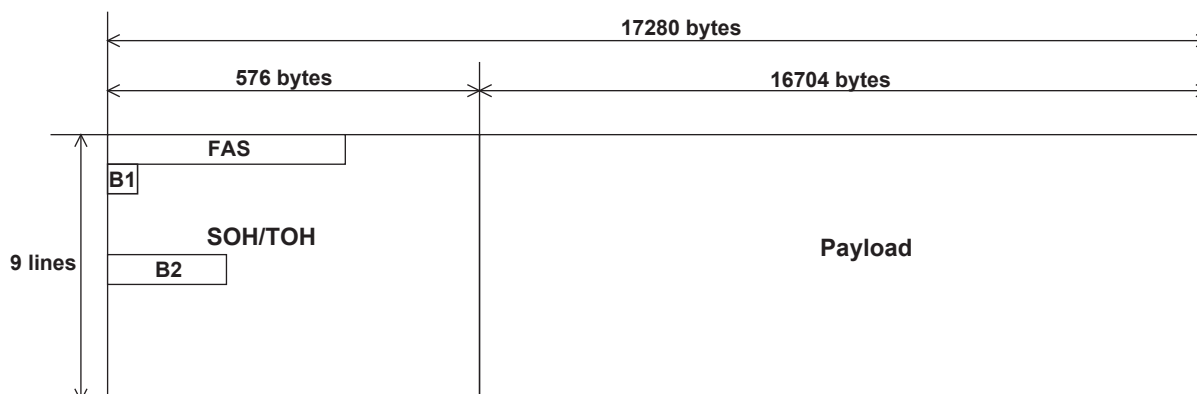

### SOH/TOH:

Values stored in the main unit (can be rewritten using a USB memory card and all bytes can be set to desired values).

### Payload:

All payload patterns are random (selected from PRBS9, PRBS10, PRBS11, PRBS15, PRBS23 and PRBS31).

### Scramble:

Always set to ON (all bytes except for the first line of the OH section are scrambled in accordance with ITU-T G.707).

### B1, B2:

Fixed values defined by SOH/TOH (provided with no computational parity bits)

## SDH/SONET Frame Synchronization Method

### Threshold Conditions for SDH/SONET Frame Synchronization

Desynchronization			Synchronization established			
Measure Bit	Error Bit	Rate	Frame synchronization	Payload pattern synchronization		
8192	1024	1.25E-01	Frame synchronization patterns are encountered two frames in a row	Measure Bit	Error Bit	Rate
				128	2	1.56E-02

### Flowchart of SDH/SONET Frame Synchronization/Desynchronization

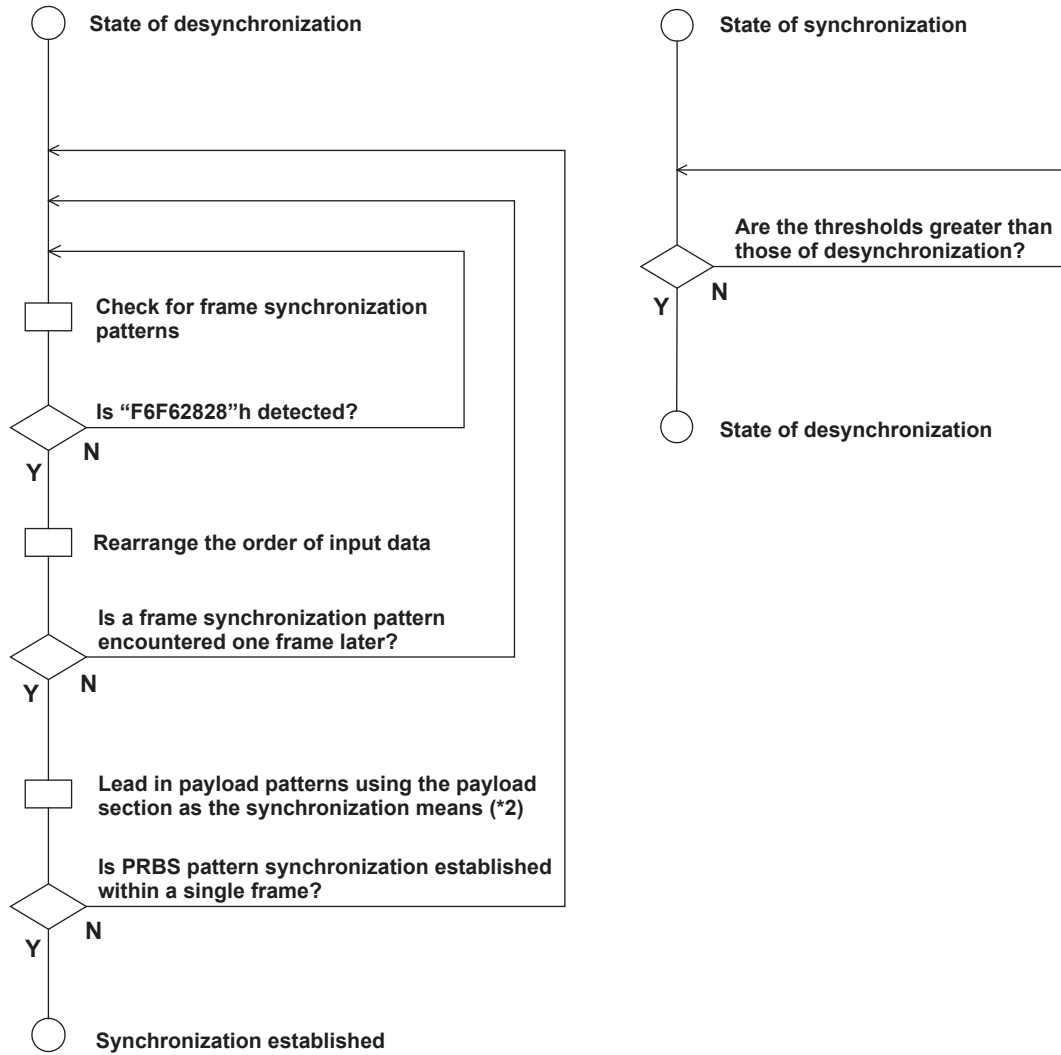



**(\*1) Frame Synchronization Pattern**

The four bytes, i.e., the sum of the last two bytes of the A1 byte and the first two bytes of the A2 byte, are defined as the frame synchronization pattern (see the figure below).

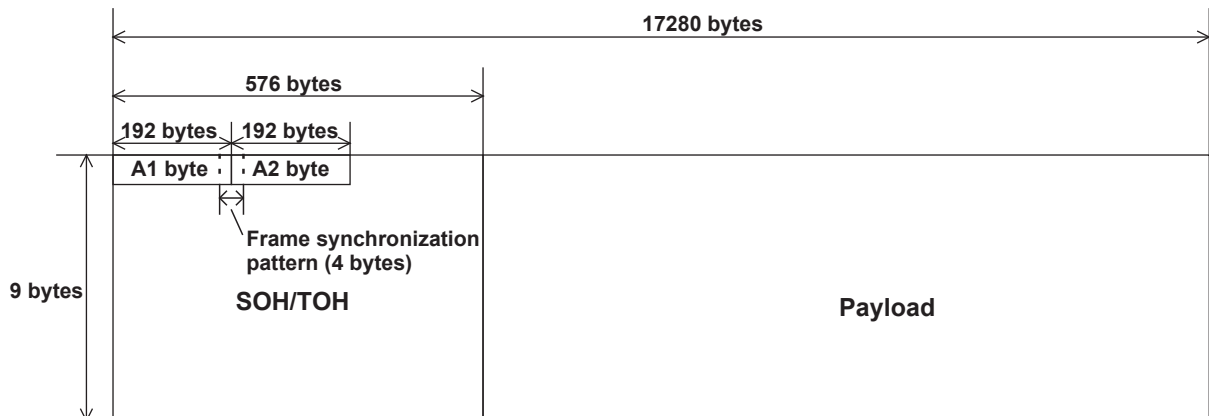

A1 byte: "F6F6F6---F6"h (192 bytes)

A2 byte: "282828---28"h (192 bytes)

**(\*2) Lead in payload patterns using the payload section as the synchronization means**

The synchronization conditions and method are the same as those for PRBS pattern measurement.

---

## 1.7 Optical Modulator Function

### Overview

This unit is a 10 Gbit/s-band optical modulation module (optical modulator) to be mounted on the AQ2200-series Frame Controller.

### Major Features

- This module is a compact optical modulation module<sup>1</sup> to be mounted on the AQ2200-series Frame Controller<sup>2</sup>.
- Applicable coding is NRZ and mark ratio is 1/2.
- An extinction ratio adjustment function is provided. The extinction ratio can be changed variably by adjusting the gain of the internal LN driver.
- A cross point adjustment function is provided. The cross point of the output waveform of the internal LN driver can be changed variably.
- An Auto Bias Control (ABC) ON/OFF function is provided. When this function is turned ON, the DC drift of the LN modulator can be corrected automatically. On the contrary, when this function is set at OFF, the DC bias can be set manually.
- An ABC Bias Slope switch function is provided. The polarity at the DC bias point of the LN modulator can be switched.
- This optical modulation module can easily be made applicable to the BER measurement of the 10 Gbit/s-band optical interface by combining it with the BERT module<sup>3</sup>, light source module<sup>4</sup>, and/or optical receiving module<sup>5</sup> of the AQ2200-series.
- By combining various modules of the AQ2200-series, a test system is constructed easily, in which the BERT is integrated with other applications.

- 1 AQ2200-621 10 Gbit/s Optical Modulator (1550 nm)  
AQ2200-622 10 Gbit/s Optical Modulator (1310 nm)
- 2 AQ2211 Frame Controller (3-slot type)  
AQ2212 Frame Controller (9-slot type)
- 3 AQ2200-601 10 Gbit/s BERT Module
- 4 AQ2200-111 DFB-LD Module
- 5 AQ2200-631 10 Gbit/s Optical Receiver

## Optical Modulator Block Diagram

The following shows the block diagram of this module.

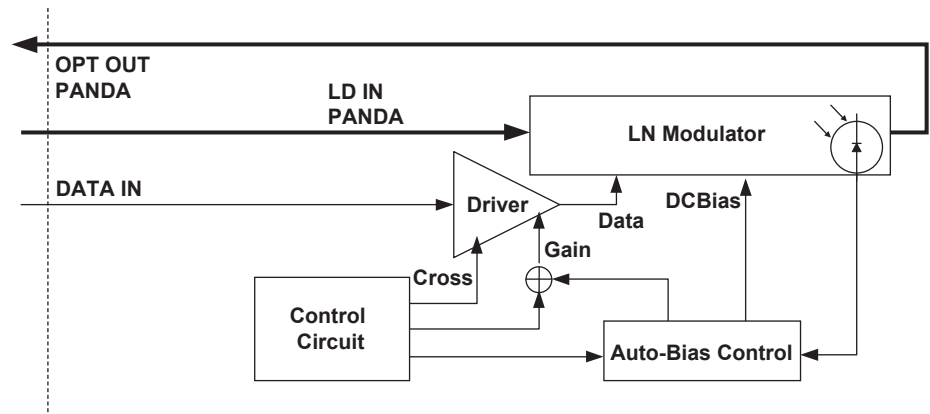

## Description of Block Diagram

This optical modulator uses Lithium Niobate (LN) (hereafter referred to as “LN modulator”).

The data input to the DATA IN terminal is amplified by the Driver to supply it to the LN modulator.

According to the above data, the intensity of the LD light, which is input from the LD INPUT terminal to the LN modulator, is modulated, and then it is output from the OPT OUT terminal.

The control circuit controls the Driver Gain (Gain shown in the above Fig.) and Driver output cross point (Cross shown in the above Fig.). With this operation, the light waveform is controlled indirectly.

The Auto Bias Control controls the feedback in order to automatically correct the DC drift of the LN modulator.

### Driver Gain

The output amplitude setting of the internal LN driver output waveform and set value are displayed using the numeric values and graphs.

As the output amplitude is changed, the extinction ratio can be changed.

The setting range is 0 to 255. "0" shows the amplitude decrease (extinction ratio decrease) direction while "255" shows the amplitude increase (extinction ratio increase) direction.

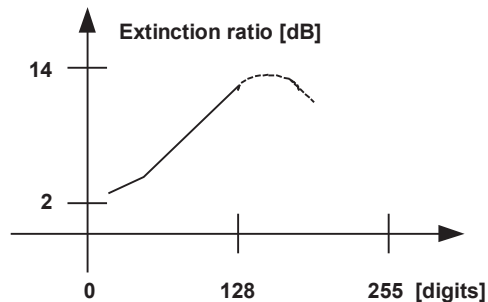

\* This shows a measurement example and does not guarantee the numeric values.

### Cross Point

The cross point setting of the internal LN driver and set value are displayed using the numeric values and graphs.

The cross point may depend on the ABC Slope.

The setting range is -31 to 32.

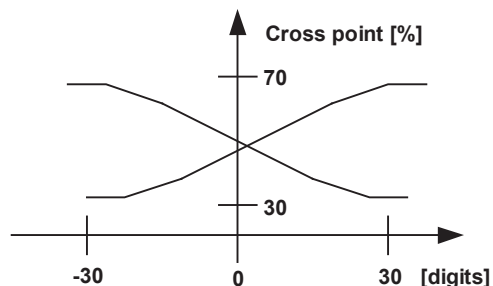

\* This shows a measurement example and does not guarantee the numeric values.

### ABC ON/OFF

The ON/OFF setting of the auto bias control (ABC: Auto Bias Control) circuit can be made to automatically correct the DC drift of the LN modulator.

When the ABC is set at ON, the ABC functions to automatically correct the DC drift of the LN modulator.

When the ABC is set at OFF, the ABC does not function, allowing you to manually set the DC bias.

## ABC Slope Change-over

When the ABC is set enabled, the polarity of the DC bias point of the LN modulator can be changed.

It is possible to set whether the ABC is locked on the Positive (+) side or Negative (-) side.

- **Positive**

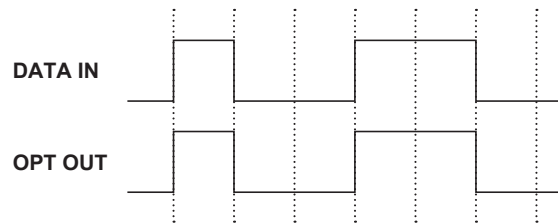

- **Negative**

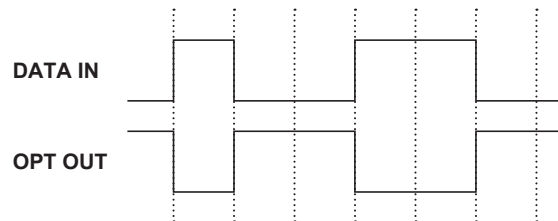

---

## 1.8 Optical Receiver Function

### Overview

This unit is a 10 Gbit/s-band optical receiving module (optical receiver) to be mounted on the AQ2200-series Frame Controller.

### Major Features

- This module is a compact optical receiving module<sup>1</sup> to be mounted on the AQ2200-series Frame Controller<sup>2</sup>.
- Applicable coding is NRZ and mark ratio is 1/2.
- A threshold value adjustment function is provided.
- An output ON/OFF function (operated only through GUI) is provided.
- Overload or Loss of signal is detected and LED on the front panel is lit.
- A simple power monitor function (-19 dBm to +5 dBm) is provided.
- This optical receiving module can easily be made applicable to the BER measurement of the 10 Gbit/s-band optical interface by combining it with the BERT module<sup>3</sup>, light source module<sup>4</sup>, and/or optical modulation module<sup>5</sup> of the AQ2200-series.
- By combining various modules of the AQ2200-series, a test system is constructed easily, in which the BERT is integrated with other applications.

1 AQ2200-631 10Gbit/s Optical Receiver

2 AQ2211 Frame Controller (3-slot type)  
AQ2212 Frame Controller (9-slot type)

3 AQ2200-601 10Gbit/s BERT Module

4 AQ2200-111 DFB-LD Module

5 AQ2200-621 10Gbit/s Optical Modulator (1550 nm)  
AQ2200-622 10Gbit/s Optical Modulator (1310 nm)

## Optical Receive Block Diagram

The following shows the block diagram of this module.

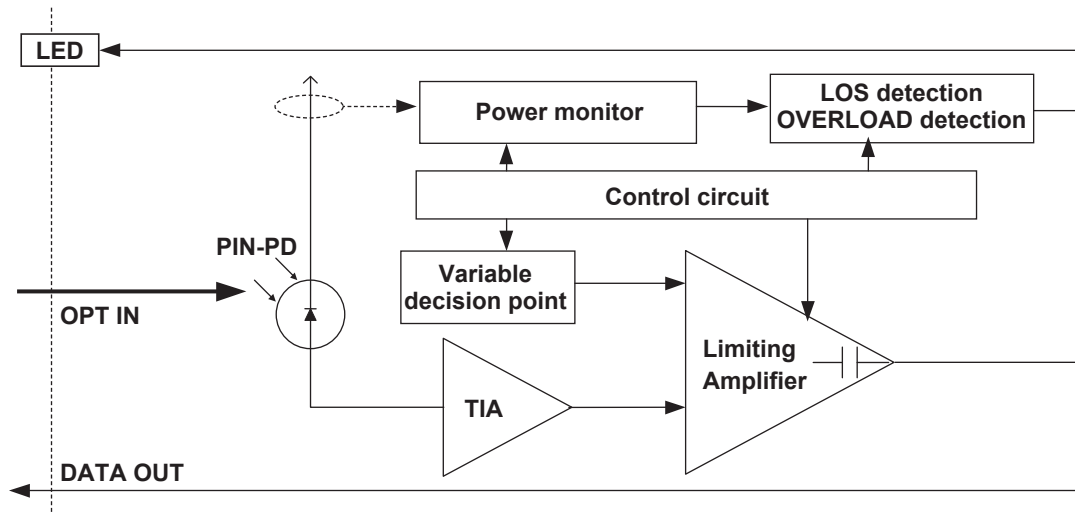

## Description of Block Diagram

The PIN-Photodiode (hereafter referred to as PIN-PD) is used as the optical receiver. The optical signal input via the OPT IN terminal is converted to an electric signal and amplified by the TIA (Transimpedance Amplifier).

This electric signal is identified at the preset threshold level (i.e. decision point) by the Limiting Amplifier in the next stage and output from the DATA OUT terminal as a digital signal.

The module is also equipped with a simple power monitor function, which monitors the optical current of the PIN-PD.

### Data Threshold

A threshold value is set to identify the logic to the electric data after completion of the optical-electric conversion.

Setting range: -364 to 273

The following Fig. shows an example of the BER measurement by changing the threshold value.

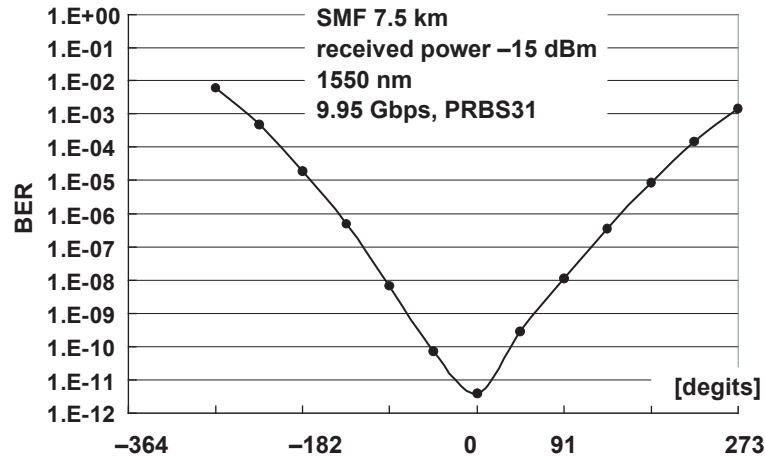

\* This shows a measurement example and does not guarantee the numeric values.

### Sets the Wavelength

A wavelength band (1.3  $\mu\text{m}$ /1.5  $\mu\text{m}$ ) of the receiving light signal is set. With this function, the wavelength band sensitivity of the Input Power Monitor described in (3) Input Power Monitor below is corrected.

### Power Monitor

Simple power monitor function.  
The average optical input power is displayed.

Measurement range: -19 dBm to +3 dBm

Note that the sensitivity correction by the temperature and wavelength within the wavelength band is not made strictly.

### Electric OUTPUT ON/OFF

The data output (i.e. electric output) from the DATA OUT port is turned ON/OFF.

### Setting Function of Overload Point and LOS Point

The detection levels for the Overload and LOS can be set.

- Overload point: -19 dBm to +2 dBm 0.1 dBm step
- LOS point: -19 dBm to +2 dBm 0.1 dBm step

### Detecting Function of Overload and LOS

The LED goes on if the value exceeds the Overload point or falls below the LOS point.



## 1.9 XFP Interface Functions

The XFP interface module can supply power to the XFP transceiver compliant with the MSA stipulations and write to its internal memory. You can also perform BER measurement of the XFP transceiver by combining the 10Gbit/s BERT module. You can connect a 10 Gbit/s XFP Transceiver, supply a power source, data communication clock, etc., and send or receive electrical signals from the optical transceiver. Through this XFP interface, you can perform BER measurements using BERT modules.

In addition to sending/receiving signals the XFP interface function can read alarm information such as for transceiver internal temperature and disconnection of the received signal.

### Power Supply

Four different DC voltages can be supplied: VCC5 (5 V), VCC3 (3.3 V), VCC2 (1.8 V), and VEE5 (-5.2 V).

### Setup/Control

#### Control of OPT OUT

Changes the XFP Transceiver output ON/OFF.

#### Control of Power Supply

Adjusting the Power Supply of XFP Transceiver: VCC5 (5 V), VCC3 (3.3 V), VCC2 (1.8 V), and VEE5 (-5.2 V).

### Alarm and Monitor

#### Displaying the Alarm

You can display alarm output from the XFP Transceiver.

- Mod\_NR(Module Not Ready)
- Rx\_LOS
- Interrupt

#### Monitor

Displays A/D converter values, temperature, and electric voltage inside the MSA compliant XFP transceiver. The following A/D values are monitored.

- Transmission bias current
- Optical output level
- Optical input level

---

## 1.10 Reference Clock Features (SG)

The SG module can generate a reference clock signal for evaluating a 10 Gbit/s optical transceiver.

Because there are five clock outputs, up to five optical transceivers can use the clock.

### **Clock Output ON/OFF**

You can turn the output channels ON/OFF. The output channels are turned ON/OFF simultaneously. If you set a channel that you do not want to use to Disable, its clock output will remain OFF regardless of whether you turn the channels on or off.

### **Frequency Setting**

There are two output rates. The rate determines the clock signal frequency, as indicated below.

Set the rate according to the optical transceiver's signal rate.

- 1/1: 620 to 720 MHz (offset: –500 to 500 ppm)
- 1/4: 155 to 180 MHz (offset: –500 to 500 ppm)

### **Output Amplitude**

You can switch between 0.6 Vp-p (fixed) and 1.1 Vp-p (fixed).

### **Synchronization with an External Measurement Device**

You can apply a 10 MHz reference signal to this unit and output a clock signal that is in sync with an external measurement instrument.

This unit can also generate a 10 MHz reference signal for an external measurement instrument to synchronize to.

## 1.11 Transceiver Interface Features

The transceiver I/F module has the following features.

- **Optical Transceiver Control and Monitoring**  
This unit controls and monitors power supplies and control signals.
- **Support for Various Optical Transceivers**  
This unit supports XENPAK, XFP, and SFP+ optical transceivers.
- **Access to the Transceiver Internal Memory**  
Using I2C/MDIO communication, this unit can write and read data from the optical transceiver internal ROM (only through the use of communication commands).  
I2C communication: XFP and SFP+ optical transceivers  
MDIO communication: XENPAK optical transceivers

### Power Supply and Power Supply Monitoring

The following five variable power supply types are available.

- 5 V (range: 4.750 to 5.250 V)
- 3.3 V (range: 3.135 to 3.465 V)
- 0.8 V (range: 0.800 to 1.890 V)
- -5.2 V (range: -5.460 to -4.940 V)
- 3.3/5.0 V (Select one or the other. The values are fixed.)

### Current Monitoring

This unit can monitor the current and display a message and stop output when the optical transceiver current consumption exceeds a preset limit.

This unit can monitor each power supply (PS1 to PS5) separately.

### Signal Control and Monitoring

There are 17 control signals (Ctrl01 to Ctrl17). You can set the logic levels (L/H) of all of them.

You can assign custom names to each control signal or assign names that correspond to the various optical transceiver types all at once.

There are six monitor signals (AIN01 to AIN06), and you can set the thresholds for the logic levels of each signal.

You can assign names to each monitor signal just as you can with the control signals.

# 2.1 Changing Displays

## Showing and Changing Displays

You can change the display by pressing the keys on the front panel of the frame controller.

This section explains how to show and switch between various displays.

### Procedure

#### Displaying the DETAIL Screen

Press **DETAIL** to display the DETAIL screen.

#### Displaying the SUMMARY Screen

press **SUMMARY** to display the SUMMARY screen.

#### Displaying the APPLICATION Screen

Press **APPLI** to display the APPLICATION screen.

#### Displaying the File Operation Window

Press **FILE** to display the file operation window.

#### Displaying the SYSTEM Screen

Press **SYSTEM** to display the SYSTEM screen.

#### Changing

Press the other keys to change each screen.

**DETAIL key**

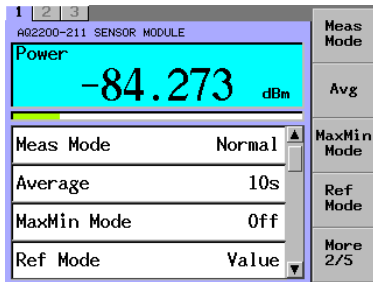

**DETAIL Screen**

**SUMMARY key**

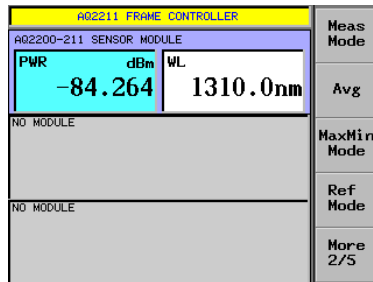

**SUMMARY Screen**

**APPLI key**

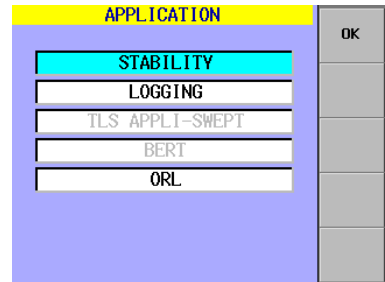

**APPLICATION Screen**

**FILE key**

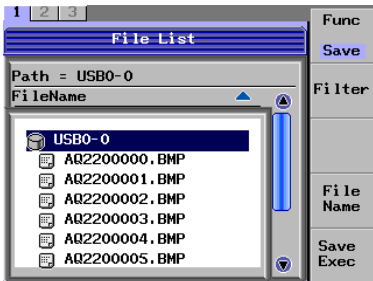

**File Operation Window**

**SYSTEM key**

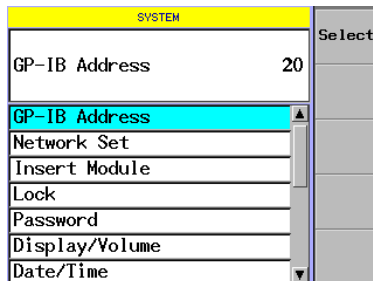

**SYSTEM Screen**

## 2.2 Changing the Module to Control (The current module)

### Procedure

#### Changing the Current Module

Press **SLOT(▶)**.

When you press **SLOT(▶)**, the slot number of the current module changes from slot 1 to slot 2 to slot 3 to slot 1, and so on (on the AQ2211).

On the AQ2212, the slot number changes from slot 1 to slot 2 to slot 3...to slot 9 to slot 1, and so on.

#### Note

- The slot where no module is mounted is skipped.
- When the SUMMARY screen is displayed, the current module is changed with the arrow keys.
- The current module changes in reverse order when you press the **SLOT(◀)** key.

#### SUMMARY Screen

AQ2211 FRAME CONTROLLER			Meas Mode
AQ2200-211 SENSOR MODULE			Avg
PWR	dBm	WL	
-70.224		1310.0nm	
AQ2200-141 FP-LD MODULE			MaxMin Mode
Opt		WL	
0n		1310.5nm	
NO MODULE			Ref Mode
			More 2/5



Every time the **SLOT** key is pressed, the current module is changed in the order of slot No.

AQ2211 FRAME CONTROLLER			Opt
AQ2200-211 SENSOR MODULE			ATT
PWR	dBm	WL	
-70.224		1310.0nm	
AQ2200-141 FP-LD MODULE			Mod Src
Opt		WL	
0n		1310.5nm	
NO MODULE			Mod Freq
			More 2/2

DETAIL Screen

Current module

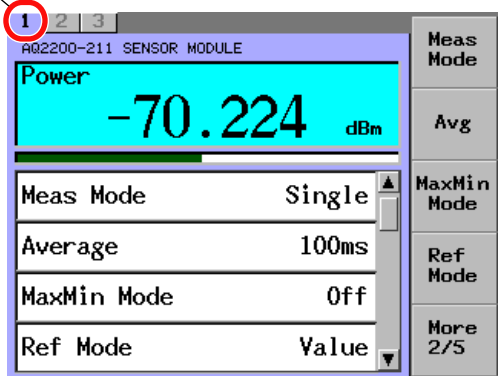

Every time the SLOT key is pressed, the current module is changed in the order of slot No.

Current module

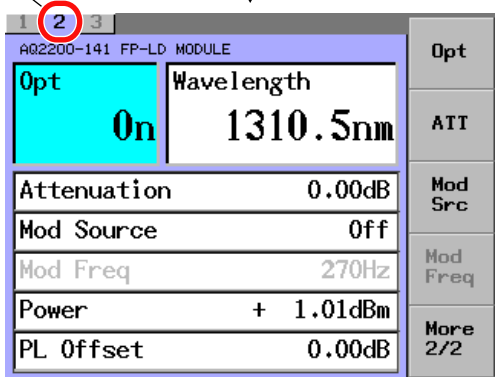

Changing the Device (Channel)

On modules equipped with multiple devices (channels), change the current device (channel) by following the procedure below.

1. After selecting the current module, use the arrow keys (◀, ▶) to select the device (channel).

SUMMARY Screen

Current device (channel)

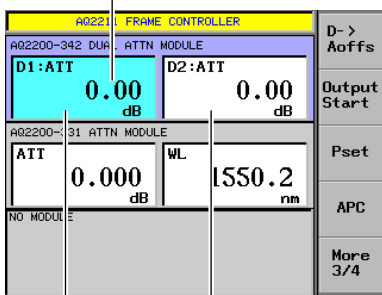

Device 1 (D1) Device 2 (D2)

DETAIL Screen

Current device (channel)

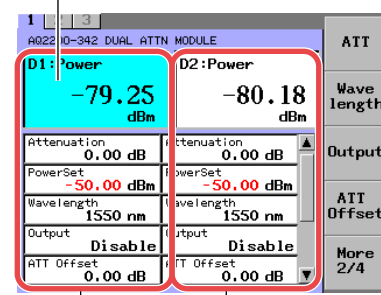

Device 1 (D1) Device 2 (D2)

## 2.3 Selecting Parameters and Changing Values

### Procedure

#### Selecting a Parameter

Two kinds of parameter selections are provided as shown below.

#### Selection with the Cursor

1. Use the arrow keys to move the cursor to the parameter that you want to change, and press **ENTER**.

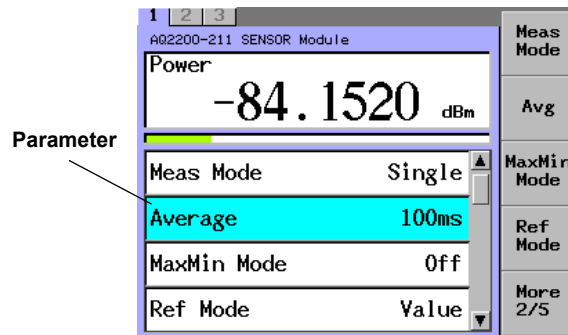

#### Selection with the Soft Key

1. Press the soft key that corresponds to the parameter that you want to change.

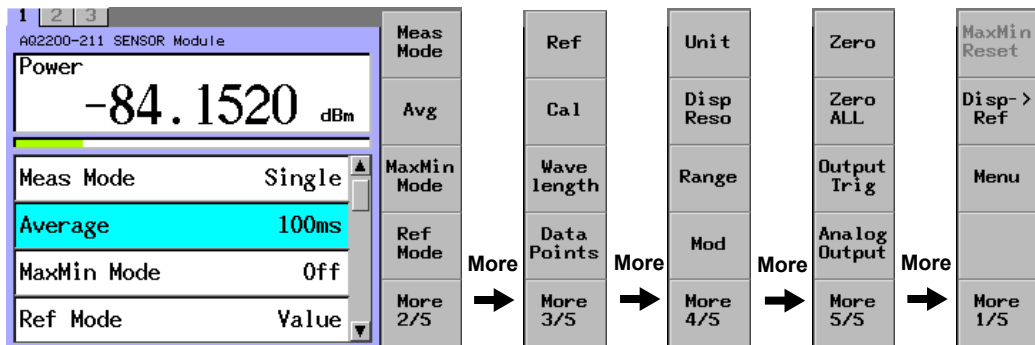

#### Note

Press the More soft key if you cannot find the soft key that you want to select.

**Selecting an Item**

2. Use the arrow keys to move the cursor to the item that you want to change, and press the **OK** soft key or **ENTER**.

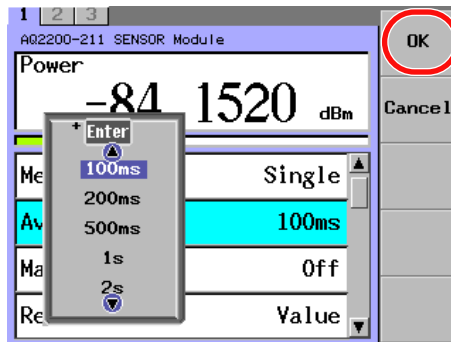
**Canceling the Contents of the Parameter during Setting**

3. Press **CANCEL** or the **Cancel** soft key.



## 2.3 Selecting Parameters and Changing Values

### Changing the Numeric Value

Two kinds of numeric value changing methods are provided as shown below.

#### Inputting a Numeric Value with the Arrow Key

1. With the arrow key (◀, ▶), move the cursor to a digit you want to change the numeric value.
2. Increase or decrease the numeric value with the arrow key (▲, ▼).
3. Repeat above steps 1 and 2 to change the numeric value to a value you want to input.
4. Press **ENTER** or the **OK** soft key.

Updated after pressing **ENTER**  
or the **OK** soft key

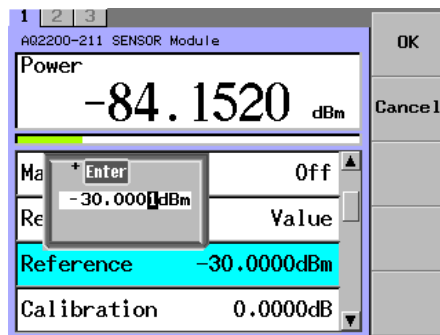

Updated immediately

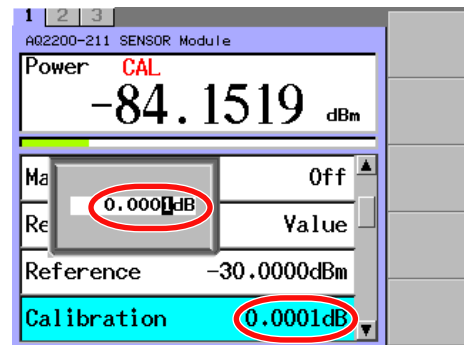

#### Note

- The value input is automatically limited so that it does not exceed the upper or lower limit value.
- The values of immediate input parameters are updated and reflected in the displayed measured values immediately.
- The numeric input values of the parameters other than the immediate input can be canceled by pressing the **CANCEL** key or the **Cancel** soft key.

### Inputting a Numeric Value with the Numeric Keypad

1. If a dialogue box for entering a value appears, press a key on the front panel that has a number on it. A numeric keypad will appear.
2. Enter a numeric value, then press **ENTER**.  
The numeric keypad and numeric entry dialog boxes will close simultaneously.

### When the Numeric Input Dialog Box Remains Displayed (for immediate input parameters)

3. Press **ENTER**.  
The numeric input dialog box disappears.

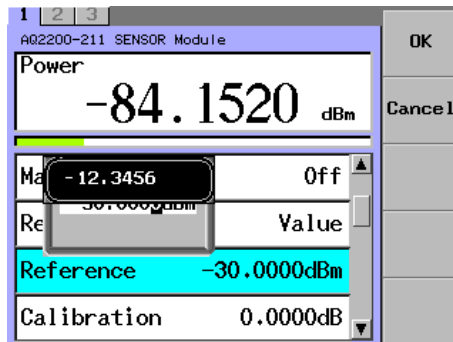

### Note

- After you press ENTER, if the value that you specified is beyond the upper or lower limit, the value will automatically be set to the limit that it is closest to.
- On the numeric keypad, the minus key is the SHIFT key.
- To correct the value, use the arrow key (◀) as back space (BS) key.

### Explanation

#### Immediate

The values of immediate input parameters are usually updated and reflected in the displayed measured values immediately.

However, these values are not updated immediately when they are input with the numeric keypad. These values are updated after you enter a measurement value and press the ENTER key.

## Returning Various Parameters to Their Initial Values

### Initializing Only the Current Module

1. Press the **Menu** soft key.  
The module control soft keys appear.
2. Press the **Module Preset** soft key to display Executing.  
When the display of Executing disappears, the initialization is completed.

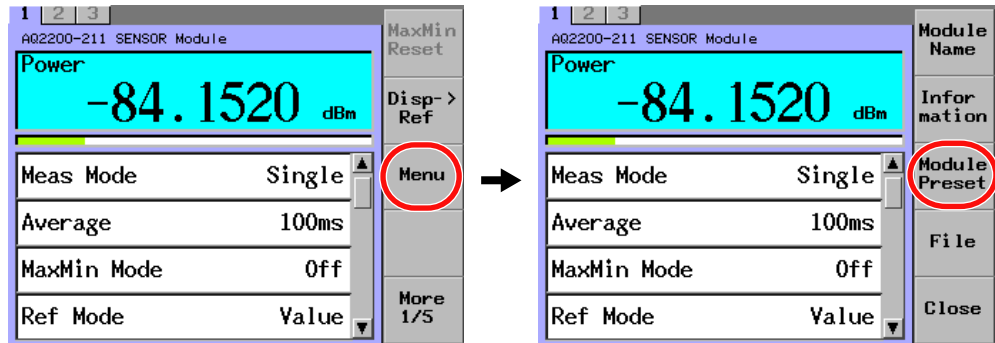

### Note

- The initialization process varies depending on the module.
- Start the initialization of AQ2200-612/622/631/641 from step 2.
- For details about initial values, see List of Default Settings, (page 13-21).

### Initializing All Modules

1. Press **PRESET** to display a dialog box for selecting what to initialize.
2. Use the arrow keys to move the cursor to an item that you want to initialize, and press **ENTER**.

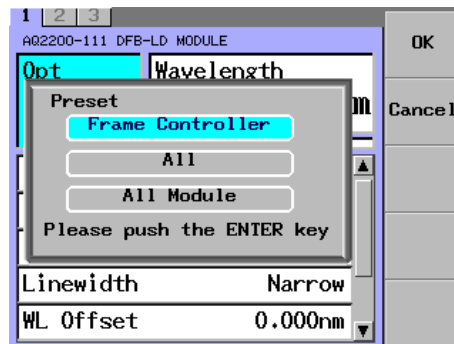

### Note

For initialization item, select any of three items shown below.

- Frame controller: Initializes the parameters of the frame controller.
- All: Initializes the parameters of the frame controller and all mounted modules.
- All Modules: Initializes the parameters of all mounted modules.

The initialization process varies depending on the module.

## 2.4 Inputting a Character String

### Inputting a Character String

#### Software Keyboard

As with file and module names, when you press a key that corresponds to a setup item that requires text input, a software keyboard appears.

#### Procedure

#### Inputting Text with the Soft Keyboard

1. Use the arrow keys to move the cursor to the character that you want to input, and press **ENTER**.

The selected character appears in the input box.

2. Press the **Commit** soft key to input the text.

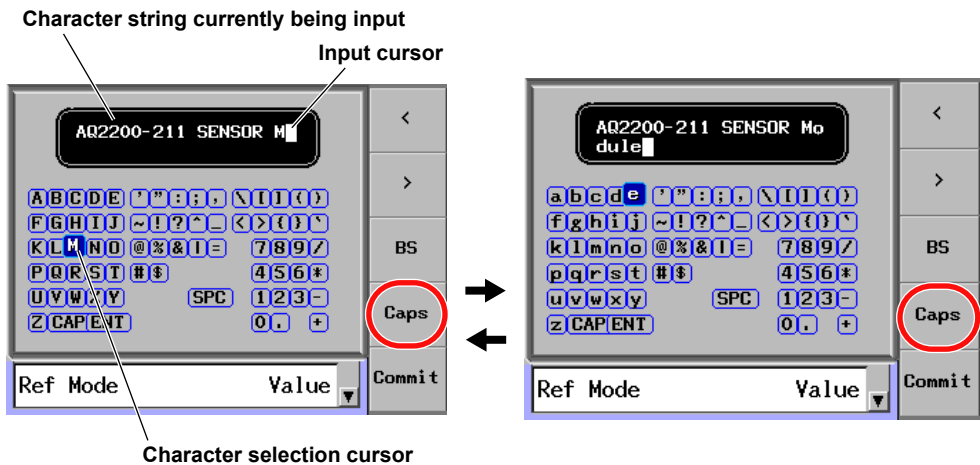

- <: Moves the input cursor to the left.
- >: Moves the input cursor to the right.
- BS: Deletes the character before the input cursor (Back Space).
- Caps: Switches between uppercase and lowercase letters.
- Commit: Confirms the text that has been input and closes the software keyboard.

- Arrow keys: Move the character selection cursor.
- Numeric keypad: Inputs a numeric value directly at the input cursor position.
- ENTER key: Inputs the character at the character selection cursor position to the input cursor position.
- CANCEL key: Ends text input.

# 3.1 Power Measurement by Optical Sensor Module

By mounting the following modules on this unit, you can measure the optical power.

- AQ2200-211 Sensor Module
- AQ2200-215 Sensor Module
- AQ2200-221 Sensor Module
- AQ2200-212 Sensor Module
- AQ2200-222 Dual Sensor Module
- AQ2200-201 Interface Module + AQ2200-231 Optical Sensor Head
- AQ2200-201 Interface Module + AQ2200-241 Optical Sensor Head
- AQ2200-202 Interface Module + AQ2200-232 Optical Sensor Head
- AQ2200-202 Interface Module + AQ2200-242 Optical Sensor Head

In the following descriptions, the operation screens of the AQ2200-211 and AQ2200-215 are used to explain the contents.

When using the AQ2200-221, AQ2200-222 Sensor Module or AQ2200-202 Interface Module, set each device separately while using the display examples in section 2.2 for reference. For AQ2200-221, parameters that can be set for more than one device can be set simultaneously on two devices.

### Display Examples

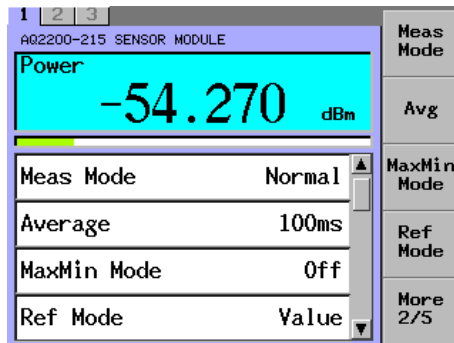

AQ2200-211/AQ2200-215 Sensor Module DETAIL Screen

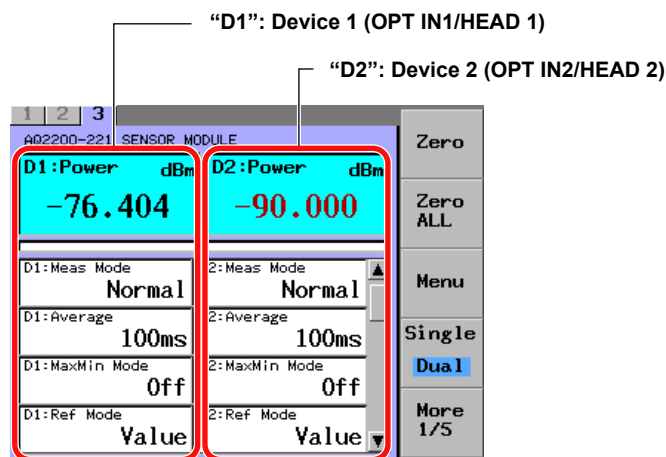

AQ2200-221/AQ2200-222/AQ2200-202 DETAIL Screen

### Note

If an optical sensor head is not connected to the AQ2200-202, "-----" is displayed.

### 3.1 Power Measurement by Optical Sensor Module

#### Soft Key Menu

Name	Function
MaxMin Reset	Resets the Max/Min measurement results <sup>1</sup> .
Disp->Ref	Sets the currently displayed measurement value to the reference value <sup>2</sup> .
Meas Mode	Selects the measurement mode(Normal/Single/Trigger).
Avg	Sets the Averaging time.
MaxMin Mode	Selects the Max/Min measurement mode.
Event	Sets event conditions <sup>3</sup>
Ref Mode	Selects a comparison object for the relative measurement.
Ref	Sets the reference value.
Cal	Sets the offset value.
Wavelength	Sets the wavelength value.
Data Points	Sets the number of data points of the Max/Min measurement.
Unit	Selects the Power Display Unit.
Disp Reso	Selects the Number of Power Display Digits.
Range	Selects the measurement range.
Mod	Selects the modulation mode <sup>4</sup> .
Zero	Executes the ZERO-SET of currently module.
Zero ALL	Executes the ZERO-SET of all installed sensor modules and AQ2200-331/332/342 ATTN modules.
Output Trig	Selects the trigger output on/off setting.
Analog Output	Selects the analog output mode <sup>5</sup> .
Menu	Information.
Single Dual	Switches between 1-ch setting and 2-ch simultaneous setting. (only for AQ2200-221)
Single Meas	Executes the Single Measure.
Log Save	Saves the power measured in Max/Min Mode <sup>6</sup> .
Save ImmDat	Saves the currently displayed measurement value to the USB storage.

The displayed order varies depending on the module.

- 1 For the AQ2200-221, AQ2200-222 and AQ2200-202, MaxMin Reset1 and MaxMin Reset2 can be reset separately for each device.
- 2 For the AQ2200-221, AQ2200-222 and AQ2200-202, Disp->Ref1 and Disp->Ref2 can be set separately for each device.
- 3 For modules other than the AQ2200-212, AQ2200-222 and AQ2200-202, Event is not displayed (cannot be set).
- 4 For the AQ2200-215, AQ2200-221, AQ2200-212, AQ2200-222 and AQ2200-202, Mod is not displayed (cannot be set).
- 5 For the AQ2200-221 and AQ2200-222, Analog Output is not displayed (cannot be set).
- 6 For modules other than the AQ2200-212, AQ2200-222 and AQ2200-202, Log Save is not displayed (cannot be set).

#### Switching Devices (With the AQ2200-221/AQ2200-222/AQ2200-202)

##### Procedure

1. Press the **Single Dual** soft key to move the cursor to Single.  
The cursor switches between Single and Dual each time you press the key.
2. Use the arrow keys to move the cursor to the side of the device that you want to configure. You can configure the device whose side the cursor is on.

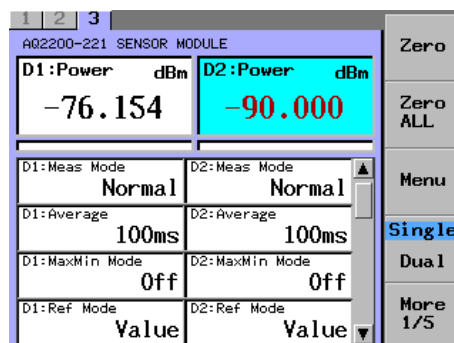

### Setting Both Devices at the Same Time(AQ2200-221)

1. Press the **Single Dual** soft key to move the cursor to Dual.
2. Use the arrow keys to move the cursor to the parameter that you want to set. You can only set a parameter for one device (device 1) if it is a parameter for which the same setting cannot be made on both devices (e.g., Output Trig).

### Changing the Power Display Unit

#### Procedure

1. Press **DETAIL** to display the DETAIL screen.
2. Use the **SLOT** keys to select the sensor module as the current module.
3. Press the **Unit** soft key or move the cursor using the arrow keys to Power and press **ENTER**.

The Unit dialog box will appear.

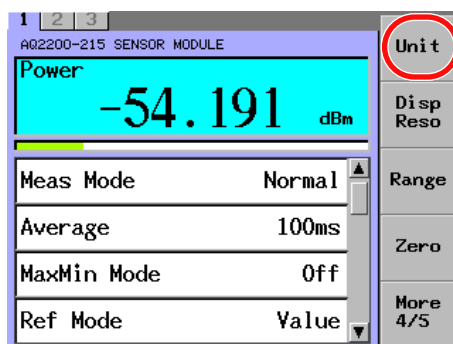

4. Move the cursor using the arrow keys to a desired display unit and press the **OK** soft key or **ENTER**.

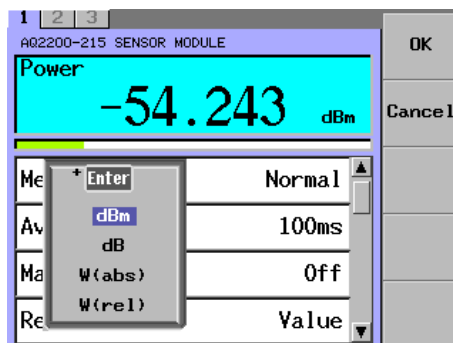

#### Note

This operation is discussed in the explanation of the DETAIL screen. You can also perform this operation on the SUMMARY screen.

#### Explanation

##### Changing the Power Display Unit

The power display unit is changed to “dBm”, “dB”, “W(abs)”, or “W(rel)”. “dBm” and “W(abs)” show the absolute value while “dB” and “W(rel)” show the relative value.

Additionally, the power display unit has the following relationship.

$$Pd_{\text{Binput}} = 10 \times \log (P_{\text{winput}}(W)/1 \times 10^{-3}(W))$$

where

$Pd_{\text{Binput}}$ : Optical input power (dBm)

$P_{\text{winput}}$ : Optical input power (W)

Furthermore, the display values have the following relationship.

$$Pd_{\text{Bdisplay}}(\text{dBm}) = Pd_{\text{Bm}}(\text{dBm}) + \text{CAL}(\text{dB})$$

$$P_{\text{wdisplay}}(W) = 10^{Pd_{\text{Bdisplay}}(\text{dBm})}/10 \times 10^{-3}$$

$$Pd_{\text{B}} = Pd_{\text{Bdisplay}}(\text{dBm}) - Pd_{\text{Bref}}(\text{dBm})$$

$$P_{\text{w}} = P_{\text{wdisplay}}(W)/P_{\text{wref}}(W)$$

where

$Pd_{\text{Bm}}$ : Measurement value (dBm) when set at “dBm”.

$Pd_{\text{Bdisplay}}$ : Measurement display value (dBm) when set at “dBm”.

$P_{\text{wdisplay}}$ : Measurement display value (W) when set at “W(abs)”.

$Pd_{\text{B}}$ : Measurement display value (dB) when set at “dB”.

$P_{\text{w}}$ : Measurement display value (no unit) when set at “W(rel)”.

CAL: Power offset value (dB)

$Pd_{\text{Bref}}$ : Relative reference value (dBm)

$P_{\text{wref}}$ : Relative reference value (W)

##### Note

- The power offset value is the offset value set in “Setting the Power Offset Value”. For details, see Setting a Power Offset Value (next page).
  - The relative reference value is the value shown in “Reference”. For details, see Setting the Reference Mode (page 3-6) and Setting a Reference Value (page 3-8).
-



### Setting a Power Offset Value

You can use a value, that a power offset value (-180.0000 to +200.0000 dB) is added to the measurement value, as the display value.

#### Procedure

1. Press **DETAIL** to display the DETAIL screen.
2. Use the **SLOT** keys to select the sensor module as the current module.
3. Press the **Cal** soft key or move the cursor using the arrow keys to Calibration and press **ENTER**.

A dialog box for setting the Calibration value will appear.

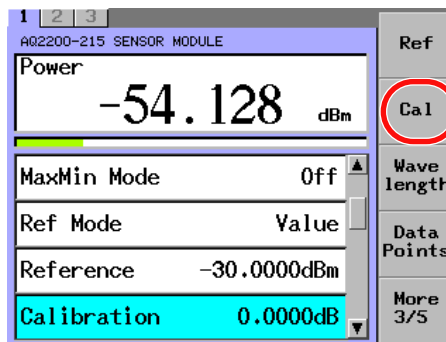

4. Change the numeric value with the numeric keypad or the arrow keys, and press **ENTER**.

At this time, when changing the numeric value with the arrow keys, the set value is then set immediately and it affects the displayed measurement value quickly.

When setting the power offset value, "CAL" will appear.

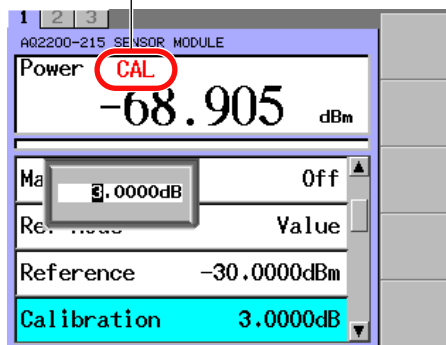

#### Note

The setting range is -180.0000 to +200.0000 dB.

Setting the Reference Mode

**Procedure**

1. Press **DETAIL** to display the DETAIL screen.
2. Use the **SLOT** keys to select the sensor module as the current module.
3. Press the **Ref Mode** soft key or move the cursor using the arrow keys to Ref Mode and press **ENTER**.

The Ref Mode dialog box will appear.

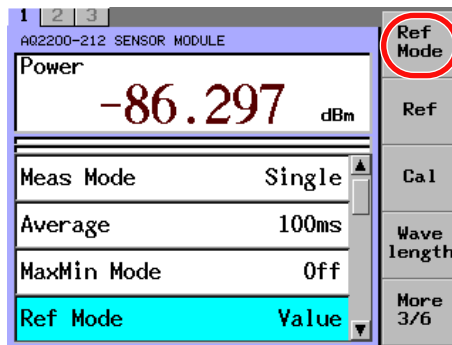

4. Press the **Value Sensor** soft key to switch between Value and Sensor.

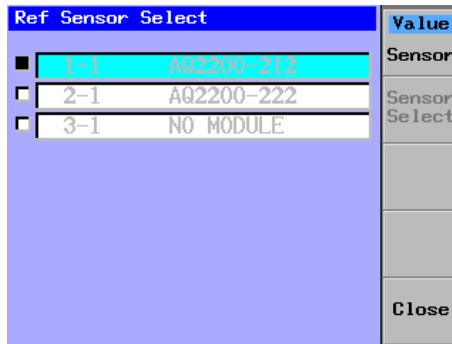

**When selecting Sensor**

5. Use the arrow keys to select a sensor from the list of sensors that can be made the object of relative measurement, and press the **Sensor** soft key or **ENTER**. If the device can be selected, use the arrow keys to move the cursor to the device number to measure and press the **OK** soft key or **ENTER**.

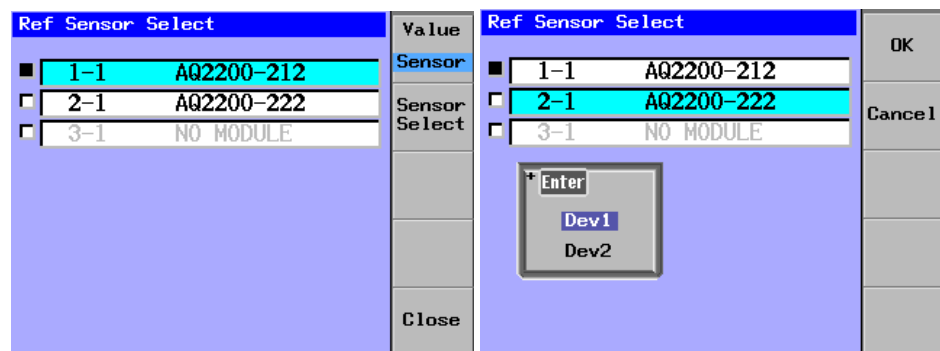

#### **Note**

When setting the reference mode, the relative measurement reference value is shown in the Reference field.

“Value” is set: Reference value set in the Reference soft key.

“Sensor” is set: Measurement value of the sensor specified for the relative measurement.

---

#### **Explanation**

During relative measurement, you can specify the reference.

When the display unit is set to “dB” or “W (rel)”, the relative measurement value is displayed in the Power display field.

Value setting: Relative measurement to desired reference value (dBm or W) set in Reference

Sensor setting: Relative measurement based on the measurement value of the sensor that has been chosen as the reference

#### **Note**

When the module specified in the Sensor is pulled out, the module with a minimum slot number is automatically selected.

---

### 3.1 Power Measurement by Optical Sensor Module

#### Setting a Reference Value

You can set a reference value when the reference mode is set at "Value".

Two kinds of reference value settings are provided as shown below. Use an optimal setting corresponding to the application.

- A desired value is input.
- The currently displayed measurement value is used for the reference value.

#### Procedure

##### Inputting a Desired Value

1. Press **DETAIL** to display the DETAIL screen.
2. Use the **SLOT** keys to select the sensor module as the current module.
3. Use the **Ref Mode** soft key or the arrow keys to set Ref Mode to Value.
4. Press the **Ref** soft key or move the cursor using the arrow keys to Reference and press **ENTER**.

A dialog box for setting the Reference value will appear.

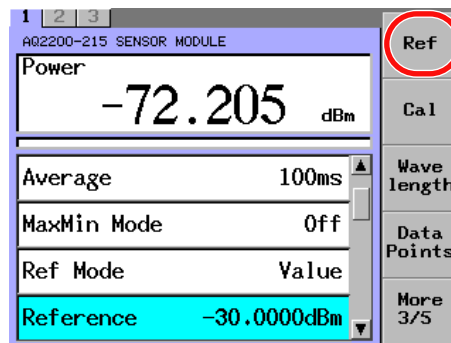

5. Change the numeric value with the numeric keypad or the arrow keys, and press the **OK** soft key or **ENTER**.

Additionally, to change the unit when the measurement display is W (abs) or W (rel), see steps 6.

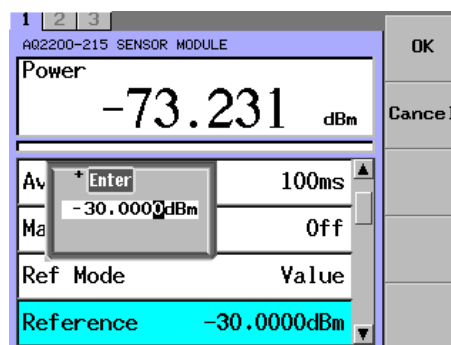

- Press the **Unit** soft key.  
A Unit selection dialog box appears.

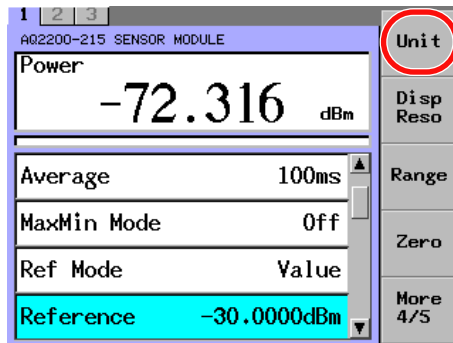

- Move the cursor to using the arrow keys a desired display unit and press the **OK** soft key or **ENTER**.

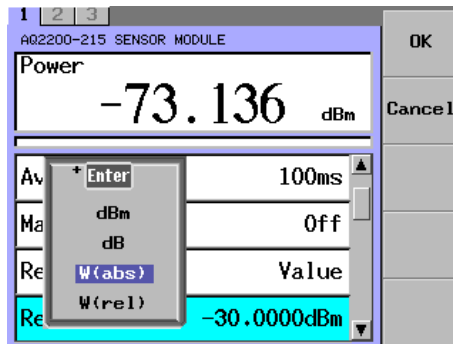

### 3.1 Power Measurement by Optical Sensor Module

#### Using the Currently Displayed Measurement Value for the Reference Value

1. Press **DETAIL** to display the DETAIL screen.
2. Use the **SLOT** keys to select the sensor module as the current module.
3. Press the **Disp->Ref** soft key.

When the AQ2200-221, AQ2200-222 sensor module or the AQ2200-202 Interface module is mounted, press the **Disp->Ref1** and **Disp->Ref2** soft key for the device 1 and device 2, respectively.

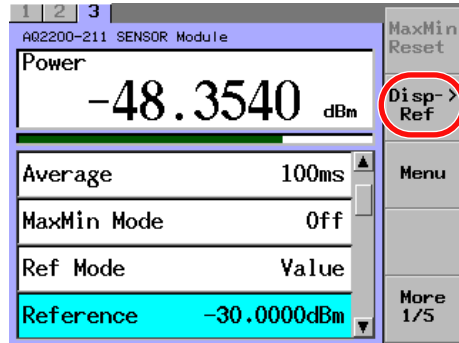

Operation Screen of AQ2200-211

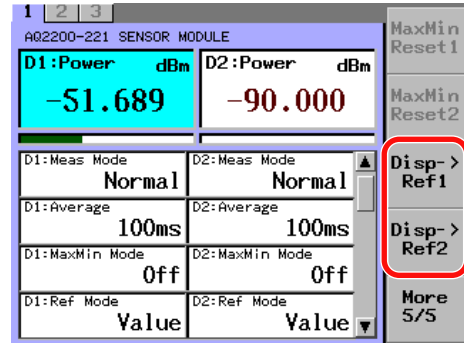

Operation Screen of AQ2200-221

The current measurement value is shown in the Reference field.

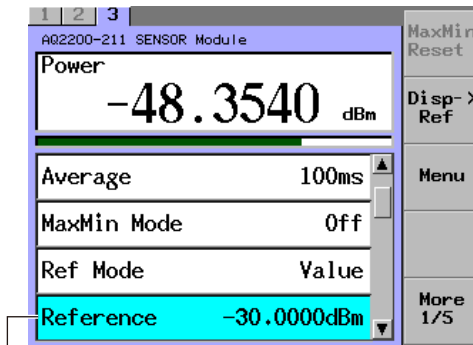

The current measurement value

#### Note

When the reference mode is Sensor, it is not possible to set it.

## Changing the Number of Power Display Digits

### Procedure

1. Press **DETAIL** to display the DETAIL screen.
2. Use the **SLOT** keys to select the sensor module as the current module.
3. Press the **Disp Reso** soft key or move the cursor using the arrow keys to Disp Reso and press **ENTER**.

A dialog box for setting the Disp Reso value will appear.

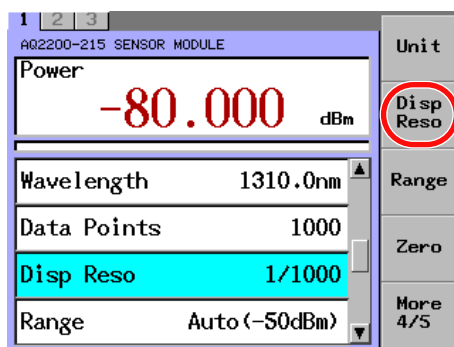

4. Move the cursor using the arrow keys to a desired number of decimal places and press the **OK** soft key or **ENTER**.

For units of W, the decimal point can move within the five valid number of digits, therefore there are times when the actual displayed digits are not the same as the specified digits.

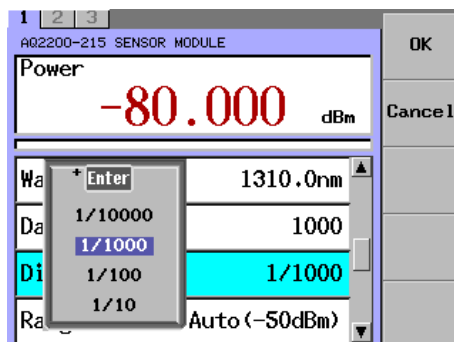

### Explanation

The power up to 1/10, 1/100, 1/1000, or 1/10000 decimal place can be displayed.

Select the necessary number of decimal places.

Note that the value at the least significant decimal place is made by rounding the value at the most significant decimal place that is not displayed.

### Changing the Measurement Wavelength

#### Procedure

1. Press **DETAIL** to display the DETAIL screen.
2. Use the **SLOT** keys to select the sensor module as the current module.
3. Press the **Wavelength** soft key or move the cursor using the arrow keys to Wavelength and press **ENTER**.  
The Wavelength dialog box will appear.

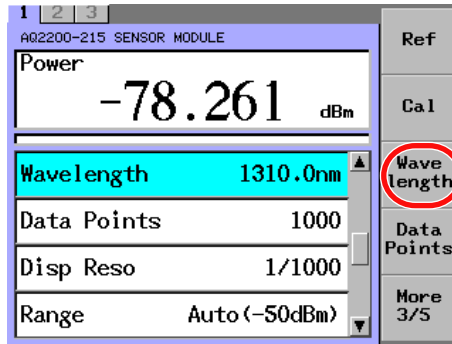

4. Change the numeric value using any of three operating procedures shown below and press the **OK** soft key or **ENTER**.

#### Changing the Numeric Value with the numeric keypad or the arrow keys

Use the numeric keypad or the arrow keys to change the value.

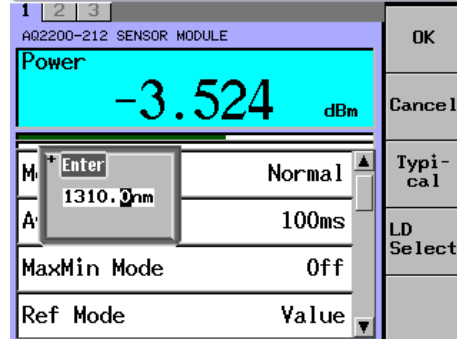

#### Changing the Numeric Value with the Function Key Typical

Press the **Typical** soft key repeatedly to sequentially change the wavelength typical value.

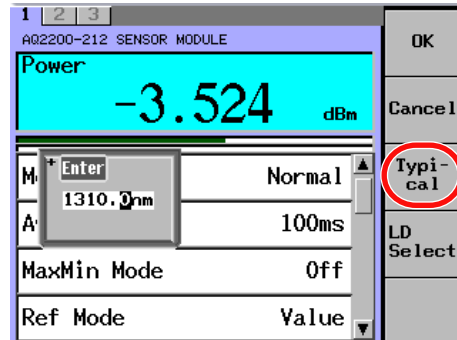



**Changing the Numeric Value with the Function Key LD Select**

When pressing the **LD Select** soft key, the wavelength values from the installed LS modules or the device are displayed. Use the arrow keys to move the cursor and select the wavelength value.

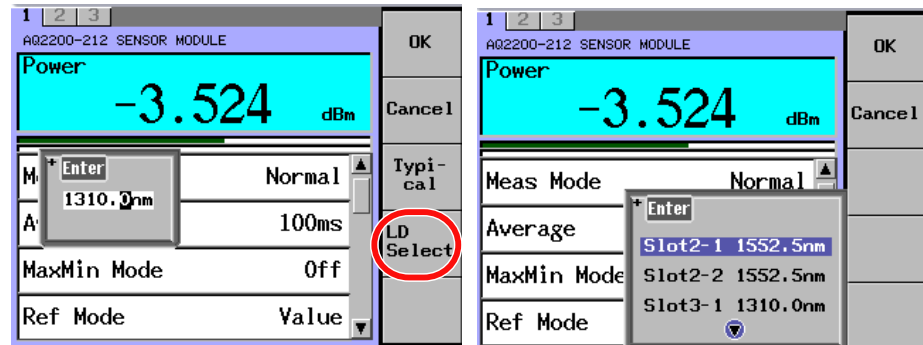
**Note**

- The setting range may vary depending on the model of the sensor.
- The following shows the typical values to be selected with the Typical soft key.
 

AQ2200-211 Sensor Module	:850.0 nm, 1300.0 nm, 1310.0 nm, 1550.0 nm
AQ2200-215 Sensor Module	:1300.0 nm, 1310.0 nm, 1550.0 nm
AQ2200-221 Sensor Module	:850.0 nm, 1300.0 nm, 1310.0 nm, 1550.0 nm
AQ2200-212 Sensor Module	:850.0 nm, 1300.0 nm, 1310.0 nm, 1550.0 nm
AQ2200-222 Dual Sensor Module	:850.0 nm, 1300.0 nm, 1310.0 nm, 1550.0 nm
AQ2200-231 Optical Sensor Head	:850.0 nm, 1300.0 nm, 1310.0 nm, 1550.0 nm
AQ2200-232 Optical Sensor Head:	850.0 nm, 1300.0 nm, 1310.0 nm, 1550.0 nm
AQ2200-241 Optical Sensor Head:	850.0 nm
AQ2200-242 Optical Sensor Head:	850.0 nm
- The LD Select soft key is not shown if there is no light source to be set.

**Explanation**

The optical input element has the wavelength sensitivity distribution. By setting the wavelength of the measurement light, the wavelength correction function of the sensor functions correctly to accurately measure the optical power.

### Changing the Measurement Mode

Three kinds of measurement modes are provided.

- Normal: Measurement is always performed to update the measurement value at any time.
- Single: Measurement is performed once and the measurement value is updated after completion of the measurement.
- Input Trigger: Measurement is performed by the trigger input and the measurement value is updated after completion of the measurement.

Select an optimal measurement mode corresponding to the measurement application.

### Procedure

1. Press **DETAIL** to display the DETAIL screen.
2. Use the **SLOT** keys to select the sensor module as the current module.
3. Press the **Meas Mode** soft key or move the cursor using the arrow keys to Meas Mode and press **ENTER**.  
A measure mode selection dialog box appears.  
Alternatively, in Single mode, each time pressing the **Single Meas** soft key, a measurement is performed and the measurement value is updated.

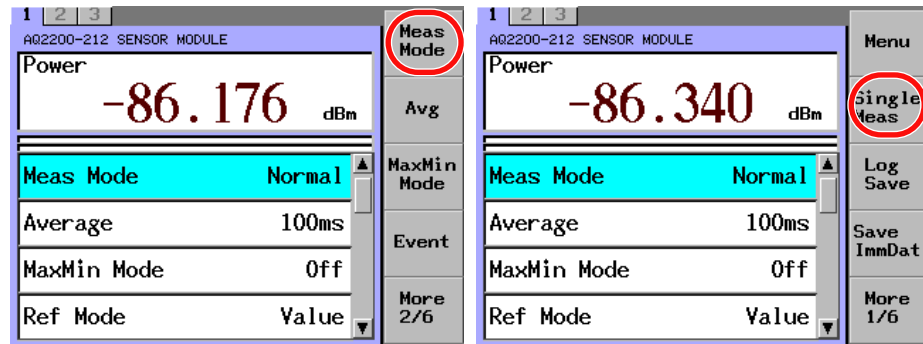

4. Move the cursor using the arrow keys to a desired measurement mode and press the **OK** soft key or **ENTER**.  
In Normal and Single mode, measurement starts, and the measurement data in the Power column is updated. In Input Trigger mode, the device enters into a wait-for-trigger state.

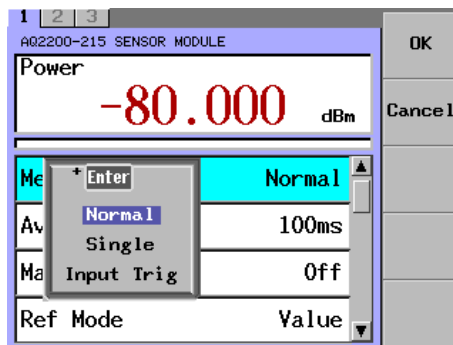

### Note

- For details about how to input the trigger, see section 8.1 in the IM735101-04EN.
- If an optical sensor in Single or Input Trigger mode receives a new Single-mode start or trigger input signal while it is measuring, it will stop the current measurement and start a new measurement.
- The measurement is performed only once in the Single or Input Trigger. After that, the measurement is not started until the Normal or Single is started or the trigger is input.
- When "Input Trigger" is set for both the device 1 and device 2 in the AQ2200-221, the average time setting is changed to a time longer than the value, which has already been set for the device 1 or device 2. Additionally, if the averaging time is changed in this status, the time settings of both the device 1 and device 2 are also changed.

## Changing the Averaging Time

The data of the time set in this section is averaged to one measurement data.

Note that the allowable averaging time may vary depending on the modulation setting.

### Procedure

1. Press **DETAIL** to display the DETAIL screen.
2. Use the **SLOT** keys to select the sensor module as the current module.
3. Press the **Avg** soft key or move the cursor using the arrow keys to Average and press **ENTER**.

A dialog box for setting the Average value will appear.

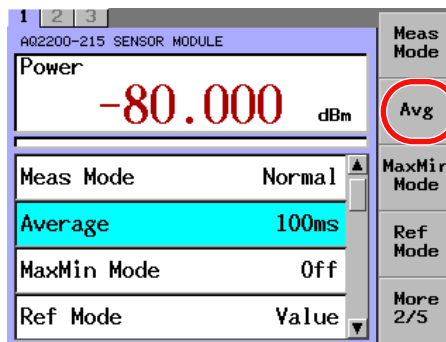

4. Move the cursor using the arrow keys to a desired averaging time and press the **OK** soft key or **ENTER**.

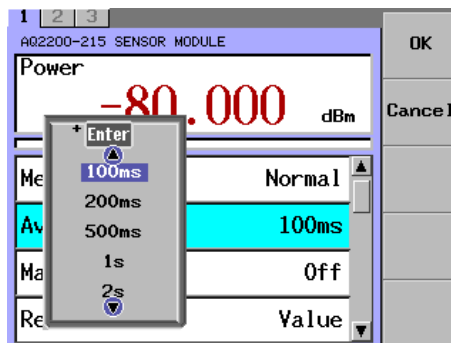

### 3.1 Power Measurement by Optical Sensor Module

---

#### Explanation

When the measurement mode is Normal, the first measurement value is prepared during the specified averaging time, and after that, moving averages are used to update the measurement value.

When the measurement mode is Single or Input Trigger, the first measurement value is prepared during the specified averaging time after the optical sensor receives a new Single-mode start or trigger input signal.

When you execute Max/Min measurement, the measurement value is updated at intervals of the averaging time.

#### Averaging Time by Modulation Setting

Averaging time	CW setting	CHOP setting
100 $\mu$ s	Yes	—
200 $\mu$ s	Yes	—
500 $\mu$ s	Yes	—
1 ms	Yes	—
2 ms	Yes	—
5 ms	Yes	—
10 ms	Yes	—
20 ms	Yes	—
50 ms	Yes	Yes
100 ms	Yes	Yes
200 ms	Yes	Yes
500 ms	Yes	Yes
1 s	Yes	Yes
2 s	Yes	Yes
5 s	Yes	Yes
10 s	Yes	Yes

#### Note

- For the AQ2200-215 sensor module, only for CW, the selectable range is 100  $\mu$ s to 10 s.
- For the AQ2200-221 sensor module, only for CW, the selectable range is 200  $\mu$ s to 10 s.
- For the AQ2200-212/222 sensor modules, only for CW, the selectable range is 100  $\mu$ s to 10 s.
- For the AQ2200-202 interface module, only for CW, the selectable range is 100  $\mu$ s to 10 s.
- When switching from CW mode to CHOP mode, if the averaging time is invalid in chop mode (e.g. 100  $\mu$ s to 20 ms), the averaging time is automatically set to 50 ms.
- When setting the averaging time to 100  $\mu$ s to 50 ms, if MaxMin mode is set to Window, the averaging time automatically sets to 100 ms(except for AQ2200-202/212/222).

### Displaying the Maximum Value and Minimum Value of the Measurement Value

The following four kinds of modes (Max/Min modes) can be set for totaling of the maximum value and minimum value.

- Continuous
- Window
- Refresh
- Event Trigger (only for AQ2200-202, AQ2200-212 and AQ2200-222)
- Off

Additionally, MAX (maximum value), MIN (minimum value), and Difference (maximum value - minimum value) can be checked on the DETAIL screen.

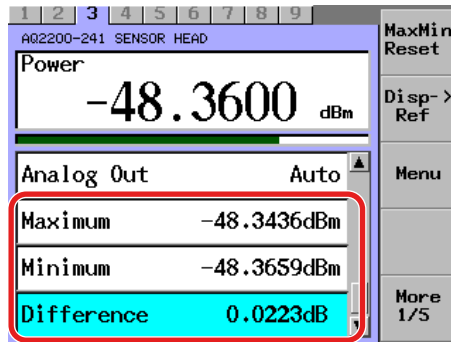

### Procedure

1. Press **DETAIL** to display the DETAIL screen.
2. Use the **SLOT** keys to select the sensor module as the current module.
3. Press the **MaxMin Mode** soft key or move the cursor using the arrow keys to MaxMin Mode and press **ENTER**.

A MaxMin Mode selection dialog box appears.

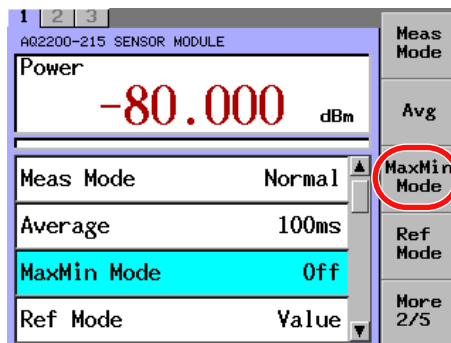

### 3.1 Power Measurement by Optical Sensor Module

#### Modules other than AQ2200-202, AQ2200-212 and AQ2200-222

4. Move the cursor using the arrow keys to a desired mode and press the **OK** soft key or **ENTER**.

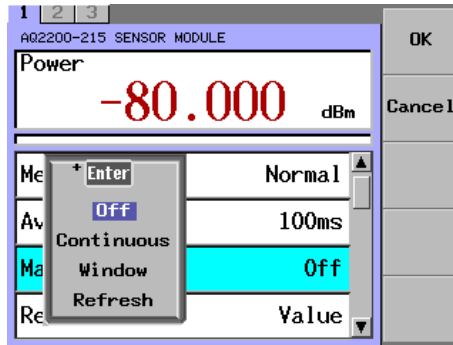

#### Clearing the Values during Measurement of Max/Min Values

When pressing the **MaxMin Reset** soft key, Max, Min, and Difference are cleared, and then the measurement is started again (restarted).

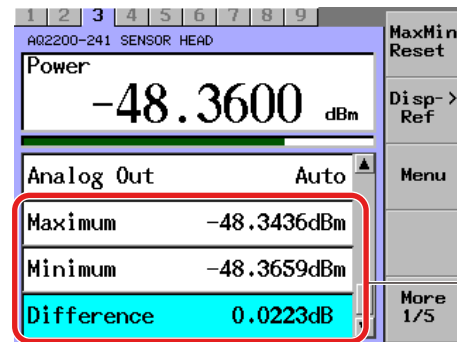
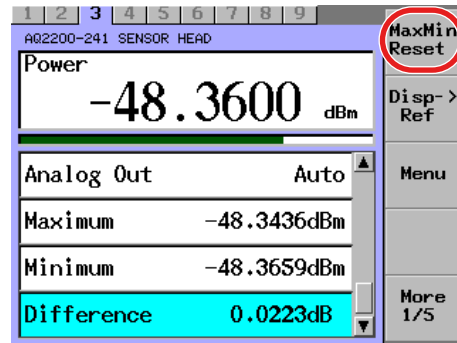

The current values are shown in the "Maximum" and "Minimum" fields, and then the value in the "Difference" field is cleared.

#### Setting the Number of Data Points

The number of measurement data points (1 to 20000) to be used in the Window mode and Refresh mode of the Max/Min measurement can be set for the data points.

5. Press **DETAIL** to display the DETAIL screen.
6. Use the **SLOT** keys to select the sensor module as the current module.

- Press the **Data Points** soft key or move the cursor using the arrow keys to Data Points and press **ENTER**.  
The Data Points dialog box will appear.

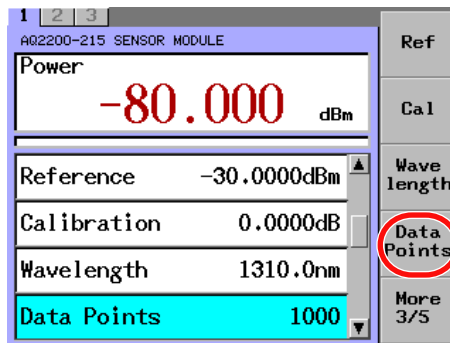

- Change the numeric value with the numeric keypad or the arrow keys, and press the **OK** soft key or **ENTER**.

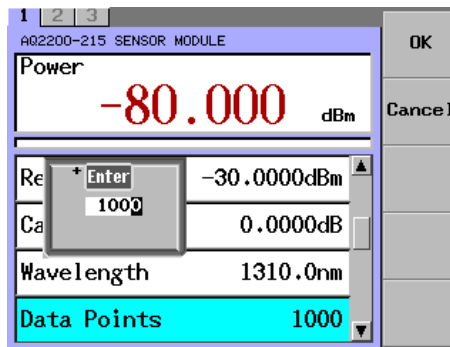

**Note**

For AQ2200-221, the number of data points setting becomes 1 to 10000.

**AQ2200-202, AQ2200-212 and AQ2200-222**

- Move the cursor using the arrow keys to **Max/Min Mode**, and press **ENTER**.  
A Max/Min Mode list appears.
- Move the cursor using the arrow keys to a desired mode, and press the **OK** soft key or **ENTER**.

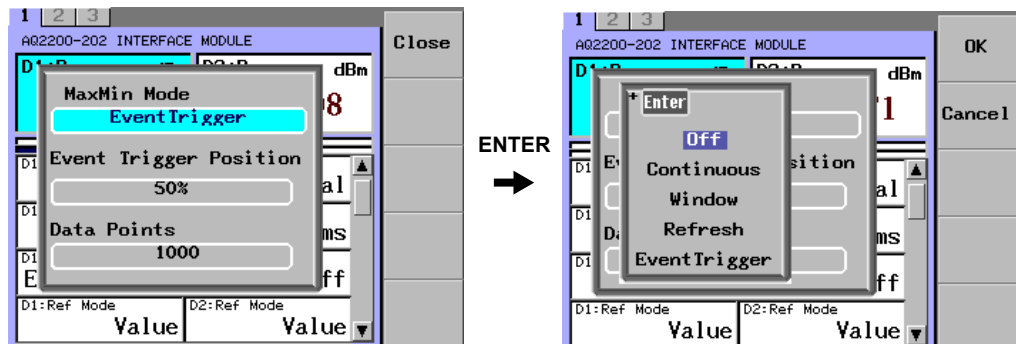

### 3.1 Power Measurement by Optical Sensor Module

#### Setting the Event Trigger Position (When Max/Min Mode Is Event Trigger)

6. Move the cursor using the arrow keys to **Event Trigger Position**, and press **ENTER**.

The Event Trigger Position dialog box will appear.

7. Move the cursor using the arrow keys to 0%, 50%, or 100%, and press the **OK** soft key or **ENTER**.

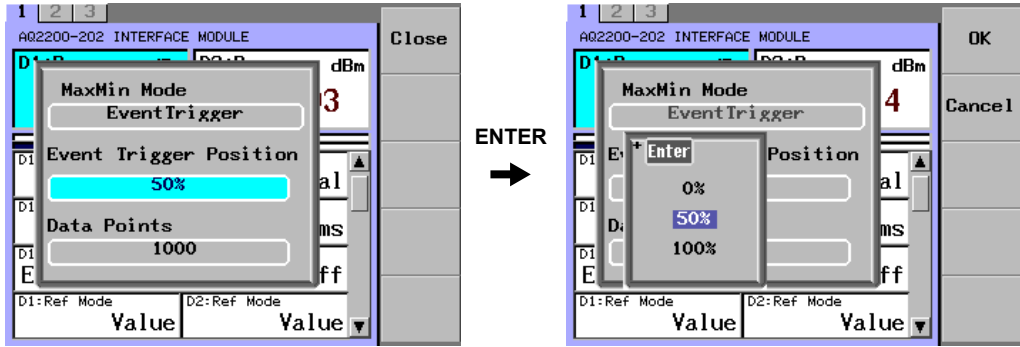

#### Setting the Number of Data Points

For Data Points, set the number of data points (1 to 20000) to measure in Window mode, in Refresh mode, and with event triggers during Max/Min measurement.

8. Move the cursor using the arrow keys to **Data Points**, and press **ENTER**.

The Data Points dialog box will appear.

9. Change the value using the numeric keypad or the arrow keys, and press the **OK** soft key or **ENTER**.

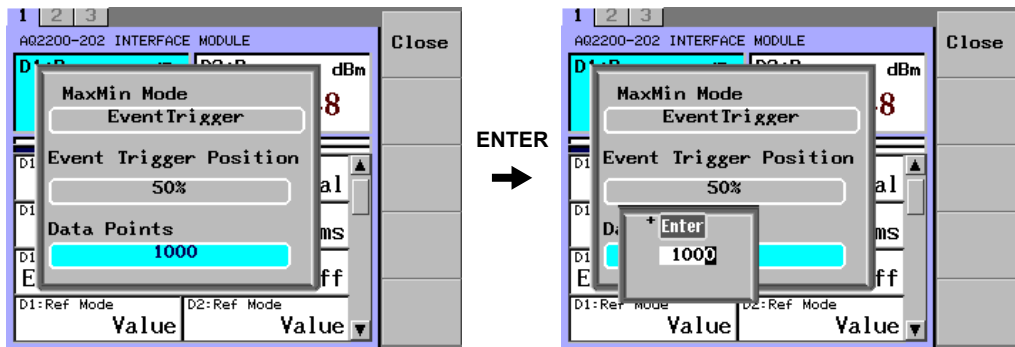

#### If Max/Min Mode Is Set to Event Trigger

If Max/Min mode is set to Event Trigger, set the threshold level and event position.

10. Press the **Event** soft key.

The Event dialog box will appear.

Event Type is fixed to Threshold Cross Over.

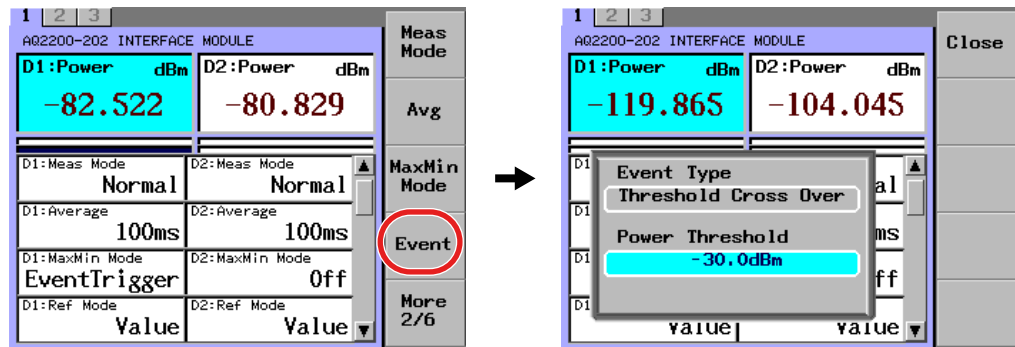



11. Move the cursor using the arrow keys to **Power Threshold**, and press **ENTER**.  
The Power Threshold dialog box will appear.
12. Change the value using the numeric keypad or the arrow keys, and press the **OK** soft key or **ENTER**.

**Explanation**

**Measurement of Maximum/Minimum Value**

When measuring polarization dependent loss, etc., the maximum and minimum values are measured, and the difference between them is calculated. Measurement intervals can be selected with the following 4 modes (5 for the AQ2200-202/212/222) for updating the maximum and minimum values.

- Continuous: The maximum value, minimum value, and (maximum value - minimum value) are updated every time the measurement value is updated between the mode setting and mode OFF.

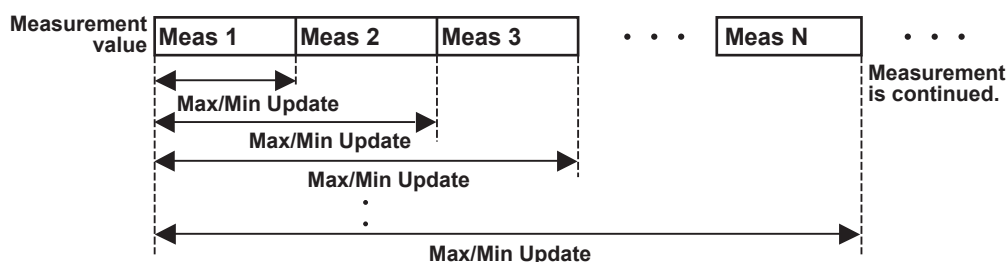

- Window: The maximum value, minimum value, and (maximum value - minimum value) are calculated from the measurement values of sample quantity specified in "Data Points". For data, the latest measurement value is taken to update the measurement value while disposing of the oldest measurement value.

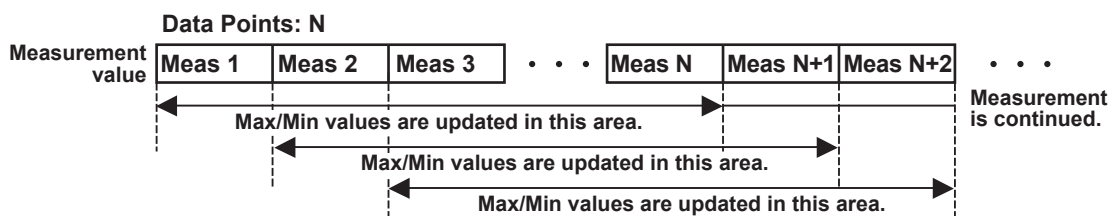

After measurement starts, if the number of samples specified by Data Points is not reached, the maximum value, the minimum value, and the difference between the two are displayed based on the measurement values up to that point.

- Refresh: This is the same as in Continuous mode, but after measuring the number of samples specified under "Data Points," measurement stops.

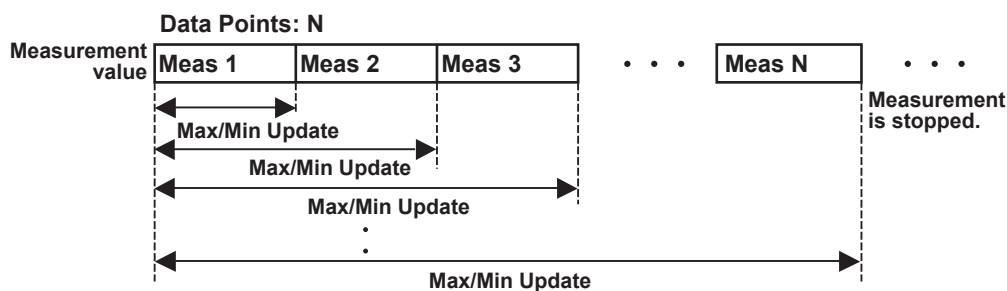

### 3.1 Power Measurement by Optical Sensor Module

---

- Event Trigger: This can be set only for the AQ2200-202/212/222. Incidents of measured values crossing the Power Thresh value set with Event are considered events. Measurements are made according to the Event Position setting for the number of samples specified by Data Point, and then the measurement stops.
  - 0%: Measurements are made with the first data as the trigger point, and the maximum value and minimum value are calculated.
  - 50%: Measurements are made with the center of Data Point as the trigger point, and the maximum value and minimum value are calculated.
  - 100%: Measurements are made with the end of the data as the trigger point, and the maximum value and minimum value are calculated.

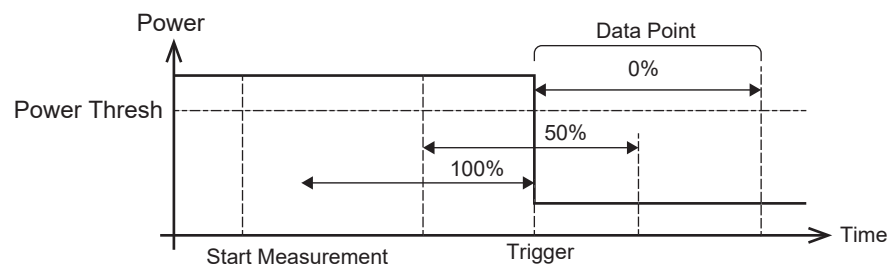

- Off: The modes set are turned OFF.  
Unless "OFF" is set, the above modes will not be cancelled.

#### **Note**

---

- When the Normal measurement is executed in the Refresh mode, Meas Mode is set to Single after the measurement.
  - When the Max/Min mode is set to Off, Meas Mode is automatically set to Normal.
  - For details about the number of Data Points, see Setting the Number of Data Points (page 3-18).
-

## Changing the Measurement Range

The measurement range can be set in steps of 10 dB. A measurement range can be selected from two modes described below.

- AUTO range: An optimal range is set automatically corresponding to the input optical power. Normally, this mode is used.
- HOLD range: A measurement range can be set manually.

### Note

The measurement range currently being measured in the AUTO range mode is shown in brackets next to the AUTO in the Range field on the screen.

## Procedure

1. Press **DETAIL** to display the DETAIL screen.
2. Use the **SLOT** keys to select the sensor module as the current module.
3. Press the **Range** soft key or move the cursor using the arrow keys to Range and press **ENTER**.

The Range dialog box will appear.

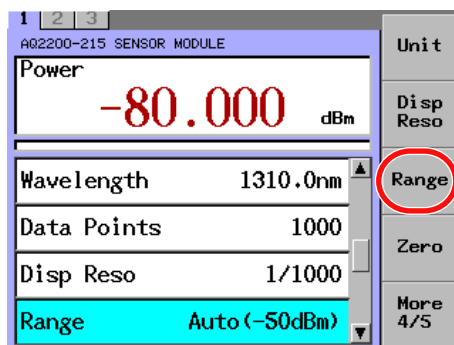

### Setting the Mode to AUTO Range

4. Press the **Auto** soft key.

### Setting the Mode to HOLD Range

4. Move the cursor using the arrow keys to a desired range and press the **OK** soft key or **ENTER**.

The procedure is the same for changing from auto range to hold range.

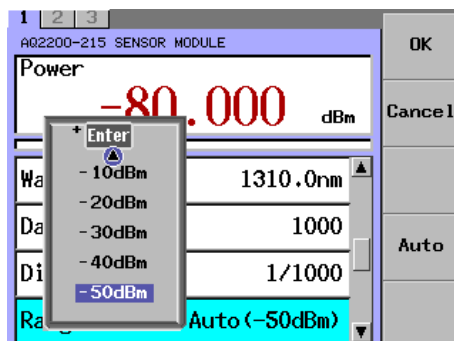

### 3.1 Power Measurement by Optical Sensor Module

#### Explanation

When using the HOLD range, pay special attention so that the optical input power must be within the range during operation.

The optical input power status within the range can be checked through the range bar. The range bar shows the currently input power graphically. The left end shows the lower limit of the range while the right end shows the upper limit.

If the measurement display value is shown in orange, this shows the measurement range-over. If it is shown in dark brown, this shows the measurement range-under. An optimal measurement range is selected so that the measurement value is shown in black, that is, normal color. And if the measurement display value is shown in gray, it means that averaging is in progress.

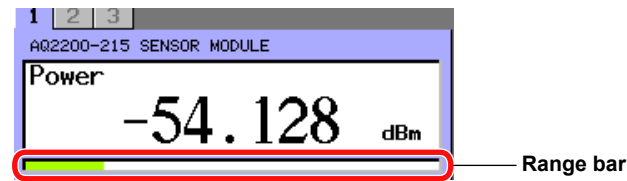

Range Bar on DETAIL Screen

Only the AQ2200-212/222 have two-step threshold for optical input. When the first threshold is exceeded, OVER flashes in red in the power display. If the second threshold is exceeded, an error dialog will be displayed.

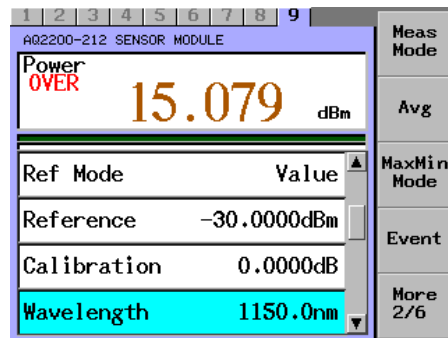

## Changing the Modulation Mode (CW/CHOP)

To accurately measure the optical power, you must set the modulation mode corresponding to that of the optical input.

For the modulation mode, the CW light or CHOP (DUTY 50%) modulation light can be selected. Additionally, select an optimal CHOP modulation light from 270 Hz, 1 kHz, or 2 kHz.

Two kinds of modulation mode setting methods are provided. Select a desired setting method corresponding to the application.

### Procedure

#### Setting through the Panel of the Sensor Module

Press **CW CHOP** on the sensor panel to change CW/CHOP.

#### Setting through the Panel of the Frame Controller

1. Press **DETAIL** to display the DETAIL screen.
2. Use the **SLOT** keys to select the sensor module as the current module.
3. Press the **Mod** soft key or move the cursor using the arrow keys to Modulation and press **ENTER**.

The Modulation dialog box will appear.

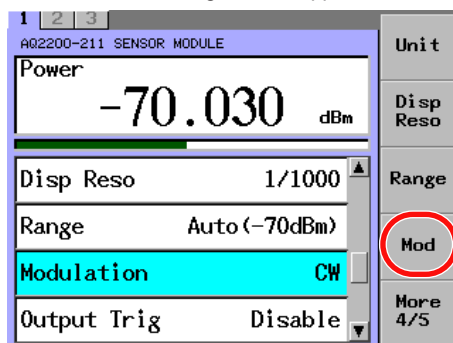

4. Move the cursor using the arrow keys to a desired mode and press the **OK** soft key or **ENTER**.

Additionally, when CHOP is set, the LED on the sensor panel is lit.

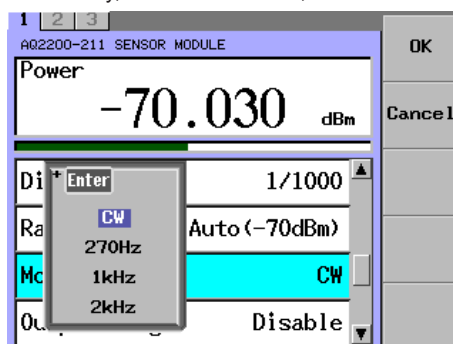

### Note

- If the CW light is received in the CHOP mode, the following message appears on the screen.  
Error 1265:OPT Mode Error
- If the CW light is received in the CHOP mode, the modulation mode error occurs.  
Make the setting of the modulation corresponding to the optical input.
- The AQ2200-215 sensor module does not support CHOP light.
- The AQ2200-221 sensor module does not support CHOP light.
- The AQ2200-212/222 sensor modules do not support CHOP light.
- The AQ2200-202 interface module does not support CHOP light.
- A mode error occurs if the chop mode frequency is not suitable. Enter modulation settings that correspond to the optical input.

### 3.1 Power Measurement by Optical Sensor Module

#### Starting the ZERO-SET

When performing the ZERO-SET, the electrical offset inside the sensor is adjusted, allowing you to accurately measure the absolute value.

Two kinds of ZERO-SET modes are provided as described below.

Select a desired mode to execute the ZERO-SET corresponding to your need.

- Zero: Starts the ZERO-SET of the current module.
- Zero ALL: Perform a ZERO-SET of all installed sensor modules and AQ2200-331/332/342 ATTN modules.

#### Procedure

#### Setting through the Panel of the Sensor Module (Other than AQ2200-221 / AQ2200-212 / AQ2200-222 / AQ2200-202 Module)

1. Firmly mount the optical shield cap on the optical receiving connector on the sensor you want to perform the ZERO-SET.
2. Press **ZERO** on the sensor panel to start the ZERO-SET.  
The following screen appears while the ZERO-SET is being performed. (When the DETAIL screen.)

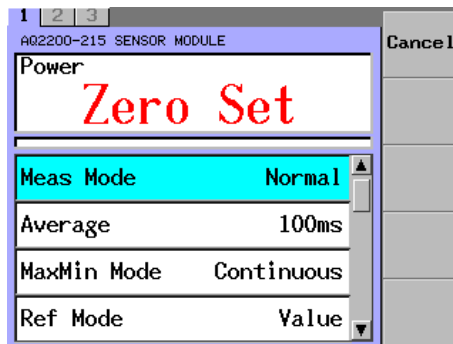

When the ZERO-SET is completed, the screen is returned to the previous screen.

#### Note

When pressing the ZERO key before the zero-set is completed, the operation stops and zero-set is cancelled.

#### Setting through the Panel of the Frame Controller (Other than AQ2200-221 / AQ2200-222 / AQ2200-202 Module)

1. Firmly mount the optical shield cap on the optical receiving connector on the sensor you want to perform the ZERO-SET.
2. Press **DETAIL** to display the DETAIL screen.
3. Use the **SLOT** keys to select the sensor module as the current module.
4. Press either the **Zero** or **Zero ALL** soft key to start the ZERO-SET.  
When the ZERO-SET is completed, the screen is returned to the previous screen.

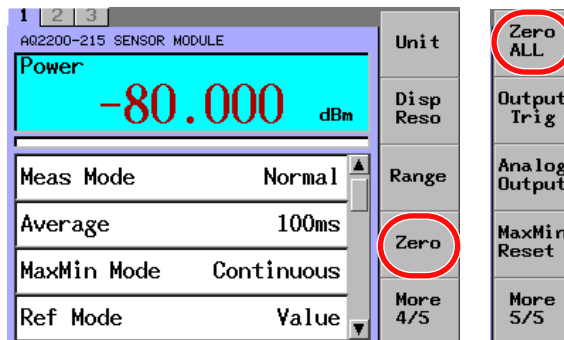

### Setting through the Panel of the Frame Controller (AQ2200-221, AQ2200-222 Sensor Modules and AQ2200-202 Interface Module)

1. Firmly mount the optical shield cap on the optical receiving connector on the sensor you want to perform the ZERO-SET.
2. Press **DETAIL** to display the DETAIL screen.
3. Use the **SLOT** keys to select the sensor module as the current module.
4. Move the cursor using the arrow keys to a device you want to perform the ZERO-SET, and then press either the **Zero** or **Zero ALL** soft key.

The ZERO-SET is started.

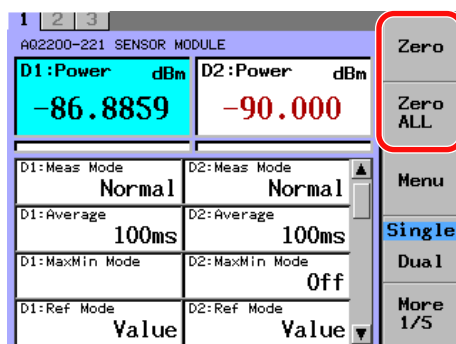

The character, Zero Set, appears while the ZERO-SET is being performed.

When the ZERO-SET is completed, the screen is returned to the previous screen.

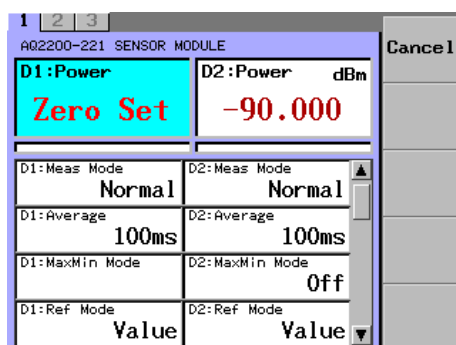

#### Note

- If the optical interruption is insufficient, the following message appears on the screen.  
Error 1263:Zero set Error1  
If this occurs, perform the optical interruption firmly and restart the ZERO-SET.
- When pressing the Cancel soft key before the ZERO-SET operation is not completed, the operation stops and zero-set is cancelled.

Setting the Analog Output

**Procedure**

1. Press **DETAIL** to display the DETAIL screen.
2. Use the **SLOT** keys to select the sensor module as the current module.
3. Press the **Analog Output** soft key or move the cursor using the arrow keys to **Analog Out** and press **ENTER**.  
The Analog Out dialog box will appear.

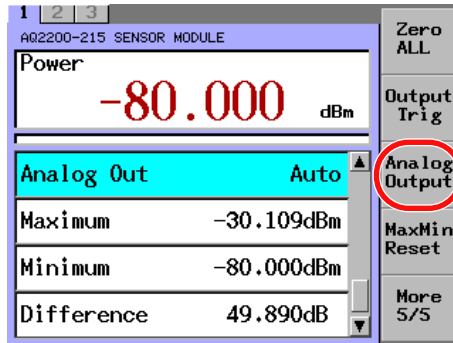

4. Move the cursor using the arrow keys to **Analog Out Mode** and press **ENTER**.  
An analog output mode selection dialog box appears.

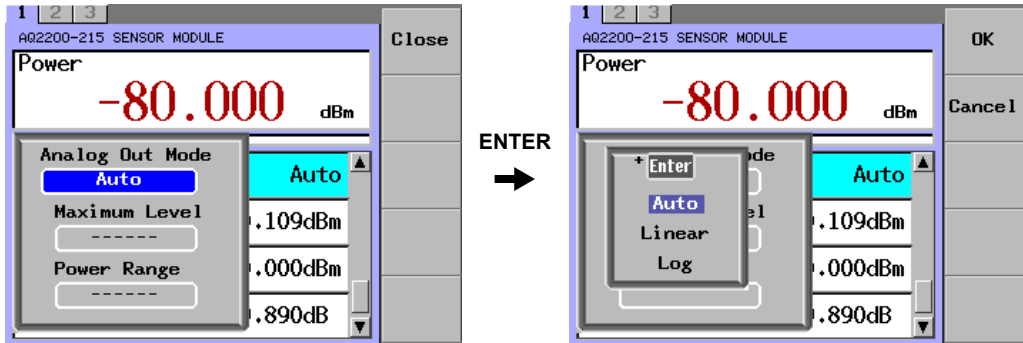

AQ2200-202 and AQ2200-212

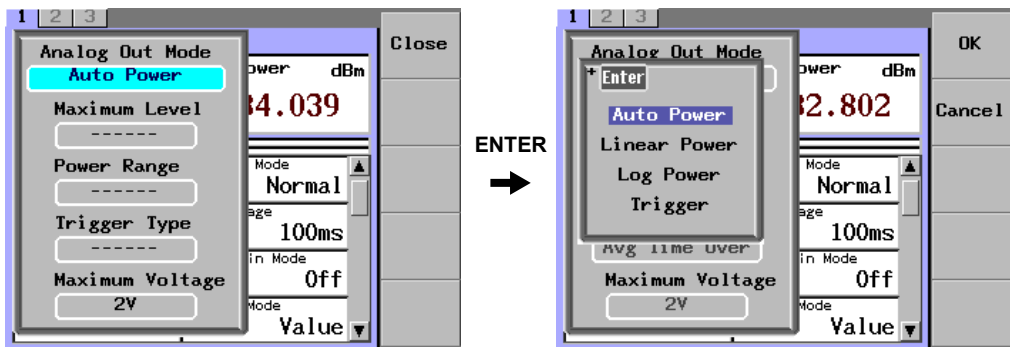



### Specifying the Level and Range Manually

You can specify settings manually when you set the analog output mode to Linear/Linear Power or Log/Log Power.

- Just as in step 4, use the arrow keys to move the cursor to **Linear/Linear Power** or **Log/Log Power**, and press **ENTER**.

A dialog box appears in which you can set the Maximum Level and the Power Range.

### Setting the Maximum Level

- Use the arrow keys to move the cursor to **Maximum Level**, and press **ENTER**. A dialog box for setting the Maximum Level value will appear.
- Use the numeric keypad or the arrow keys to change the value, and press the **OK** soft key or **ENTER**.

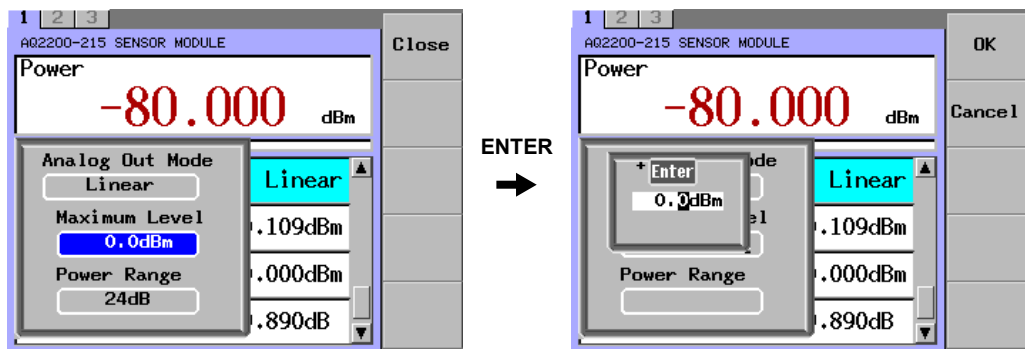

### Setting the Power Range

- Use the arrow keys to move the cursor to **Power Range**, and press **ENTER**. A dialog box for setting the Power Range value will appear.
- Use the numeric keypad or the arrow keys to change the value, and press the **OK** soft key or **ENTER**.

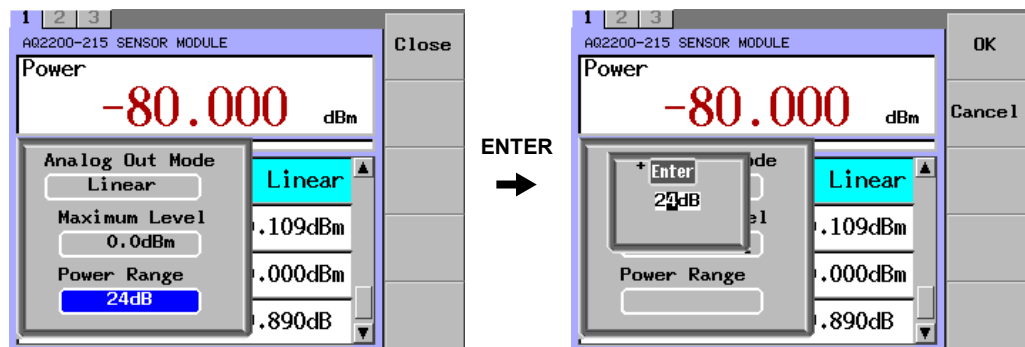

### Note

The AQ2200-221, AQ2200-222 sensor modules are not applicable to the Analog Out function.

### 3.1 Power Measurement by Optical Sensor Module

#### Setting the Trigger Type (AQ2200-202 and AQ2200-212)

When analog output mode is set to Trigger, you can set the trigger type.

5. Move the cursor using the arrow keys to **Trigger**, and press **ENTER**.
6. Move the cursor using the arrow keys to **Trigger Type**, and press **ENTER**.  
The Trigger Type dialog box will appear.
7. Use the arrow keys to set Trigger Type, and press the **OK** soft key or **ENTER**.

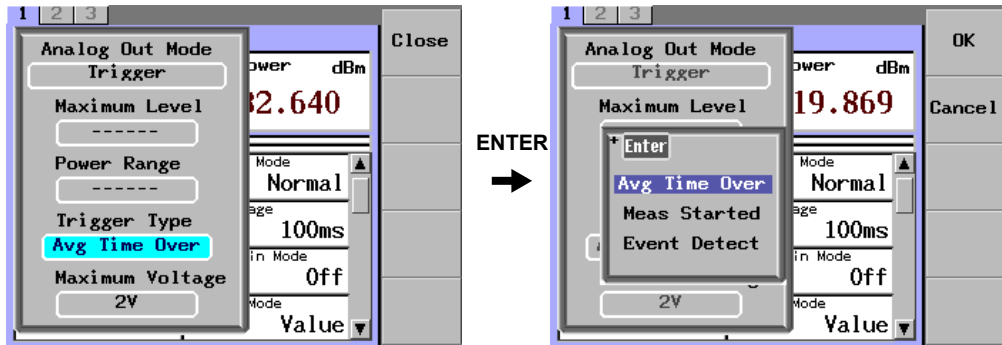

#### Setting the Maximum Voltage (AQ2200-202 and AQ2200-212)

Set the analog output's maximum voltage.

5. Set the analog output mode.
6. Move the cursor using the arrow keys to **Maximum Voltage**, and press **ENTER**.  
The Maximum Voltage dialog box will appear.
7. Use the arrow keys to select **2V** or **5V**, and press the **OK** soft key or **ENTER**.

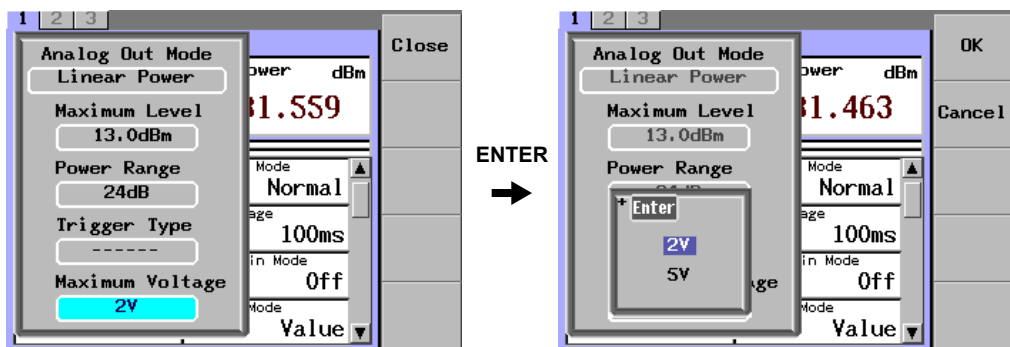

## Explanation

## Setting the Analog Output

The analog output function outputs voltages from the analog output terminal on the front panel according to the analog output mode.

This enables analog output that corresponds to the input optical power in real time (voltage output of approximately 0 to 2 V. With the AQ2200-202/212, voltage output ranging from approx. 0 to 5 V is also possible.). The following three modes (four for the AQ2200-202/212) are available for analog output. Select the mode most suitable for your application.

- **AUTO mode:** For outputting voltages of approximately 0 to 2 V or approximately 0 to 5 V (AQ2200-202/212) for each individual measuring range.
- **LINEAR mode:** For setting the maximum level (power level setting for outputting the analog output maximum value: typical maximum range value + 3 dBm – typical minimum range value + 3 dBm (in steps of 0.1 dB)) and power range (power range for analog output: 3 to 24 dB (in 3 dB steps)), and outputting voltages of approximately 0 to 2 V or approximately 0 to 5 V (AQ2200-202/212) in proportion to optical power (W) falling within a specified range.
- **LOG mode:** For setting the maximum level (power level setting for outputting the analog output maximum value: typical maximum range value + 3 dBm – typical minimum range value + 3 dBm (in steps of 0.1 dB)) and power range (power range for analog output: 3 to 60 dB (in 1 dB steps)), and outputting voltages of approximately 0 to 2 V or approximately 0 to 5 V (AQ2200-202/212) in proportion to optical power (dB) falling within a specified range.

Examples of Analog Output

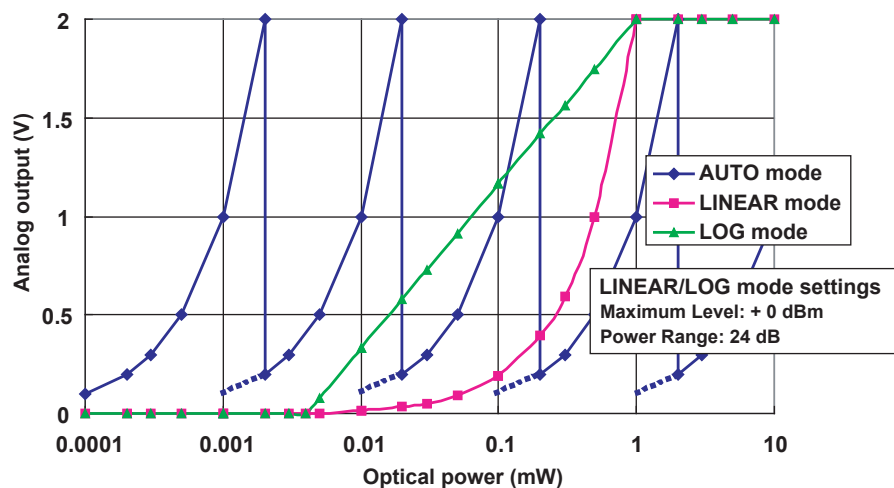

- **Trigger mode:** This can be set only for the AQ2200-202/212. Trigger signals are output from the analog output terminals. These are the same as the signals output from the Trigger Out connector on the rear of the frame controller. For details of the trigger signal, see section 8.2 in the AQ2200 Series Multi-Application Test System User's Manual [Application Operation] (IM 735101-04EN).
  - Avg Time Over: Outputs a trigger signal when measurement is complete.
  - Meas Started: Outputs a trigger signal when a measurement is started.
  - Event Detect: Outputs a trigger signal when an event occurs.

### 3.1 Power Measurement by Optical Sensor Module

#### Holding the Sensor Measurement Value Display

You can stop the measurement data display update. With this function, you can check this measurement data record.

Additionally, even though the display update is stopped, the measurement is continued in the Normal mode.

1. Press **HOLD**.

Hold is shown at the upper right portion of the screen while the display update is being stopped.

To restart the display update, press **HOLD** again.

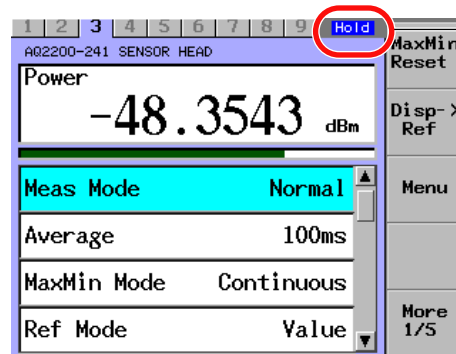

“Hold” is shown while the display update is being stopped.

#### Saving the Displayed Measurement Value

You can save the currently displayed measurement value to a storage device.

1. Press **Save ImmDat** soft key.

File is displayed at the upper right portion of the screen while accessing the storage device.

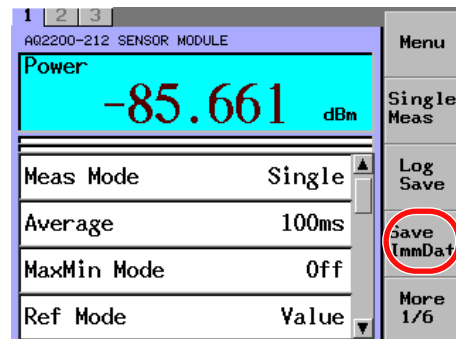

## 4.1 Configuring the DFB-LD Module and LS Module (AQ2200-112)

The operation screens of the DFB-LD module(AQ2200-111) and LS module (AQ2200-112) are used in the explanations below.

If you are using the 2-channel model of the AQ2200-112 module, configure each channel by referring to section 2.2.

- Example of the 2-channel AQ2200-112 model detail screen

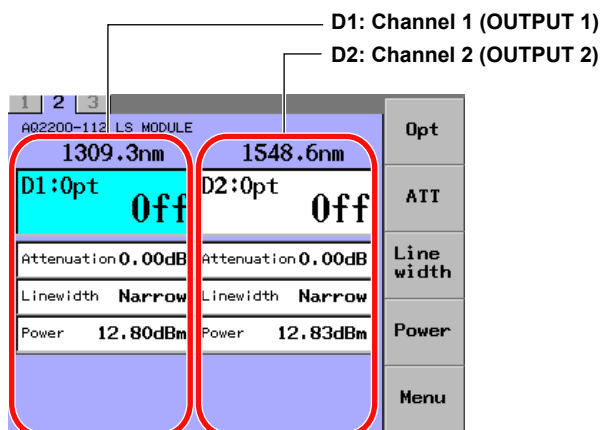

### Soft Key Menu

#### AQ2200-111

Name	Function
Power	Sets the Output power level value
Unit	Selects the Wavelength display unit
Opt	Selects the Optical output on/off setting
WL/Freq	Sets the output wavelength
Att	Sets the attenuating the Laser output
Mod Src	Selects the modulating the Laser output
Mod Freq	Selects the modulation frequency
Linewidth	Selects the Laser line width
WL Offset	Sets the Wavelength offset value
PL Offset	Sets the Output power level value
Menu	Information

#### AQ2200-112

Supported on firmware version (FIRM VER) 3.08 and later.

Name	Function
Opt	Selects the Optical output on/off setting
Att	Sets the attenuating the Laser output
Linewidth	Selects the Laser line width
Power	Display the Output power level value
Menu	Information

### Turning ON/OFF the Optical Output

To turn ON or OFF the optical output, two setting methods are provided. Select a desired setting method corresponding to the application.

Follow the steps below to turn ON or OFF the optical output.

Additionally, as the optical output is turned ON, the LED on the light source panel will be lit.

#### Procedure

#### Setting through the Panel of the Module

- On the AQ2200-111, press **OPT**.
- On the AQ2200-112, press **OUTPUT 1** or **OUTPUT 2**.

The on/off state of the optical output changes.

When the optical output is on, the OPT key or the OUTPUT key lights.

#### Setting through the Panel of the Frame Controller

1. Press **DETAIL** to display the DETAIL screen.
2. Use the **SLOT** keys to select a DFB-LD module or LS module (AQ2200-112) as the current module.
3. Press the **Opt** or **OUTPUT1/OUTPUT2** soft key or move the cursor using the arrow keys to **Opt** and press **ENTER**.

The dialog box will appear.

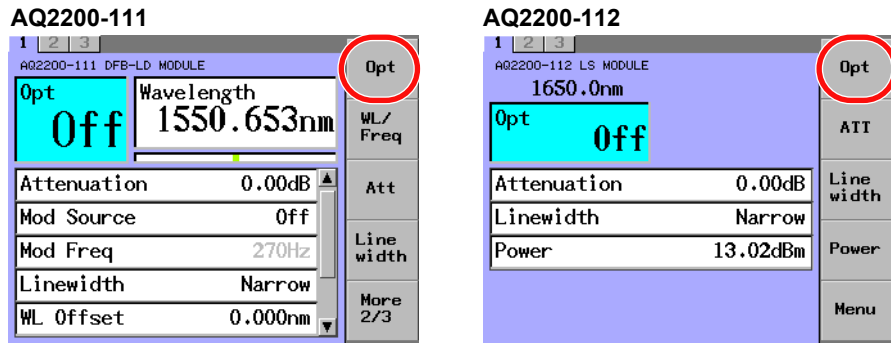

4. Move the cursor using the arrow keys to either of On or Off and press the **OK** soft key or **ENTER**.

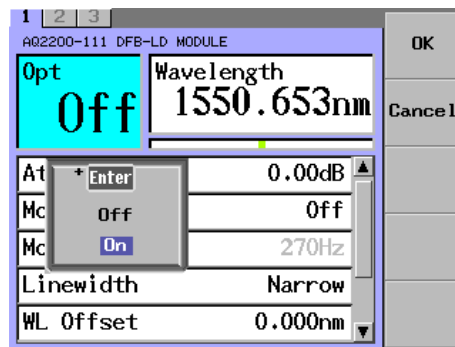

#### Note

When “Lock” is displayed in the “Opt” field, the optical output cannot be generated. One of the followings is the cause:

- Interlock connector is open.
- Laser output is locked.

For details on how to generate the output, see section 2.9 “Unlocking the Laser Output” in [Startup Guide] (IM 735101-01EN).



**WARNING**

Never look at the optical output connector or the top end of the optical fiber connected to the optical output connector while the laser beam is being output. The invisible laser beam cannot be seen. However, if the laser beam enters your eye(s), this may cause eye injury and the eyesight to be ruined excessively.

**French**



**AVERTISSEMENT**

Ne jamais regarder le connecteur de sortie optique ou l'extrémité supérieure de la fibre optique raccordée au connecteur optique pendant la génération du faisceau laser. Le faisceau laser est invisible. S'il atteint l'œil ou les yeux, il peut causer des lésions oculaires et endommager considérablement la vue.

Outputting the Light at the Specified Power

**Procedure**

1. Press **DETAIL** to display the DETAIL screen.
2. Use the **SLOT** keys to select the DFB-LD module or LS module (AQ2200-112) as the current module.
3. Press the **Power** soft key or move the cursor using the arrow keys to Power and press **ENTER**.  
The Power dialog box will appear.
4. Change the numeric value with the numeric keypad or the arrow keys, and press **ENTER**.

At this time, when changing the numeric value with the arrow keys, the set value is set immediately.

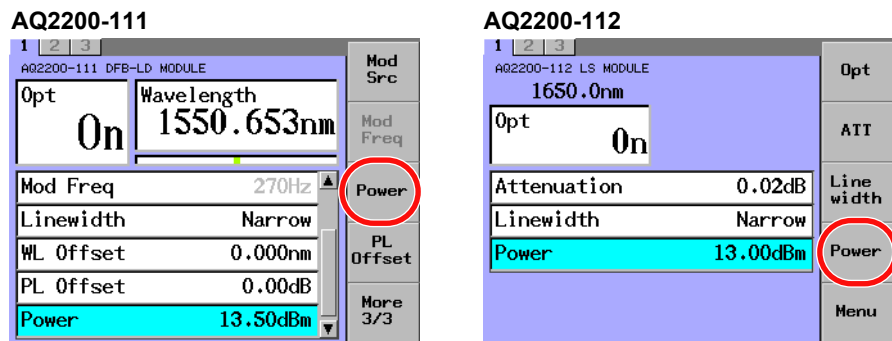

**Note**

Even if the unit of power is W, power settings are in units of dBm.

**Explanation**

On the AQ2200-111 and AQ2200-112, you can specify the power to output. The following shows the relationship among the output power, attenuation amount, and power offset value.

$$PL \text{ (dBm)} = P \text{ default (dBm)} - ATTN(\text{dB})$$

$$P \text{ display (dBm)} = PL \text{ (dBm)} + PL \text{ Offset (dB)}$$

where

PL: Output power (dBm)

P display: Output power display value (dBm)

P default: Maximum output power at shipment (dBm)

ATTN: Attenuation amount (dB) (See Attenuating the Optical Output (next page).)

PL Offset: Power offset value (dB) (See Changing the Offset of the Display Output Power (page 4-6).)

\* The PL offset function is not available on the AQ2200-112. It is always zero.

**Note**

The connector connection status, environment, and/or secular change may affect the P default. Therefore, the values set in Pdisplay are not guaranteed. These values are used as reference.



## Attenuating the Optical Output

The optical output can be attenuated. The attenuation range on the AQ2200-111 is 0 to 10.00 dB, and that on the AQ2200-112 module is 0 to 6.00 dB

### Procedure

1. Press **DETAIL** to display the DETAIL screen.
2. Use the **SLOT** keys to select the DFB-LD module or LS module (AQ2200-112) as the current module.
3. Press the **Att** or **ATT** soft key or move the cursor using the arrow keys to Attenuation and press **ENTER**.  
The Attenuation dialog box will appear.

**AQ2200-111**

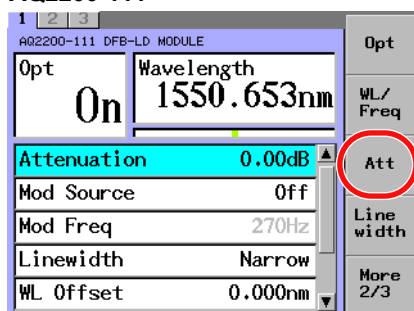

**AQ2200-112**

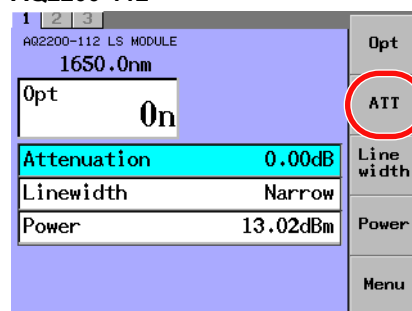

4. Change the numeric value with the numeric keypad or the arrow keys, and press **ENTER**.

At this time, when changing the numeric value with the arrow keys, the set value is set immediately.

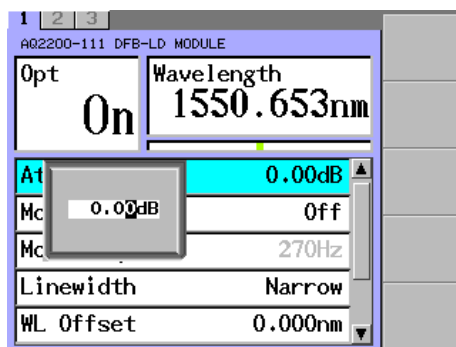

### Note

When you change a value with the arrow keys, the value is updated and reflected in the displayed measured values immediately.

## 4.1 Configuring the DFB-LD Module and LS Module (AQ2200-112)

### Changing the Offset of the Display Output Power (AQ2200-111 only)

You can use a value, that a power offset value (-80.00 to +80.00 dB) is added to the output power, as power display value.

#### Procedure

1. Press **DETAIL** to display the DETAIL screen.
2. Use the **SLOT** keys to select the DFB-LD module as the current module.
3. Press the **PL Offset** soft key or move the cursor using the arrow keys to PL Offset and press **ENTER**.

The PL Offset dialog box will appear.

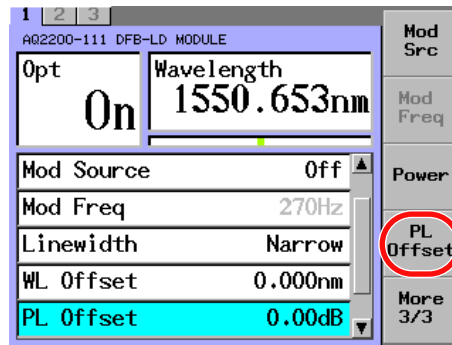

4. Change the numeric value with the numeric keypad or the arrow keys, and press the **OK** soft key or **ENTER**.

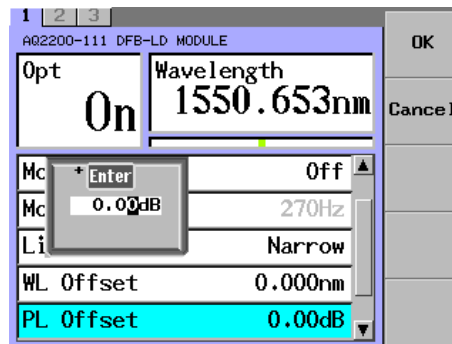

#### Note

Use the power offset to change the displayed output power value. Even if you change the power offset value, the output power will not change.

## Setting the Wavelength (AQ2200-111 only)

This section explains how to change the wavelength of the laser output.

### Procedure

1. Press **DETAIL** to display the DETAIL screen.
2. Use the **SLOT** keys to select the DFB-LD module as the current module.
3. Press the **WL/Freq** soft key or move the cursor using the arrow keys to Wavelength and press **ENTER**.

The Wavelength dialog box will appear.

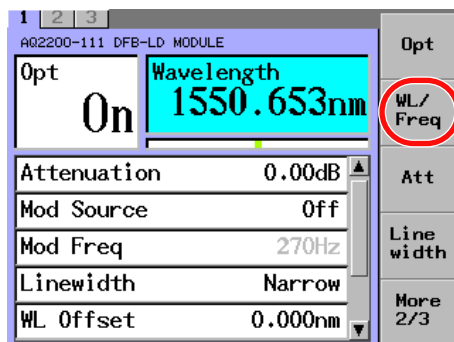

4. Change the numeric value with the numeric keypad or the arrow keys, and press the OK soft key or **ENTER**.

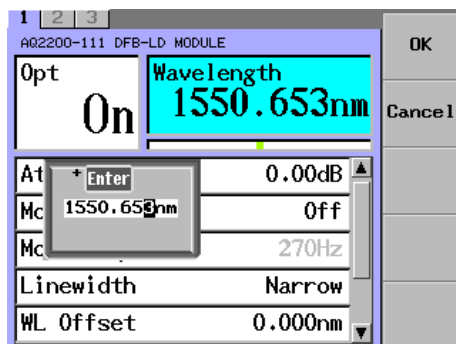

**Explanation**

**Laser Output Wavelength and Displayed Wavelength**

On the AQ2200-111, the laser output wavelength can be varied in the span of about 1.6 nm in 1/1000 nm steps.

The display wavelength has the following relationship.

$$\lambda \text{ display (nm)} = \lambda \text{ output (nm)} + \text{WL Offset (nm)}$$
$$f \text{ (THz)} \times 10^{12} = c / (\lambda \text{ display (nm)} \times 10^{-9})$$

where

$\lambda$  display: Display wavelength (nm)

$\lambda$  output: Output wavelength (nm)

WL Offset: Wavelength offset value (nm)

f: Display frequency (THz)

c: Light velocity in vacuum ( $2.99792458 \times 10^8$  m/s)

**Note**

- For details about WL Offset, see Changing the Wavelength Offset (next page).
- The currently set wavelength position to the allowable wavelength setting range can be checked using the wavelength bar on the DETAIL screen. This data is used as reference of the wavelength setting. The wavelength position shown in the wavelength bar is not affected by the wavelength offset value.



**Changing the Wavelength Offset (AQ2200-111 only)**

You can display a wavelength value that a wavelength offset value (ranging from -10.000 nm to +10.000 nm) is added to the output wavelength.

**Procedure**

1. Press **DETAIL** to display the DETAIL screen.
2. Use the **SLOT** keys to select the DFB-LD module as the current module.
3. Press the **WL Offset** soft key or move the cursor using the arrow keys to WL Offset and press **ENTER**.

The WL Offset dialog box will appear.

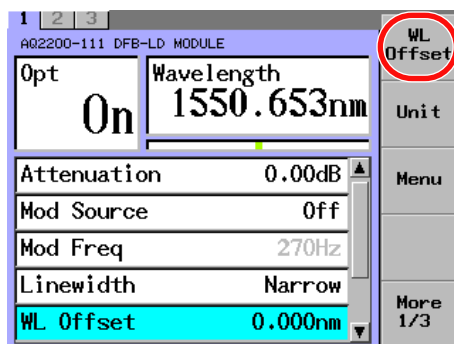

4. Change the numeric value with the numeric keypad or the arrow keys, and press the **OK** soft key or **ENTER**. Even if the unit of wavelength is THz, the wavelength offset is set in units of nm.

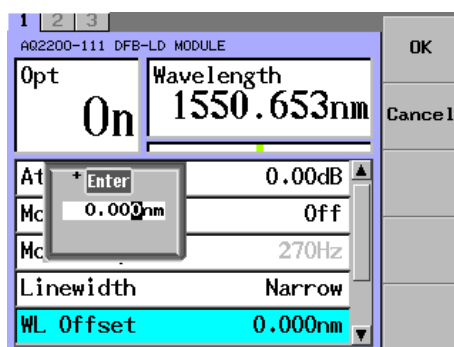
**Note**

Use the wavelength offset to change the displayed laser output wavelength value. Even if you change the wavelength offset value, the laser output wavelength will not change.

### Modulating the Laser Output (AQ2200-111 only)

Two kinds of modulation mode settings are provided. Select a desired setting corresponding to the application.

#### Procedure

##### Setting through the Panel of the Module

1. Press **CW/CHOP** on the panel to switch between CW and CHOP every time. When changing to the CHOP modulation, the LED is lit and Internal is shown in Mod Source on the screen.

##### Setting through the Panel of the Frame Controller

1. Press **DETAIL** to display the DETAIL screen.
2. Use the **SLOT** keys to select the DFB-LD module as the current module.
3. Press the **Mod Src** soft key or move the cursor using the arrow keys to Mod Source and press **ENTER**.

The Mod Source dialog box will appear.

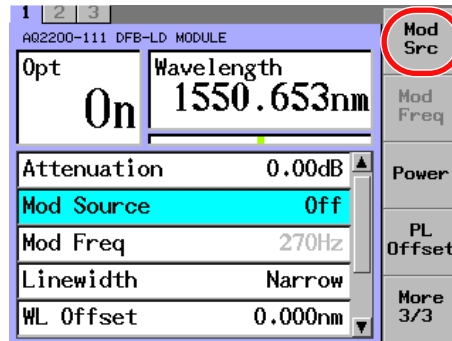

4. Move the cursor using the arrow keys to OFF (for CW) or Internal (for CHOP) and press **ENTER**.

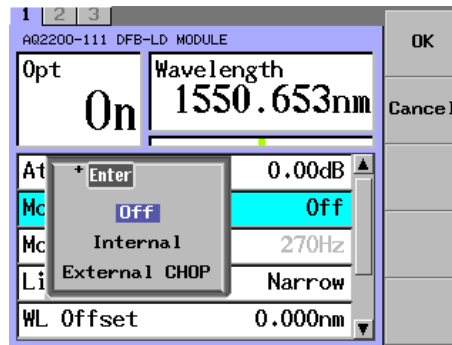

#### Note

- The absolute value power display shows the power level of the peak value in the CHOP modulation.
- You can select External CHOP on models with the -MODC suffix code.
- You can select External SINE on models with the -MODS suffix code.
- External CHOP and External SINE do not appear on models with the -MODN suffix code.

#### Explanation

##### Modulation

You can perform the CW or CHOP (DUTY 50%) modulation of the optical output.

CHOP (DUTY 50%) is when the Mod Src setting is Internal. For External Chop, the duty value depends on the external signal.

For CHOP modulation, 270 Hz, 1 kHz, 2 kHz, or desired frequency (0.1 to 300.0 kHz) can be set. For details on setting the modulation frequency, see "Changing the Modulation Frequency" (next page).

## Changing the Modulation Frequency (AQ2200-111 only)

### Procedure

1. Press **DETAIL** to display the DETAIL screen.
2. Use the **SLOT** keys to select the DFB-LD module as the current module.
3. Press the **Mod Freq** soft key or move the cursor using the arrow keys to Mod Freq and press **ENTER**.

The Mod Freq dialog box will appear.

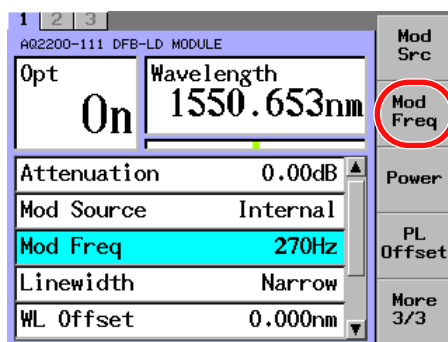

4. Press **ENTER**. A dialog box for selecting the modulation appears.

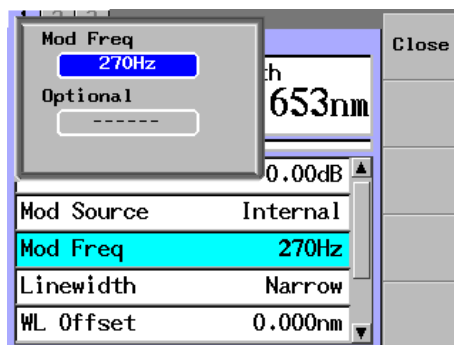

5. Move the cursor using the arrow keys to a desired frequency and press the **OK** soft key or **ENTER**.

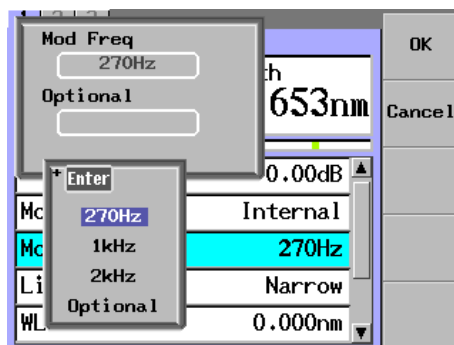

**Selecting a Specific Frequency (0.1 to 300.0 kHz)**

6. Move the cursor using the arrow keys to Optional, and press the **OK** soft key or **ENTER**.

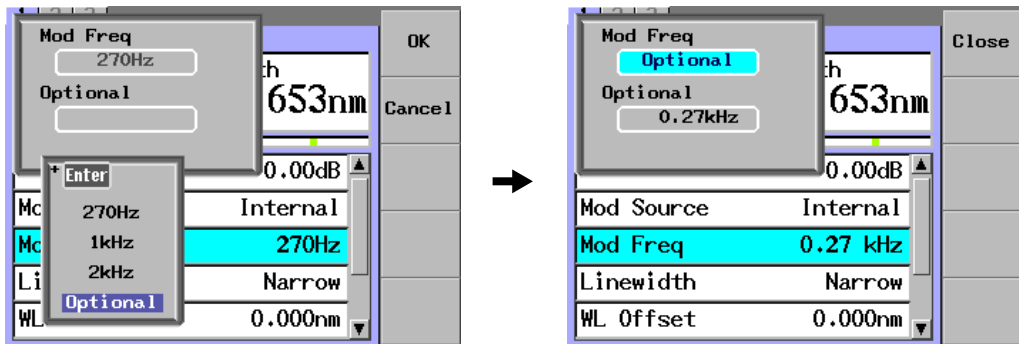

7. Move the cursor using the arrow keys to Optional.

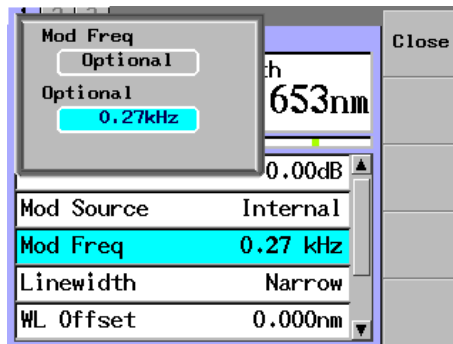

8. Press **ENTER**.  
A frequency specification dialog box appears.
9. Use the numeric keypad or the arrow keys to change the value, and press the **OK** soft key or **ENTER**.

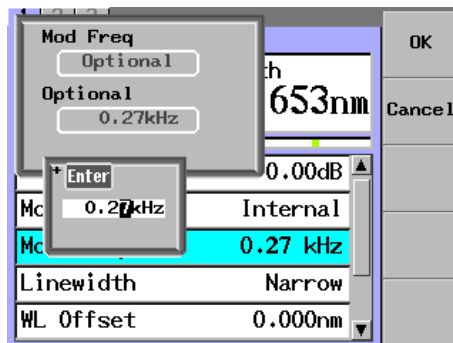

**Note**

If Mod Source has been set to Internal, you can set the modulation frequency.



## Changing the Laser Line Width

You can select a desired laser line width from two kinds of selections, "Narrow" and "Wide". To minimize the effects of reflection-induced interference, you can stabilize power measurements by selecting a laser line width of "Wide."

### Procedure

1. Press **DETAIL** to display the DETAIL screen.
2. Use the **SLOT** keys to select the DFB-LD module or LS module (AQ2200-112) as the current module.
3. Press the **Linewidth** soft key or move the cursor using the arrow keys to Linewidth and press **ENTER**.  
The Linewidth dialog box will appear.

AQ2200-111

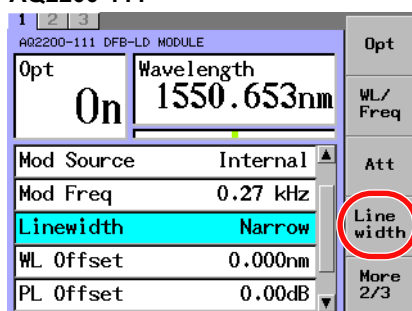

AQ2200-112

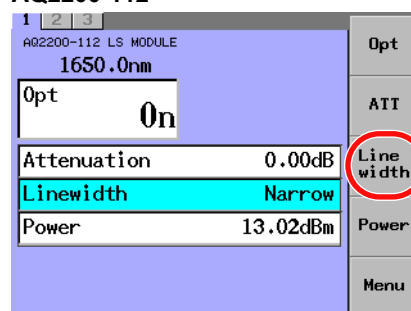

4. Move the cursor using the arrow keys to the line width more suitable for the purpose and press **ENTER**.

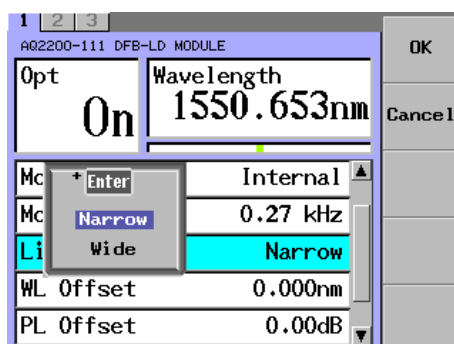

### Switching the Displayed Units (AQ2200-111 only)

You can switch the units that are used to display the power (dBm or W) and wavelength (nm or THz).

#### Procedure

1. Press **DETAIL** to display the DETAIL screen.
2. Use the **SLOT** keys to select the DFB-LD module as the current module.
3. Press the **Unit** soft key.  
The Unit dialog box will appear.

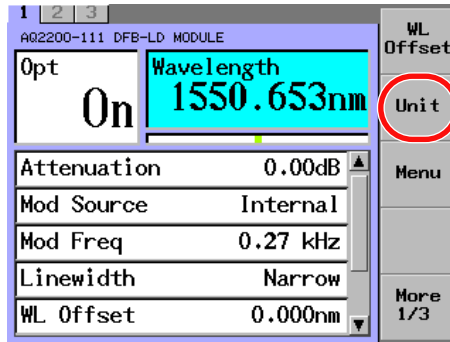

### Changing the Power Display Unit

4. Move the cursor using the arrow keys to Power Unit and press **ENTER**.  
The dialog box for switching the displayed units will appear.

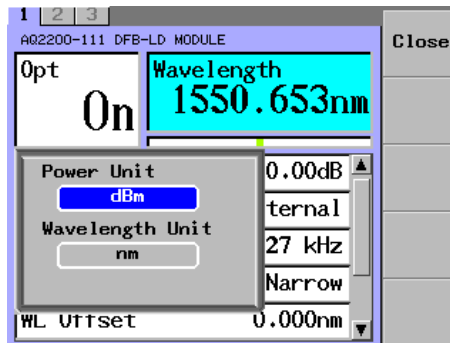

5. Move the cursor using the arrow keys to either of dBm or W and press **ENTER**.

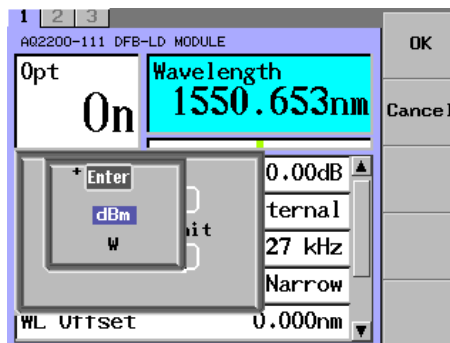

### Changing the Wavelength Display Unit

4. Move the cursor using the arrow keys to Wavelength Unit and press **ENTER**.  
The dialog box for switching the displayed units will appear.

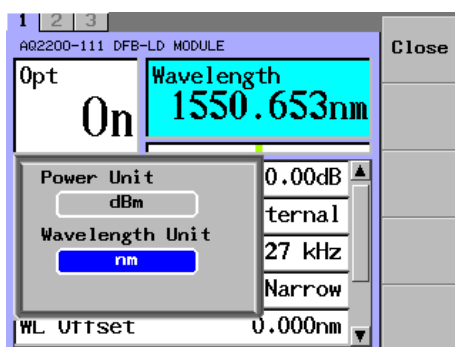

5. Move the cursor using the arrow keys to either of nm (wavelength display) or THz (frequency display) and press **ENTER**.

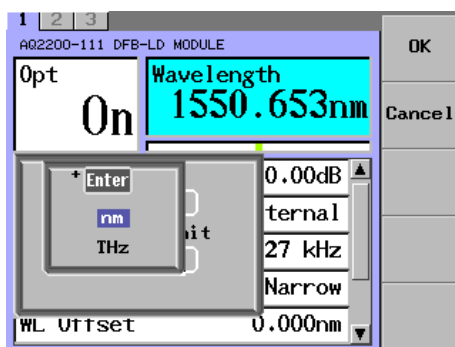

### Explanation

#### Power Display Unit

You can switch the power display unit between the dBm display and W display.  
The following calculation formula shows the relationship between the dBm and W.

$$P_{dBm} = 10 \log P_w$$

P<sub>w</sub>: Optical power (mW)  
P<sub>dBm</sub>: Optical power (dBm)

#### Wavelength Display Unit

You can switch the display unit between the wavelength display and frequency display.  
The following calculation formula shows the relationship between the wavelength and frequency.

$$f \text{ (THz)} \times 10^{12} = c / (\lambda \text{ display (nm)} \times 10^{-9})$$

where

- $\lambda$  display: Display wavelength (nm)  
f: Display frequency (THz)  
c: Light velocity in vacuum ( $2.99792458 \times 10^8$  m/s)

## 4.2 Configuring the FP-LD Module

### Soft Key Menu

Name	Function
Power	Sets the Output power level value
PL Offset	Sets the Output power offset value
Unit	Selects the Wavelength display unit
Opt	Selects the Laser output on/off setting
Att	Sets the attenuating the Laser output
Mod Src	Selects the modulating the Laser output
Mod Freq	Selects the modulation frequency
Menu	Information

### Turning ON/OFF the Laser Output

To turn ON or OFF the laser output, two setting methods are provided. Select a desired setting method corresponding to the application.

Follow the steps below to turn ON or OFF the laser output.

Additionally, as the laser output is turned ON, the LED on the module panel will be lit.

### Procedure

#### Setting through the Panel of the Module

1. Press the **OPT** key on the panel to switch the light source between ON and OFF.

#### Setting through the Panel of the Frame Controller

1. Press **DETAIL** to display the DETAIL screen.
2. Use the **SLOT** keys to select an FP-LD module as the current module.
3. Press the **Opt** soft key or move the cursor using the arrow keys to Opt and press **ENTER**.

The Opt dialog box will appear.

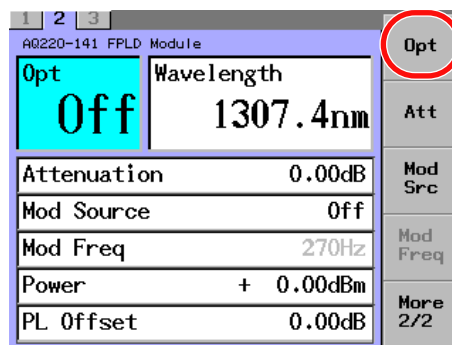

4. Move the cursor using the arrow keys to either of On or Off and press the **OK** soft key or **ENTER**.

1	2	3
A0220-141 FPLD Module		
Opt	Off	Wavelength 1307.4nm
At	+ Enter	0.00dB
Mc	Off	Off
Mc	On	270Hz
Power	+ 0.00dBm	
PL Offset	0.00dB	

### Note

When "Lock" is displayed in the "Opt" field, the optical output cannot be generated. One of the followings is the cause:

- Interlock connector is open.
- Laser output is locked.

For details on how to generate the output, see section 2.9 "Unlocking the Laser Output" in [Startup Guide] (IM 735101-01EN).



### WARNING

Never look at the optical output connector or the top end of the optical fiber connected to the optical output connector while the laser beam is being output. The invisible laser beam cannot be seen. However, if the laser beam enters your eye(s), this may cause eye injury and the eyesight to be ruined excessively.

French



### AVERTISSEMENT

Ne jamais regarder le connecteur de sortie optique ou l'extrémité supérieure de la fibre optique raccordée au connecteur optique pendant la génération du faisceau laser. Le faisceau laser est invisible. S'il atteint l'œil ou les yeux, il peut causer des lésions oculaires et endommager considérablement la vue.

Outputting the Laser Beam with the Set Power

**Procedure**

1. Press **DETAIL** to display the DETAIL screen.
2. Use the **SLOT** keys to select an FP-LD module as the current module.
3. Press the **Power** soft key or move the cursor using the arrow keys to Power and press **ENTER**.

The Power dialog box will appear.

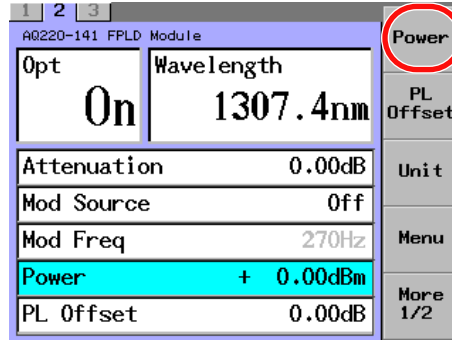

4. Change the numeric value with the numeric keypad or the arrow keys, and press the OK soft key or **ENTER**.

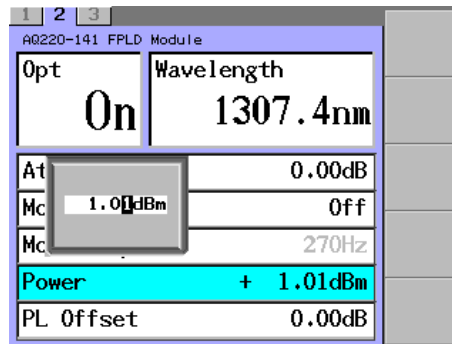

**Note**

Even if the unit of power is W, power settings are in units of dBm.

**Explanation**

With the AQ2200-141, you can output the laser beam by specifying an absolute power value.

The following shows the relationship among the laser beam output power, attenuation amount, and power offset value.

$$PL \text{ (dBm)} = P \text{ default (dBm)} - ATTN(\text{dB})$$

$$P \text{ display (dBm)} = PL \text{ (dBm)} + PL \text{ Offset (dB)}$$

where

- PL: Laser output power (dBm)
- P display: Output power display value (dBm)
- P default: Maximum output power at shipment (dBm)
- ATTN: Attenuation amount (dB) (See Attenuating the Laser Output (next page).)
- PL Offset: Power offset value (dB) (See Changing the Offset of the Display Output Power (page 4-20).)

**Note**

The environment and/or secular change may affect the Pdefault. Therefore, the values set in PL are not guaranteed. These values are used as reference.

### Attenuating the Laser Output

You can attenuate the laser output (0 to 6.00 dB).

#### Procedure

1. Press **DETAIL** to display the DETAIL screen.
2. Use the **SLOT** keys to select an FP-LD module as the current module.
3. Press the **Att** soft key or move the cursor using the arrow keys to Attenuation and press **ENTER**.

The Attenuation dialog box will appear.

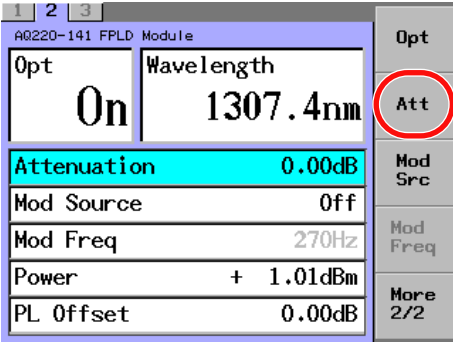

4. Change the numeric value with the numeric keypad or the arrow keys, and press **ENTER**.

At this time, when changing the numeric value with the arrow keys, the set value is set immediately.

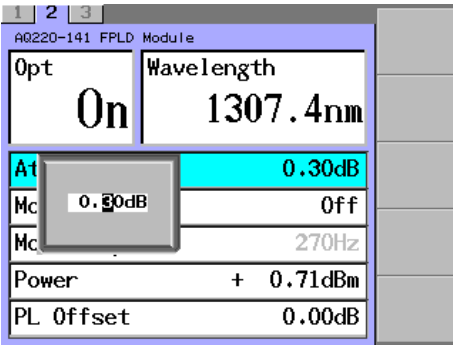

### Changing the Offset of the Display Output Power

You can use a value, that a power offset value (-80.00 to +80.00 dB) is added to the output power, as power display value.

#### Procedure

1. Press **DETAIL** to display the DETAIL screen.
2. Use the **SLOT** keys to select an FP-LD module as the current module.
3. Press the **PL Offset** soft key or move the cursor using the arrow keys to PL Offset and press **ENTER**.

The PL Offset dialog box will appear.

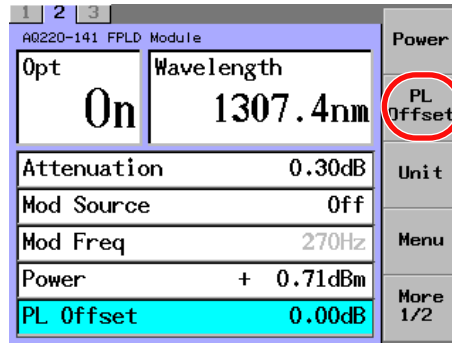

4. Change the numeric value with the numeric keypad or the arrow keys, and press the **OK** soft key or **ENTER**.

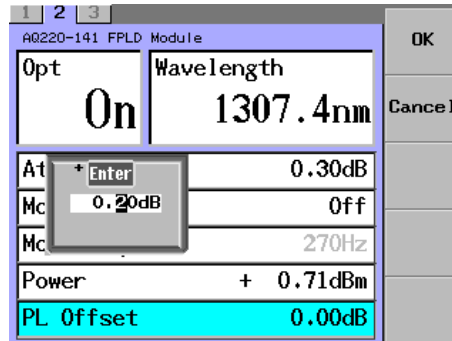

#### Note

Use the power offset to change the displayed laser output power value. Even if you change the power offset value, the laser output power will not change.



## Modulating the Laser Output

Two kinds of modulation mode settings are provided. Select a desired setting corresponding to the application.

### Procedure

#### Setting through the Panel of the Module

1. Press the **CW/CHOP** key on the panel to switch between CW and CHOP. When changing to the CHOP modulation, the LED is lit and "Internal" is shown in "Mod Source" on the screen.

#### Setting through the Panel of the Frame Controller

1. Press **DETAIL** to display the DETAIL screen.
2. Use the **SLOT** keys to select an FP-LD module as the current module.
3. Press the **Mod Src** soft key or move the cursor using the arrow keys to Mod Source and press **ENTER**.

The Mod Source dialog box will appear.

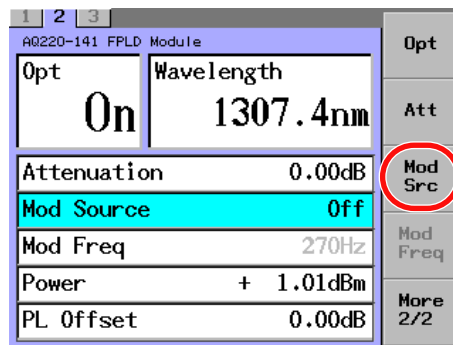

4. Move the cursor using the arrow keys to OFF (for CW) or Internal (for CHOP) and press **ENTER**.

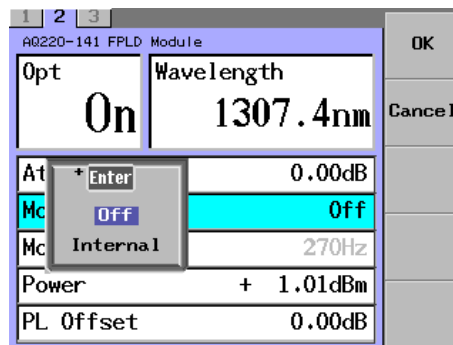

#### Note

The absolute value power display shows the power level of the peak value in the CHOP modulation.

### Explanation

#### Modulation

You can perform the CW or CHOP (DUTY 50%) modulation of the optical output.

For CHOP modulation, 270 Hz, 1 kHz, or 2 kHz can be set.

For details on setting the modulation frequency, see "Changing the Modulation Frequency" (next page).

### Changing the Modulation Frequency

#### Procedure

1. Press **DETAIL** to display the DETAIL screen.
2. Use the **SLOT** keys to select an FP-LD module as the current module.
3. Press the **Mod Freq** soft key or move the cursor using the arrow keys to Mod Freq and press **ENTER**.

A dialog box for selecting the modulation appears.

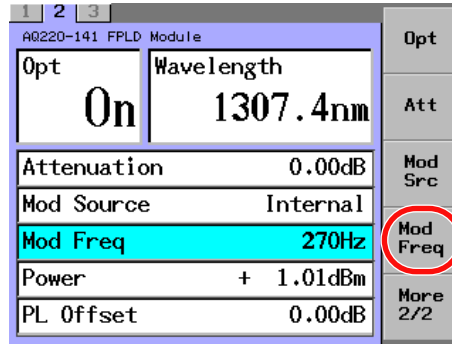

4. Press **ENTER**.  
A dialog box for selecting the modulation frequency appears.
5. Move the cursor using the arrow keys to a desired frequency and press the **OK** soft key or **ENTER**.

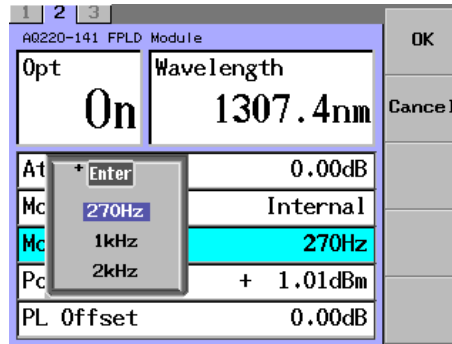

**Note**

If Mod Source has been set to Internal, you can set the modulation frequency.

### Switching the Displayed Units

You can switch the units that are used to display the power (dBm or W) and wavelength (nm or THz).

#### Procedure

1. Press **DETAIL** to display the DETAIL screen.
2. Use the **SLOT** keys to select an FP-LD module as the current module.
3. Press the **Unit** soft key.  
The Unit dialog box will appear.

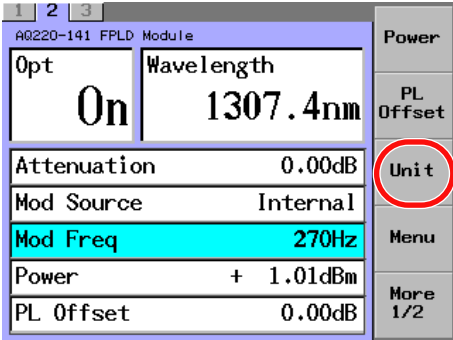

### Changing the Power Display Unit

4. Move the cursor using the arrow keys to Power Unit and press **ENTER**.  
The dialog box for switching the displayed units will appear.

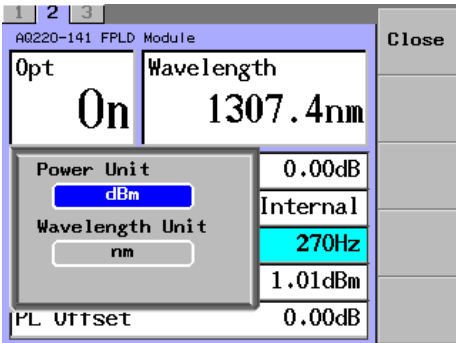

5. Move the cursor using the arrow keys to either of dBm or W and press **ENTER**.

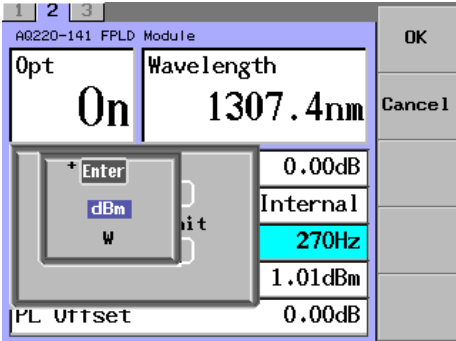

**Changing the Wavelength Display Unit**

4. Move the cursor using the arrow keys to Wavelength Unit and press **ENTER**. The dialog box for switching the displayed units will appear.

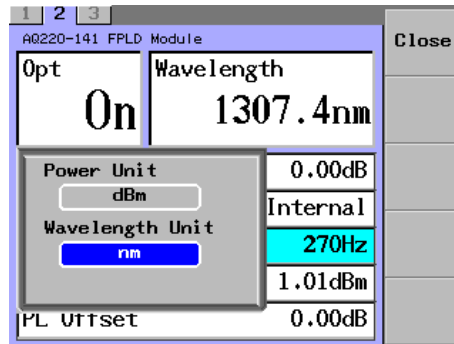

5. Move the cursor using the arrow keys to either of nm (wavelength display) or THz (frequency display) and press **ENTER**.

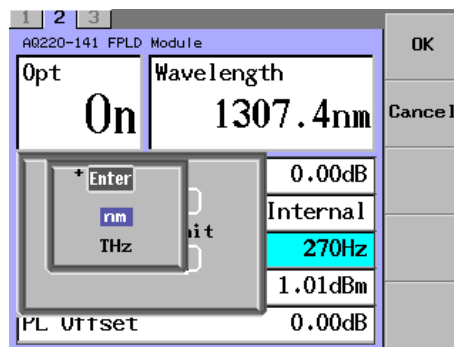

**Explanation**

**Power Display Unit**

You can switch the power display unit between the dBm display and W display. The following calculation formula shows the relationship between the dBm and W.

$$Pd_{Bm} = 10 \log P_w$$

P<sub>w</sub>: Optical power (mW)  
 P<sub>dBm</sub>: Optical power (dBm)

**Wavelength Display Unit**

You can switch the display unit between the wavelength display and frequency display. The following calculation formula shows the relationship between the wavelength and frequency.

$$f \text{ (THz)} \times 10^{12} = c / (\lambda \text{ display (nm)} \times 10^{-9})$$

where

- λ display: Display wavelength (nm)
- f: Display frequency (THz)
- c: Light velocity in vacuum (2.99792458 x 10<sup>8</sup> m/s)

## 4.3 Configuring the DUAL FP-LD Module

FP-LD light sources with wavelengths of 1310 nm and 1550 nm are built-into the AQ2200-142. Therefore, 1310 nm- or 1550 nm-laser can be output individually or laser having both 1310 nm and 1550 nm wavelengths can also be output. Additionally, in this module, Opt1/Opt2, WL1/WL2, ATT1/ATT2, Power1/Power2, and PL Offset1/PL Offset2, etc. mean the laser light source1/laser light source 2. The laser light source1 shows the FP-LD light source with a wavelength of 1310 nm while the laser light source2 shows the FP-LD light source with a wavelength of 1550 nm.

### Soft Key Menu

Name	Function
Power	Sets the Output power level value
PL Offset	Sets the Output power offset value
Unit	Selects the Wavelength display unit
Opt	Selects the Laser output on/off setting
Att	Sets the attenuating the Laser output
Mod Src	Selects the modulating the Laser output
Mod Freq	Selects the modulation frequency
Menu	Information

### Turning ON/OFF the Laser Output

To turn ON or OFF the laser output, two setting methods are provided. Select a desired setting method corresponding to the application. Follow the steps below to turn ON or OFF the laser output. Additionally, as the laser output is turned ON, the LED on the module panel will be lit.

### Procedure

#### Setting through the Panel of the Module

1. Press the **OPT** key on the panel to change in order, like OFF -> 1310 nm laser ON -> 1550 nm laser ON -> 1310 nm/1550 nm laser ON.

#### Setting through the Panel of the Frame Controller

1. Press **DETAIL** to display the DETAIL screen.
2. Use the **SLOT** keys to select a DUAL FP-LD module as the current module.
3. Use the arrow keys to move the cursor to Opt1 or Opt2.

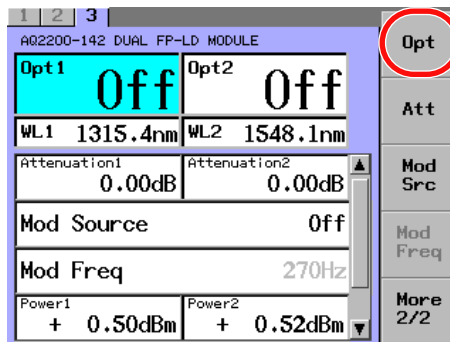

4. Press the **Opt** soft key or ENTER. An on/off selection dialog box will appear

### 4.3 Configuring the DUAL FP-LD Module

5. Use the arrow keys to move the cursor to On or Off, and press the **OK** soft key or **ENTER**.

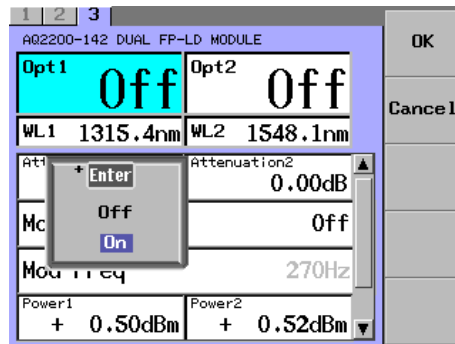

#### Turning Both Laser Light Sources On

After turning one laser light source on, turn the other laser light source on.

6. After step 5, return to step 3 to select the other laser light source, and repeat steps 4 and 5.

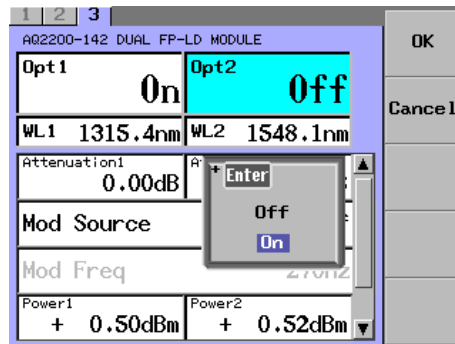

#### Note

When “Lock” is displayed in the “Opt” field, the optical output cannot be generated. One of the followings is the cause:

- Interlock connector is open.
- Laser output is locked.

For details on how to generate the output, see section 2.9 “Unlocking the Laser Output” in [Startup Guide] (IM 735101-01EN).



#### WARNING

Never look at the optical output connector or the top end of the optical fiber connected to the optical output connector while the laser beam is being output. The invisible laser beam cannot be seen. However, if the laser beam enters your eye(s), this may cause eye injury and the eyesight to be ruined excessively.

#### French



#### AVERTISSEMENT

Ne jamais regarder le connecteur de sortie optique ou l'extrémité supérieure de la fibre optique raccordée au connecteur optique pendant la génération du faisceau laser. Le faisceau laser est invisible. S'il atteint l'œil ou les yeux, il peut causer des lésions oculaires et endommager considérablement la vue.

## Outputting the Laser Beam with the Set Power

### Procedure

1. Press **DETAIL** to display the DETAIL screen.
2. Use the **SLOT** keys to select the DUAL FP-LD module as the current module.
3. Use the arrow keys to move the cursor to Power1 or Power2.

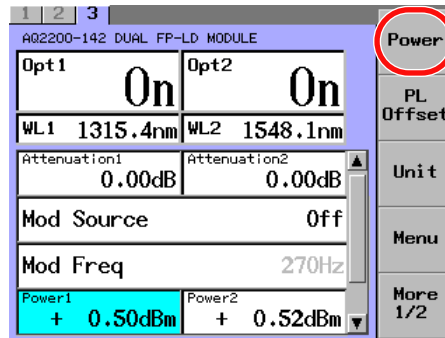

4. Press the **Power** soft key or **ENTER**. The Power dialog box (for inputting a numeric value) will appear.
5. Change the numeric value with the numeric keypad or the arrow keys, and press **ENTER**.

At this time, when changing the numeric value with the arrow keys, the set value is set immediately.

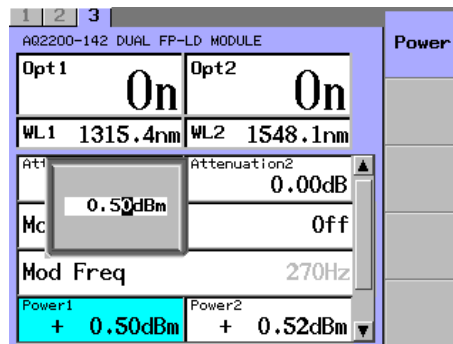

### Note

Even if the unit of power is W, power settings are in units of dBm.

### 4.3 Configuring the DUAL FP-LD Module

---

#### Explanation

With the AQ2200-142, you can output the laser beam by specifying an absolute power value, Power1 (1310 nm) or Power2 (1550 nm).

The following shows the relationship among the laser beam output power, attenuation amount, and power offset value.

$$PL \text{ (dBm)} = P \text{ default (dBm)} - \text{ATTN(dB)}$$

$$P \text{ display (dBm)} = PL \text{ (dBm)} + PL \text{ Offset (dB)}$$

where

PL: Laser output power (dBm)

P display: Output power display value (dBm)

P default: Maximum output power at shipment (dBm)

ATTN: Attenuation amount (dB) (See Attenuating the Laser Output (next page).)

PL Offset: Power offset value (dB) (See Changing the Offset of the Display Output Power (page 4-29).)

#### Note

---

P default is subject to changes in the environment and the passage of time. Therefore, the value set by Pdisplay is not guaranteed but is instead only a guide.

---



## Attenuating the Optical Output

In the AQ2200-142, the laser output with each wavelength (Power1 (1310 nm), Power2 (1550 nm)) can be attenuated with a desired value (0 to 6.00 dB).

### Procedure

1. Press **DETAIL** to display the DETAIL screen.
2. Use the **SLOT** keys to select the DUAL FP-LD module as the current module.
3. Use the arrow keys to move the cursor to Attenuation1 or Attenuation2.

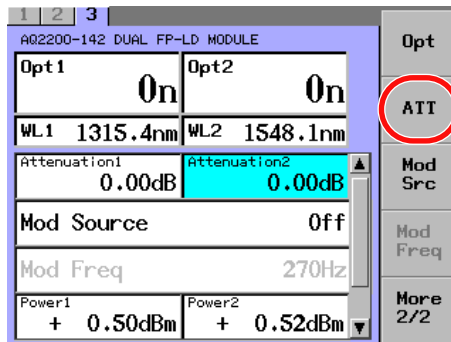

4. Press the **Att** soft key or **ENTER**. The Attenuation dialog box (for inputting a numeric value) will appear.
5. Change the numeric value with the numeric keypad or the arrow keys, and press **ENTER**.

At this time, when changing the numeric value with the arrow keys, the set value is set immediately.

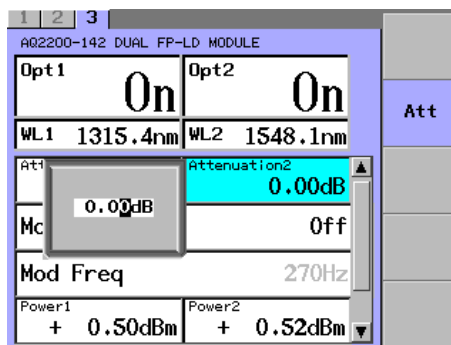

### Note

When you change a value with the arrow keys, the value is updated and reflected in the displayed measured values immediately.

### 4.3 Configuring the DUAL FP-LD Module

#### Changing the Offset of the Display Output Power

By setting a desired value (-80.00 to +80.00 dB) to the optical power offset values (PL Offset1, PL Offset2), a value, that a power offset value is added to the laser output power with each wavelength, is used as power display value.

#### Procedure

1. Press **DETAIL** to display the DETAIL screen.
2. Use the **SLOT** keys to select the DUAL FP-LD module as the current module.
3. Use the arrow keys to move the cursor to PL Offset1 or PL Offset2.

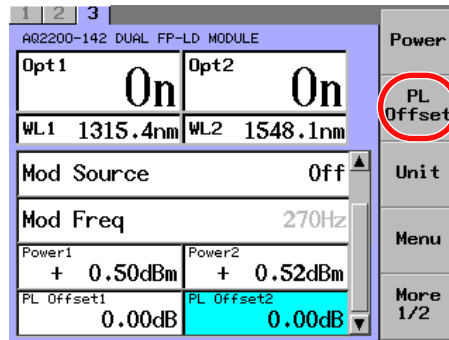

4. Press **PL Offset** soft key or **ENTER**.  
The PL Offset dialog box will appear.
5. Change the numeric value with the numeric keypad or the arrow keys, and press the OK soft key or **ENTER**.

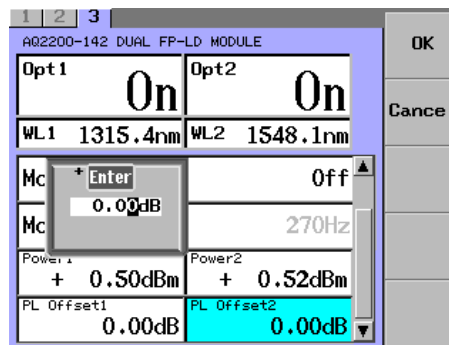

#### Note

Use the power offset to change the displayed laser output power value. Even if you change the power offset value, the laser output power will not change.

## Modulating the Optical Output

Two kinds of modulation setting methods are provided. Select a desired method corresponding to the application.

### Procedure

#### Setting through the Panel of the Module

1. Press **CW/CHOP** on the panel to switch between CW and CHOP every time. When changing to the CHOP modulation, the LED is lit and Internal is shown in Mod Source on the screen.

#### Setting through the Panel of the Frame Controller

1. Press **DETAIL** to display the DETAIL screen.
2. Use the **SLOT** keys to select the DUAL FP-LD module as the current module.
3. Press the **Mod Src** soft key or move the cursor using the arrow keys to Mod Source and press **ENTER**.

The Mod Source dialog box will appear.

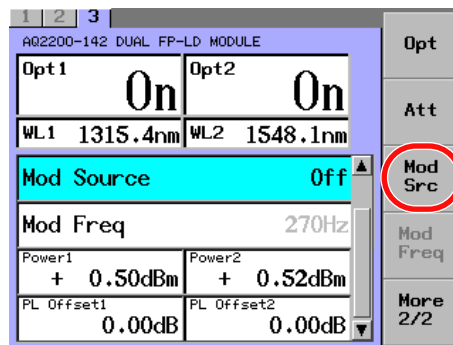

4. Move the cursor using the arrow keys to OFF (for CW) or Internal (for CHOP) and press **ENTER**.

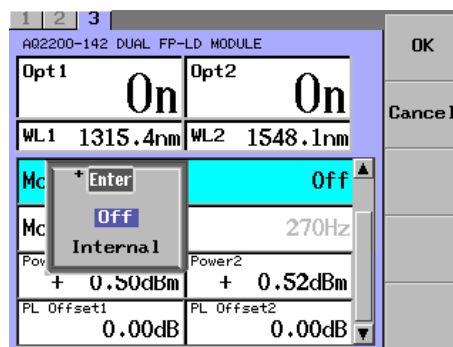

### Note

The absolute value power display shows the power level of the peak value in the CHOP modulation.

### Explanation

#### Modulation

You can perform the CW or CHOP (DUTY 50%) modulation of the optical output.

For CHOP modulation, 270 Hz, 1 kHz, 2 kHz, or desired frequency (0.1 to 300.0 kHz) can be set.

For details on setting the modulation frequency, see “Changing the Modulation Frequency” (next page).

### Changing the Modulation Frequency

#### Procedure

1. Press **DETAIL** to display the DETAIL screen.
2. Use the **SLOT** keys to select the DUAL FP-LD module as the current module.
3. Press the **Mod Freq** soft key or move the cursor using the arrow keys to "Mod Freq" and press **ENTER**.

A dialog box for selecting the modulation appears.

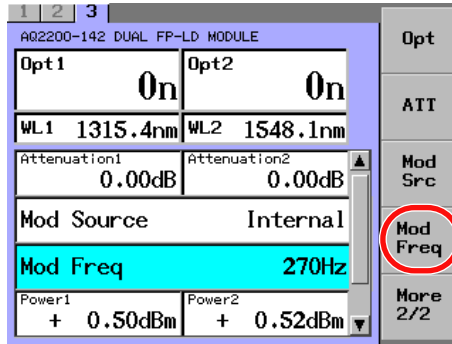

4. Move the cursor using the arrow keys to a desired frequency and press the **OK** soft key or **ENTER**.

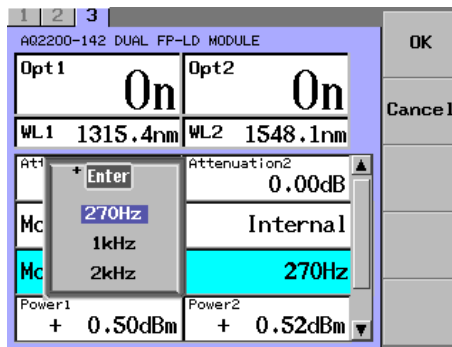

#### Note

If Mod Source has been set to Internal, you can set the modulation frequency.

## Switching the Displayed Units

You can switch the units that are used to display the power (dBm or W) and wavelength (nm or THz).

### Procedure

1. Press **DETAIL** to display the DETAIL screen.
2. Use the **SLOT** keys to select the DUAL FP-LD module as the current module.
3. Press the **Unit** soft key.  
The Unit dialog box will appear.

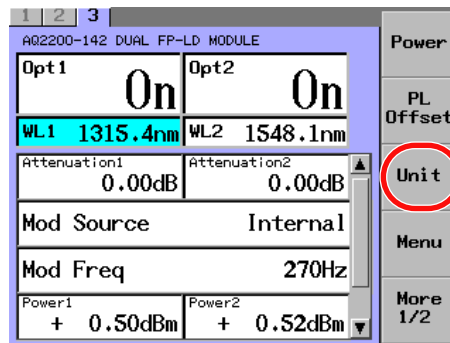

### Changing the Power Display Unit

4. Move the cursor using the arrow keys to Power Unit and press **ENTER**.  
The dialog box for switching the displayed units will appear.

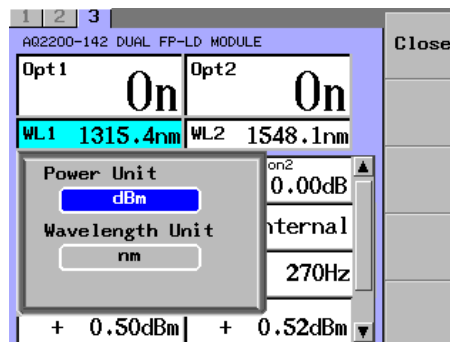

5. Move the cursor using the arrow keys to either of dBm or W and press **ENTER**.

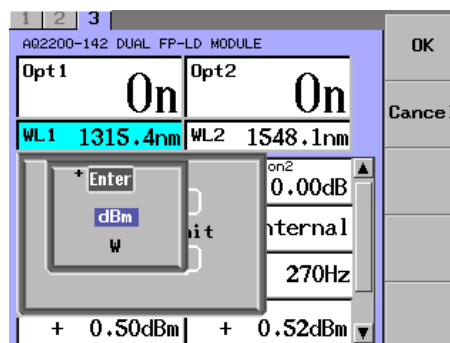

### 4.3 Configuring the DUAL FP-LD Module

#### Changing the Wavelength Display Unit

4. Move the cursor using the arrow keys to Wavelength Unit and press **ENTER**. The dialog box for switching the displayed units will appear.

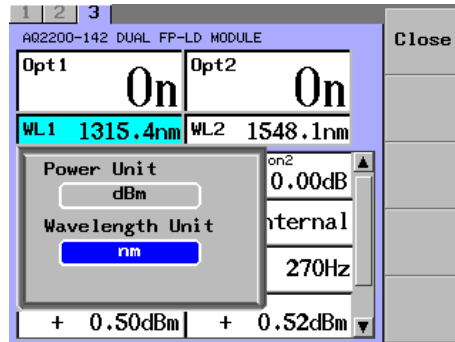

5. Move the cursor using the arrow keys to either of nm (wavelength display) or THz (frequency display) and press **ENTER**.

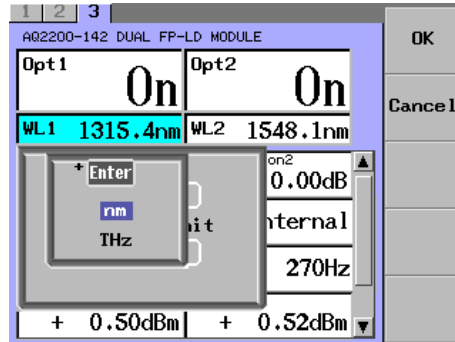

#### Explanation

##### Power Display Unit

You can switch the power display unit between the dBm display and W display. The following calculation formula shows the relationship between the dBm and W.

$$Pd\text{Bm} = 10 \log P\text{w}$$

Pw: Optical power (mW)

PdBm: Optical power (dBm)

##### Wavelength Display Unit

You can switch the display unit between the wavelength display and frequency display. The following calculation formula shows the relationship between the wavelength and frequency.

$$f \text{ (THz)} \times 10^{12} = c / (\lambda \text{ display (nm)} \times 10^{-9})$$

where

$\lambda$  display: Display wavelength (nm)

f: Display frequency (THz)

c: Light velocity in vacuum ( $2.99792458 \times 10^8$  m/s)

## 5.1 Sets the Tunable Laser Source (TLS Module)

### Soft Key Menu

Name	Functional
Opt	Turns ON or OFF the optical output.
WL/FREQ	Sets the wavelength value.
Power	Sets the power value.
WL Cal	Calibrates the wavelength.
Sweep Start	Starts the sweep.
Sweep Stop	Stops the sweep.
Sweep Cond	Sets various sweep conditions.
Sweep Mode	Sets the sweep method (manual, step, continuous).
Linewidth	Sets the line width of the optical output.
$\Delta f$	Sets the frequency to the reference wavelength.
WL -> WL0	Registers the current wavelength as reference wavelength.
Trig	Sets trigger conditions.
OSA Sync	Sets the synchronous sweep with the optical spectrum analyzer.
Unit	Changes the display unit.
Menu	Shows the information.

### Turning ON/OFF the Laser Output

The laser output ON/OFF operation can be performed with the push-button switch on the module panel or through the frame controller. Since the default setting is OFF, you must turn ON the laser output before using the laser output. This section describes how to turn ON/OFF the laser output.

## 5.1 Sets the Tunable Laser Source (TLS Module)

### Procedure

#### Making Settings from the Light Source Module

1. Press **OPT** on the light source module to switch between ON and OFF.  
The LED above the OPT key lights when the laser is on and turns off when the laser is off.

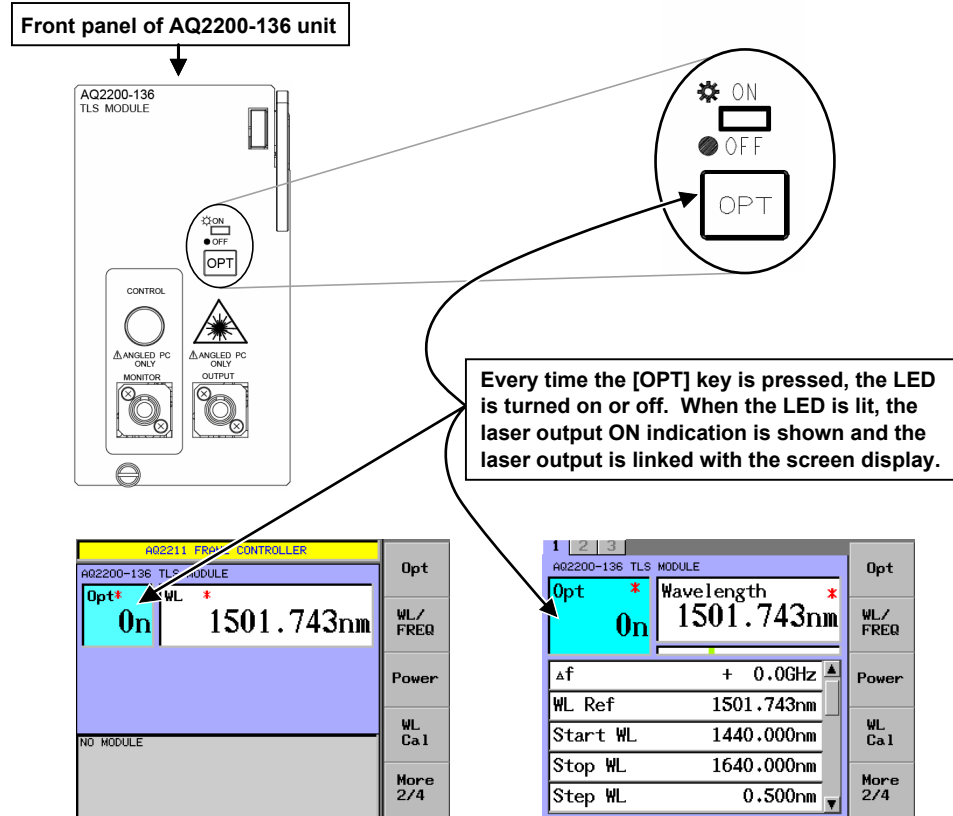



## Making Settings from the Frame Controller Panel

1. Press the **Opt** soft key or move the cursor using the arrow keys to Opt, and then press **ENTER**.

The Opt dialog box will appear.

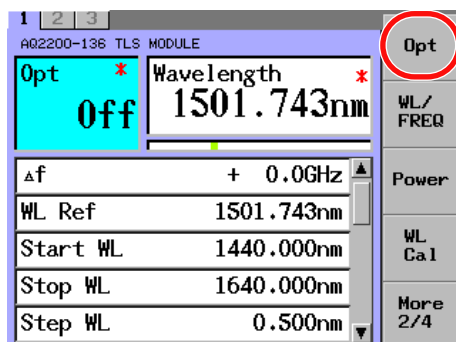

2. Move the cursor using the arrow keys to ON.

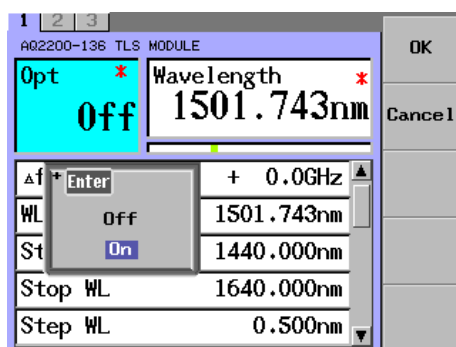

3. Press **ENTER**.

The OPT indication becomes ON.

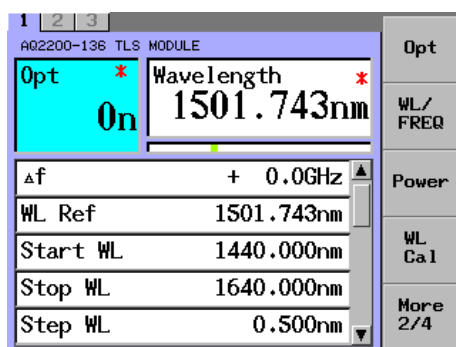

### Note

When "Lock" is displayed in the "Opt" field, the optical output cannot be generated. One of the followings is the cause:

- Interlock connector is open.
- Laser output is locked.

For details on how to generate the output, see section 2.9 "Unlocking the Laser Output" in [Startup Guide] (IM 735101-01EN).

## 5.1 Sets the Tunable Laser Source (TLS Module)

---

### Explanation

Laser output is always off when the instrument starts.

Two kinds of operating procedures are provided to make the ON/OFF setting of the laser output.

- Switch on the front panel of the module is changed.
- Laser output ON/OFF is changed through the menu screen.

Either operation can be used to change the laser output.



### WARNING

Never look at the optical output connector or the top end of the optical fiber connected to the optical output connector while the laser beam is being output. The invisible laser beam cannot be seen. However, if the laser beam enters your eye(s), this may cause eye injury and the eyesight to be ruined excessively.

---

French



### AVERTISSEMENT

Ne jamais regarder le connecteur de sortie optique ou l'extrémité supérieure de la fibre optique raccordée au connecteur optique pendant la génération du faisceau laser. Le faisceau laser est invisible. S'il atteint l'oeil ou les yeux, il peut causer des lésions oculaires et endommager considérablement la vue.

---

## Calibrating the Wavelength

When operating this unit, you must calibrate the wavelength every time the laser output is turned ON. This section describes how to calibrate the wavelength.

### Procedure

1. Press the **WL Cal** soft key.  
The WL Calibration screen will appear.

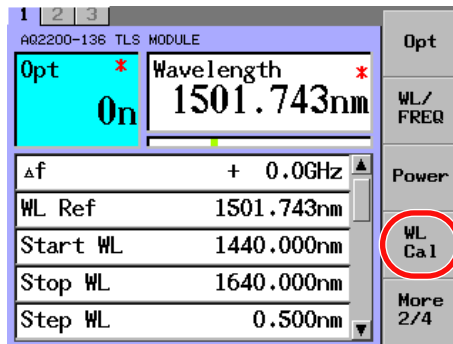

2. The calibration progress status is shown.  
When the calibration is completed successfully, the screen is returned to the initial screen.  
When pressing the **Stop** soft key, the WL Calibration is aborted and the screen is returned to the above screen.

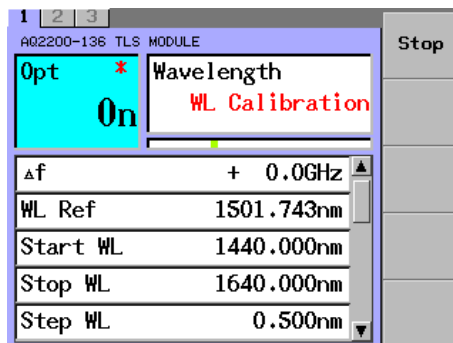

### Note

- Before starting the wavelength calibration, warm up the unit for 1 hr. or longer after the optical output of this unit has been turned ON.
- When executing the warming up operation, it is necessary to put the unit in the laser ON status.
- Once the optical output is turned OFF, the wavelength calibration you have made becomes invalid.
- If the wavelength calibration is not performed, the absolute wavelength accuracy and relative wavelength accuracy specified for this unit cannot be satisfied.
- If an error related to the temperature occurs, the wavelength calibration you have made becomes invalid.

## 5.1 Sets the Tunable Laser Source (TLS Module)

### Explanation

When the wavelength calibration is completed successfully, the screen is returned to the previous screen. At this time, the "\*" indication in the "Opt" and "Wavelength" fields showing that the wavelength calibration is not completed will disappear. Even though the wavelength calibration is not completed successfully, the screen is returned to the previous screen, but the "\*" indication showing that the wavelength calibration is not completed does not disappear (remains).

"\*" indication in "Opt" field: The wavelength calibration is not completed. The actual output level is smaller than the output value displayed on the screen.

"\*" indication in "Wavelength" field: The wavelength calibration is not completed.

"\*" indication showing that the wavelength calibration is not completed.

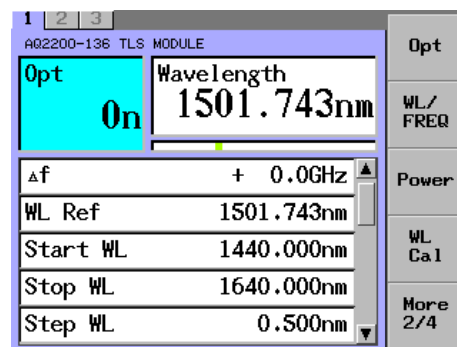

Wavelength Calibration Is Completed.

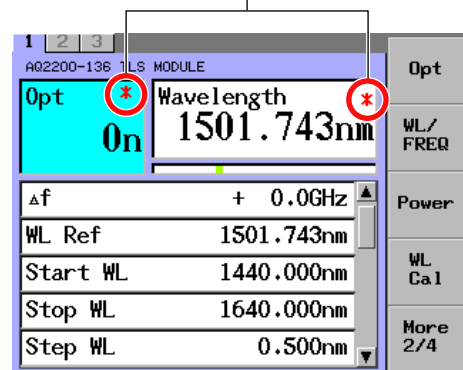

Wavelength Calibration Is Not Completed.

## Sets the Wavelength

When outputting the fixed wavelength value, you must set an output wavelength value. There are two methods to set the wavelength.

- Entering the wavelength value directly
- Setting the wavelength based on a reference wavelength and a step wavelength ( $\Delta f$ )

### Entering the Wavelength Value Directly

#### Procedure

1. Press the **WL/FREQ** soft key. Or use the arrow keys to move the cursor to Wavelength or Frequency, and press **ENTER**.  
The Wavelength or Frequency dialog box appears.

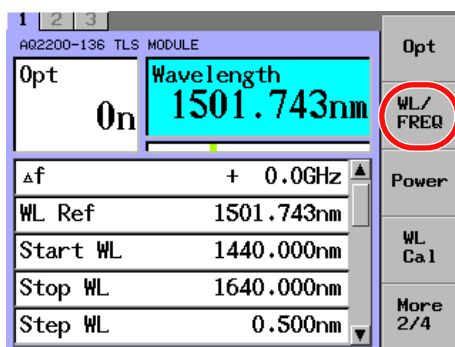

2. Input a desired numeric value through the numeric keypad or with the arrow keys, and then press **ENTER**.

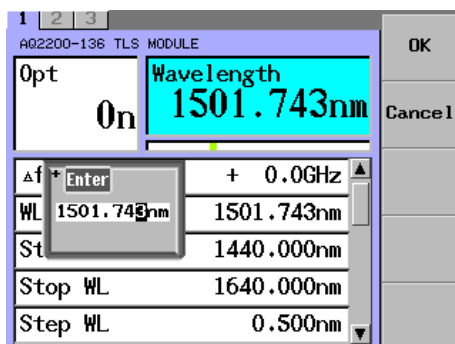

3. Press the **OK** soft key or **ENTER**.  
The value that Wavelength was set to is displayed, and the laser output wavelength switches to the set wavelength.

#### Note

- The wavelength range of the AQ2200-136 is "1440 to 1640 nm".
- The minimum significant digit of the AQ2200-136 you can set is "1/1000 nm".
- When the slot, which is newly inserted into the frame controller, is started up or preset, the initial wavelength is fixed at "1501.743 nm".
- If it is installed in the same slot of the same controller, the wavelength and parameter settings will remain the same after the power is turned on again.

## 5.1 Sets the Tunable Laser Source (TLS Module)

### Explanation

In addition to the setting with the wavelength (nm), you can also make the setting with the frequency (THz). The following description is written assuming that the display unit is wavelength (nm).

The relationship between the wavelength and frequency is shown as follows.

$$f \text{ (THz)} \times 10^{12} = c / (\lambda \text{ (nm)} \times 10^{-9})$$

$\lambda$ : Display wavelength (nm)

$f$ : Display frequency (THz)

$c$ : Light velocity in vacuum ( $2.99792458 \times 10^8$  m/s)

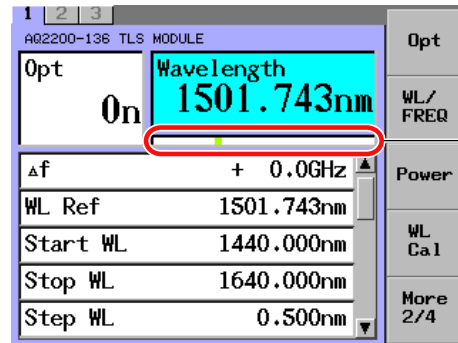

By synchronizing with the value in the "Wavelength" field, the current wavelength is shown by the bar.

According to the Wavelength setting, the current wavelength position within the wavelength range is displayed.

### Note

For the setup procedure of the display unit, see "Changing the Wavelength Display Unit" at page 5-39.

## Setting the Wavelength Based on a Reference Wavelength and a Step Wavelength ( $\Delta f$ )

You can match the wavelength with that of the WDM channel by using the WDM anchor channel as the reference wavelength and integer multiples of the grid frequency as  $\Delta f$ . This section explains how to set the reference waveform and  $\Delta f$ .

### Procedure

#### Setting the Reference Wavelength

1. Press the **WL/FREQ** soft key. Or use the arrow keys to move the cursor to Wavelength or Frequency, and press **ENTER**.  
The Wavelength or Frequency dialog box appears.

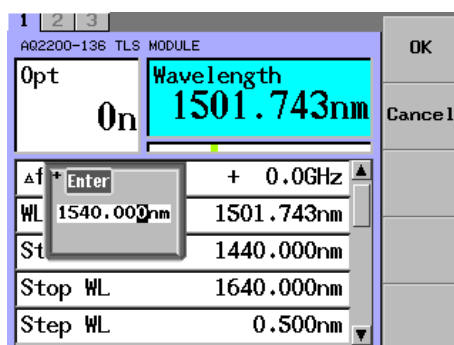

2. Use the numeric keypad or the arrow keys to change the value, and press the **OK** soft key or **ENTER**.

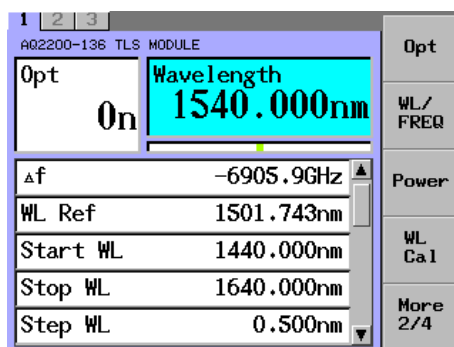

3. Press the **WL -> WLO** soft key.  
The value in the Wavelength field is then set in the WL Ref field.

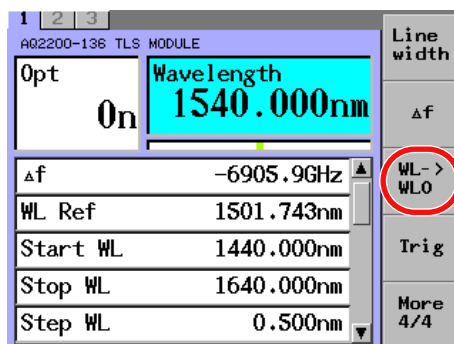

#### Note

When you press WL and then press WLO, the value of  $\Delta f$  changes to 0.0 GHz.

## 5.1 Sets the Tunable Laser Source (TLS Module)

### Setting $\Delta f$

- Press the  $\Delta f$  soft key or move the cursor using the arrow keys to  $\Delta f$ , and then press **ENTER** key.

The  $\Delta f$  dialog box will appear.

Opt	0n	Wavelength	1540.000nm
$\Delta f$			+ 0.0GHz
WL Ref			1540.000nm
Start WL			1440.000nm
Stop WL			1640.000nm
Step WL			0.500nm

- Input a desired numeric value through the numeric keypad or with the arrow keys, and then press **ENTER**.

Opt	0n	Wavelength	1539.992nm
$\Delta f$			+ 1.0GHz
WL Ref			1540.000nm
Start WL			1440.000nm
Stop WL			1640.000nm
Step WL			0.500nm

- The offset value is then added to the value in the Wavelength field.

### Explanation

A desired wavelength within the wavelength range can set for "WL Ref".

"WL Ref" becomes the wavelength reference point when using  $\Delta f$ .

By executing "WL -> WLO", the wavelength set in the "Wavelength" field can be assigned to "WL Ref".

With  $\Delta f$ , you can set a wavelength to the wavelength set in the "WL Ref" field in a range of  $\pm\Delta f$ . The fixed unit of  $\Delta f$  is the frequency (GHz).

The relationship between the set wavelength, reference wavelength, and step wavelength is indicated below.

$$\text{Wavelength (nm)} = c \times 10^9 / \{ (c / \text{WL Ref (nm)} \times 10^{-9}) + \Delta f \text{ (GHz)} \times 10^9 \}$$

Wavelength: Set wavelength (nm)

WL Ref: Reference wavelength (nm)

$\Delta f$ : Step wavelength (THz)

c: Light velocity in vacuum ( $2.99792458 \times 10^8$  m/s)

If you specify the wavelength by configuring the Wavelength setting, the difference between the wavelengths of WL Ref and Wavelength is displayed next to  $\Delta f$ .

The allowable setting range of  $\Delta f$  may depend on the wavelength range of the AQ2200-136.



## Sets the Line Width

A desired line width of the laser can be selected from two settings, one is “Narrow”, which is not modulated and the other is “Wide”, which is modulated.

This section describes how to change the line width.

### Procedure

1. Press the **Linewidth** soft key or move the cursor using the arrow keys to Linewidth, and then press **ENTER**.

The Linewidth dialog box will appear.

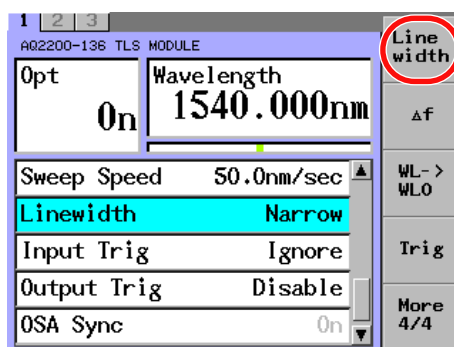

2. Move the cursor using the arrow keys to Linewidth, select the desired line width with the cursor.

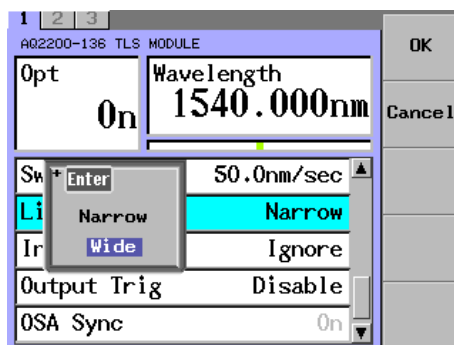

3. Press **ENTER**.

The line width you have set is shown in the Linewidth field.

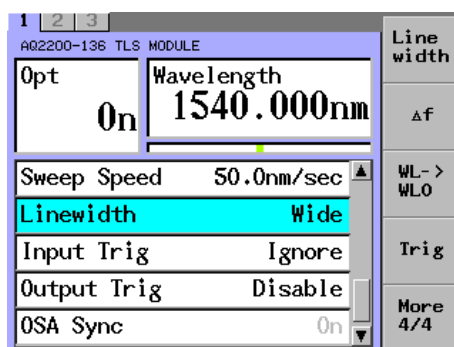

### Explanation

A desired line width can be selected from two types of settings, “Narrow” and “Wide”.

If you set the line width to Wide, white noise is added to the drive current of the semiconductor laser. We recommend that you set the line width to Wide when you want to perform loss measurement and minimize the effect of optical interference and that you set the line width to Narrow when you want apply external modulation to the laser output. Please choose according to how you intend to use the laser.

## Sets the Output Power Level Value

There are three kinds of laser output level setup methods as listed below.

- Setting a specific optical output power
- Setting through auto detection of the maximum laser output value at the fixed wavelength
- Setting through auto detection of the optimal laser output value during sweep

### Procedure

1. Press the **Power** soft key or move the cursor using the arrow keys to Power, and then press **ENTER**.

The Power dialog box will appear.

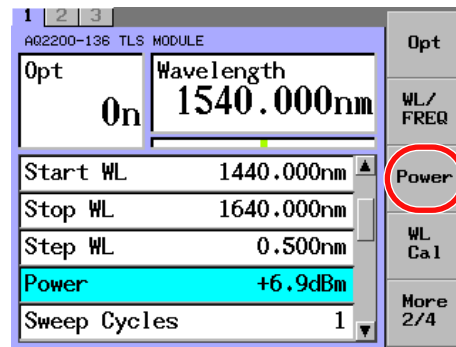

### Setting a Specific Optical Output Power

2. Use the numeric keypad or the arrow keys to change the value, and press the **OK** soft key or **ENTER**.

The specified value appears next to Power.

### Setting the maximum laser output value at the fixed wavelength

2. Press the **Max** soft key.

### Setting the optimal laser output value during sweep

2. Press the **Sweep Max** soft key.

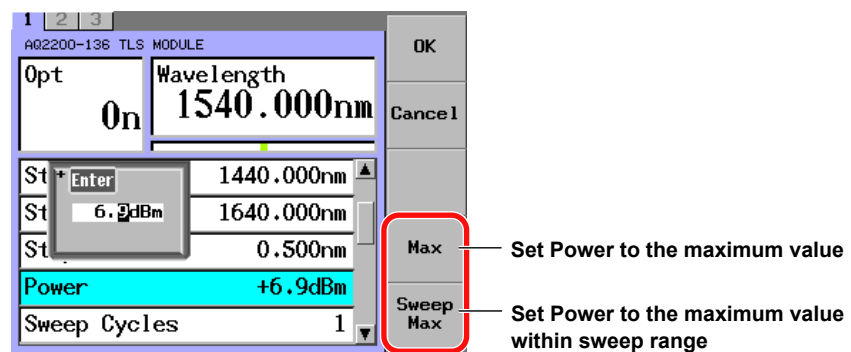

### Note

- In the lower part of the wavelength range of the AQ2200-136, the laser output level is lower than the minimum value for the power range. Within this low wavelength range, if you perform automatic laser output by pressing the Max soft key, the minimum value is displayed next to Power, along with a mark indicating that value has not been reached.
- The AQ2200-136 has its own unique power range.
- If you want to achieve the maximum output at all wavelengths, set Power to the maximum value within the power range.

## Explanation

### Setting the Output Level

- Setting a specific optical output power  
Input a value for Power.
- Automatic Detection of the Maximum Laser Output Value for a Fixed Wavelength  
The maximum output level for the current set wavelength is automatically detected, and Power is set to that value.
- Automatic Detection of Optimum Laser Output Value for Sweeping  
The optimum maximum value for flat laser output during sweeping from Start WL to Stop WL is detected, and Power is set to that value.  
Sweep Max is the automatically detected value within the specified wavelength range at which maximum flatness can be achieved. For details, see section 1.2 “Setting the Power (TLS Module)”.

### Note

- The laser output value has individual setting range for each AQ2200-136.
- The set resolution of the laser output value is 0.1 dB.
- The laser output value range you can input does not meet the actual laser output setting range.
- The connector connection status, environment, and/or secular change may affect the laser output value displayed in the “Power” display field. Therefore, the Power display does not guarantee the set value. The value in the “Power” display field is used as reference value.

### Non-achievement of Laser Output Level

In the AQ2200-136, each laser output variable change range of each module to the laser maximum output level and wavelength is different. For wavelength around the short wavelength (from 1440 nm), since the laser output level does not satisfy the minimum value of the Power set value range, the laser output non-achievement indication “\*” is always shown. However, the specifications stated in the catalog are satisfied.

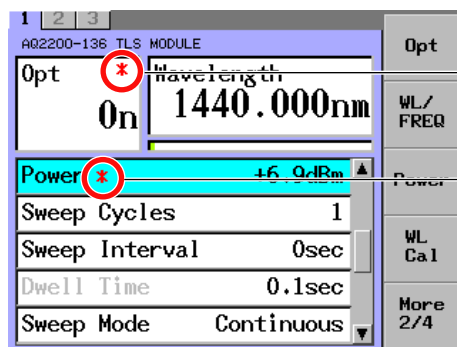

“\*” indication in the “Opt” field is the logical OR of non-achievement of the level and non-execution of the calibration. This shows that the output level in the “Power” setting field is smaller than a display level of +6.9 dBm at a wavelength of 1440 nm.

### Note

- When the laser output non-achievement indication “\*” is displayed, this shows that the display level does not achieve the display level.
- Even though the laser output non-achievement indication is shown, the laser output level stated in the catalog specification is not satisfied.

## Setting Sweep Conditions

You must set sweep conditions before you can sweep. The conditions that you must set are listed below.

- Start wavelength
- Stop wavelength
- Step wavelength
- Sweep cycles
- Sweep interval
- Dwell time
- Sweep speed

There are two places where you can set sweep conditions:

- The setup item and value list.
- The display for each setup item.

### Procedure

#### Setting Sweep Conditions on the Setup Item and Value List

1. Press the **Sweep Cond** soft key to display the setup item and value list.

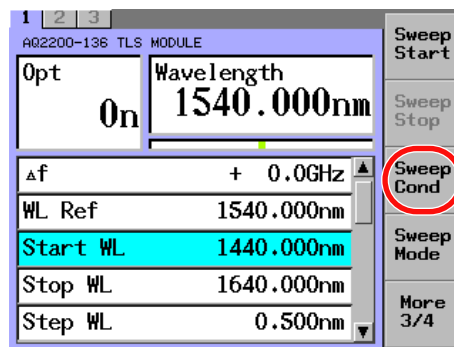

2. Use the arrow keys to move the cursor to a setup item, and press **ENTER**.  
A dialog box for entering a value appears.

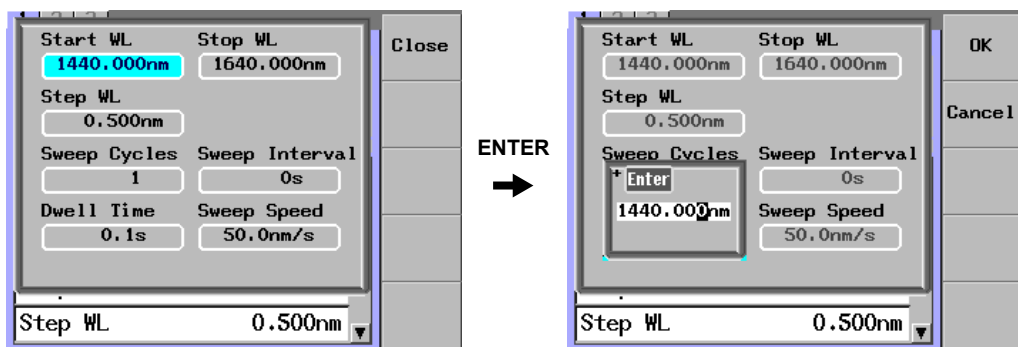

#### Setting Sweep Conditions in the Displays for Various Setup Items

The operations will be explained for each setup item.

## Sets the Sweep Start Wavelength

## Procedure

1. Press the **Sweep Cond** soft key or move the cursor using the arrow keys to Start WL, and then press **ENTER**.

The Start WL dialog box will appear.

If you pressed **Sweep Cond** in step 1, the setup item and value list will appear. Use the arrow keys to move the cursor to Start WL, and press **ENTER**.

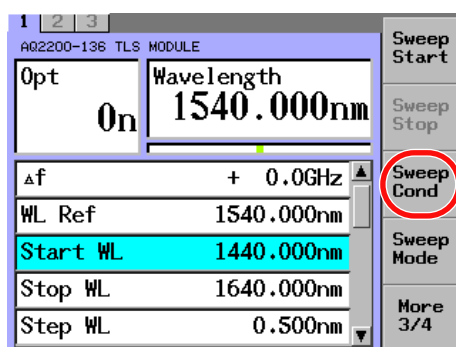

2. Use the numeric keypad or the arrow keys to change the value, and then press **ENTER**.

The numeric value you have set is shown in the Start WL field.

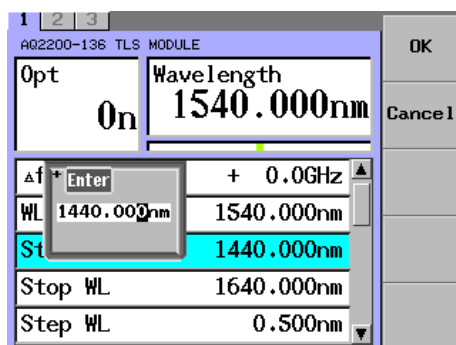
**Note**

- The wavelength setting range is "1440" to "1640 nm". If a value, which is 1440 or less, is set, "1440" is shown. On the contrary, if a value, which is 1640 or more, is set, "1640" is shown.
- The minimum significant digit you can set is "0.001 nm".

### Sets the Sweep Stop Wavelength

#### Procedure

1. Press the **Sweep Cond** soft key or move the cursor using the arrow keys to Stop WL, and then press **ENTER**.

The Stop WL dialog box will appear.

If you pressed **Sweep Cond** in step 1, the Sweep Condition dialog box will appear. Use the arrow keys to move the cursor to Stop WL, and press **ENTER**.

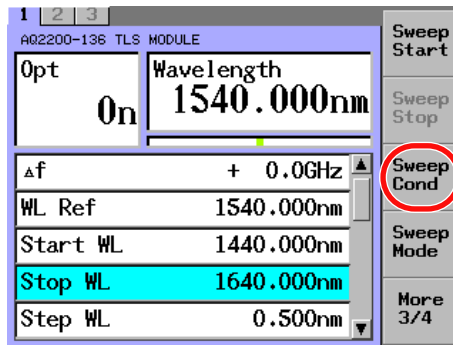

2. On the dialog box, input a desired numeric value through the numeric keypad or with the arrow keys, and then press **ENTER**.

The numeric value you have set is shown in the Stop WL field.

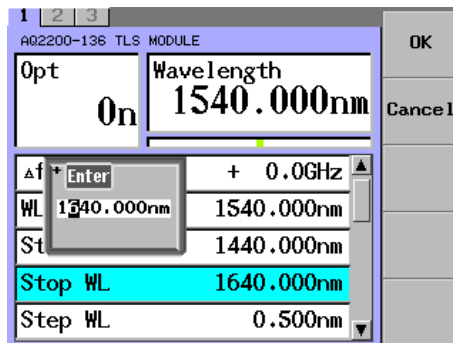

#### Note

- The wavelength setting range is "1440" to "1640 nm". If a value, which is 1440 or less, is set, "1440" is shown. On the contrary, if a value, which is 1640 or more, is set, "1640" is shown.
- The minimum significant digit you can set is "0.001 nm".

## Sets the Sweep Step Wavelength

This section describes how to set the sweep step.

### Procedure

1. Press the **Sweep Cond** soft key or move the cursor using the arrow keys to Step WL, and then press **ENTER**.

The Step WL dialog box will appear.

If you pressed **Sweep Cond** in step 1, the Sweep Condition dialog box will appear. Use the arrow keys to move the cursor to Step WL, and press **ENTER**.

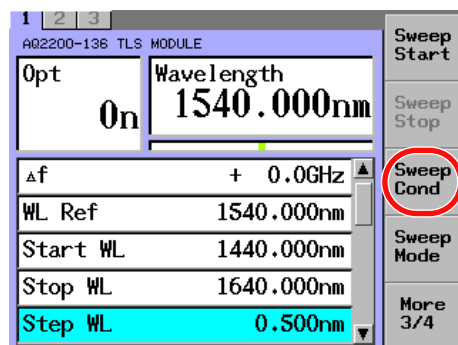

2. On the dialog box, input a desired numeric value through the numeric keypad or with the arrow keys, and then press **ENTER**.

The numeric value you have set is shown in the Step WL field.

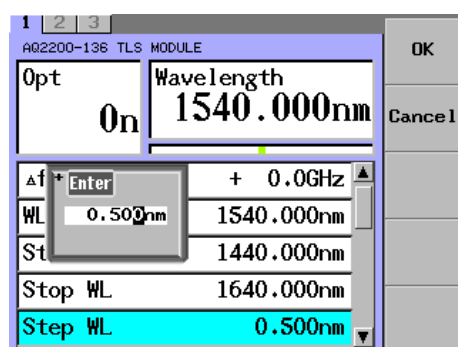

### Note

- The wavelength setting step is "0.001" to "100.000 nm".
- The minimum significant digit you can set is "0.001 nm".

## 5.1 Sets the Tunable Laser Source (TLS Module)

### Sets the Sweep Cycles

The number of repetition measurement cycles with the same parameters can be set for the sweep cycles. The following Table shows the Sweep Modes, in which the “Sweep Cycles” setting becomes valid.

Sweep Mode	Valid	Invalid
Stepped	Yes	
Manual		Yes
Continuous	Yes	

### Procedure

1. Press the **Sweep Cond** soft key or move the cursor using the arrow keys to Sweep Cycles, and then press **ENTER**.

The Sweep Cycles dialog box will appear.

If you pressed **Sweep Cond** in step 1, the Sweep Condition dialog box will appear. Use the arrow keys to move the cursor to Sweep Cycles, and press **ENTER**.

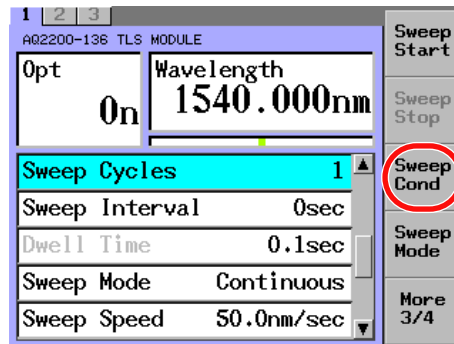

2. On the dialog box, input a desired numeric value through the numeric keypad or with the arrow keys, and then press **ENTER**.

The numeric value you have set is shown in the Sweep Cycles field.

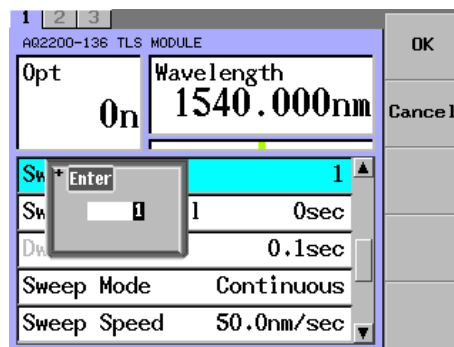

### Note

- When you combine the Sweep Cycles setting with the Sweep Interval setting, you can do things like perform sweeps every hour for nine hours.
- The allowable setting range is 0 to 99999 cycles.
- If you set Sweep Cycles to 0, sweeping repeats infinitely.



## Sets the Sweep Interval

A period of interval time between completion of the previous measurement and start of the next time during continuous measurement can be set for the sweep interval. The following Table shows the Sweep Modes, in which the “Sweep Interval” setting becomes valid.

Sweep Mode	Valid	Invalid
Stepped	Yes	
Manual		Yes
Continuous	Yes	

### Procedure

1. Press the **Sweep Cond** soft key or move the cursor using the arrow keys to Sweep Interval, and then press **ENTER**.

The Sweep Interval dialog box will appear.

If you pressed **Sweep Cond** in step 1, the Sweep Condition dialog box will appear. Use the arrow keys to move the cursor to Sweep Interval, and press **ENTER**

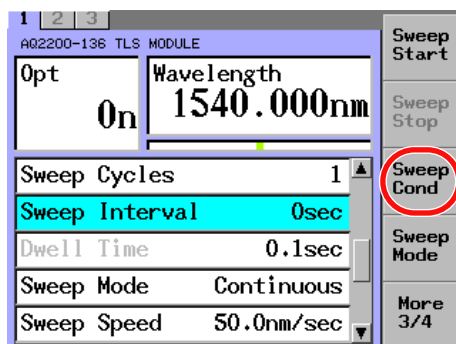

2. On the dialog box, input a desired numeric value through the numeric keypad or with the arrow keys, and then press **ENTER**.

The numeric value you have set is shown in the Sweep Interval field.

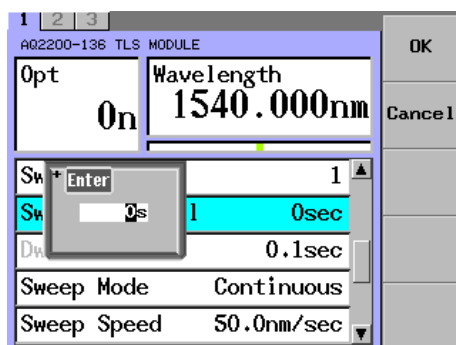

## 5.1 Sets the Tunable Laser Source (TLS Module)

---

### Explanation

The sweep interval counts a period of time from standby at the start wavelength. The sweep interval does not include a period of time necessary to return from the end wavelength to the start wavelength.

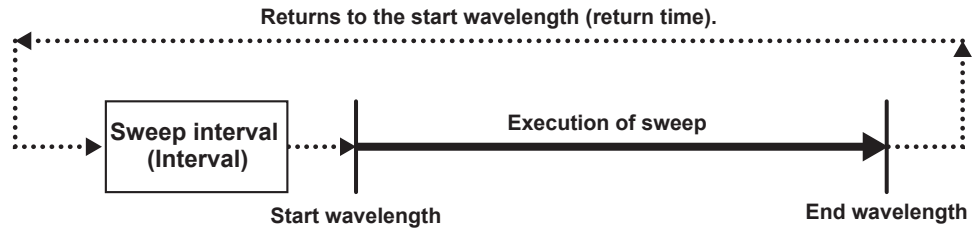

### Note

- It is possible to combine the "Sweep Interval" setting with the "Sweep Cycles" setting.
  - The allowable setting range is 0 to 99999 sec.
  - According to the wavelength sweeping range, the return time to the start wavelength is added to the sweep interval. Therefore, the measurement interval is different from the sweep interval.
-

## Sets the Dwell Time (Lock Time per Wavelength)

For the dwell time, a period of time to lock the wavelength is set. The following Table shows the Sweep Modes, in which the “Dwell Time” setting becomes valid.

Sweep Mode	Valid	Invalid
Stepped	Yes	
Manual		Yes
Continuous		Yes

### Procedure

1. Press the **Sweep Cond** soft key or move the cursor using the arrow keys to Dwell Time, and then press **ENTER**.

The Dwell Time dialog box will appear.

If you pressed **Sweep Cond** in step 1, the Sweep Condition dialog box will appear. Use the arrow keys to move the cursor to Dwell Time, and press **ENTER**.

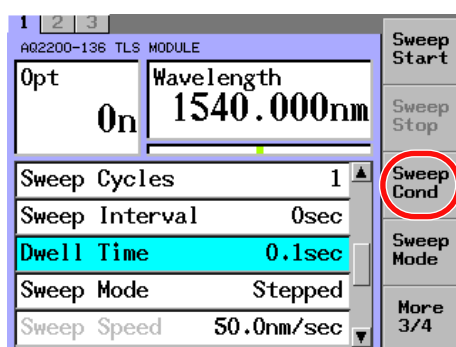

2. On the dialog box, input a desired numeric value through the numeric keypad or with the arrow keys, and then press **ENTER**.

The numeric value you have set is shown in the Dwell Time field.

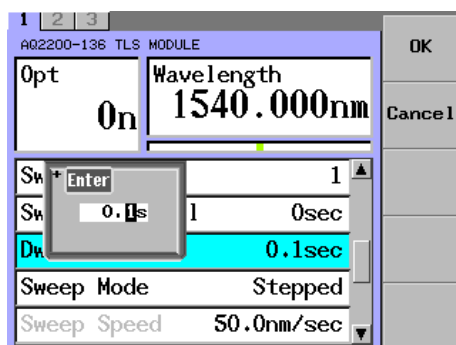

## 5.1 Sets the Tunable Laser Source (TLS Module)

---

### Explanation

The dwell time shows a period of time from locking of the wavelength at the set level to starting of the movement to the next wavelength. The dwell time does not include the movement time to the next wavelength.

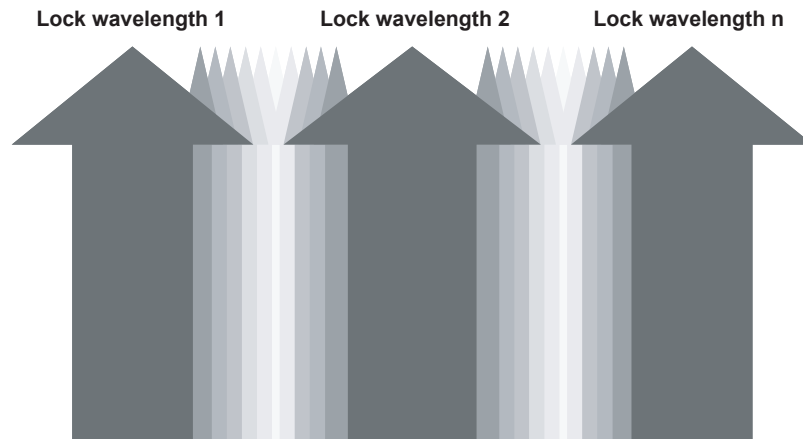

### Note

---

The allowable setting range is 0.1 to 999.9 sec.

---

## Sets the Sweep Speed in the Continuous Sweep Mode

The sweep speed setup provides the following functions.

Manual setup: A sweep speed ranging from the maximum speed calculated from the Step wavelength to "0.2 nm/s" can be set.

Auto setup: The sweep speed setting is automatically detected from the input Step wavelength.

### Procedure

1. Press the **Sweep Cond** soft key or move the cursor using the arrow keys to Sweep Speed, and then press **ENTER**.  
The Sweep Speed dialog box will appear.

If you pressed **Sweep Cond** in step 1, the Sweep Condition dialog box will appear. Use the arrow keys to move the cursor to Sweep Speed, and press **ENTER**.

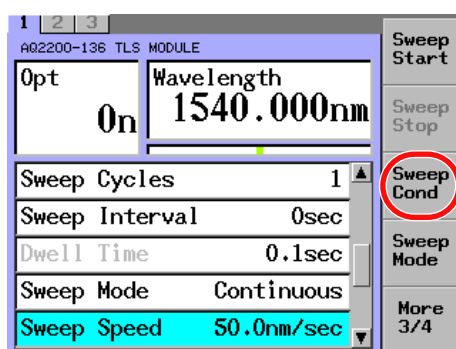

### Manual Setup

2. Move the cursor using the arrow keys to Manual, and then press the **OK** soft key.

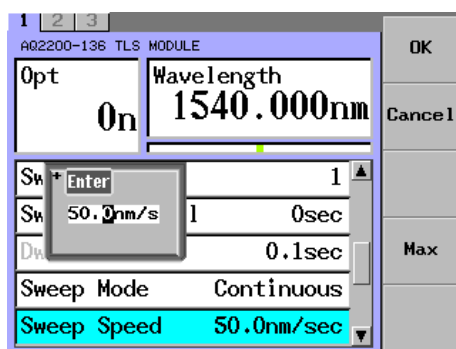

### Auto Setup

2. Move the cursor using the arrow keys to Max, and then press **ENTER**.

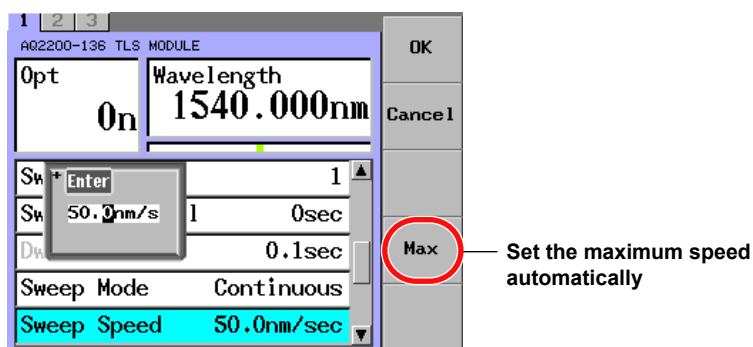

## 5.1 Sets the Tunable Laser Source (TLS Module)

The automatically set value is then shown in the Sweep Speed field.

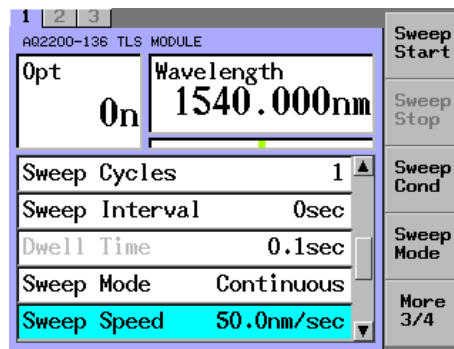

### Explanation

The sweep speed indicates the amount of wavelength shift over time. Normally, the sweep speed is set at 50 nm/s, that is, the fastest mode.

The sweep speed may depend on the "Step WL" setting. A sweep speed of "50 nm/s" cannot be set for all "Step WL" settings. Because the upper limits of the various sweep speeds are determined by the Step WL setting, if you start sweeping under a condition in which the upper limit has been exceeded, the error appears.

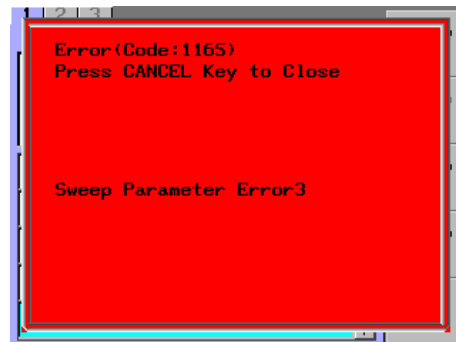

If the Step wavelength is changed after the sweep speed has been detected automatically, the automatically detected value becomes invalid.

## 5.2 Executes the Sweep

There are four kinds of laser output sweep methods as listed below.

- Manual sweep
- Step sweep
- Continuous sweep
- Trigger sweep

### Manual Sweep

This manual sweep function moves the wavelength to the next wavelength with the key operation. This function is convenient to individually evaluate the details at relevant wavelength. First, the operation mode is set to the manual mode, and then the sweep is performed with the key operation.

#### Procedure

##### Setting the Operation Mode to Manual

1. Press the **Sweep Mode** soft key or move the cursor using the arrow keys to Sweep Mode, and then press **ENTER**.

The Sweep Mode dialog box will appear.

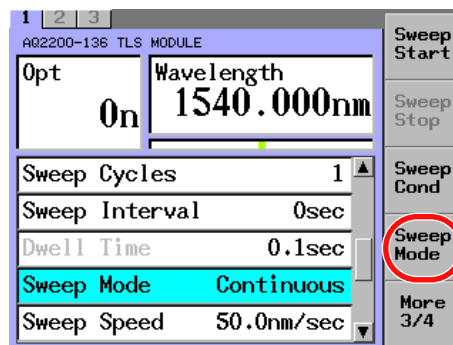

2. Move the cursor using the arrow keys to Manual, and then press **ENTER**. Manual is shown in the Sweep Mode field.

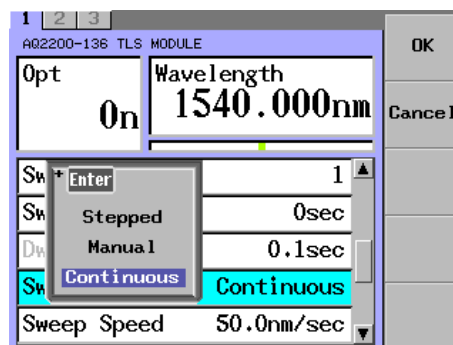

## 5.2 Executes the Sweep

### Sweeping by Using Keys

3. Press the **Sweep Start** soft key to move to Start WL and wait.

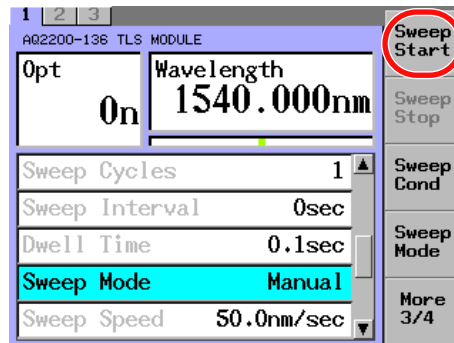

4. When pressing the **Next** soft key, the movement to the next wavelength is started. Press the **Stop** soft key to move to Start WL and return to the previous display.

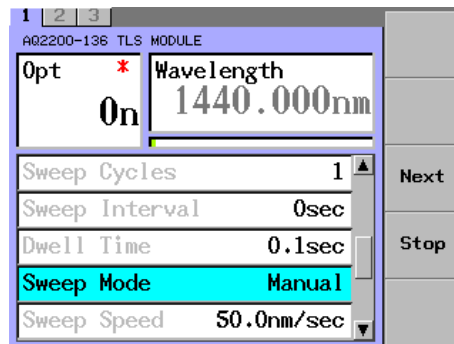

### Explanation

The setup items other than valid setup items are dimmed.

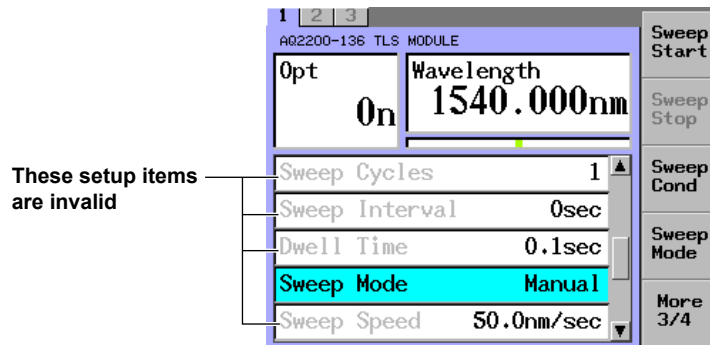



## The Step Sweep

In step sweeping, the wavelength is automatically shifted from Start WL to Stop WL in steps whose size is determined by Step WL.

First, the operation mode is set to the step mode, and then the sweep is performed.

### Procedure

#### Setting the Operation Mode to Step

1. Press the **Sweep Mode** soft key or move the cursor using the arrow keys to Sweep Mode, and then press **ENTER**.

The Sweep Mode dialog box will appear.

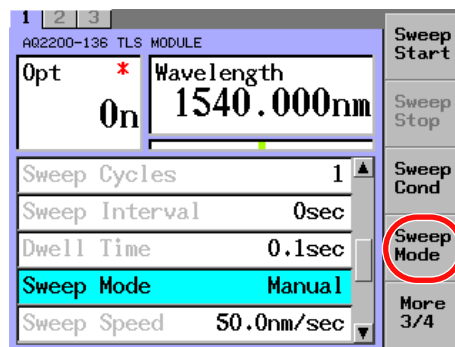

2. Move the cursor using the arrow keys to Stepped, and then press the **OK** soft key or **ENTER**.

Stepped is shown in the Sweep Mode field.

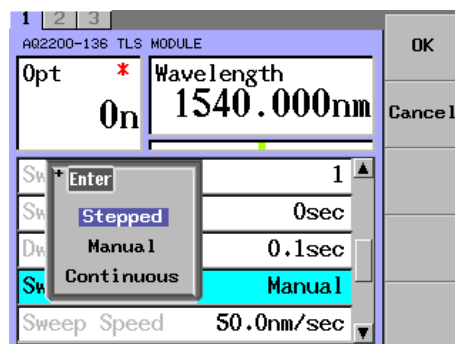

### Starting the Sweep with the Key Operation

- 4. When pressing the **Sweep Start** soft key, the sweep is started.

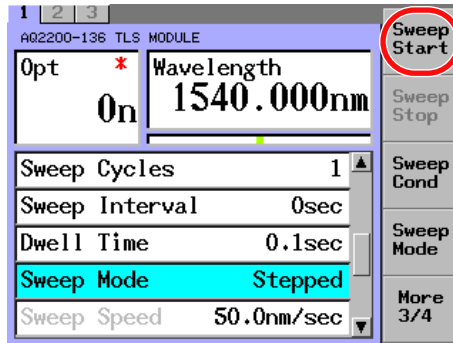

- 5. When pressing the **Pause** soft key, the sweep is stopped temporarily. Pressing the **Stop** soft key will exit the sweep.

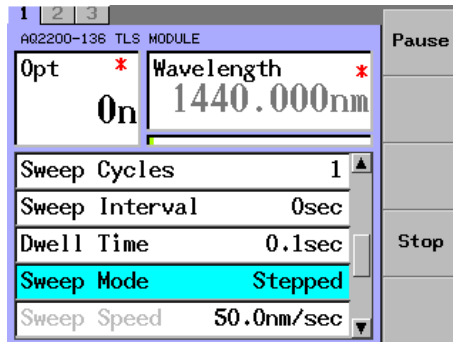

- 6. When pressing the **Cont** soft key, the temporary stop of the sweep is cancelled. Pressing the **Stop** soft key will exit the sweep.

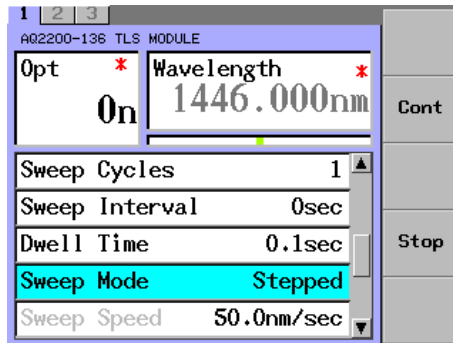

## The Continuous Sweep

This continuous sweep function variably changes the wavelength within the sweep range to continuously output it.

### Procedure

#### Setting the Operation Mode to Continuous

1. Press the **Sweep Mode** soft key or move the cursor using the arrow keys to Sweep Mode, and then press **ENTER**.

The Sweep Mode dialog box will appear.

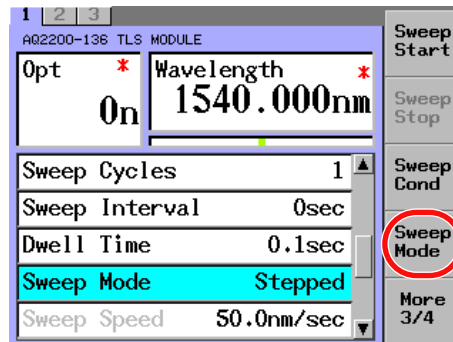

2. Move the cursor using the arrow keys to Continuous, and then press the **OK** soft key or **ENTER**.

Continuous is shown in the Sweep Mode field.

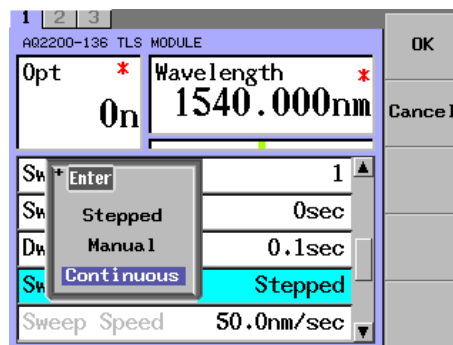

5.2 Executes the Sweep

Starting the Sweep with the Key Operation

3. When pressing the **Sweep Start** soft key, the sweep is started.

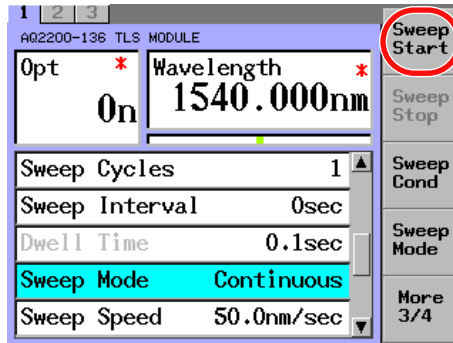

4. Pressing the **Stop** soft key will exit the sweep.

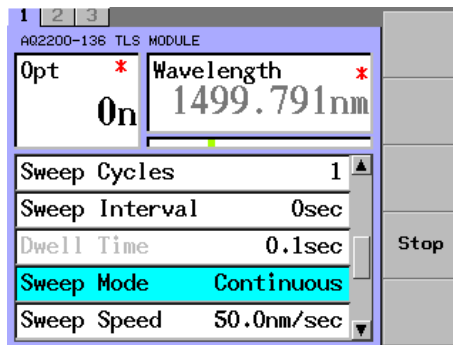

**Explanation**

The following Table shows the valid setup items in each Sweep Mode.

Yes: Valid, No: Invalid

	Manual Sweep	Stepped Sweep	Continuous Sweep
Start WL	Yes	Yes	Yes
Stop WL	Yes	Yes	Yes
Step WL	Yes	Yes	Yes
Sweep Cycle	No	Yes	Yes
Sweep Interval	No	Yes	Yes
Dwell Time	No	Yes	No
Sweep Speed	No	No	Yes

Unavailable setup items are dimmed.

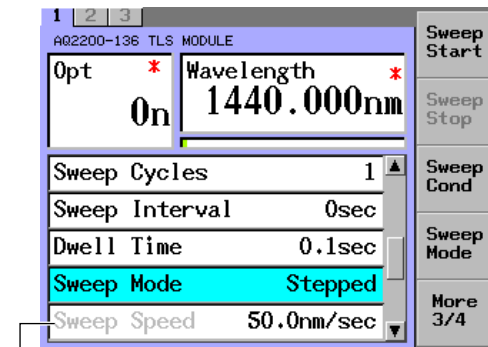

Setup items are invalid

## The Trigger Sweep

Two kinds of trigger modes are provided and an optimal trigger mode can be selected.

- Mode without use of input trigger: Ignore
- Mode, in which the sweep is started with the input trigger: Sweep Start

For details about how to input the trigger, see section 8.1 in the IM 735101-04EN.

### Procedure

#### Mode without Use of Input Trigger

1. Press the **Trig** soft key or move the cursor using the arrow keys to Input Trig, and then press **ENTER**.

The Input Trigger dialog box will appear.

If you pressed Trig in step 1, the Trigger dialog box will appear. Use the arrow keys to move the cursor to Input Trigger, and then press **ENTER**.

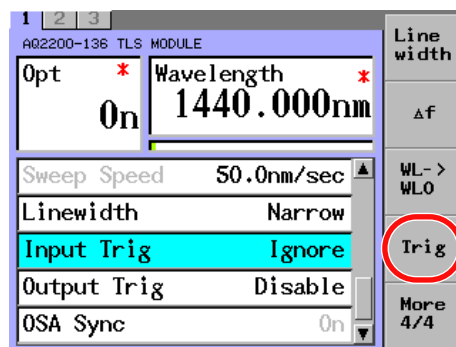

2. Move the cursor using the arrow keys to Ignore, and then press the **OK** soft key or **ENTER**.

Ignore is shown in the Input Trig field.

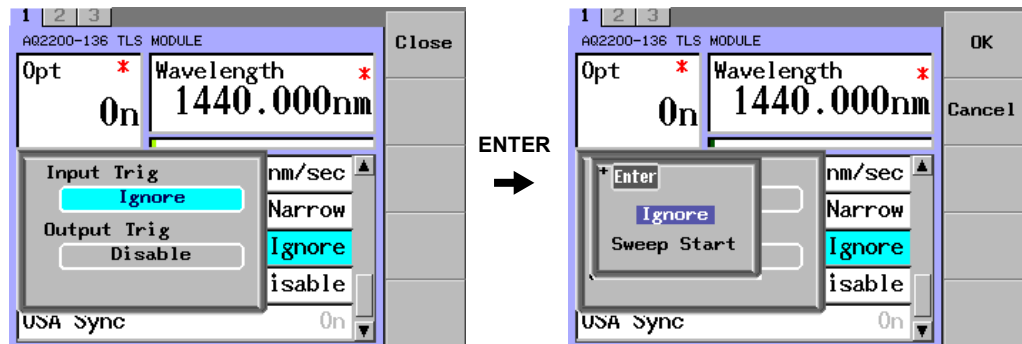

## 5.2 Executes the Sweep

### Mode, in which the Sweep Is Started with the Input Trigger

1. Press the **Trig** soft key or move the cursor using the arrow keys to Input Trig, and then press **ENTER**.

The Input Trigger dialog box will appear.

If you pressed **Trig** in step 1, the Trigger dialog box will appear. Use the arrow keys to move the cursor to Input Trigger, and then press **ENTER**.

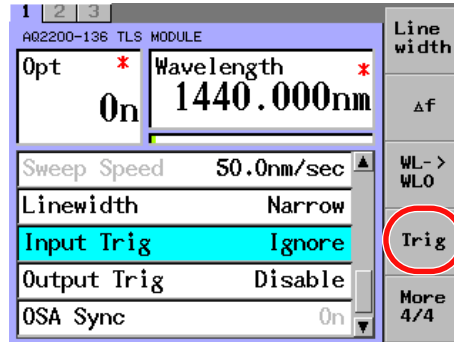

2. Move the cursor using the arrow keys to Sweep Start, and then press **ENTER**. Sweep Start is shown in the Input Trig field.

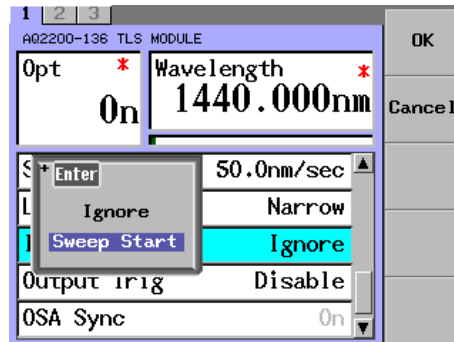

### Explanation

#### Valid Input Trigger Modes During Sweep Measurement

	Manual Sweep	Stepped Sweep	Continuous Sweep
Ignore	Yes	Yes	Yes
Sweep Start	Yes	Yes	Yes

## 5.3 Trigger Output

The trigger can be output to the outside every time the sweep conditions, which have been specified, are executed.

There are four conditions shown below.

- Making the trigger output disabled: Disable
- Outputting the trigger at each sweep step: Step Finished
- Outputting the trigger after completion of the sweep: Sweep Finished
- Outputting the trigger after starting of the sweep: Sweep Started

### Making the Trigger Output Disabled

#### Procedure

1. Press the **Trig** soft key or move the cursor using the arrow keys to Output Trig, and then press **ENTER**.

The Output Trigger dialog box will appear.

If you pressed **Trig** in step 1, the Trigger dialog box will appear. Use the arrow keys to move the cursor to Output Trigger, and then press **ENTER**.

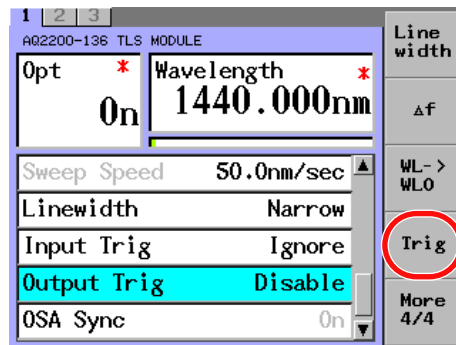

2. Move the cursor using the arrow keys to Disable, and then press **ENTER**.

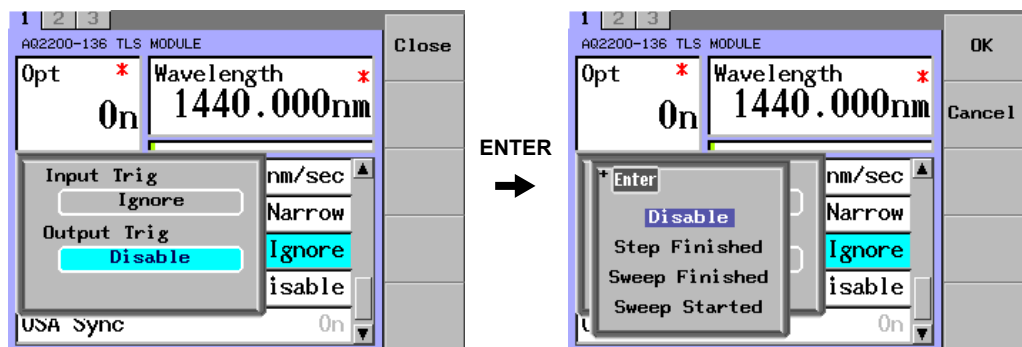

## Outputting the Trigger at each sweep step

The trigger is transmitted whenever the wavelength of a step is reached.

### Procedure

1. Press the **Trig** soft key or move the cursor using the arrow keys to Output Trig, and then press **ENTER**.

The Output Trigger dialog box will appear.

If you pressed **Trig** in step 1, the Trigger dialog box will appear. Use the arrow keys to move the cursor to Output Trigger, and then press **ENTER**.

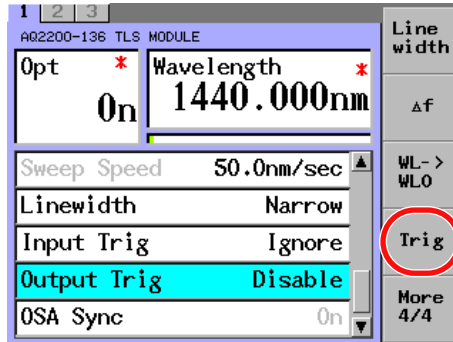

2. Move the cursor using the arrow keys to Step Finished, and then press **ENTER**. Step Finished is shown in the Output Trig field.

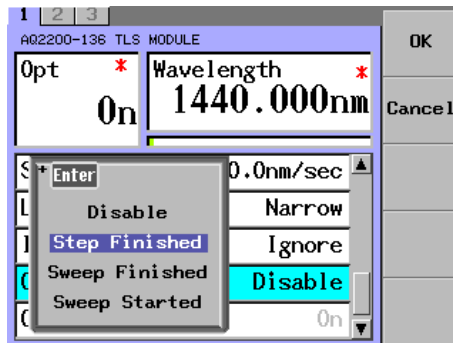



## Outputting the Trigger after Completion of the Sweep

### Procedure

1. Press the **Trig** soft key or move the cursor using the arrow keys to Output Trig, and then press **ENTER**.

The Output Trigger dialog box will appear.

If you pressed **Trig** in step 1, the Trigger dialog box will appear. Use the arrow keys to move the cursor to Output Trigger, and then press **ENTER**.

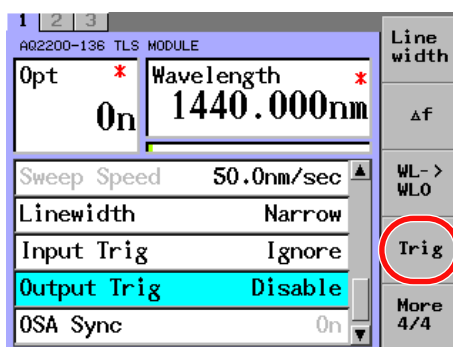

2. Move the cursor using the arrow keys to Sweep Finished, and then press **ENTER**. Sweep Finished is shown in the Output Trig field.

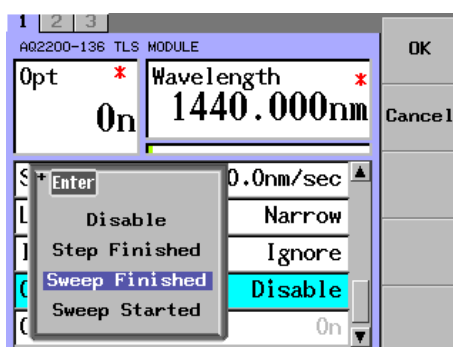

## Outputting the Trigger after Starting of the Sweep

### Procedure

1. Press the **Trig** soft key or move the cursor using the arrow keys to Output Trig, and then press **ENTER**.

The Output Trigger dialog box will appear.

If you pressed **Trig** in step 1, the Trigger dialog box will appear. Use the arrow keys to move the cursor to Output Trigger, and then press **ENTER**.

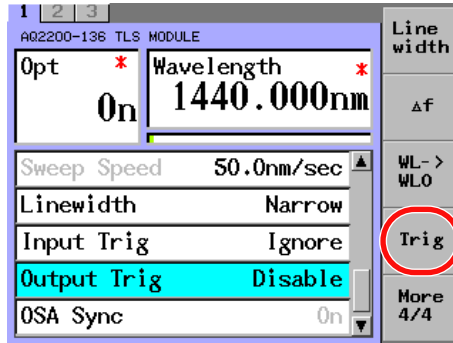

2. Move the cursor using the arrow keys to Sweep Started, and then press **ENTER**. Sweep Started is shown in the Output Trig field.

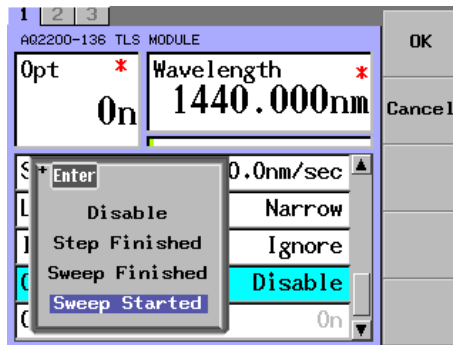

**Explanation**

- **Disable**  
Making the trigger output disabled (Default setting)
- **Step-Finished**  
The trigger is transmitted whenever the wavelength of a step is reached.
- **Sweep-Finished**  
Outputting the trigger after completion of the sweep
- **Sweep-Started**  
Outputting the trigger after starting of the sweep

**Valid Output Trigger Modes during Sweep Measurement**

	Manual Sweep	Stepped Sweep	Continuous Sweep
Disable	Yes	Yes	Yes
Step Finished	Yes	Yes	Yes
Sweep Finished	Yes	Yes	Yes
Sweep Started	Yes	Yes	Yes

## 5.4 Others

### Changing the Power Display Unit

Either [dBm] or [W] can be selected for the wavelength display unit of Power. This section describes how to change the power display unit.

#### Procedure

1. Press the **Unit** soft key.  
The Unit dialog box will appear.

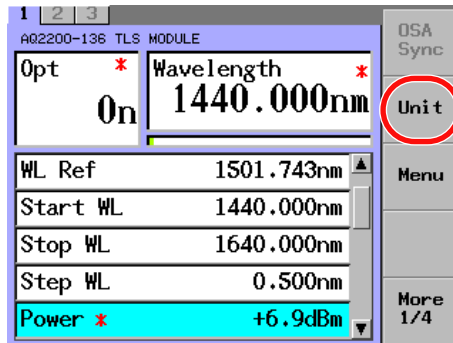

2. Move the cursor using the arrow keys to Power Unit, and then press **ENTER**.  
The Power display unit dialog box will appear.

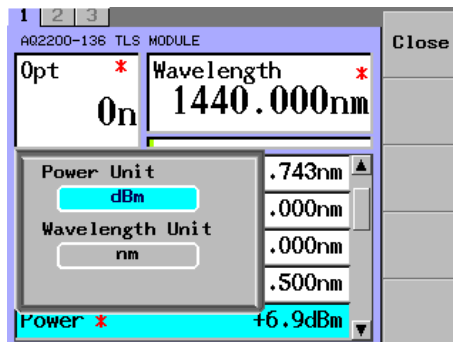

3. Scroll the dialog box display with the arrow keys to move the cursor to dBm or W, and then press the **OK** soft key or **ENTER**.  
The unit for Power display will change.

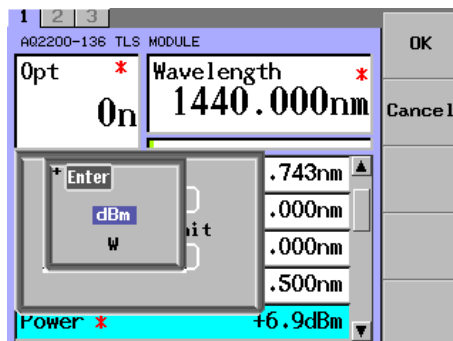

#### Explanation

It is possible to switch the display between the dBm display and W display. The wavelength and frequency are calculated from the following formula.

$$\text{PdBm} = 10 \log P_w$$

P<sub>w</sub>: Optical power (mW)

P<sub>dBm</sub>: Optical power (dBm)

## Changing the Wavelength Display Unit

Either “Wavelength” [nm] or “Frequency” [THz] can be selected for the display unit. This section describes how to change the display unit from “Wavelength” (wavelength) to “Frequency” (frequency).

### Procedure

1. Press the **Unit** soft key.  
The Unit dialog box will appear.

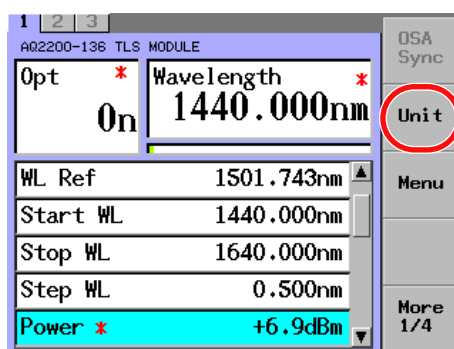

2. Move the cursor using the arrow keys to Wavelength, and then press **ENTER**.  
The Wavelength display unit dialog box will appear.

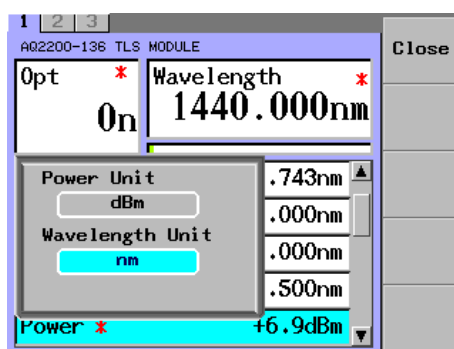

3. Scroll the dialog box display with the arrow keys to move the cursor to nm or THz, and then press the **OK** soft key or **ENTER**.  
The Wavelength display will change to Frequency.

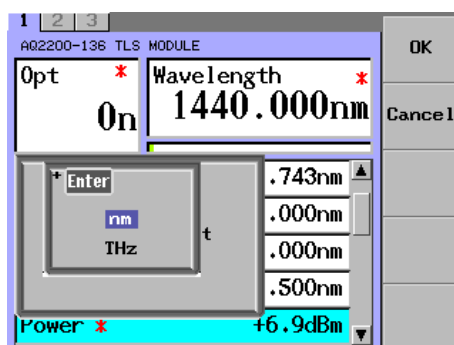

### Explanation

It is possible to switch the display between the dBm display and W display.  
The wavelength and frequency are calculated from the following formula.

$$P_{dBm} = 10 \log P_w$$

$P_w$ : Optical power (mW)

$P_{dBm}$ : Optical power (dBm)

It is possible to switch the display between the wavelength display and frequency display.  
The wavelength and frequency are calculated from the following formula.

$$\lambda \text{ display (nm)} \times 10^{-9} = C / (f_{\text{display (THz)}} \times 10^{12})$$

$\lambda$  display: Display wavelength (nm)

$f_{\text{display}}$ : Display frequency (THz)

C: Light velocity in vacuum ( $2.99792458 \times 10^8$  m/s)

## Synchronous Sweep with AQ6370C Optical Spectrum Analyzer

By combining this unit with the AQ6370C Optical Spectrum Analyzer, the synchronous sweep measurement can be performed. This section describes how to set the synchronous sweep measurement. The wavelength for the synchronous sweep of the AQ2200-136 and optical spectrum analyzer is 1440 to 1640 nm. In this measurement system, points where cannot be measured correctly due to effects of the humidity exist close to the short wavelength (1440 to 1510 nm) of the allowable sweep range.

The cause of this trouble is that the atmospheric moisture content existing on the optical path inside the optical spectrum analyzer absorbs the light to be measured. The measurement value is changed by the atmospheric status and/or wavelength reproducibility of the measurement system every time the measurement is performed. Additionally, since the optical path of the optical spectrum analyzer is longer than that of the optical power meter due to its measuring principle, the humidity may adversely affect the optical spectrum analyzer easily.

To improve this effect, it is necessary to control the humidity around the optical spectrum analyzer.

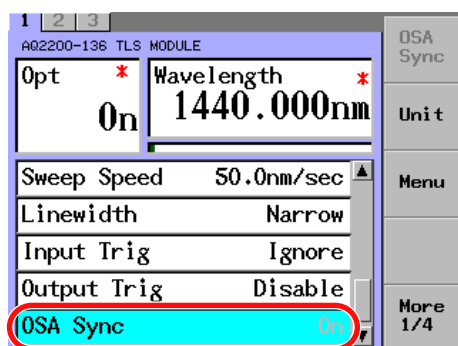

When mounting this unit on the Frame Controller, this item is fixed at "ON".

Follow the steps below to connect AQ2200-136 and AQ6370C.

1. Connect the GP-IB connector on the rear of the Frame Controller and the GP-IB2 connector on the AQ6370C with the GP-IB cable.
2. Connect TRIGGER OUT on the rear of the Frame Controller and TRG MODE SMPL TRG IN on the AQ6370C with the coaxial cable.
3. Connect TRIGGER IN on the rear of the Frame Controller and TLS SYNC OUT on the AQ6370C with the coaxial cable.

When measuring an object device to be measured, first start the sweep with the AQ2200-136 connected to the AQ6370C using the short fiber to perform the reference measurement. Additionally, it is absolutely necessary that the difference in wavelength between AQ2200-136 and AQ6370C is smaller than the resolution set on the AQ6370C. To satisfy this condition, the resolution of the AQ6370C is set to 2.0 nm.

For details about how to set the resolution, see the User's Manual for AQ6370C.

The setup items you must set on the TLS module are WL Cal (wavelength calibration), Linewidth (line width), and Power (optical output level).

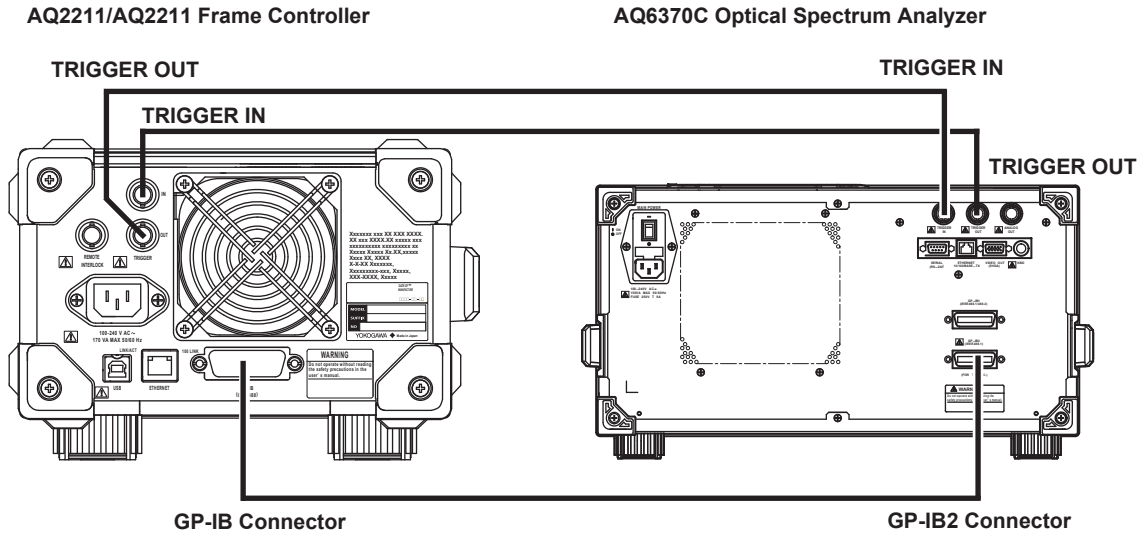

Connection Diagram for Synchronous Sweep of AQ2200-136 and AQ6370C

### Operating the AQ6370C

#### Setting the GP-IB Address

- **Setting the GP-IB Address of the Turnable Laser Source**

1. Press **SYSTEM**.
2. Press the **MORE 1/4** soft key.  
The MORE 2/4 soft key menu is displayed.
3. Press the **GP-IB SETTING** soft key.
4. Press the **TLS ADDRESS** soft key.  
The address setting screen is displayed.
5. Enter the GP-IB address of the turnable laser source connected to the instrument using the rotary knob, arrow keys, or numeric key pad.
6. Enter a numerical value, then press **ENTER**.

- **Setting the GP-IB2 Port Address**

7. Press the **GP-IB2 PORT ADDRESS** soft key.  
The address setting screen is displayed.
8. Enter the instrument's GP-IB2 port address using the rotary knob, arrow keys, or numeric key pad.

#### Note

- When performing TLS synchronous sweep, sample trigger, sweep trigger, and sweep status output (trigger output) cannot be performed.
- Make sure that the GP-IB2 port address is not the same as that of the AQ2211/AQ2212.
- The GP-IB address of the AQ2211/AQ2212 is set to 20 when shipped out from the factory. The initial GP-IB2 port address is 2.

#### Executing Synchronous Sweep

9. Confirm that the **SYSTEM CONTROLLER** soft key in the soft key menu in step 4 is turned ON.
10. Press **SETUP**.
11. Press the **MORE1/2** soft key.



12. Press the **TLS SYNC SWEEP** soft key.  
It turns ON.
13. Press the **SWEEP** key.
14. Press the **REPEAT** or **SINGLE** soft key.  
The turnable laser sources wavelength sweeps in conjunction with the instrument.

---

**Note**

- The resolution setting for the function is fixed to 2 nm.
  - Wavelength mode is set to vacuum wavelength mode.
  - make sure that the span does not exceed the turnable width of the turnable laser source.
  - Set the output power and line width of the tunable laser source in advance.
  - Synchronous sweeping cannot be performed in pulse light measurement mode while "AUTO" measurement is being performed.
-

## 6.1 Configuring the Grid Wavelength Light Source (Grid TLS Module)

Supported on firmware version (FIRM VER) 3.00 and later.

The operation screens of the AQ2200-131 are used in the explanations below. If you are using the AQ2200-132, refer to the operation screen below, and configure each channel.

- Example of an AQ2200-132 detail screen

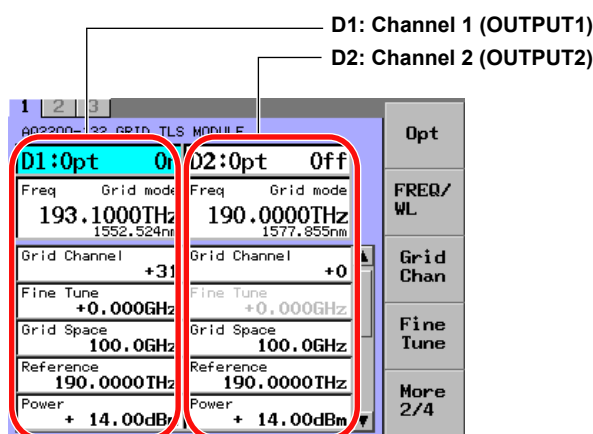

### Soft Key Menu List

Displayed Name	Explanation
Opt	Turns the laser output on and off
FREQ/WL	Sets the output frequency (wavelength)
Grid Chan	Sets the grid number
Fine Tune	Fine-tunes the output frequency
Grid Space	Sets the frequency spacing between grid lines
Ref	Sets the frequency to use as the grid number reference (channel 0)
Power	Sets the output power value
ATT	Sets the output power attenuation
Dither	Selects dither (laser output modulation)
PL Offset	Sets the output power offset
Freq Offset	Sets the output frequency offset
Grid Mode	Turns the grid mode on and off
Unit	Selects the displayed unit
Menu	Information

### Turning ON/OFF the Laser Output

To turn ON or OFF the laser output, two setting methods are provided.

Select a desired setting method corresponding to the application.

Follow the steps below to turn ON or OFF the laser output.

When you turn on the laser output, the module panel LED blinks until the output stabilizes. When it stabilizes, the LED turns on.

### Procedure

#### Setting through the Panel of the Grid TLS Module

Press **OUTPUT** on the Grid TLS panel to switch the light source between ON and OFF each time you press the key.

## 6.1 Configuring the Grid Wavelength Light Source (Grid TLS Module)

### Setting through the Panel of the Frame Controller

1. Press **DETAIL** to display the DETAIL screen.
2. Use the **SLOT** keys to select the Grid TLS module as the current module.
3. Press the **Opt** soft key or move the cursor using the arrow keys to Opt and press **ENTER**.

The dialog box will appear.

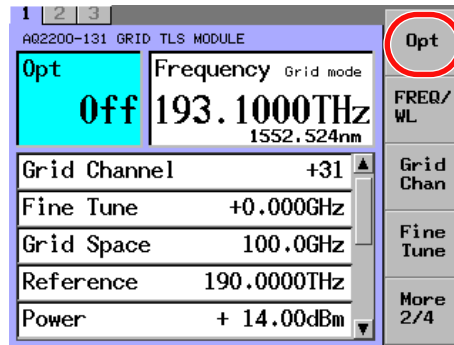

4. Move the cursor using the arrow keys to either of On or Off and press the **OK** soft key or **ENTER**.

When the Executing indication disappears, the laser is on.

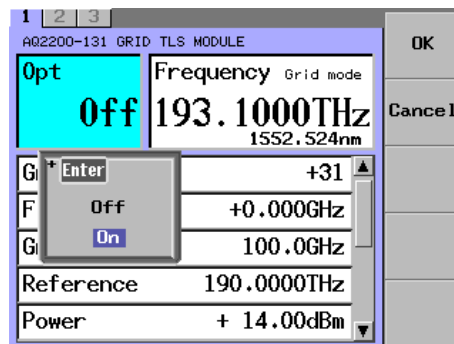

### Note

When "Lock" is displayed in the "Opt" field, the optical output cannot be generated. One of the followings is the cause:

- Interlock connector is open.
- Laser output is locked.

For details on how to generate the output, see section 2.9 "Unlocking the Laser Output" in [Startup Guide] (IM 735101-01EN).



### WARNING

Never look at the optical output connector or the top end of the optical fiber connected to the optical output connector while the laser beam is being output. The invisible laser beam cannot be seen. However, if the laser beam enters your eye(s), this may cause eye injury and the eyesight to be ruined excessively.

French



## AVERTISSEMENT

Ne jamais regarder le connecteur de sortie optique ou l'extrémité supérieure de la fibre optique raccordée au connecteur optique pendant la génération du faisceau laser. Le faisceau laser est invisible. S'il atteint l'oeil ou les yeux, il peut causer des lésions oculaires et endommager considérablement la vue.

## Setting the Frequency (Wavelength)

### Procedure

This section explains how to change the frequency (wavelength) of the laser output.

1. Press **DETAIL** to display the DETAIL screen.
2. Use the **SLOT** keys to select the Grid TLS module as the current module.
3. Press the **FREQ/WL** soft key or move the cursor using the arrow keys to Frequency (Wavelength) and press **ENTER**.

The Frequency (Wavelength) dialog box will appear.

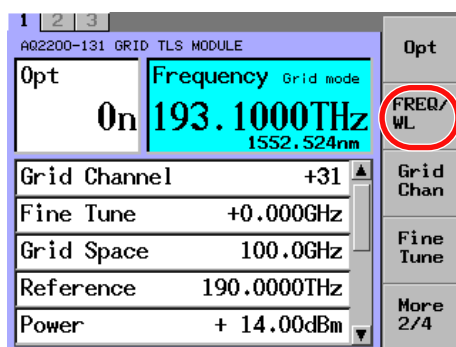

4. Use the **+Grid Space** or **-Grid Space** soft key to change the value and press the **OK** soft key or **ENTER**. You can also change the value using the numeric keypad and the arrow keys.

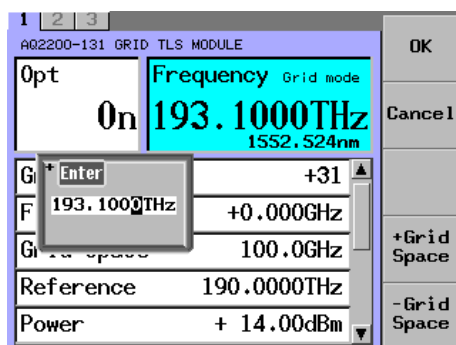

Change the frequency in steps of the specified grid spacing.

### Note

- If the displayed unit is set to THz, frequencies are displayed.
- If the displayed unit is set to nm, wavelengths are displayed.
- When the grid mode is on, the input value is rounded to the closest grid line frequency.

## 6.1 Configuring the Grid Wavelength Light Source (Grid TLS Module)

---

### Explanation

The display wavelength has the following relationship.

$$F \text{ output (THz)} = \text{Reference (THz)} + \text{Grid Space (GHz)} \times 10^{-3} \times \text{Grid channel} + \text{Fine Tune (GHz)} \times 10^{-3}$$

$$f \text{ (THz)} = F \text{ output (THz)} + \text{Freq offset (GHz)} \times 10^{-3}$$

$$\lambda \text{ (nm)} = C / (f \text{ (THz)} \times 10^3)$$

where

$\lambda$ : Display wavelength (nm)

Freq Offset: Frequency offset value (GHz)

F output: Output frequency

f: Display frequency (THz)

c: Light velocity in vacuum ( $2.99792458 \times 10^8$  m/s)

### Note

---

For details about Freq Offset, see Changing the Frequency (Wavelength) Offset (page 6-16).

---

Setting the Grid Number (When Grid Mode is On)

**Procedure**

Specify a frequency (wavelength) on the grid using a grid number.

1. Press **DETAIL** to display the DETAIL screen.
2. Use the **SLOT** keys to select the Grid TLS module as the current module.
3. Press the **Grid Chan** soft key or move the cursor using the arrow keys to Grid Channel and press **ENTER**.  
The Grid Channel dialog box will appear.

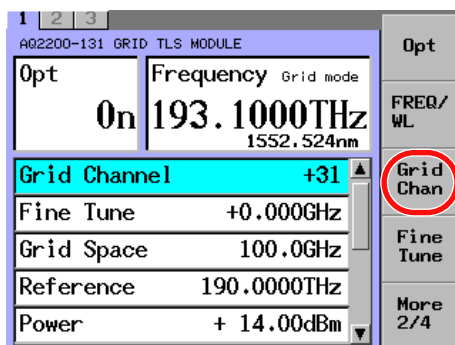

4. Change the numeric value with the numeric keypad or the arrow keys, and press the **OK** soft key or **ENTER**.

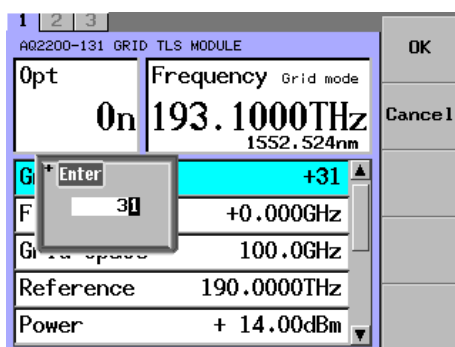

**Note**

When Grid mode is Off, the Grid Chan soft key and Grid Channel are not available.

**Explanation**

The grid assigned to the reference frequency will be channel 0. Using this channel as the reference, set the numbers for +1 (wavelength of the first grid line on the right), +2 (wavelength of the second grid line on the right), and -1 (wavelength of the first grid line on the left).

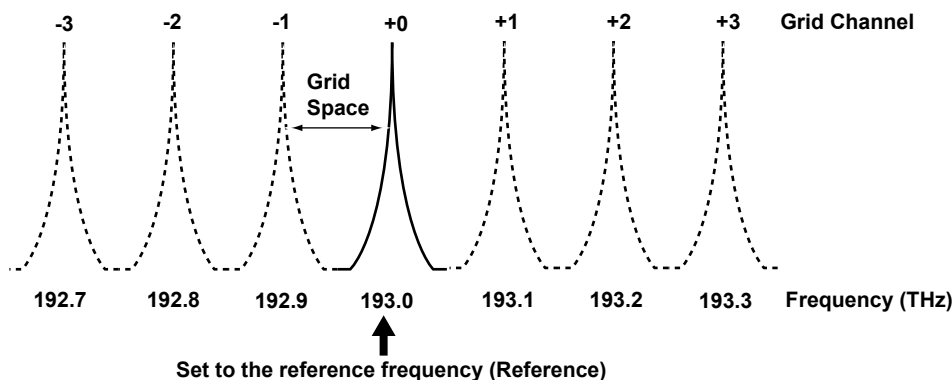

## 6.1 Configuring the Grid Wavelength Light Source (Grid TLS Module)

### Fine-Tuning the Frequency (Wavelength)

#### Procedure

You can adjust the center frequency (wavelength) of the grid in 0.001 GHz steps.

1. Press **DETAIL** to display the DETAIL screen.
2. Use the **SLOT** keys to select the Grid TLS module as the current module.
3. Press the **Fine Tune** soft key or move the cursor using the arrow keys to Fine Tune and press **ENTER**.

The Fine Tune dialog box will appear.

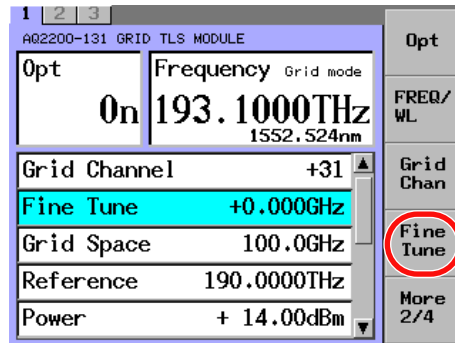

4. Change the numeric value with the numeric keypad or the arrow keys. At this time, when changing the numeric value with the arrow keys, the set value is set immediately.

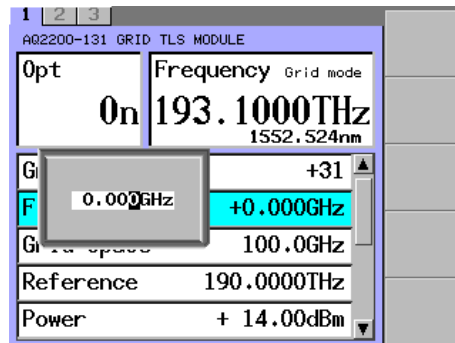

#### Note

- For suffix code -T4, Fine Tune is not available.
- Fine-tuning is not possible when the optical output is OFF.
- When you change a value with the arrow keys, the value is updated and reflected in the displayed measured values immediately.

### Setting the Frequency Spacing between Grid Lines

#### Procedure

You can set the spacing between grid lines by entering a value or by selecting from a list of fixed values.

1. Press **DETAIL** to display the DETAIL screen.
2. Use the **SLOT** keys to select the Grid TLS module as the current module.
3. Press the **Grid Space** soft key or move the cursor using the arrow keys to Grid Space and press **ENTER**.

The Grid Space dialog box will appear.

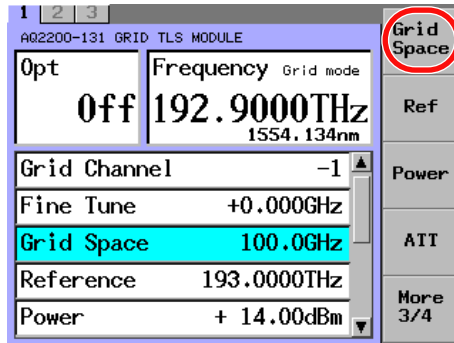

4. Use the arrow keys to select Grid Space, and press the **OK** soft key or **ENTER**. Use the arrow keys to select the spacing you want to set, and press the **OK** soft key or **ENTER**. If you select Manual, proceed to step 5.

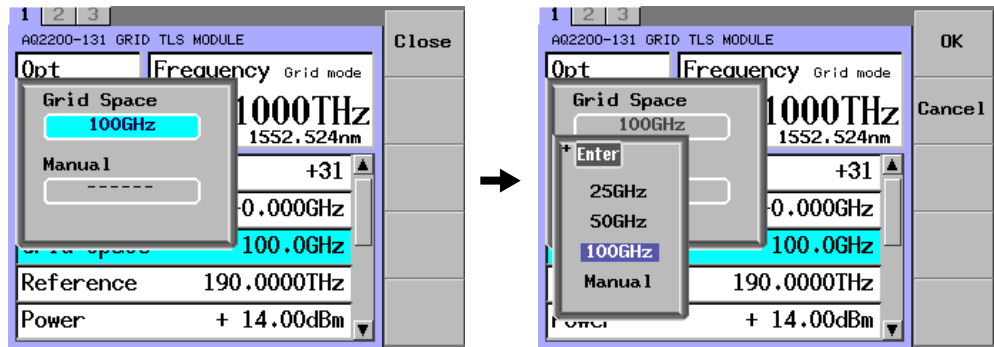

5. Move the cursor using the arrow keys to Manual and press **ENTER**. The Manual dialog box will appear.

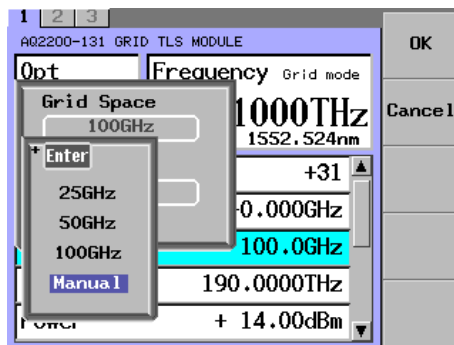



## 6.1 Configuring the Grid Wavelength Light Source (Grid TLS Module)

6. Change the numeric value with the numeric keypad or the arrow keys, and press the **OK** soft key or **ENTER**.

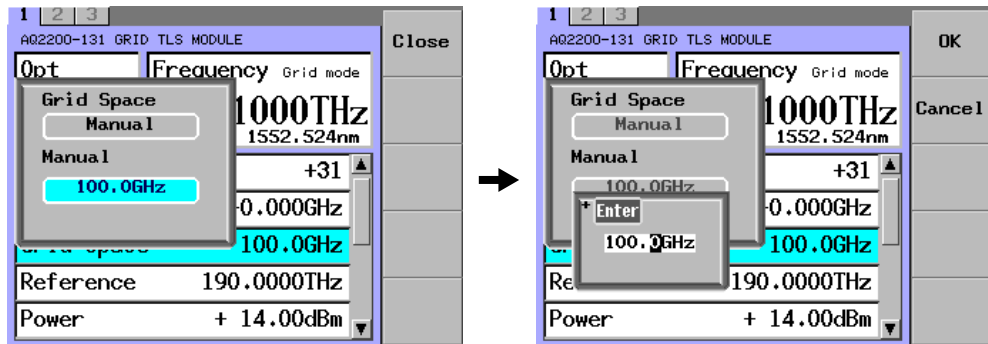

### Note

- For suffix code -T4, 25 GHz and Manual are not available.
- You cannot set the spacing when the laser output is on.

Setting the Frequency to Use as the Grid Number Reference (Channel 0)

**Procedure**

Set the frequency (reference frequency) of channel 0.

1. Press **DETAIL** to display the DETAIL screen.
2. Use the **SLOT** keys to select the Grid TLS module as the current module.
3. Press the **Ref** soft key or move the cursor using the arrow keys to Reference and press **ENTER**.

The Reference dialog box will appear.

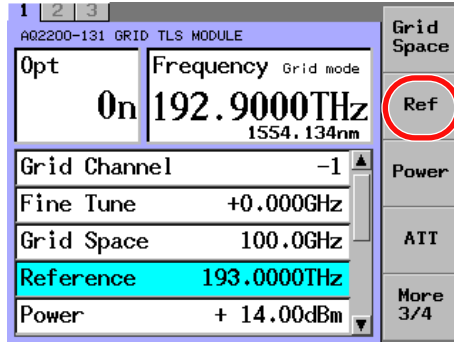

4. Use the **+Grid Space** or **-Grid Space** soft key to change the value and press the **OK** soft key or **ENTER**. You can also change the value using the numeric keypad and the arrow keys.

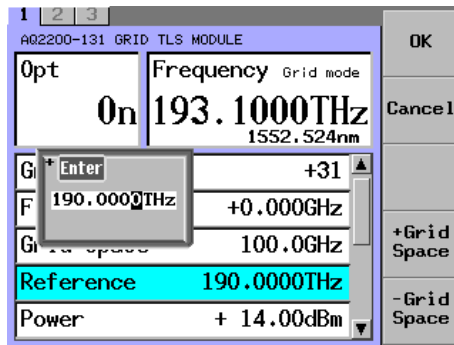

Change the frequency in steps of the specified grid spacing.

**Note**

- You cannot use the wavelength display.
- In the following situations, only grid line frequencies can be selected.
  - Suffix code -T4
  - Suffix code -T2 with frequency spacing between grid lines is not set to Manual

### Setting the Output Power Value

#### Procedure

1. Press **DETAIL** to display the DETAIL screen.
2. Use the **SLOT** keys to select the Grid TLS module as the current module.
3. Press the **Power** soft key or move the cursor using the arrow keys to Power and press **ENTER**.  
The Power dialog box will appear.

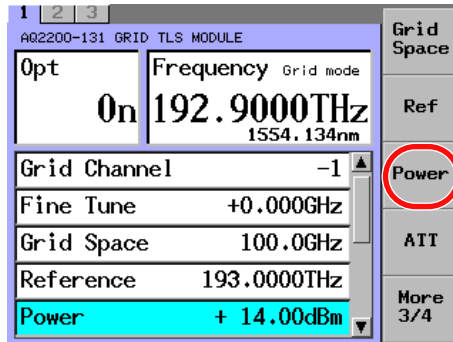

4. Change the numeric value with the numeric keypad or the arrow keys. At this time, when changing the numeric value with the arrow keys, the set value is set immediately.

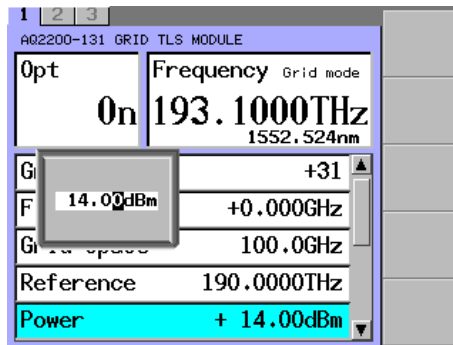

#### Note

When you change a value with the arrow keys, the value is updated and reflected in the displayed measured values immediately.

#### Explanation

With the AQ2200-131/132, you can output the laser beam by specifying an absolute power value. The following shows the relationship among the laser beam output power, attenuation amount, and power offset value.

$$PL \text{ (dBm)} = P \text{ default (dBm)} - \text{ATTN(dB)}$$

$$P \text{ display (dBm)} = PL \text{ (dBm)} + \text{PL Offset (dB)}$$

where

PL: Laser output power (dBm)

P display: Output power display value (dBm)

P default: Maximum output power at shipment (dBm)

ATTN: Attenuation amount (dB) (See Attenuating the Laser Output (next page).)

PL Offset: Power offset value (dB) (See Changing the Offset of the Display Output Power (page 6-15).)

#### Note

The connector connection status, environment, and/or secular change may affect the P default. Therefore, the values set in Pdisplay are not guaranteed. These values are used as reference.

## Setting the Output Power Attenuation

## Procedure

1. Press **DETAIL** to display the DETAIL screen.
2. Use the **SLOT** keys to select the Grid TLS module as the current module.
3. Press the **ATT** soft key or move the cursor using the arrow keys to Attenuation and press **ENTER**.

The Power dialog box will appear.

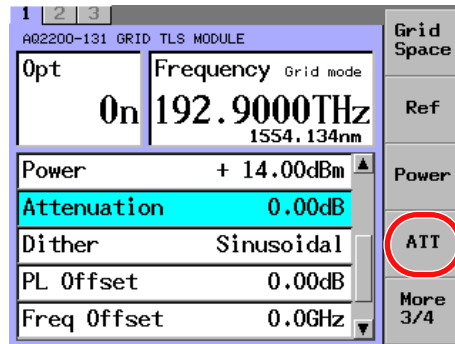

4. Change the numeric value with the numeric keypad or the arrow keys. At this time, when changing the numeric value with the arrow keys, the set value is set immediately.

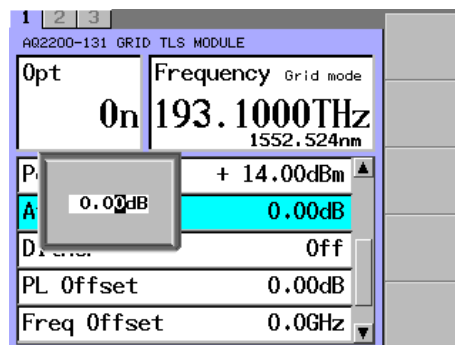
**Note**

- The range varies depending on the suffix code.  
Suffix code -T4: 0 to 4 dB  
Suffix code -T2: 0 to 6 dB
- When you change a value with the arrow keys, the value is updated and reflected in the displayed measured values immediately.

## 6.1 Configuring the Grid Wavelength Light Source (Grid TLS Module)

### Turning Dither (Laser Output Modulation) On and Off

#### Procedure

1. Press **DETAIL** to display the DETAIL screen.
2. Use the **SLOT** keys to select the Grid TLS module as the current module.
3. Press the **Dither** soft key or move the cursor using the arrow keys to Dither and press **ENTER**.

The Dither dialog box will appear.

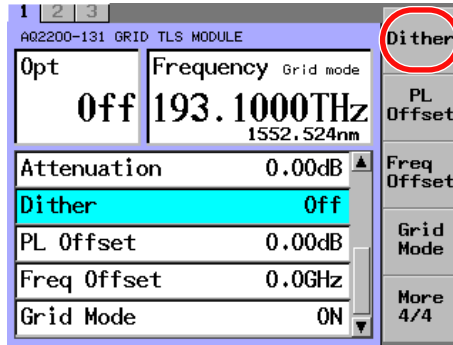

4. Use the arrow keys to select Sinusoidal or Off, and press the **OK** soft key or **ENTER**.

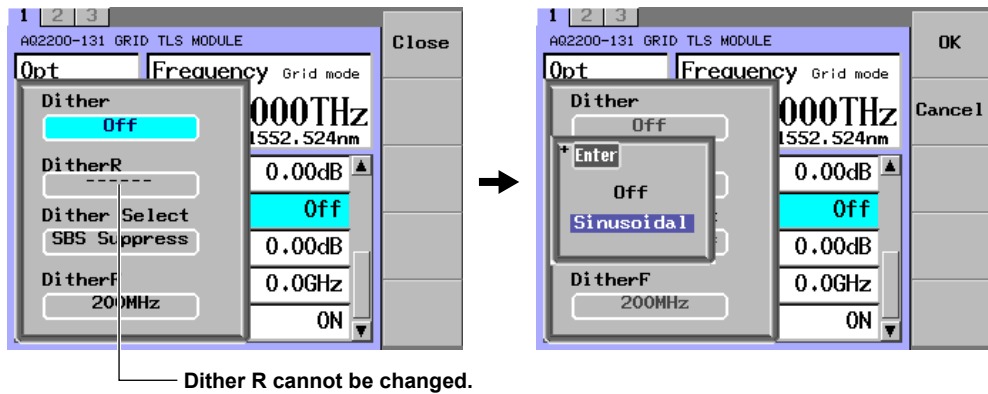

#### Note

You cannot set the spacing when the laser output is on.

#### Selecting the Dither Mode

5. Move the cursor using the arrow keys to Dither Select and press **ENTER**. The Dither Select dialog box will appear.

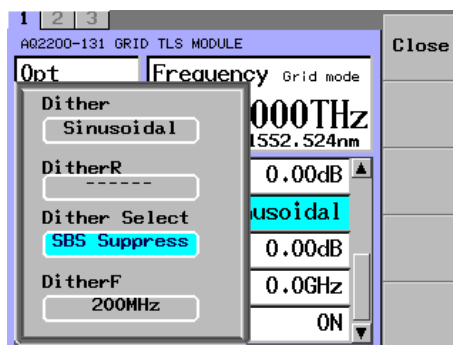

## 6.1 Configuring the Grid Wavelength Light Source (Grid TLS Module)

Use the arrow keys to select AM Tone or SBS Suppress, and press **ENTER**. If you select AM Tone, proceed to step 7.

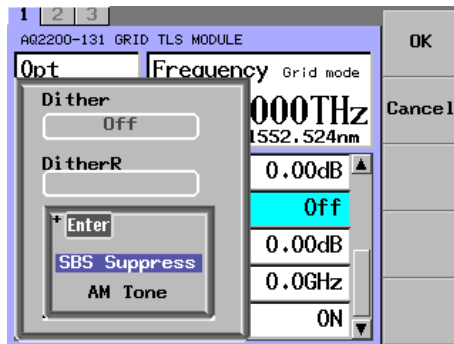

6. Move the cursor using the arrow keys to Dither F and press **ENTER**. The Dither F dialog box will appear.

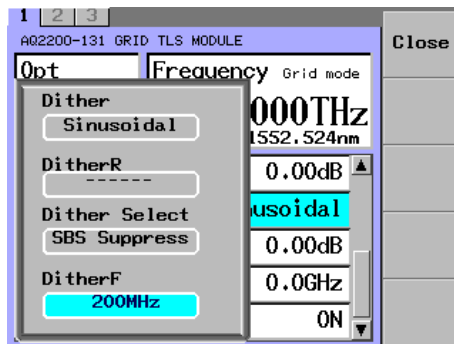

Change the numeric value with the numeric keypad or the arrow keys, and press the **OK** soft key or **ENTER**.

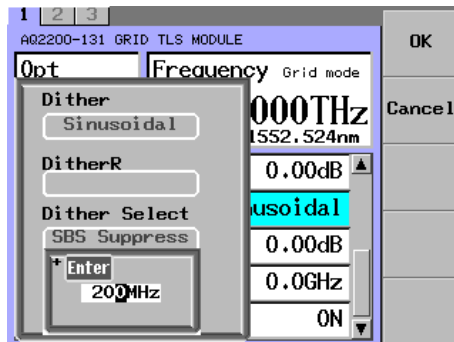

## 6.1 Configuring the Grid Wavelength Light Source (Grid TLS Module)

---

7. Move the cursor using the arrow keys to Dither A and press **ENTER**.  
The Dither A dialog box will appear.

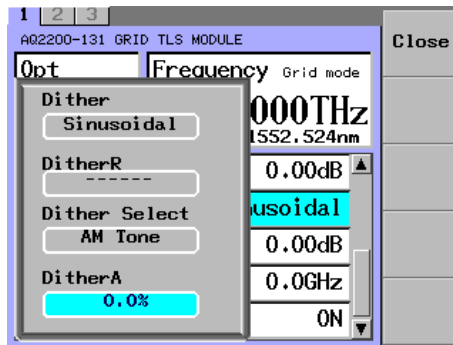

Change the numeric value with the numeric keypad or the arrow keys, and press the **OK** soft key or **ENTER**.

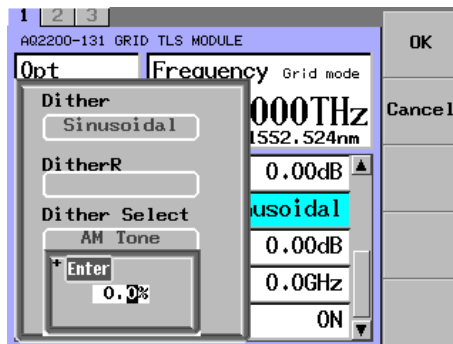

### Note

---

- Dither R cannot be changed.
  - For suffix code -T4, Dither is not available.
-

Changing the Offset of the Display Output Power

**Procedure**

You can use a value, that a power offset value (-80.00 to +80.00 dB) is added to the output power, as power display value.

1. Press **DETAIL** to display the DETAIL screen.
2. Use the **SLOT** keys to select the Grid TLS module as the current module.
3. Press the **PL Offset** soft key or move the cursor using the arrow keys to PL Offset and press **ENTER**.

The PL Offset dialog box will appear.

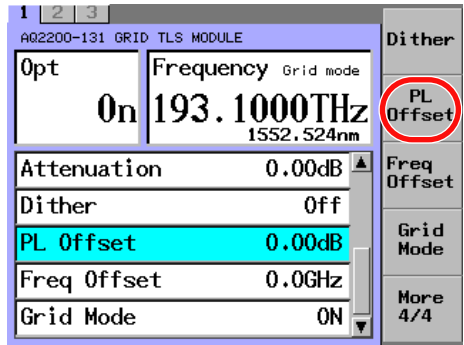

4. Change the numeric value with the numeric keypad or the arrow keys, and press the **OK** soft key or **ENTER**.

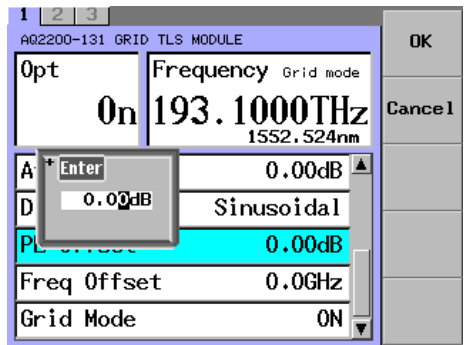

**Note**

Use the power offset to change the displayed laser output power value.  
 Even if you change the power offset value, the laser output power will not change.



### Changing the Output Frequency Offset

#### Procedure

You can display frequencies with a frequency offset value added to output frequencies.

1. Press **DETAIL** to display the DETAIL screen.
2. Use the **SLOT** keys to select the Grid TLS module as the current module.
3. Press the **Freq Offset** soft key or move the cursor using the arrow keys to Freq Offset and press **ENTER**.

The Freq Offset dialog box will appear.

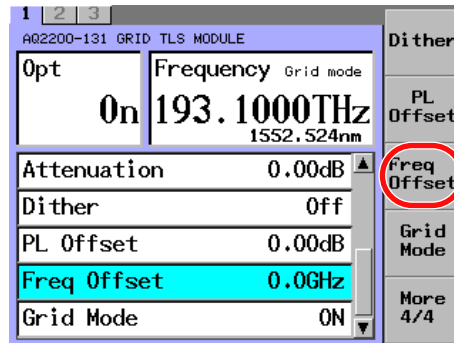

4. Change the numeric value with the numeric keypad or the arrow keys, and press the **OK** soft key or **ENTER**.

Even when the unit is nm, you must set the frequency offset in units of GHz.

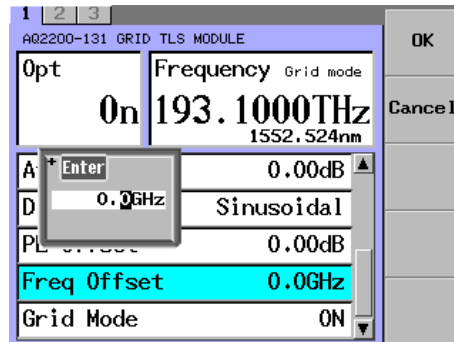

#### Note

Use the frequency offset to change the laser output frequency display value. Changing the frequency offset does not change the laser output frequency. For the relationship between the laser output frequency and frequency offset, see "Setting the Frequency (Wavelength)" on page 6-3.

## Turning the Grid Mode On and Off

## Procedure

1. Press **DETAIL** to display the DETAIL screen.
2. Use the **SLOT** keys to select the Grid TLS module as the current module.
3. Press the **Grid Mode** soft key or move the cursor using the arrow keys to Grid Mode and press **ENTER**.

The Grid Mode dialog box will appear.

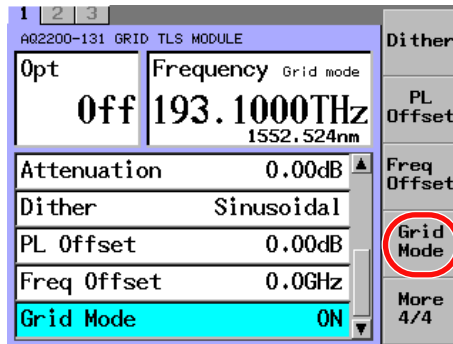

4. Use the arrow keys to select On or Off, and press the **OK** soft key or **ENTER**.

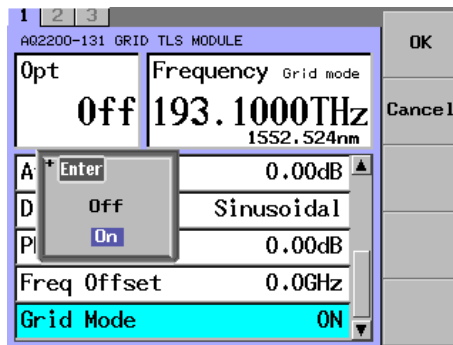
**Note**

- You cannot set the spacing when the laser output is on.
- For suffix code -T4, this feature is not available (the grid mode is fixed at ON).

## Explanation

Grid mode is a feature that rounds the specified frequency to the nearest grid line frequency.

ON: Grid mode is enabled.

OFF: The specified frequency is set. Grid Channel, Grid Space, and Reference are not available.

### Switching the Displayed Units

#### Procedure

You can switch the units that are used to display the power (dBm or W) and wavelength (nm or THz).

1. Press **DETAIL** to display the DETAIL screen.
2. Use the **SLOT** keys to select the Grid TLS module as the current module.
3. Press the **Unit** soft key.  
The Unit dialog box will appear.

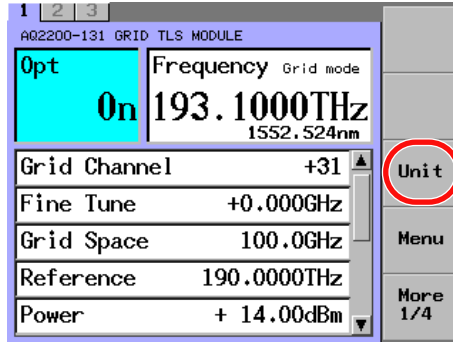

#### Changing the Power Display Unit

4. Move the cursor using the arrow keys to Power Unit and press **ENTER**.  
The dialog box for switching the displayed units will appear.

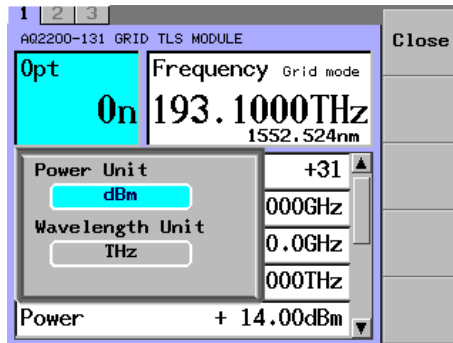

5. Move the cursor using the arrow keys to either of dBm or W and press **ENTER**.

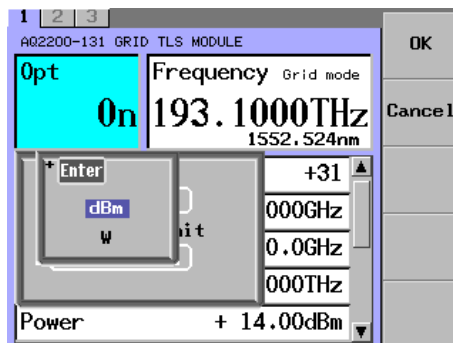

**Changing the Wavelength Display Unit**

4. Move the cursor using the arrow keys to Wavelength Unit and press **ENTER**.  
The dialog box for switching the displayed units will appear.

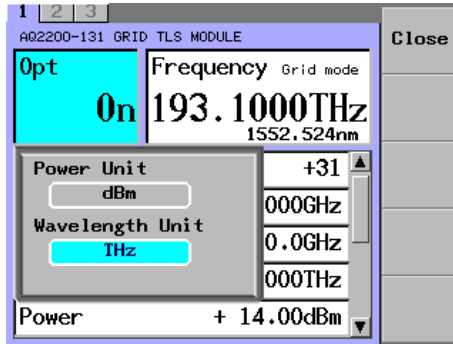

5. Move the cursor using the arrow keys to either of nm (wavelength display) or THz (frequency display) and press **ENTER**.

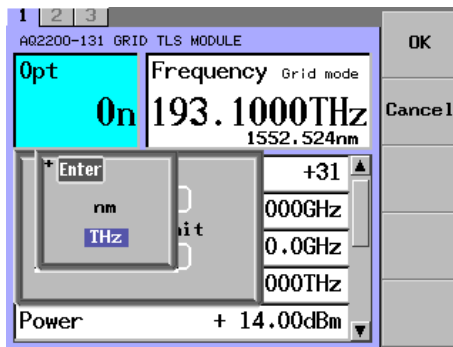

**Explanation**

**Power Display Unit**

You can switch the power display unit between the dBm display and W display. The following calculation formula shows the relationship between the dBm and W.

$$Pd\text{Bm} = 10 \log P\text{w}$$

Pw: Optical power (mW)

PdBm: Optical power (dBm)

**Wavelength Display Unit**

You can switch the display unit between the wavelength display and frequency display. The following calculation formula shows the relationship between the wavelength and frequency.

$$f \text{ (THz)} \times 10^{12} = c / (\lambda \text{ display (nm)} \times 10^{-9})$$

where

$\lambda$  display: Display wavelength (nm)

f: Display frequency (THz)

c: Light velocity in vacuum ( $2.99792458 \times 10^8$  m/s)

# 7.1 Attenuation by ATTN Module

## Turning the Optical Output On (Enable) and Off (Disable)

You can turn the optical output on and off using the shutter function. When you turn on the optical output, the module panel LED turns on.

### CAUTION

When you set optical output to ON, light resulting from attenuating the input light is transmitted. Looking straight at the output light may be hazardous; do not do so.

### French

### ATTENTION

Lorsque la sortie optique est sous tension, la lumière d'entrée atténuée est émise. Ne pas regarder directement la lumière de sortie, cela est dangereux.

## Procedure

### Setting through the Panel of the ATTN Module

- On the AQ2200-311/311A/331, press **ENABLE/DISABLE**.
- On the AQ2200-312/332, press **OUTPUT**.
- On the AQ2200-342, press **OUTPUT 1** or **OUTPUT 2**.

The on/off state of the optical output changes.

When the optical output is on, the optical output indicator (ENABLE indicator on the AQ2200-311/311A/331) or the OUTPUT key (on the AQ2200-312/332/342) lights.

### Setting through the Panel of the Frame Controller

1. Press **DETAIL** to display the DETAIL screen.
2. Use the **SLOT** keys to select the ATTN module as the current module.
3. On the AQ2200-342, use the arrow keys (◀, ▶) to select the target device.
4. Press **Output** or move the cursor using the arrow keys to Output and press **ENTER**.

The Output dialog box will appear.

#### AQ2200-311/311A/312/331/332

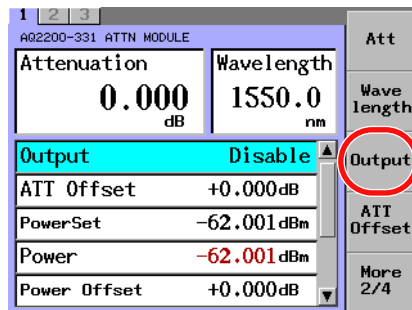

#### AQ2200-342

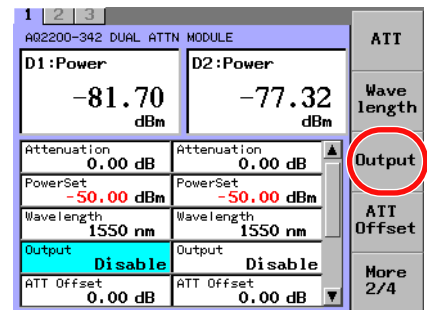

## 7.1 Attenuation by ATTN Module

---

5. Move the cursor using the arrow keys to either of Enable or Disable and press the **OK** soft key or **ENTER**.

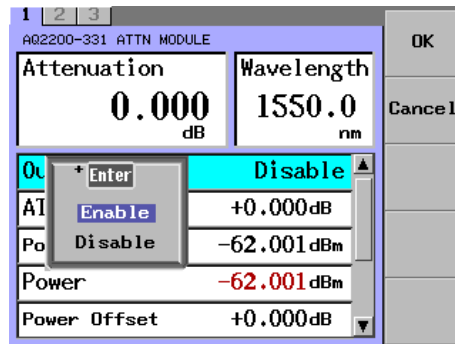

## Changing the Optical Attenuation

### Procedure

1. Press **DETAIL** to display the DETAIL screen.
2. Use the **SLOT** keys to select the ATTN module as the current module.
3. On the AQ2200-342, use the arrow keys (◀, ▶) to select the target device.
4. Press the **Att** soft key or move the cursor using the arrow keys to Attenuation and press **ENTER**.  
The Attenuation dialog box will appear.

#### AQ2200-311/311A/312/331/332

AQ2200-331 ATTN MODULE		Att
Attenuation	Wavelength	Wave length
0.000 dB	1550.0 nm	
Output	Disable	ATT Offset
ATT Offset	+0.000dB	
PowerSet	-62.001dBm	More 2/4
Power	-62.001dBm	
Power Offset	+0.000dB	

#### AQ2200-342

AQ2200-342 DUAL ATTN MODULE				ATT
D1:Power		D2:Power		Wave length
-77.75 dBm		-79.16 dBm		
Attenuation	Attenuation	ATT Offset	Output	More 2/4
0.00 dB	0.00 dB			
PowerSet	PowerSet	ATT Offset	Output	More 2/4
-50.00 dBm	-50.00 dBm			
Wavelength	Wavelength	ATT Offset	Output	More 2/4
1550 nm	1550 nm			
Output	Output	ATT Offset	Output	More 2/4
Disable	Disable			
ATT Offset	ATT Offset			
0.00 dB	0.00 dB			

5. Change the numeric value with the numeric keypad or the arrow keys, and press **ENTER**.

AQ2200-331 ATTN MODULE		Att
Attenuation	Wavelength	Wave length
0.000 dB	1550.0 nm	
Output	Enable	ATT Offset
0.000dB	+0.000dB	
PowerSet	-62.001dBm	More 2/4
Power	-62.001dBm	
Power Offset	+0.000dB	

### Note

- “Executing” may appear when you change the attenuation amount or wavelength. You cannot use the keys while “Executing” is displayed.
- If the attenuation amount is changed by a great amount on the AQ2200-342, it may take some time for the output light to stabilize.

### Explanation

In the ATTN Module, you can attenuate the laser by specifying an attenuation. The following shows the relationship between the attenuation and attenuation offset value.

$$\text{ATT (dB)} = \text{ATTdisplay (dB)} - \text{ATToffset (dB)}$$

where

ATT: Attenuation (dB) SMF: 0 to 60 dB, 0.001dB step  
0 to 40 dB, 0.01dB step (AQ2200-342)  
MMF: 0 to 45 dB, 0.001dB step

ATTdisplay: Attenuation display value (dBm)

ATToffset: Attenuation offset value (dB) (See “Changing the Attenuation Offset Value” (page 7-5).

## Changing the Wavelength

### Procedure

1. Press **DETAIL** to display the DETAIL screen.
2. Use the **SLOT** keys to select the ATTN module as the current module.
3. On the AQ2200-342, use the arrow keys (◀, ▶) to select the target device.
4. Press the **Wavelength** soft key or move the cursor using the arrow keys to Wavelength and press **ENTER**.  
The Wavelength dialog box will appear.

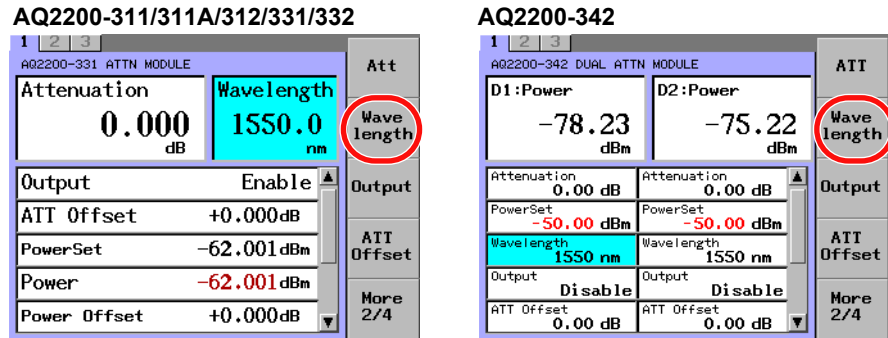

5. Change the numeric value with the numeric keypad or the arrow keys, and press the **OK** soft key or **ENTER**.

To specify a typical wavelength, press the **Typical** soft key.  
The typical wavelength switches each time you press the key.

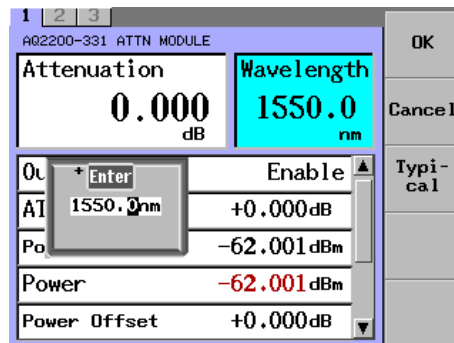

### Note

The typical wavelengths that you can choose from are 850 nm, 1300 nm, 1310 nm, and 1550 nm. The typical wavelengths that can be set vary depending on the module.

On ATTN modules that support SMF, you can select 1300 nm, 1310 nm or 1550 nm.

On ATTN modules that support MMF, you can select 850, 1300 nm, or 1310 nm.

### Explanation

In the ATTN Module, you can set a more accurate attenuation by specifying a wavelength

For ATTN module applicable to SMF

Minimum settable wavelength: 1200.0 nm, 1260 nm (AQ2200-342)

Maximum settable wavelength: 1700.0 nm, 1640 nm (AQ2200-342)

For ATTN module applicable to MMF

Minimum settable wavelength: 800.0 nm

Maximum settable wavelength: 1370.0 nm



## Changing the Attenuation Offset Value

A value, that an attenuation offset value (-200.000 to +200.000 dB) is added to the attenuation, is used as attenuation display value.

### Procedure

1. Press **DETAIL** to display the DETAIL screen.
2. Use the **SLOT** keys to select the ATTN module as the current module.
3. On the AQ2200-342, use the arrow keys (◀, ▶) to select the target device.
4. Press the **ATT Offset** soft key or move the cursor using the arrow keys to Att Offset and press **ENTER**.  
The Att Offset dialog box will appear.

#### AQ2200-311/311A/312/331/332

AQ2200-331 ATTN MODULE		Att
Attenuation	Wavelength	Wave length
0.000 dB	1550.0 nm	
Output	Enable	Output
ATT Offset	+0.000dB	ATT Offset
PowerSet	-62.001dBm	More 2/4
Power	-62.001dBm	
Power Offset	+0.000dB	

#### AQ2200-342

AQ2200-342 DUAL ATTN MODULE				ATT
D1:Power	D2:Power			Wave length
-79.21 dBm	-78.04 dBm			
Attenuation	Attenuation			Output
0.00 dB	0.00 dB			ATT Offset
PowerSet	PowerSet			More 2/4
-50.00 dBm	-50.00 dBm			
Wavelength	Wavelength			
1550 nm	1550 nm			
Output	Output			
Disable	Disable			
ATT Offset	ATT Offset			
0.00 dB	0.00 dB			

5. Change the numeric value with the numeric keypad or the arrow keys, and press the **OK** soft key or **ENTER**.

AQ2200-331 ATTN MODULE		OK
Attenuation	Wavelength	Cancel
0.000 dB	1550.0 nm	
Output	Enable	
ATT Offset	+0.000dB	
PowerSet	-62.001dBm	
Power	-62.001dBm	
Power Offset	+0.000dB	

## Sets the Currently Displayed Attenuation Value to the Attenuation Offset Value (AQ2200-331/332/342)

1. Press the **D->Aoffs** soft key, and the value displayed in the Attenuation field changes to the attenuation offset value and it is displayed in the ATT Offset field.

#### AQ2200-331/332

AQ2200-331 ATTN MODULE		D->Aoffs
Attenuation	Wavelength	Output Start
0.000 dB	1550.0 nm	
Output	Enable	Pset
ATT Offset	+0.000dB	Unit
PowerSet	-62.001dBm	More 3/4
Power	-62.001dBm	
Power Offset	+0.000dB	

#### AQ2200-342

AQ2200-342 DUAL ATTN MODULE				D->Aoffs
D1:Power	D2:Power			Output Start
-80.85 dBm	-77.98 dBm			
Attenuation	Attenuation			Pset
0.00 dB	0.00 dB			APC
PowerSet	PowerSet			More 3/4
-50.00 dBm	-50.00 dBm			
Wavelength	Wavelength			
1550 nm	1550 nm			
Output	Output			
Disable	Disable			
ATT Offset	ATT Offset			
0.00 dB	0.00 dB			

### Turning the Optical Output On (Enable) and Off (Disable) When the Power Is Turned On

You can set the optical output to turn on or off when the frame controller is turned on. If the optical output is on, the LED on the module panel or the OUTPUT key (AQ2200-312/332/342) lights.

#### CAUTION

When the optical output is on, light resulting from attenuating the input light is transmitted. Looking straight at the output light may be hazardous; do not do so.

#### French

#### ATTENTION

Lorsque la sortie optique est sous tension, la lumière d'entrée atténuée est émise. Ne pas regarder directement la lumière de sortie, cela est dangereux.

### Procedure

1. Press **DETAIL** to display the DETAIL screen.
2. Use the **SLOT** keys to select the ATTN module as the current module.
3. On the AQ2200-342, use the arrow keys (◀, ▶) to select the target device.
4. Press the **Output Start** soft key to display the Output Start dialog box.

**AQ2200-311/311A/312/331/332**

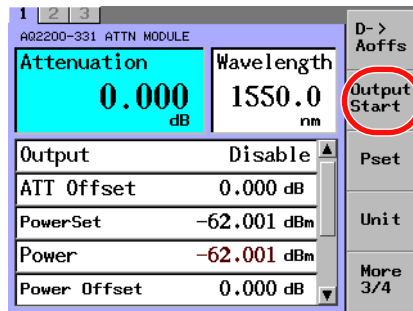

**AQ2200-342**

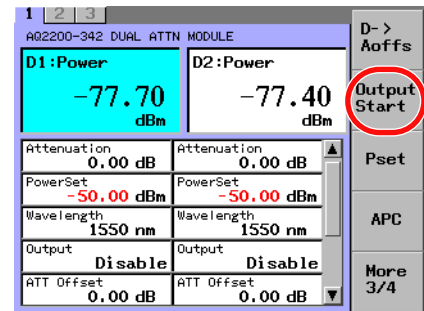

5. Use the arrow keys to move the cursor to StartUp Enable or StartUp Disable, and press the **OK** soft key or **ENTER**.

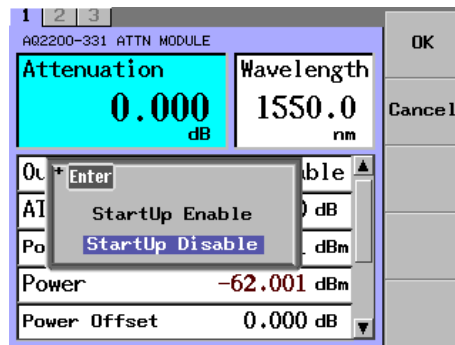

## 7.2 Attenuation Using an ATTN Module with a Built-in Monitor Power Meter

This section describes how to operate the attenuation module with a built-in monitor power meter.

### Displaying the Current Optical Output Monitor Value

You can display the current optical output monitor value.

This optical output monitor value includes the offset value.

Optical output monitor value = Actual output monitor value + Offset value

Optical output monitor value: Display monitor value (dBm or W)

Actual output monitor value: Value when the offset set value is "0" (dBm or W).

#### AQ2200-331/332

1 2 3		Disp Reso
AQ2200-331 ATTN MODULE		Disp Mode
Attenuation	Wavelength	Menu
0.000 dB	1550.0 nm	
Output	Enable	More 1/4
ATT Offset	+0.000 dB	
PowerSet +offs	-61.001 dBm	
Power +offs	-61.001 dBm	
Power Offset	+1.000 dB	

Power = Actual output monitor value + Power Offset

#### AQ2200-342

1 2 3		D- > Aoffs
AQ2200-342 DUK - ATTN MODULE		Output Start
D1:Power	D2:Power	Pset
-77.70 dBm	-77.40 dBm	
Attenuation	Attenuation	APC
0.00 dB	0.00 dB	
PowerSet	PowerSet	More 3/4
-50.00 dBm	-50.00 dBm	
Wavelength	Wavelength	
1550 nm	1550 nm	
Output	Output	
Disable	Disable	
ATT Offset	ATT Offset	
0.00 dB	0.00 dB	

Power = Actual output monitor value + Power Offset

### Starting the ZERO-SET

When performing the ZERO-SET, the electrical offset inside the monitor power meter is adjusted, allowing you to accurately measure the absolute value. Two kinds of ZERO-SET modes are provided as described below.

Select a desired mode to execute the ZERO-SET corresponding to your need.

- Zero: Starts the ZERO-SET of the current module.
- Zero ALL: Starts the ZERO-SET of all mounted sensor modules and the AQ2200-331/332/342 ATTN modules.

### Procedure

1. Attach light shielding caps to the selected ATTN module with a built-in monitor power meter and to the optical inputs of all of the sensors that you intend to perform zero-set on.
2. Press **DETAIL** to display the DETAIL screen.
3. Use the **SLOT** keys to select the ATTN module as the current module.
4. On the AQ2200-342, use the arrow keys (◀, ▶) to select the target device.
5. Press either the **Zero** or **Zero ALL** soft key to start the ZERO-SET.  
When the ZERO-SET is completed, the screen is returned to the previous screen.

**AQ2200-331/332**

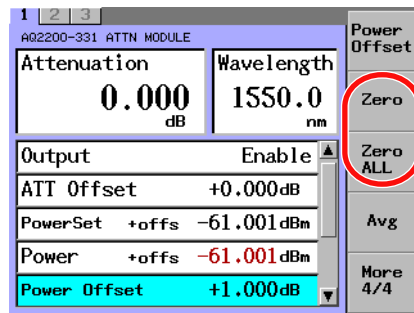

**AQ2200-342**

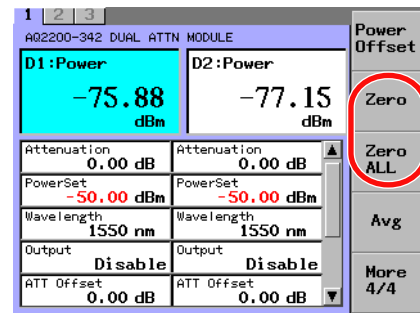

### Note

- If ZERO-SET is executed without attaching the light shield cap to the optical receiving connector and to the optical inputs of the sensors, the effects from the minimal amount of light that enters may hinder correct ZERO-SET.
- While the ZERO-SET is being executed, the shutter function operates. Thus, even when the optical output is set to ON, optical output is automatically blocked.

### Changing the Optical Output Set Value

The optical attenuation is adjusted automatically so that the set optical output value is obtained. This optical output value includes the power offset value.

$$P \text{ (dBm)} = Pset \text{ (dBm)} - Poffset \text{ (dB)}$$

where

P: Laser output power (dBm)

Pset: Output set value (dBm)

Setting range AQ2200-331/332: -50 dBm to +19 dBm (0.001 dB step)

AQ2200-342: -50 dBm to +20 dBm (0.01 dB step)

Poffse: Power offset value (dB)

### Procedure

1. Press **DETAIL** to display the DETAIL screen.
2. Use the **SLOT** keys to select the ATTN module as the current module.
3. On the AQ2200-342, use the arrow keys (◀, ▶) to select the target device.
4. Press the **P set** soft key or move the cursor using the arrow keys to Power Set and press **ENTER**.

The Power Set dialog box will appear.

**AQ2200-331/332**

AQ2200-331 ATTN MODULE		D- > Aoffs
Attenuation	Wavelength	Output Start
0.000 dB	1550.0 nm	
Output	Enable	Pset
ATT Offset	+0.000dB	
PowerSet	-62.001dBm	Unit
Power	-62.001dBm	
Power Offset	+0.000dB	More 3/4

**AQ2200-342**

AQ2200-342 DUAL ATTN MODULE				D- > Aoffs
D1:Power		D2:Power		Output Start
-74.59 dBm		-81.30 dBm		
Attenuation	Attenuation	Pset	APC	More 3/4
0.00 dB	0.00 dB			
PowerSet	PowerSet	Unit	APC	More 3/4
-50.00 dBm	-50.00 dBm			
Wavelength	Wavelength	Unit	APC	More 3/4
1550 nm	1550 nm			
Output	Output	Unit	APC	More 3/4
Disable	Disable			
ATT Offset	ATT Offset	Unit	APC	More 3/4
0.00 dB	0.00 dB			

5. Change the numeric value with the numeric keypad or the arrow keys, and press the **OK** soft key or **ENTER**.

AQ2200-331 ATTN MODULE		OK
Attenuation	Wavelength	Cancel
0.000 dB	1550.0 nm	
Output	Enable	OK
ATT Offset	+0.000dB	
PowerSet	-62.001dBm	OK
Power	-62.001dBm	
Power Offset	+0.000dB	OK

## 7.2 Attenuation Using an ATTN Module with a Built-in Monitor Power Meter

---

### **Note**

- When the output light is adjusted to the set value, the optical attenuation amount is held at a constant value. Even if the input optical power changes, the optical attenuation amount will not change.
  - After setting the optical output set value, the value may appear in red. This signifies that the output optical power cannot be adjusted to the set value for the input optical power. Reenter an appropriate value.
  - The AQ2200-342 has an APC (auto power control) function that holds the output optical power constant by automatically adjusting the optical attenuation amount according to the changes in the input optical power. For details, see page 7-16.
  - “Executing” may appear when you change the optical output set value. You cannot use the keys while “Executing” is displayed.
  - If the optical output set value is changed by a great amount on the AQ2200-342, the output value may stray from the set value. If this happens, set the optical output set value again, or use the above-mentioned APC (auto power control) function.
-

### Setting a Power Offset Value

You can use a value, that a power offset value (-200.000 to +200.000 dB) is added to the optical output set value or optical output monitor value, as the output power display value.

#### Procedure

1. Press **DETAIL** to display the DETAIL screen.
2. Use the **SLOT** keys to select the ATTN module as the current module.
3. On the AQ2200-342, use the arrow keys (◀, ▶) to select the target device.
4. Press the **Power Offset** soft key or move the cursor using the arrow keys to Power Offset and press **ENTER**.  
The Power Offset dialog box will appear.

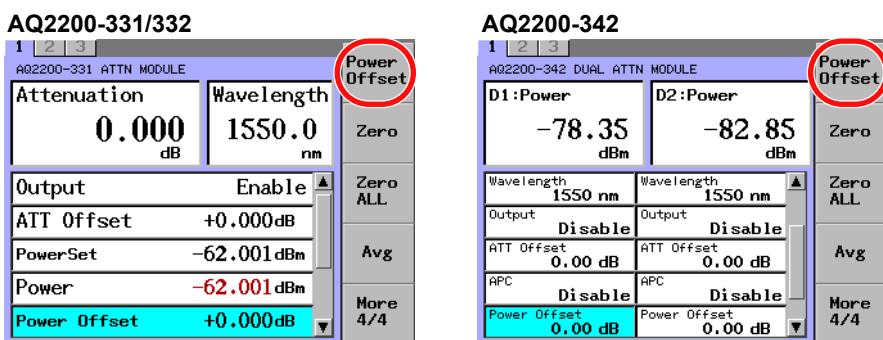

5. Change the numeric value with the numeric keypad or the arrow keys, and press the **OK** soft key or **ENTER**.

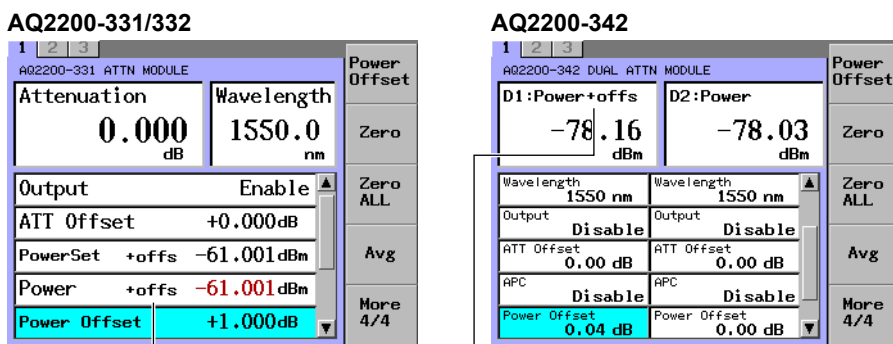
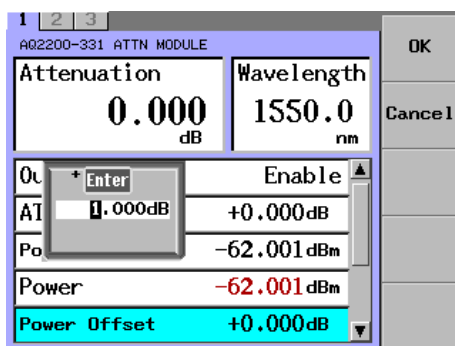

When the power offset is set, "+offs" is shown.

### Setting a Display Resolution of Each Set Value

#### Procedure

1. Press **DETAIL** to display the DETAIL screen.
2. Use the **SLOT** keys to select the ATTN module as the current module.
3. On the AQ2200-342, use the arrow keys (◀, ▶) to select the target device.
4. On the AQ2200-331/332, press the **Disp Reso** soft key or move the cursor using the arrow keys to Disp Reso and press **ENTER**.  
The Disp Reso dialog box will appear.  
On the AQ2200-342, move the cursor using the arrow keys to Power, and press **ENTER**.  
A dialog box for setting the power display digits will appear.

**AQ2200-331/332**

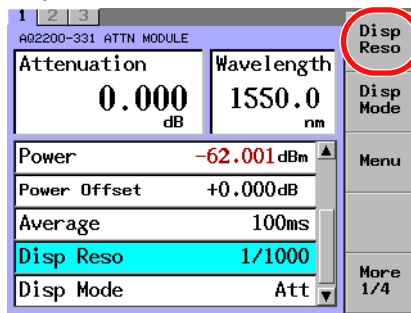

**AQ2200-342**

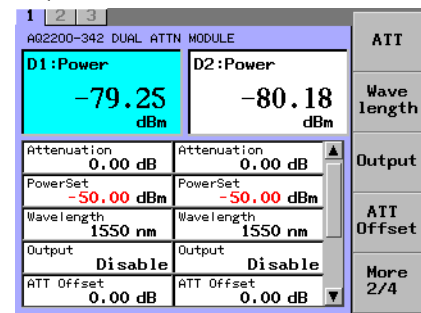

5. Move the cursor to a desired decimal place with the arrow keys, and press the **OK** soft key or **ENTER**.

**AQ2200-331/332**

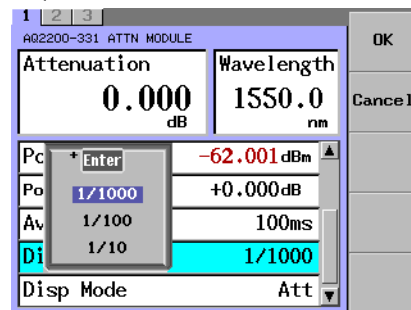

**AQ2200-342**

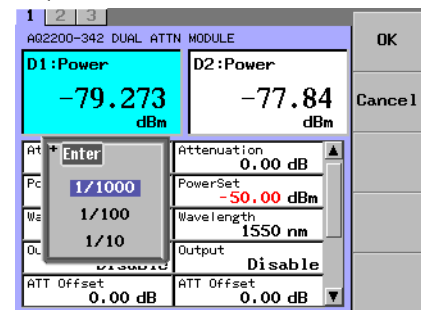

#### Explanation

You can display each parameter at a decimal place of 1/10, 1/100, or 1/1000. Select a necessary decimal place. Note that the value at the least significant decimal place is made by rounding the value at the most significant decimal place that is not displayed. For units of W, the decimal point can move within the five valid number of digits, therefore there are times when the actual displayed digits are not the same as the specified digits.

#### Applicable Parameters

AQ2200-331/332	AQ2200-342
Attenuation	Power
Att Offset	Max Power
Power	Min Power
Power Offset	
Power Set	



### Changing the Power Display Unit

The display unit of the optical output set value (PowerSet) and the optical output monitor value "Power" is changed to "dBm" or "W".

#### Procedure

1. Press **DETAIL** to display the DETAIL screen.
2. Use the **SLOT** keys to select the ATTN module as the current module.
3. On the AQ2200-342, use the arrow keys (◀, ▶) to select the target device.
4. Press the **Unit** soft key.  
The Unit dialog box will appear.

**AQ2200-331/332**

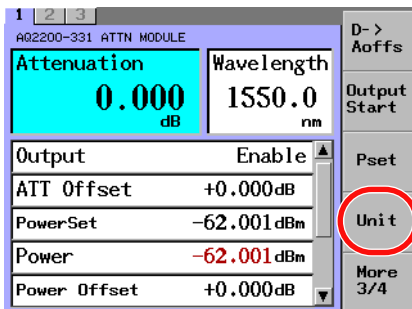

**AQ2200-342**

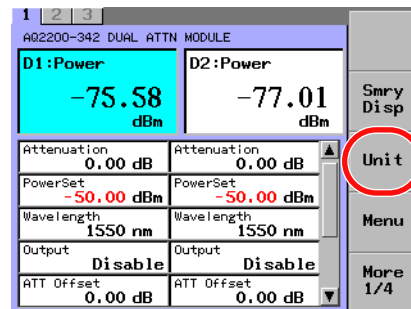

5. Move the cursor using the arrow keys to either of dBm or W and press the **OK** soft key or **ENTER**.

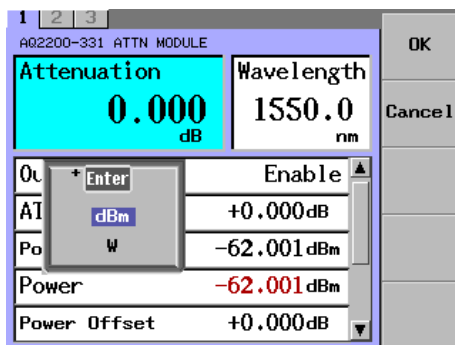

## 7.2 Attenuation Using an ATTN Module with a Built-in Monitor Power Meter

### Setting an Averaging Time

Time data you have set here is averaged and it is used as one measurement data.

#### Procedure

1. Press **DETAIL** to display the DETAIL screen.
2. Use the **SLOT** keys to select the ATTN module as the current module.
3. On the AQ2200-342, use the arrow keys (◀, ▶) to select the target device.
4. Press the **Avg** soft key or move the cursor using the arrow keys to Average and press **ENTER**.

The Average dialog box will appear.

**AQ2200-331/332**

AQ2200-331 ATTN MODULE		Power Offset
Attenuation	Wavelength	Zero
0.000 dB	1550.0 nm	Zero
Power	-62.001 dBm	Zero ALL
Power Offset	+0.000 dB	<b>Avg</b>
Average	100ms	More 4/4
Disp Reso	1/1000	
Disp Mode	Att	

**AQ2200-342**

AQ2200-342 DUAL ATTN MODULE				Power Offset
D1:Power		D2:Power		Zero
-78.04 dBm		-74.51 dBm		Zero
Output	Disable	Output	Disable	Zero ALL
ATT Offset	0.00 dB	ATT Offset	0.00 dB	<b>Avg</b>
APC	Disable	APC	Disable	More 4/4
Power Offset	0.00 dB	Power Offset	0.00 dB	
Average	100ms	Average	100ms	

5. Move the cursor to a desired average time with the arrow keys, and press the **OK** soft key or **ENTER**.

AQ2200-331 ATTN MODULE		OK
Attenuation	Wavelength	Cancel
0.000 dB	1550.0 nm	
Power	-62.001 dBm	
Power Offset	+0.000 dB	
Average	100ms	
Disp Reso	1/1000	
Disp Mode	Att	

### Setting the Items to Display on the SUMMARY Screen

Set the items to display on the SUMMARY screen.

On the AQ2200-331/332, select the attenuation amount or optical output set value. The wavelength is fixed.

On the AQ2200-342, select the attenuation amount, optical output set value, or optical output value.

#### Procedure

1. Press **DETAIL** to display the DETAIL screen.
2. Use the **SLOT** keys to select the ATTN module as the current module.
3. On the AQ2200-342, use the arrow keys (◀, ▶) to select the target device.
4. On the AQ2200-331, press the **Disp Mode** soft key or move the cursor using the arrow keys to Disp Mode and press **ENTER**.

On the AQ2200-342, press the **Smry Disp** soft key.

The Disp Mode or Smry Disp dialog box will appear.

**AQ2200-331/332**

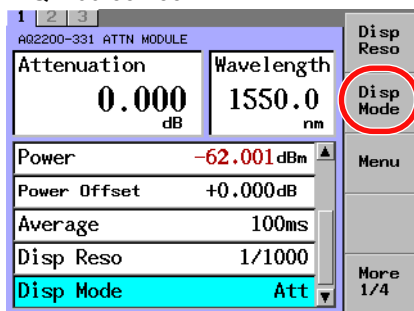

**AQ2200-342**

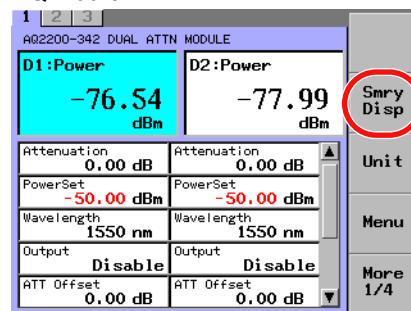

5. On the AQ2200-331/332, move the cursor using the arrow keys to ATT or Pset (ATT, Pset, or PMonitor on the AQ2200-342), and press the **OK** soft key or **ENTER**.

**AQ2200-331/332**

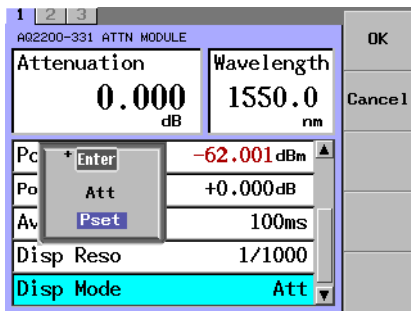

**AQ2200-342**

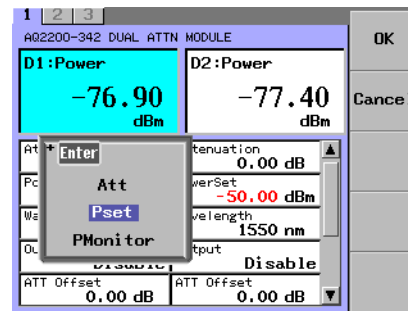

#### Explanation

On the AQ2200-331/332, the selected item is shown in the largest display area at the top of the DETAIL screen and also on the SUMMARY screen.

On the AQ2200-342, the DETAIL screen does not change. This applies only to the SUMMARY screen.

### Holding the Optical Output Power Constant by Automatically Adjusting the Attenuation Amount according to the Changes in the Input Optical Power (AQ2200-342)

This section explains the function that adjusts the output optical power to the set Pset value by automatically adjusting the attenuation amount according to the changes in the input light.

#### Procedure

1. Press **DETAIL** to display the DETAIL screen.
2. Use the **SLOT** keys to select the ATTN module as the current module.
3. Use the arrow keys (**◀**, **▶**) to select the target device.
4. Press the **APC** soft key or move the cursor using the arrow keys to APC and press **ENTER**.

The APC dialog box will appear.

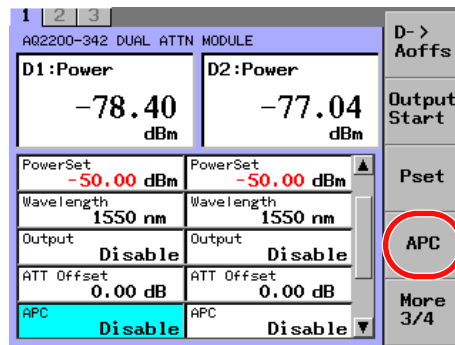

5. Move the cursor using the arrow keys to Enable or Disable, and press the **OK** soft key or **ENTER**.

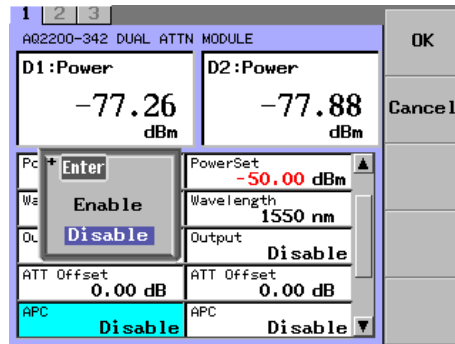

#### Note

- If APC is set to Enable, the attenuation amount will be automatically adjusted so that the optical output power is held at the Pset value.
- If APC is set to Disable, the current attenuation amount is held.
- "Executing" may appear when you set APC to Enable. You cannot use the keys while "Executing" is displayed.
- If the output optical power cannot be adjusted to the Pset value, the Pset value will appear in red.
- If you set the attenuation amount (Attenuation), APC will be automatically disabled.
- If the input light is blocked and then it recovers while the optical output power is being adjusted, the attenuation amount is temporarily set to 0 dB. When this happens, be careful because light will be output at a level higher than the set Pset value.

## Holding the Maximum or Minimum Optical Output Monitor Value (AQ2200-342)

## Procedure

1. Press **DETAIL** to display the DETAIL screen.
2. Use the **SLOT** keys to select the ATTN module as the current module.
3. Use the arrow keys (◀, ▶) to select the target device.
4. Press the **MaxMin Mode** soft key or move the cursor using the arrow keys to Max Power or Min Power and press **ENTER**.  
The MaxMin Mode dialog box will appear.

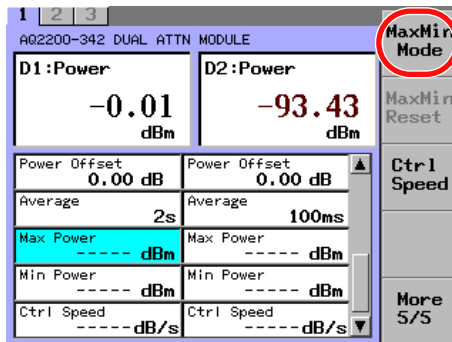

5. Move the cursor using the arrow keys to Continuous or Off, and press the **OK** soft key or **ENTER**.

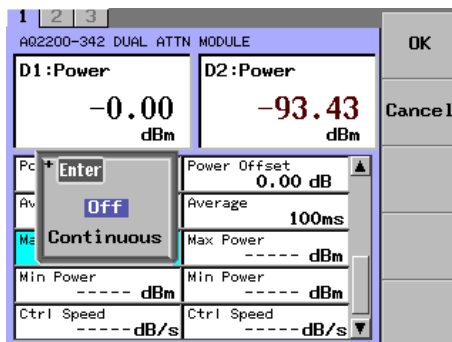

## Clearing the Max or Min Value during Measurement

Press the **MaxMin Reset** soft key to clear the Max Power and Min Power values and restart the measurement.

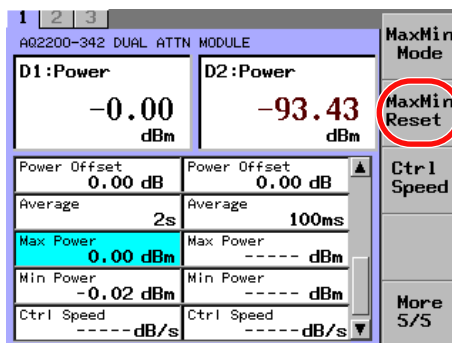

## 7.2 Attenuation Using an ATTN Module with a Built-in Monitor Power Meter

### Note

- When the MaxMin Mode is set to Continuous, setting Continuous again will result in the same operation as when the MaxMin Reset soft key is pressed.
- Max and Min values include the power offset value.
- The Max and Min unit is displayed according to the Unit setting.
- The number of digits is according to the display resolution setting.

### Explanation

#### Maximum and Minimum Measurement

If you set MaxMin Mode to Continuous, the maximum and minimum values will be updated every time the measured value is updated from when the mode is set until the mode is changed to Off.

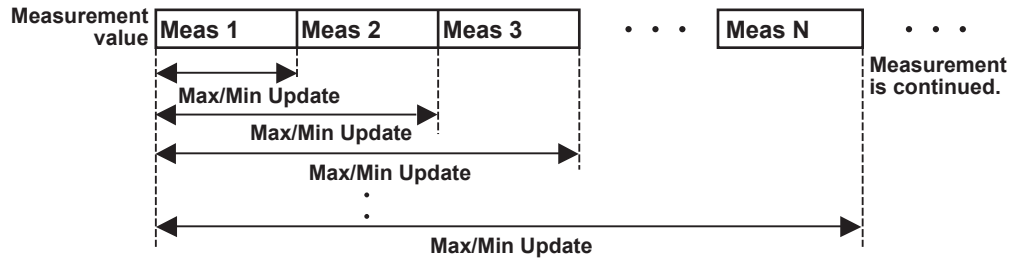

## Setting the Attenuation Speed When an Attenuation Amount Is Specified (AQ2200-342)

Set the speed for reaching the specified attenuation amount.

### Procedure

1. Press **DETAIL** to display the DETAIL screen.
2. Use the **SLOT** keys to select the ATTN module as the current module.
3. Use the arrow keys (**◀**, **▶**) to select the target device.
4. Press the **Ctrl Speed** soft key or move the cursor using the arrow keys to Ctrl Speed and press **ENTER**.

The Ctrl Speed dialog box will appear.

1   2   3		MaxMin Mode
AQ2200-342 DUAL ATTN MODULE		MaxMin Reset
D1:Power -0.00 dBm	D2:Power -93.43 dBm	Ctrl Speed
Power Offset 0.00 dB	Power Offset 0.00 dB	
Average 2s	Average 100ms	More 5/5
Max Power ----- dBm	Max Power ----- dBm	
Min Power ----- dBm	Min Power ----- dBm	
Ctrl Speed ----- dB/s	Ctrl Speed ----- dB/s	

5. Change the value using the numeric keypad or the arrow keys, and press the **OK** soft key or **ENTER**.

1   2   3		OK
AQ2200-342 DUAL ATTN MODULE		Cancel
D1:Power -0.00 dBm	D2:Power -93.43 dBm	Max
Power Offset 0.00 dB	Power Offset 0.00 dB	
Average 2s	Average 100ms	
Max Power ----- dBm	Max Power ----- dBm	
Min Power ----- dBm	Min Power ----- dBm	
Ctrl Speed 80.00 dB/s	Ctrl Speed ----- dB/s	

### Note

While attenuating at the specified speed, Executing will be displayed.

### Clearing the Attenuation Speed (Maximizing the Speed)

Press the **Max** soft key to clear the Ctrl Speed value and set the maximum speed.

1   2   3		OK
AQ2200-342 DUAL ATTN MODULE		Cancel
D1:Power -0.00 dBm	D2:Power -93.43 dBm	Max
Power Offset 0.00 dB	Power Offset 0.00 dB	
Average 2s	Average 100ms	
Max Power ----- dBm	Max Power ----- dBm	
Min Power ----- dBm	Min Power ----- dBm	
Ctrl Speed ----- dB/s	Ctrl Speed ----- dB/s	

**Explanation**

**Attenuation speed**

• **When an Attenuation Amount Is Set (ATT)**

If the attenuation amount is changed from ATT0 to ATT1, the value is set at the specified attenuation speed.

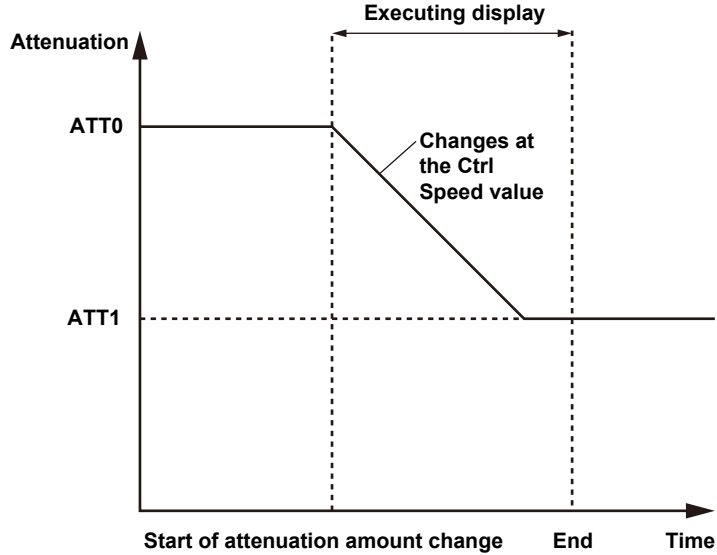

• **When Output Power Is Set (Pset) or during Automatic Output Adjustment (APC)**

If the output power value is changed from the current value (Power0) to Pset value (Power1) or if APC is enabled and the output power value is changed from the current value (Power0) to Pset value (Power1), the output power value is set at the specified attenuation speed.

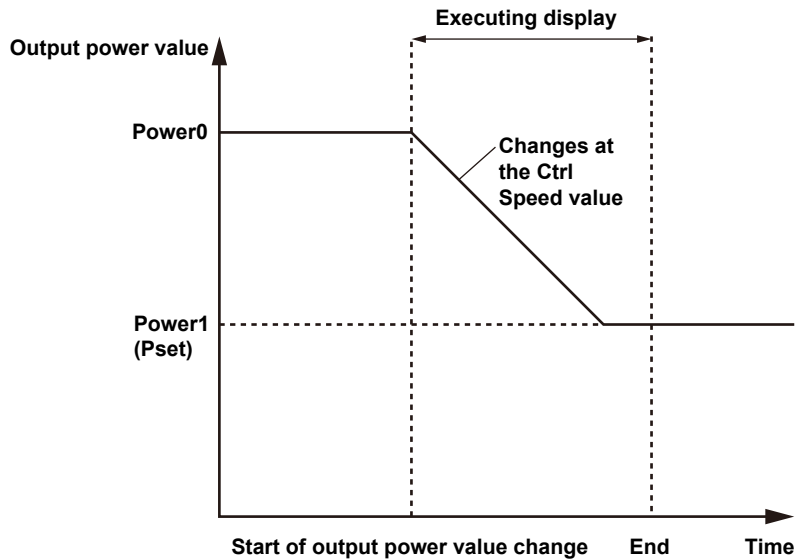

**Note**

When changing from Power0 to the Pset value with APC enabled, the output power value changes according to the Ctrl Speed value, but changes in the value to maintain the Pset value due to changes in the input power are performed at maximum speed, regardless of the Ctrl Speed value.



# 8.1 Change the Connection Route by OSW Module

## Single Type

### Changing the Connection Port

The port with port No. "A" is connected to that with any of port Nos. "1" to "n".

For "1 x 4", "n" becomes "4".

For "1 x 8", "n" becomes "8".

For "1 x 16", "n" becomes "16".

### Procedure

1. Press **DETAIL** to display the DETAIL screen.
2. Use the **SLOT** keys to select the OSW module as the current module.

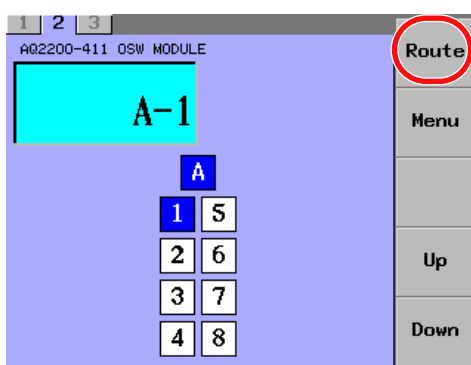

### Setting the Route in a Dialog Box

3. Press the **Route** soft key to display the Route dialog box.
4. Use the arrow keys to move the cursor to the connection route that you want to select, and press the **OK** soft key or **ENTER**.  
The route setting is then completed.

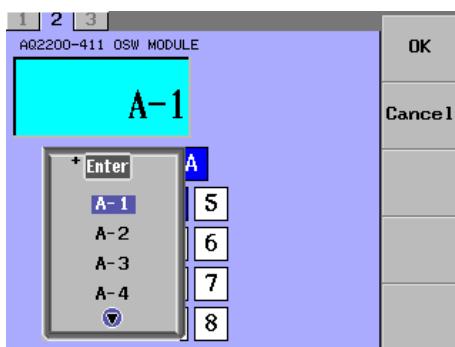

## 8.1 Change the Connection Route by OSW Module

---

### Setting the Route Using the Up and Down Soft Keys

3. Use the **Up** or **Down** soft key to move the cursor to the port number that you want to select, and press **ENTER**.

The route setting is then completed.

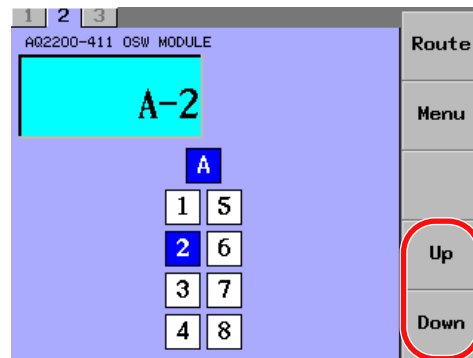

## Dual Type

## Changing the Connection Port

Ports A and B can be connected to ports 1 and 2.

In 1 × 2 connections, the connection route is either A-1 or A-2.

In 2 × 2 connections, the connection routes are A-1 and B-2 or A-2 and B-1.

## Procedure

1. Press **DETAIL** to display the DETAIL screen.
2. Use the **SLOT** keys to select the OSW module as the current module.

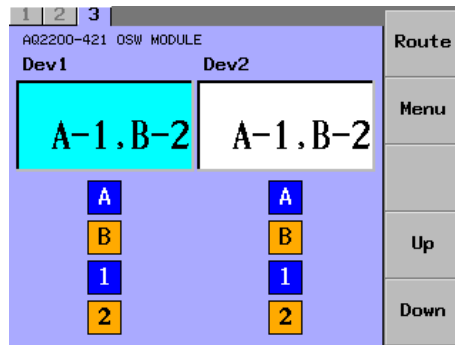

## Selecting a Device

3. Use the arrow keys to move the cursor to the device that you want to set.

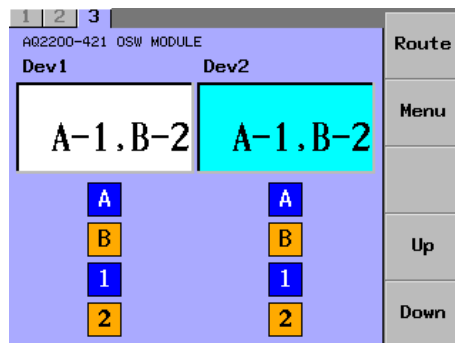

## Setting the Route in a Dialog Box

4. Press the **Route** soft key to display the Route dialog box.
5. Use the arrow keys to move the cursor to the connection route that you want to select, and press the **OK** soft key or **ENTER**.

The route setting is then completed.

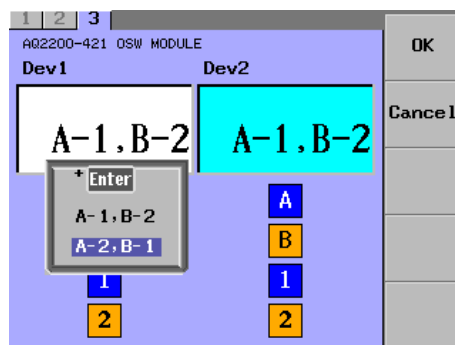

## 8.1 Change the Connection Route by OSW Module

---

### Setting the Route Using the Up and Down Soft Keys

4. Press the **Up** or **Down** soft key to switch between connection routes or connection route combinations.

The route setting is then completed.

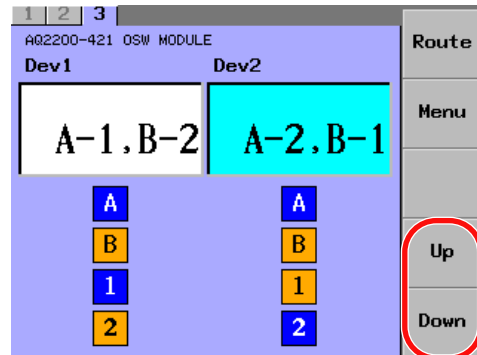

## 9.1 Basic Operating Procedures for BERT Module

On the detail screen for operation of individual modules, only the module-specific functions are displayed on screen. However, with the BERT APPLICATION (which combines related modules), BER measurement and measured results are shown no matter which page (screen) is displayed. It is also recommended to use the BERT APPLICATION function even when only one BERT module is used.

When you set parameters using the BERT application, the parameters for individual BERT modules also change.

When you set parameters using the BERT application, you do not need to set the parameters again for individual BERT modules.

## 9.2 10 Gbit/s BERT Module

### Display Screen

BERT modules have a DETAIL screen and a SUMMARY screen.

The tab Nos. at the upper portion of the DETAIL screen are assigned as shown below.

- 1: PPG
- 2: ED
- 3: SG

Pressing the SLOT key will change to the screen of the current module.

This section describes the display contents of the SUMMARY screen and DETAIL screen.

### SUMMARY Screen

#### 3-Slot Type

The screenshot shows a summary screen for a 3-slot type BERT module. The screen is divided into three main sections corresponding to the modules: PPG (top), ED (middle), and SG (bottom). Each section displays key parameters and their current values.

Module	Parameter	Value
PPG (A02200-601 BERT-PPG)	Signal Output	On
	Data Amplitude	1.00Vpp
ED (A02200-601 BERT-ED)	Input Select	DataIn 1
	ERRRate	0.000000E-10
SG (A02200-601 BERT-SG)	SG unlock	Green indicator
	Bitrate (Gbit/s)	9.953280

**Signal Output**  
Shows the output signal ON/OFF status of the PPG.

**Data Amplitude**  
Shows the amplitude of the PPG data output signal.

**Input Select**  
Shows the data input terminal of the ED.  
Data In 1: CDR  
Data In 2: Normal

**ERRRate**  
Shows the coding error rate (error rate) of the receive data.

**Bitrate**  
Shows the bitrate of the clock of the internal SG.  
9.950000 to 11.320000 [Gbit/s]

**SG unlock**  
Shows the operation status of the internal SG using indicators.

Indication	Status
Green	Normal status
Red	Error status

#### 9-Slot Type

A02212 FRAME CONTROLLER			Prog Edit
1	Signal Output	On	Data Amplitude 0.50Vpp
2	Input Select	DataIn 1	Err-rate
3	SG unlock	Green indicator	Bitrate (Gbit/s) 9.953280
4	NO MODULE		
5	NO MODULE		
6	NO MODULE		
7	NO MODULE		
8	NO MODULE		
9	NO MODULE		

\* For display items of the 9-slot type, see the display items of the 3-slot type.

### Note

On the SUMMARY screen, the information on all mounted modules is displayed at once.

## DETAIL Screen PPG Screen

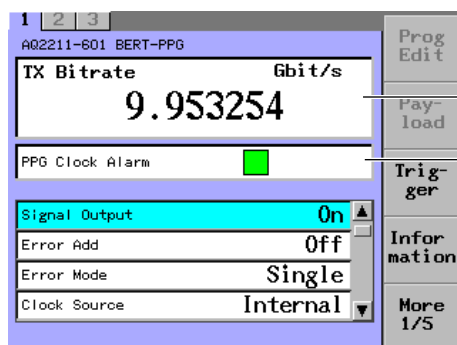

Indication	Status
Green	Normal status
Red	Error status

### Note

When using the internal clock, the clock status from the internal SG is shown. On the contrary, when using the external clock, the clock status from the external SG is shown.

### Soft Key Menu

Name	Function
Program Edit	When "Pattern = Prog256 (program pattern)" is selected, the arbitrary pattern is edited.
Payload*	When "Pattern = SOH/SONET (frame pattern)" is selected, the PRBS pattern length of payload is set and displayed.
Trigger	The signal to be output to [16] Trigger signal output terminal is set and displayed.
Information	Shows the version information.
Signal Output	The data output and clock output of the PPG are turned ON or OFF.
Error Add	Whether or not the coding error is added to the data output of the PPG is set.
Error Mode	Conditions for coding error to be added when Error add is ON are set and displayed.
Clock Source	The clock source of the PPG is set and displayed.
Divide Ratio	When the clock source is REF Clk, the frequency dividing ratio of the reference clock signal for external synchronization to bitrate is set and displayed.
Logic	Whether the PPG data output signal is positive logic or negative logic is set and displayed.
PPG IF	Whether the electrical interface (BERT module only) is used or optical interface (optional optical modulation module) is used together is set and displayed.
Data Ampli	The amplitude of the PPG data output signal is set and displayed.
Data Offset	The DC offset voltage of the PPG data output signal is set and displayed.
Data Cross	The cross point position of Non-invert data output terminal of the PPG data output signal is set and displayed.
Clock Offset	The DC offset voltage of the clock output signal is set and displayed.
Setup	Whether the PPG and ED patterns of the data setting are set individually or the same setting is performed is set and displayed.
Pattern	The type of the PPG output data is set and displayed.
PRBS Length	When "Pattern = PRBS (pseudo random pattern)" is selected, the number of PRBS pattern length is set and displayed.
Short Length	When "Pattern = Prog256 (program pattern)" is selected, the bit length of the arbitrary pattern is set and displayed.
Long Length*	When "Pattern = Prog64M (program pattern)" is selected, the bit length of the arbitrary pattern is set and displayed.

\* Only valid on models with the appropriate option.

ED Screen

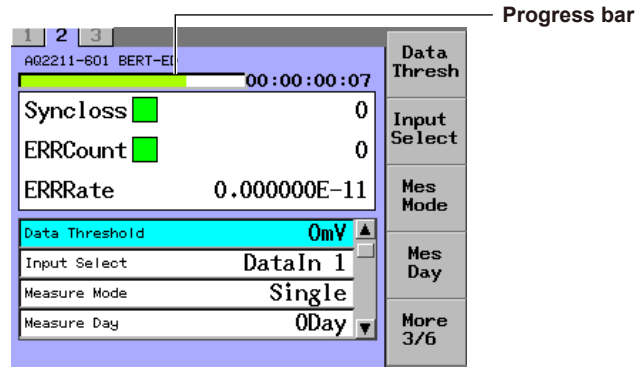

**Progress Bar/Elapsed Time Display**

Shows the measurement progress status using the progress bar and the elapsed time.

- **Progress Bar**

Indication	Progress status
Green	Processed portion
White	Unprocessed portion

- **Elapsed Time: [dd]:[hh]:[mm]:[ss]**

Max: 10 days =10:00:00:00

**Note**

The progress bar graphically shows the progress status of the measurement time when the Measure mode is set at "Single" or "Repeat".

When the Measure mode is set at "Manual", the overall progress bar is displayed in green.

**Syncloss**

Shows the synchronization status of the ED using the indicators and sync loss time [unit:  $\mu$ s].

- **Synchronization Status**

Indication	Status
Green	Synchronization has been established between measurement start and current operation.
Yellow	Synchronization was not established in the past, but it is established currently.
Red	Sync loss status

- **Sync Loss Time**

Display range: 0 to 999999999 [ $\mu$ s] and 1.000000E+09 to 8.640000E+11 [ $\mu$ s]

**ERRCount**

Shows the coding error status using the indicators and the number of coding errors (number of error bits) [unit: bit].

- **Coding Error Status**

Indication	Status
Green	No coding error has occurred between measurement start and current operation.
Yellow	Coding error occurred in the past, but no coding error occurs currently.
Red	Coding error status

- **Number of Coding Errors**

Display range: 0 to 999999999 [bit] and 1.000000E+09 to 9.780480E+15 [bit]



**Note**

You can return the Syncloss and ERRCount indicators to their normal conditions by starting a measurement or by using Clear Hist.

**ERRRate**

Shows the coding error rate (error rate).

- **Coding error rate**

Display range: 0.000000E-10 (to E-16)\* (error free)  
 to 1.022444E-16 (error occurs.)  
 to 1.000000E-00 (all are errors.)

\* The exponential may vary depending on the period of measurement. However, the resulting value is identical.

**Note**

In the Syncloss (sync loss) status, the error measurement is not performed.  
 For example, when 10sec.-measurement is made once and Syncloss occurs for 4 sec. (4000000 [μs]), the error measurement is actually performed for 6 sec. (6000000 [μs]).  
 In this case, 6sec.-ERRCount and ERRRate may result.

**When the Result Display Is Shown**

**Rx Bitrate**  
 Shows the receive bitrate of the ED using the numeric value.  
 Display range: 9.950000 to 11.320000 [Gbit/s]

**CDR ulk**  
 Shows the operation status of the CDR function of the ED using the indicators.

Indication	Status
Green	Clock regeneration succeeded status
Red	Clock regeneration failed status

**ED Clock Alarm**  
 Shows the receive clock status of the ED using the indicators.

Indication	Status
Green	Normal status
Red	Error status

**Soft Key Menu**

<b>Name</b>	<b>Function</b>
Information	Shows the version information.
Result Disp	The Result screen is displayed.
Measure	The measurement is started or stopped.
Disp Mode	The timing to update the screen is set and displayed.
Clear Hist	The measurement history is cleared.
Data Thresh	The threshold voltage of the data input of the ED is set and displayed.
Input Select	The input terminal of the ED data signal is set and displayed.
Mes Mode	The measurement mode is set and displayed.
Mes Day	The measurement period (number of days) is set and displayed.
Mes Time	The measurement period (hour, minute, second) is set and displayed.
Buzzer	The buzzer sound volume, which is given if the error is detected, is set and displayed.
Auto Sync	Whether the auto synchronization of the ED is turned ON or OFF is set and displayed.
Logic	Whether the ED data input is the positive logic or negative logic is set and displayed.
Setup	Whether the PPG and ED patterns of the data setting are set individually or the same setting is performed is set and displayed.
Pattern	The type of the ED measurement data is set and displayed.
PRBS Length	When "Pattern = PRBS (pseudo random pattern)" is selected, the number of PRBS pattern length is set and displayed.
Short Length	When "Pattern = Prog256 (program pattern)" is selected, the bit length of the arbitrary pattern is set and displayed.
Long Length*	When "Pattern = Prog64M (program pattern)" is selected, the bit length of the arbitrary pattern is set and displayed.
Program Edit	When "Pattern = Prog256 (program pattern)" is selected, the arbitrary pattern is edited.
Payload*	When "Pattern = SOH/SONET (frame pattern)" is selected, the PRBS pattern length of payload is set and displayed.
Trigger	The signal to be output to Trigger signal output terminal is set and displayed.

\* Only valid on models with the appropriate option.

### SG Screen

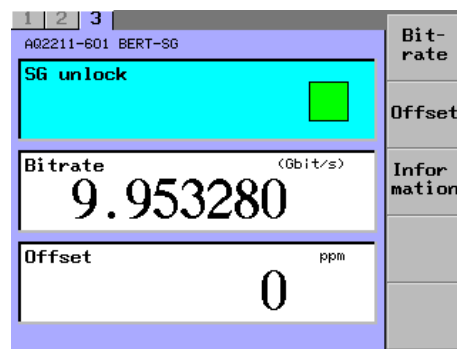

### SG Unlock

Shows the operation status of the internal SG using the indicators.

- **Status**

Indication	Status
Green	Normal status
Red	Error status

### Bitrate

Shows the bitrate of the built-in SG.

9.950000 to 11.320000 [Gbit/s]

### Offset

Shows the frequency displacement amount of the bitrate.

-100 to 100 [ppm]

### Soft Key Menu

Name	Function
Bitrate	The bitrate of the built-in SG clock is set and displayed.
Offset	The frequency displacement amount from the set bitrate is set and displayed in units of ppm.
Information	Shows the version information.

### Screen Configuration Diagram

Screen Name (Tab)	Setup Item	Set Value
PPG	Signal Output <sup>3</sup>	On, Off
	Error Add	On, Off
	Error Mode	Single, 1.0E-3, 1.0E-4, 1.0E-5, 1.0E-6, 1.0E-7, 1.0E-8, 1.0E-9, 1.0E-10, 1.0E-11, 1.0E-12
	Clock Source	Internal, REF Clk, Ext Clk
	Divide Ratio	1/16, 1/64
	Logic	Positive, Negative
	PPG IF	Electric, Optic
	Data Amplitude <sup>3</sup> [Data Ampli] <sup>2</sup>	0.50 to 2.00 [Vpp]
	Data Offset	-2.00 to 3.00 [V]
	Data Cross Point [Data Cross] <sup>2</sup>	30 to 70 [%]
	Clock Offset	-2.00 to 3.00 [V]
	Setup	PPG, Couple (Copy PPG -> ED), Couple (Copy ED -> PPG)
	Pattern	PRBS, Prog256, {Prog64M} <sup>1</sup> , {SDH/SONET} <sup>1</sup>
	PRBS Length	PRBS7, PRBS9, PRBS10, PRBS11, PRBS15, PRBS23, PRBS31
	Program Length [Short Length] <sup>2</sup>	16 to 256 [bit]
	Program Length (Long) [Long Length] <sup>2</sup>	{256 to 67108864 [bit]} <sup>1</sup>
	Program Edit	00 to FF in hexadecimal notation, 0/1 in binary notation.
	Payload	{PRBS9, PRBS10, PRBS11, PRBS15, PRBS23, PRBS31} <sup>1</sup>
	Trigger	TX1/16, TX1/64, TXPatt, TXERR, RX1/16, RX1/64, RXPatt, RXERR
	*Information	

\* Operated only with soft key.

1 Items in { } are valid only when optional function is selected.

2 Soft key is shown in [ ].

3 This item also appears in the SUMMARY screen.

Screen Name (Tab)	Setup Item	Set Value
ED	*Result Disp	
	*Measure	Start, Stop
	*Disp Mode	Current, 100ms, LAST
	*Clear Hist	
	Data Threshold [Data Thresh] <sup>2</sup>	-350 to 350 [mV] when Input select is Data In 1 (CDR). -300 to 300 [mV] when Input select is Data In 2 (Normal).
	Input Select <sup>3</sup>	Data In 1, Data In 2
	Measure Mode [Mes Mode] <sup>2</sup>	Single, Manual, Repeat
	Measure Day [Mes Day] <sup>2</sup>	0 to 10 [day]
	Measure Time [Mes Time] <sup>2</sup>	00:00:01 to 23:59:59 [h]:[m]:[s]
	Buzzer	Off, Soft, Medium, Loud
	Auto Sync	On, Off
	Logic	Positive, Negative
	Setup	ED, Couple (Copy PPG -> ED), Couple (Copy ED -> PPG)
	Pattern	PRBS, Prog256, {Prog64M} <sup>1</sup> , {SDH/SONET} <sup>1</sup>
	PRBS Length	PRBS7, PRBS9, PRBS10, PRBS11, PRBS15, PRBS23, PRBS31
	Program Length [Short Length] <sup>2</sup>	16 to 256 [bit]
	Program Length (Long) [Long Length] <sup>2</sup>	{256 to 67108864 [bit]} <sup>1</sup>
	Program Edit	00 to FF in hexadecimal notation, 0/1 in binary notation
	Payload	{PRBS9, PRBS10, PRBS11, PRBS15, PRBS23, PRBS31} <sup>*1</sup>
	Trigger	TX1/16, TX1/64, TXPat, TXERR, RX1/16, RX1/64, RXPat, RXERR
*Information		
SG	Bitrate <sup>3</sup>	9.95 to 11.32 [Gbit/s]
	Offset	-100 to 100 [ppm]
	*Information	

- \* Operated only with soft key.
- 1 Items in { } are valid only when optional function is selected.
- 2 Soft key is shown in [ ].
- 3 This item also appears in the SUMMARY screen.

## PPG Setting

### Turning ON or OFF the Output (Signal Output)

#### Procedure

1. Press **DETAIL** to display the DETAIL screen.
2. Use the **SLOT** keys to select the BERT module's PPG as the current module.
3. Press the **Signal Output** soft key, or move the cursor to Signal Output with the arrow keys, and then press the **ENTER**.  
The Signal Output dialog box will appear.

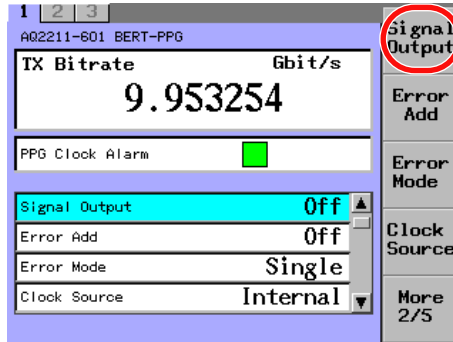

4. With the arrow keys, move the cursor to an item you want to change, and press the **OK** soft key or **ENTER**.  
The Signal Output dialog box will disappear and the item you have selected is then set and displayed.

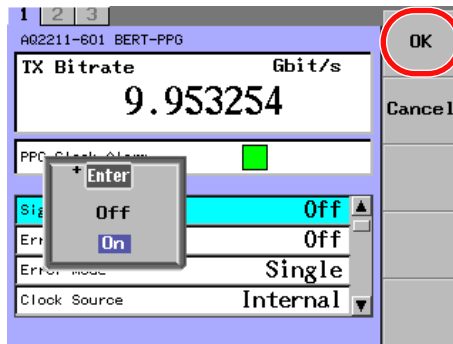

#### Note

For an explanation of how to select parameters, see section 2.3.

#### Explanation

The data output and clock output of the PPG are turned ON or OFF.

- On: Output is ON.
- Off: Output is OFF.

#### Note

The outputs of Non-invert data output terminal, Invert data output terminal, Non-Invert clock signal output terminal, Invert clock signal output terminal, and Data (for optical modulator) output terminal are turned ON or OFF at the same time.

## Adding the Error (Error Add)

### Procedure

1. Press **DETAIL** to display the DETAIL screen.
2. Use the **SLOT** keys to select the BERT module's PPG as the current module.
3. Press the **Error Add** soft key, or move the cursor to Error Add with the arrow keys, and then press the **ENTER**.  
The Signal Output dialog box will appear.

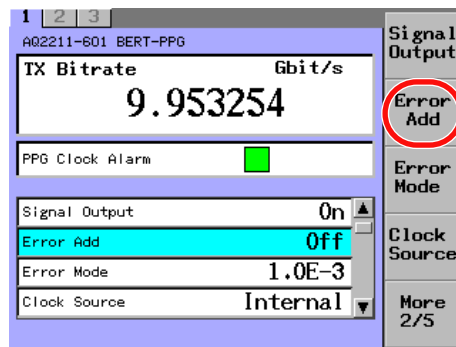

4. With the arrow keys, move the cursor to an item you want to change, and press the **OK** soft key or **ENTER**.  
The Error Add dialog box will disappear and the item you have selected is then set and displayed.

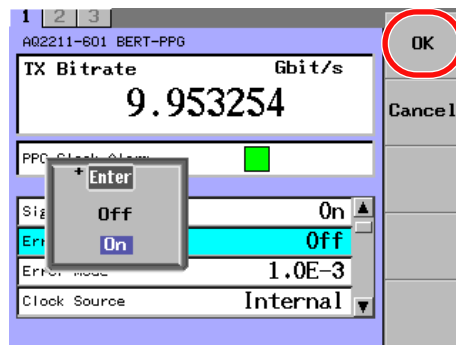

### Note

For an explanation of how to select parameters, see section 2.3.

### Explanation

Whether or not the coding error is added to the data output of the PPG is set.

- On: Added.
- Off: Not added.

When the Error mode is Single, Error add is automatically turned OFF after 1-bit error has been added when Error add is turned ON.

### Selecting the Error Rate (Error Mode)

#### Procedure

1. Press **DETAIL** to display the DETAIL screen.
2. Use the **SLOT** keys to select the BERT module's PPG as the current module.
3. Press the **Error Mode** soft key, or move the cursor to Error Mode with the arrow keys, and then press the **ENTER**.  
The Error Mode dialog box will appear.

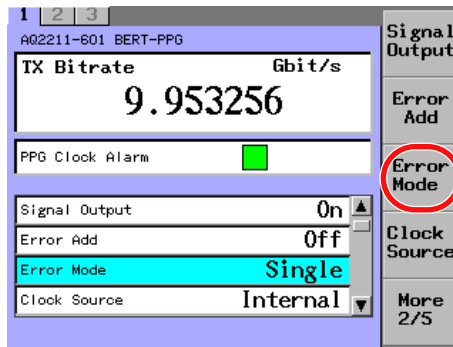

4. With the arrow keys, move the cursor to an item you want to change, and press the **OK** soft key or **ENTER**.  
The Error Mode dialog box will disappear and the item you have selected is then set and displayed.

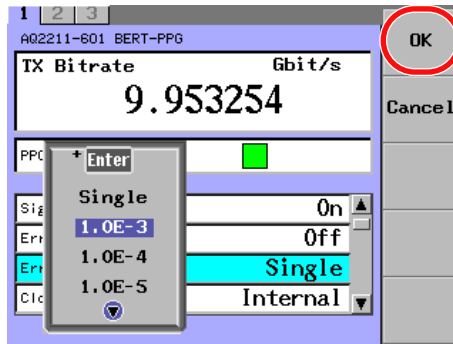

#### Note

For an explanation of how to select parameters, see section 2.3.

#### Explanation

Conditions for coding error to be added when Error add is ON are set and displayed.

- Single: When the Error add key is pressed, only 1-bit coding error is added.
- 1.0E-3 to 1.0E-12: Coding error is added at the selected coding error rate.



## Selecting the Clock Source (Clock Source)

### Procedure

1. Press **DETAIL** to display the DETAIL screen.
2. Use the **SLOT** keys to select the BERT module's PPG as the current module.
3. Press the **Clock Source** soft key, or move the cursor to Clock Source with the arrow keys, and then press the **ENTER**.  
The Clock Source dialog box will appear.

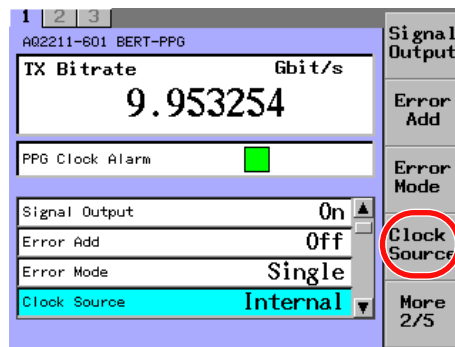

4. With the arrow keys, move the cursor to an item you want to change, and press the **OK** soft key or **ENTER**.  
The Clock Source dialog box will disappear and the item you have selected is then set and displayed.

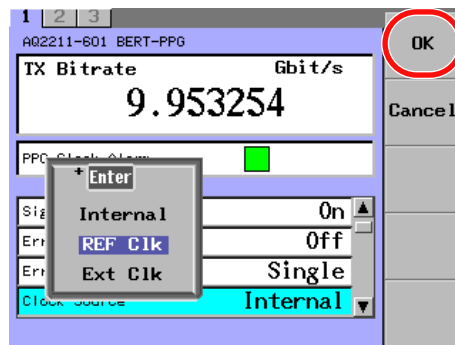

### Note

For an explanation of how to select parameters, see section 2.3.

### Explanation

The clock source of the PPG is set and displayed.

- Internal: The internal SG is used.
- REF Clk: The clock signal synchronized with the clock input to External synchronization input terminal is used.
- Ext Clk: Operated with 10GHz-band clock input to External clock input terminal.

Selecting the Frequency Dividing Ratio of the Reference Clock (Divide Ratio)

**Procedure**

1. Press **DETAIL** to display the DETAIL screen.
2. Use the **SLOT** keys to select the BERT module's PPG as the current module.
3. Press the **Divide Ratio** soft key, or move the cursor to Divide Ratio with the arrow keys, and then press the **ENTER**.  
The Divide Ratio dialog box will appear.

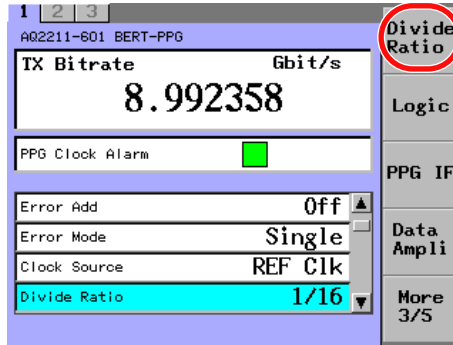

4. With the arrow keys, move the cursor to an item you want to change, and press the **OK** soft key or **ENTER**.  
The Divide Ratio dialog box will disappear and the item you have selected is then set and displayed.

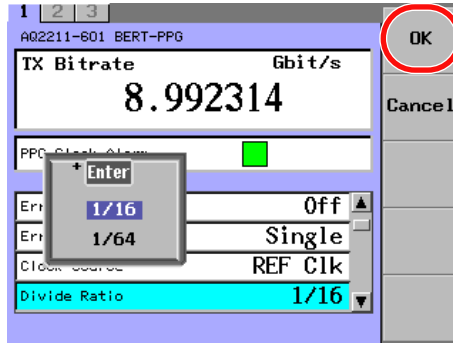

**Note**

- This item becomes valid when PEF Clk is selected for the Clock Source. When the Clock Source is set to Internal or Ext Clk, this item is dimmed (shown in gray) and it cannot be selected.
- For an explanation of how to select parameters, see section 2.3.

**Explanation**

When the clock source is the reference clock (REF Clk), the frequency dividing ratio when compared to the bitrate is set and displayed.

- 1/16: Clock is input, which is 1/16 of the bitrate.
- 1/64: Clock is input, which is 1/64 of the bitrate.

## Selecting the Output Data Logic (Logic)

### Procedure

1. Press **DETAIL** to display the DETAIL screen.
2. Use the **SLOT** keys to select the BERT module's PPG as the current module.
3. Press the **Logic** soft key, or move the cursor to Logic with the arrow keys, and then press the **ENTER**.

The Logic dialog box will appear.

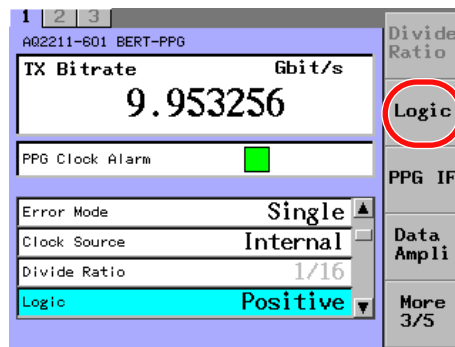

4. With the arrow keys, move the cursor to an item you want to change, and press the **OK** soft key or **ENTER**.

The Logic dialog box will disappear and the item you have selected is then set and displayed.

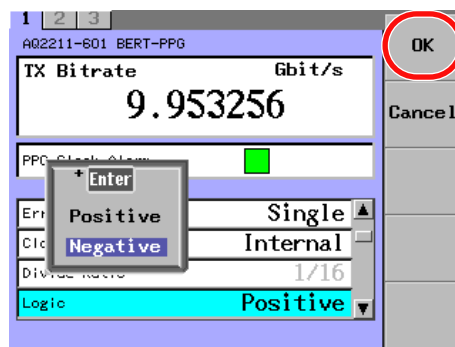

### Note

For an explanation of how to select parameters, see section 2.3.

### Explanation

Whether the PPG data output signal is the positive logic or negative logic is set and displayed.

- Positive: The positive logic is output from the data (non-invert) output terminal and the negative logic is output from the data (invert) output terminal.
- Negative: The negative logic is output from the data (non-invert) output terminal and the positive logic is output from the data (invert) output terminal.

### Selecting the PPG Interface (PPG IF)

#### Procedure

1. Press **DETAIL** to display the DETAIL screen.
2. Use the **SLOT** keys to select the BERT module's PPG as the current module.
3. Press the **PPG IF** soft key, or move the cursor to PPG IF with the arrow keys, and then press the **ENTER**.  
The PPG IF dialog box will appear.

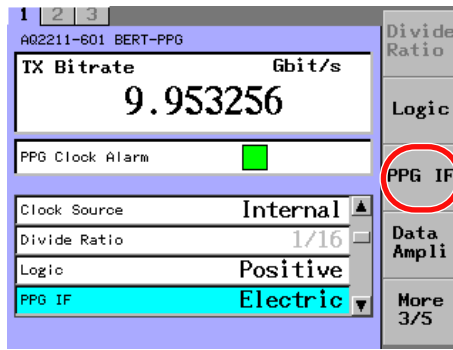

4. With the arrow keys, move the cursor to an item you want to change, and press the **OK** soft key or **ENTER**.  
The PPG IF dialog box will disappear and the item you have selected is then set and displayed.

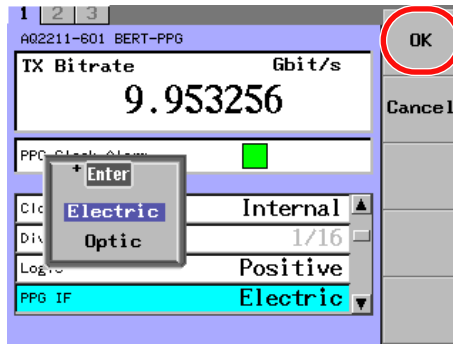

**Note**

For an explanation of how to select parameters, see section 2.3.

#### Explanation

Whether the electrical interface (BERT module only) is used or optical interface (optional optical modulation module) is used together is set and displayed.

- Electric: Electrical interface  
The non-inverted data output and inverted data output terminals are used. Even though the signal is also output to Data (for optical modulator) output terminal, the proper optical output cannot be obtained from the optical modulation module unless Optic is selected.
- Optic: Optical interface  
The optical interface optical output is used. The signal is not output to Non-invert data output terminal and Invert data output terminal. Data Amplitude, Data Offset, and Data Cross Point cannot be set.

## Setting the Data Amplitude (Data Amplitude)

### Procedure

1. Press **DETAIL** to display the DETAIL screen.
2. Use the **SLOT** keys to select the BERT module's PPG as the current module.
3. Press the **Data Ampli** soft key, or move the cursor to Data Amplitude with the arrow keys, and then press the **ENTER**.  
The Data Amplitude dialog box will appear.

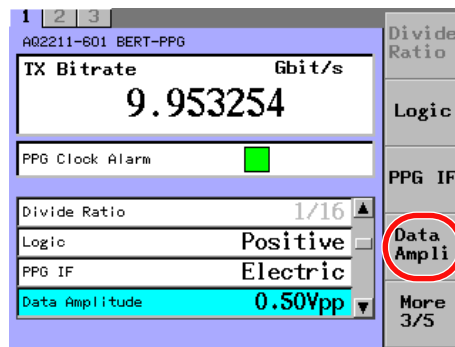

4. Change the numeric value with the numeric keypad or the arrow keys, and then press the **ENTER**.  
The Data Amplitude dialog box will disappear and the set value is then set and displayed.

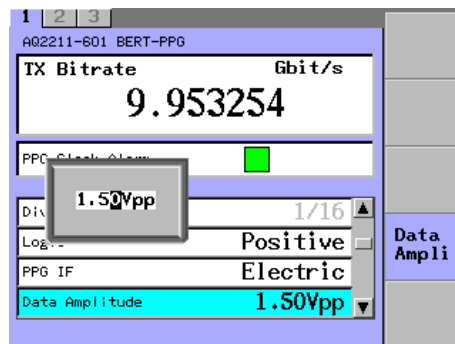

### Note

- This item becomes valid when Electric is selected for the PPG IF. When the PPG IF is set to Optic, this item is dimmed (shown in gray) and it cannot be selected.
- For an explanation of how to change values, see section 2.3.

### Explanation

The amplitude of the PPG data output signal is set and displayed.  
Both Non-invert data output terminal and Invert data output terminal are set with the same amplitude at the same time.  
Data Amplitude: 0.50 to 2.00 Vpp  
Step value: 0.01 Vpp

Setting the Offset Voltage of the Data (Data Offset)

**Procedure**

1. Press **DETAIL** to display the DETAIL screen.
2. Use the **SLOT** keys to select the BERT module's PPG as the current module.
3. Press the **Data Offset** soft key, or move the cursor to Data Offset with the arrow keys, and then press the **ENTER**.  
The Data Offset dialog box will appear.

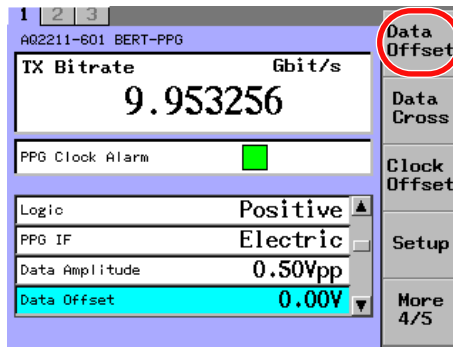

4. Change the numeric value with the numeric keypad or the arrow keys, and then press the **ENTER**.  
The Data Offset dialog box will disappear and the set value is then set and displayed.

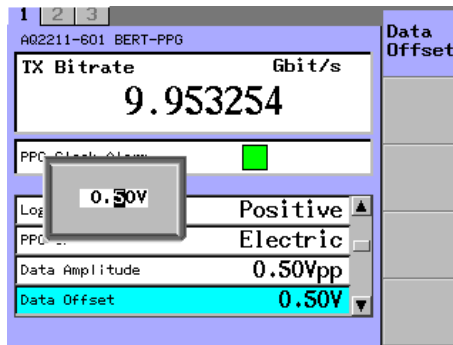

**Note**

For an explanation of how to change values, see section 2.3.

**Explanation**

The DC offset voltage of the PPG data output signal is set and displayed. Both Non-invert data output terminal and Invert data output terminal are set with the same offset voltage at the same time.  
Data Offset: -2.00 to 3.00 V  
Step value: 0.01 V

## Setting the Data Cross Point (Data Cross Point)

### Procedure

1. Press **DETAIL** to display the DETAIL screen.
2. Use the **SLOT** keys to select the BERT module's PPG as the current module.
3. Press the **Data Cross** soft key, or move the cursor to Data Cross Point with the arrow keys, and then press the **ENTER**.  
The Data Cross Point dialog box will appear.

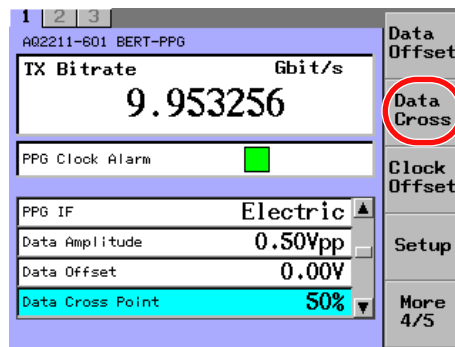

4. Change the numeric value with the numeric keypad or the arrow keys, and then press the **ENTER**.  
The Data Cross Point dialog box will disappear and the set value is then set and displayed.

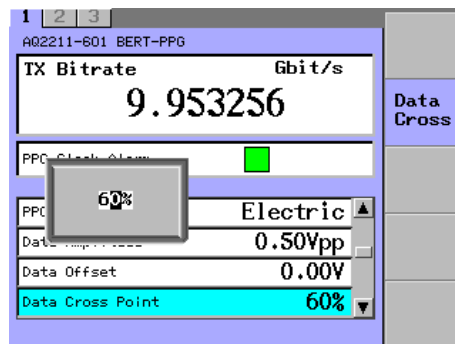

### Note

For an explanation of how to change values, see section 2.3.

### Explanation

The cross point position of the data non-invert output terminal of the PPG data output signal is set and displayed.

The cross point signal, that the setting ranging from 100[%] to set value is subtracted, is output to Invert data output terminal.

Data Cross Point: 30 to 70 %

Step value: 1 %

### Setting the Clock Offset Voltage (Clock Offset)

#### Procedure

1. Press **DETAIL** to display the DETAIL screen.
2. Use the **SLOT** keys to select the BERT module's PPG as the current module.
3. Press the **Clock Offset** soft key, or move the cursor to Clock Offset with the arrow keys, and then press the **ENTER**.  
The Clock Offset dialog box will appear.

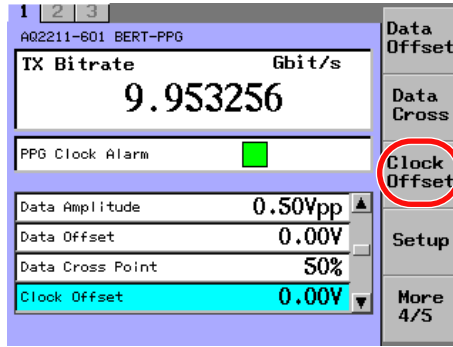

4. Change the numeric value with the numeric keypad or the arrow keys, and then press the **ENTER**.  
The Clock Offset dialog box will disappear and the set value is then set and displayed.

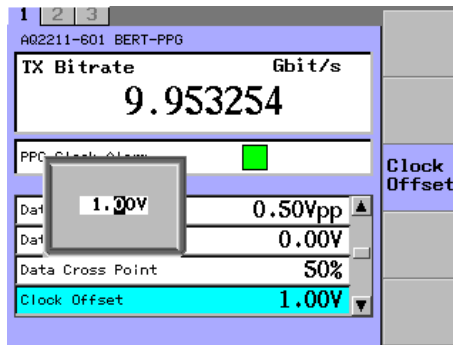

#### Note

For an explanation of how to change values, see section 2.3.

#### Explanation

The DC offset voltage of the clock output signal is set and displayed.  
The same offset voltage is output to both Non-invert clock signal output terminal and Invert clock signal output terminal.  
Clock Offset: -2.00 to 3.00 V  
Step value: 0.01 V



## Selecting the Data Setup Method (Setup)

### Procedure

1. Press **DETAIL** to display the DETAIL screen.
2. Use the **SLOT** keys to select the BERT module's PPG as the current module.
3. Press the **Setup** soft key, or move the cursor to Setup with the arrow keys, and then press the **ENTER**.

The Setup dialog box will appear.

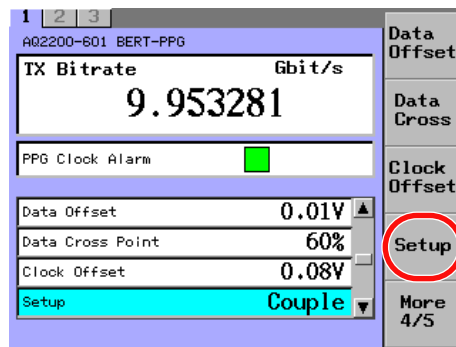

4. With the arrow keys, move the cursor to an item you want to change, and press the **OK** soft key or **ENTER**.

The Setup dialog box will disappear and the item you have selected is then set and displayed.

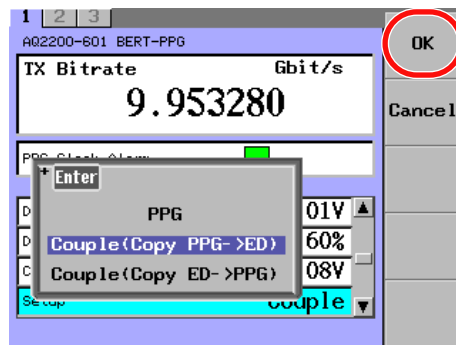

### Note

For an explanation of how to select parameters, see section 2.3.

### Explanation

Whether the PPG and ED patterns of the data setting are set individually or the same setting is performed is set and displayed.

- PPG: Only PPG is set individually.
- Couple (Copy PPG -> ED) : The data setting of PPG is copied to ED.
- Couple (Copy ED -> PPG) : The data setting of ED is copied to PPG.

### Selecting the Pattern (Pattern)

#### Procedure

1. Press **DETAIL** to display the DETAIL screen.
2. Use the **SLOT** keys to select the BERT module's PPG as the current module.
3. Press the **Pattern** soft key, or move the cursor to Pattern with the arrow keys, and then press the **ENTER**.  
The Pattern dialog box will appear.

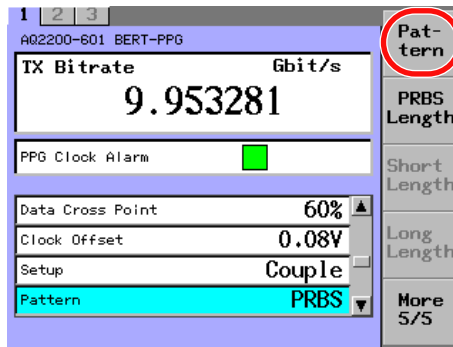

4. With the arrow keys, move the cursor to an item you want to change, and press the **OK** soft key or **ENTER**.  
The Pattern dialog box will disappear and the item you have selected is then set and displayed.

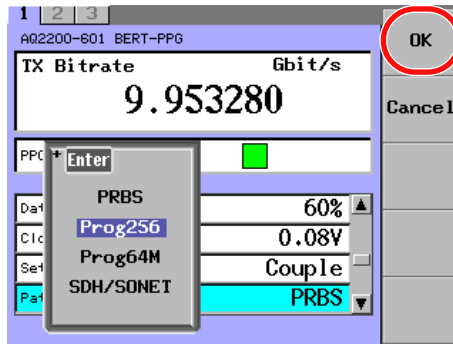

#### Note

- Prog64M appears on models with the /M option. SDH/SONET appears on models with the /P1 option.
- For an explanation of how to select parameters, see section 2.3.

#### Explanation

The type of the PPG output data is set and displayed.

- PRBS: PRBS (pseudo random pattern)
- Prog256: Arbitrary pattern (program pattern) 16 to 256 bits, 1 bit step
- Prog64M: Arbitrary pattern (program pattern) 256 to 67108864 bits, 128 bits step (/M option)
- SDH/SONET: SDH/SONET frame pattern (STM-64/STS-192) 155520 bytes (/P1 option)

## Selecting the Pattern Length of PRBS (PRBS Length)

### Procedure

1. Press **DETAIL** to display the DETAIL screen.
2. Use the **SLOT** keys to select the BERT module's PPG as the current module.
3. Press the **PRBS Length** soft key, or move the cursor to PRBS Length with the arrow keys, and then press the **ENTER**.  
The PRBS Length dialog box will appear.

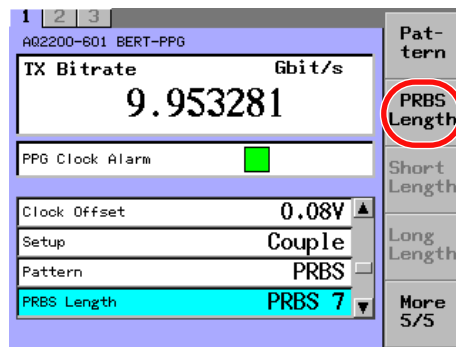

4. With the arrow keys, move the cursor to an item you want to change, and press the **OK** soft key or **ENTER**.  
The PRBS Length dialog box will disappear and the item you have selected is then set and displayed.

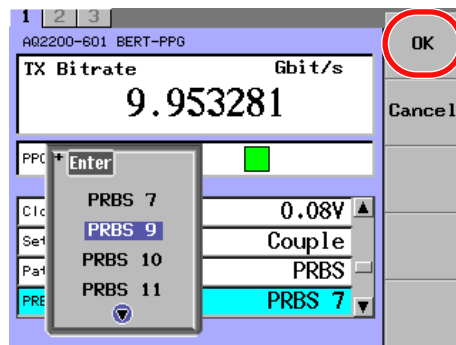

### Note

- This item becomes valid when PRBS is selected for the Pattern. When the Pattern is set to Prog256, Prog64M, or SDH/SONET, this item is dimmed (shown in gray) and it cannot be selected.
- For an explanation of how to select parameters, see section 2.3.

### Explanation

When Pattern = PRBS (Pseudo random pattern) is selected, the pattern length of PRBS is set and displayed.

PRBS Length: PRBS7, PRBS9, PRBS10, PRBS11, PRBS15, PRBS23, PRBS31

### Selecting the Program Length (Program Length)

#### Procedure

1. Press **DETAIL** to display the DETAIL screen.
2. Use the **SLOT** keys to select the BERT module's PPG as the current module.
3. Press the **Short Length** soft key, or move the cursor to Program Length with the arrow keys, and then press the **ENTER**.  
The Program Length dialog box will appear.

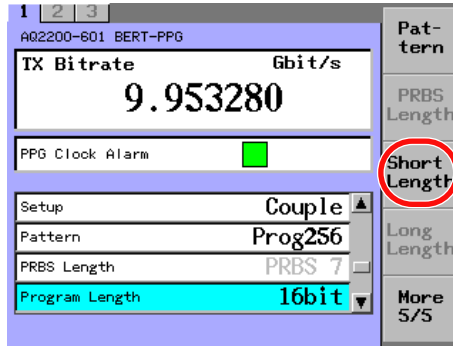

4. Change the numeric value with the numeric keypad or the arrow keys, and then press the **ENTER**.  
The Program Length dialog box will disappear and the set value is then set and displayed.

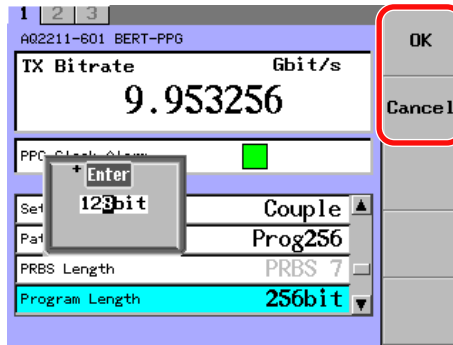

#### Note

- This item becomes valid when Prog256 is selected for the Pattern. When the Pattern is set to PRBS, Prog64M, or SDH/SONET, this item is dimmed (shown in gray) and it cannot be selected.
- For an explanation of how to change values, see section 2.3.
- When a value is changed with the arrow keys, you can use the OK and Cancel soft keys.

#### Explanation

When Pattern = Prog256 (program pattern) is selected, the bit length of the arbitrary pattern is set and displayed.

Program Length: 16 to 256 bit

Step value: 1 bit

## Selecting the Program Length (Program Length Long)

### Procedure

1. Press **DETAIL** to display the DETAIL screen.
2. Use the **SLOT** keys to select the BERT module's PPG as the current module.
3. Press the **Long Length** soft key, or move the cursor to Program Length (Long) with the arrow keys, and then press the **ENTER**.  
The Program Length (Long) dialog box will appear.

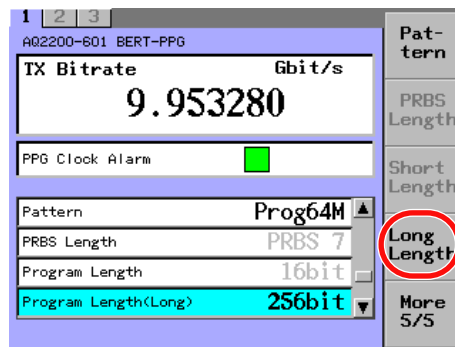

4. Change the numeric value with the numeric keypad or the arrow keys, and then press the **ENTER**.  
The Program Length (Long) dialog box will disappear and the set value is then set and displayed.

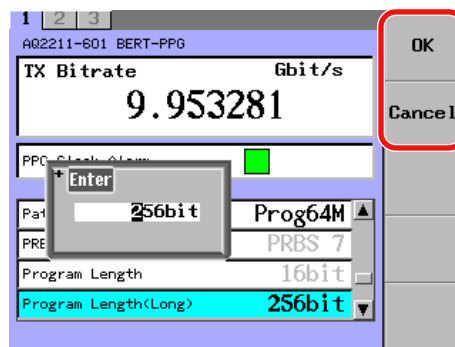

Only valid when a value is changed with the arrow keys

### Note

- This item is valid on models with the /M option when Pattern is set to Prog64M. When the Pattern is set to PRBS, Prog256, or SDH/SONET, this item is dimmed (shown in gray) and it cannot be selected.
- For an explanation of how to change values, see section 2.3.
- When a value is changed with the arrow keys, you can use the OK and Cancel soft keys.

### Explanation

When Pattern = Prog64M (program pattern) is selected, the bit length of the arbitrary pattern is set and displayed.

Program Length Long: 256 to 671088064 bit

Step value: 128 bit

### Editing the Program Pattern (Program Edit)

#### Procedure

1. Press **DETAIL** to display the DETAIL screen.
2. Use the **SLOT** keys to select the BERT module's PPG as the current module.
3. Press the **Prog Edit** soft key, or move the cursor to Program Edit with the arrow keys, and then press the **ENTER**.

The Program Edit screen will appear at the lower portion of the screen.

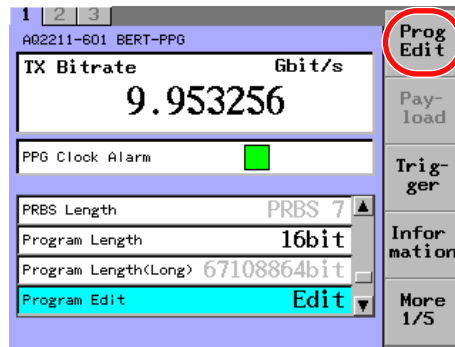

#### Selecting the Input Mode

4. Press the **Mode** soft key.  
The Mode dialog box will appear.

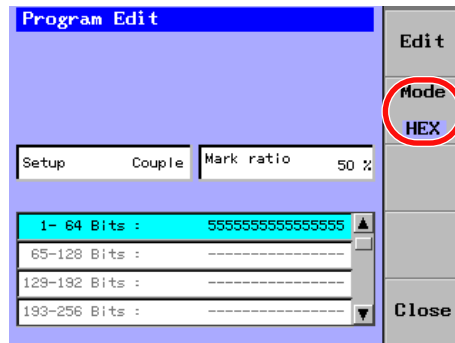

5. With the arrow keys, move the cursor to an item you want to change, and press the **OK** soft key or **ENTER**.  
The Mode dialog box will disappear and the item you have selected is then set and displayed.

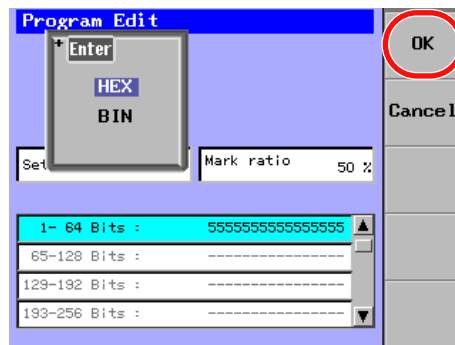

### Editing the Program Pattern

- Use the arrow keys to move the cursor to the editing area of the program pattern that you want to edit, and press the **Edit** soft key or **ENTER**.

In HEX mode a soft keyboard appears, while in BIN mode a numeric keypad appears.

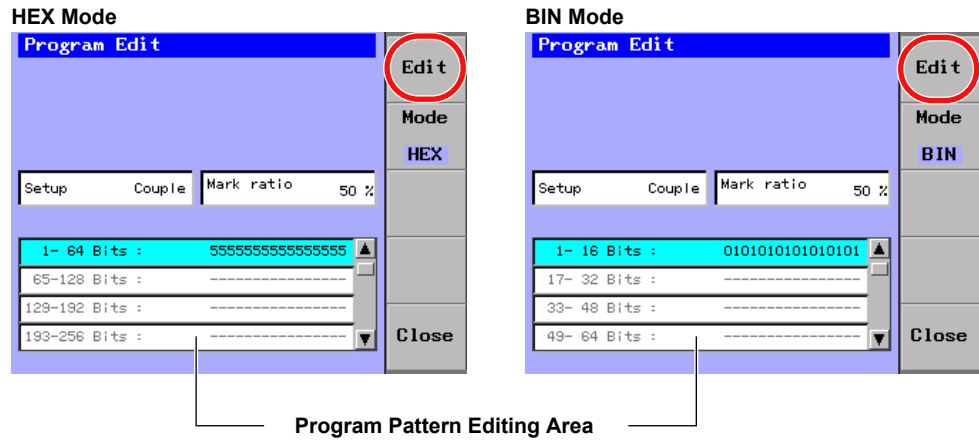

### In HEX Mode

- Use the soft keyboard to enter text, and press the **Commit** soft key. The data is confirmed and displayed.



- To edit other areas, repeat steps 6 to 7.
- Press the **Close** soft key to close the Program Edit screen.

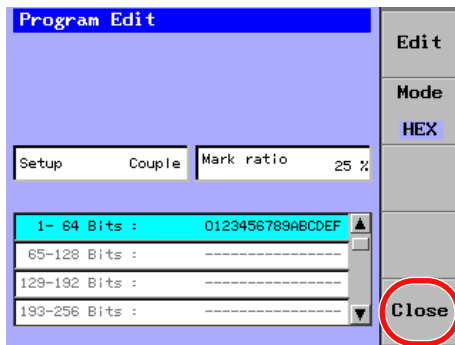

**In BIN Mode**

7. Use the numeric keypad to enter a value, and press **ENTER**.  
The data is confirmed and displayed.

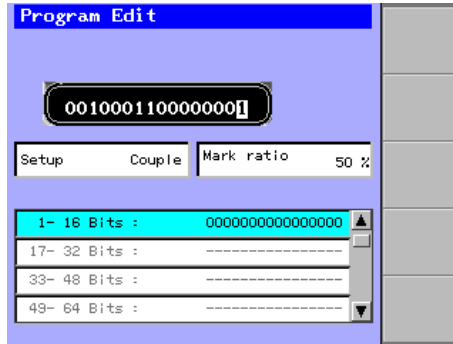

8. To edit other areas, repeat steps 6 to 7.
9. Press the **Close** soft key to close the Program Edit screen.

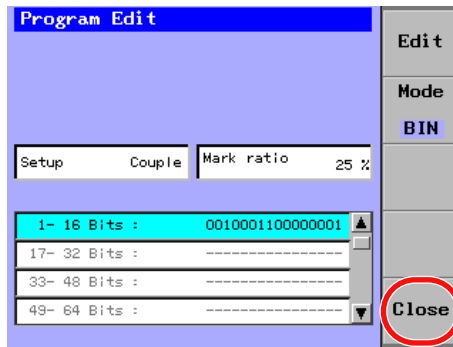

**Note**

- This item becomes valid when Prog256 is selected for the Pattern. When the Pattern is set to PRBS, Prog64M, or SDH/SONET, this item is dimmed (shown in gray) and it cannot be selected.
- For an explanation of how to change values, see section 2.3. For an explanation of how to enter text, see section 2.4.

**Explanation**

When Pattern = Prog256 (program pattern) is selected, the arbitrary pattern is edited.

- 00 to FF (Hexadecimal notation)
- 0/1 (Binary notation)



## Selecting the Payload Pattern (Payload)

### Procedure

1. Press **DETAIL** to display the DETAIL screen.
2. Use the **SLOT** keys to select the BERT module's PPG as the current module.
3. Press the **Payload** soft key, or move the cursor to Payload with the arrow keys, and then press the **ENTER**.  
The Payload dialog box will appear.

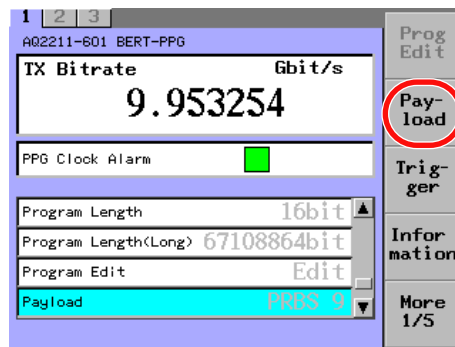

4. With the arrow keys, move the cursor to an item you want to change, and press the **OK** soft key or **ENTER**.  
The Payload dialog box will disappear and the item you have selected is then set and displayed.

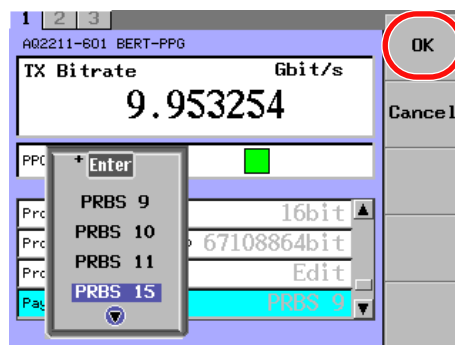

### Note

- This item is valid on models with the /P1 option when Pattern is set to SDH/SONET. When the Pattern is set to PRBS, Prog256, or Prog64M, this item is dimmed (shown in gray) and it cannot be selected.
- For an explanation of how to select parameters, see section 2.3.

### Explanation

When Pattern = SOH/SONET (frame pattern) is selected, the PRBS pattern length of payload is set and displayed.

Payload: PRBS9, PRBS10, PRBS11, PRBS15, PRBS23, PRBS31

## Selecting the Trigger (Trigger)

### Procedure

1. Press **DETAIL** to display the DETAIL screen.
2. Use the **SLOT** keys to select the BERT module's PPG as the current module.
3. Press the **Trigger** soft key, or move the cursor to Trigger with the arrow keys, and then press the **ENTER**.

The Trigger dialog box will appear.

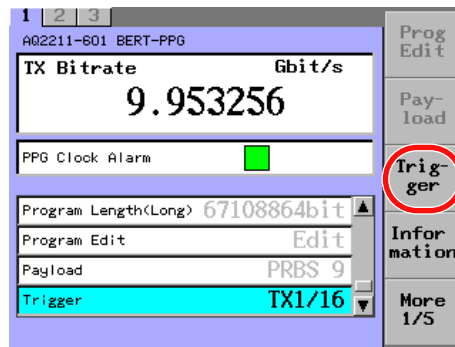

4. With the arrow keys, move the cursor to an item you want to change, and press the **OK** soft key or **ENTER**.

The Trigger dialog box will disappear and the item you have selected is then set and displayed.

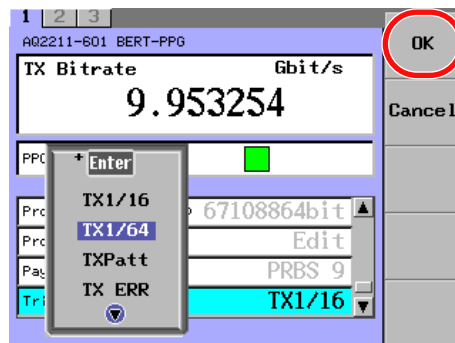

### Note

- This setting is the same as the ED trigger selection setting (Trigger).
- For an explanation of how to select parameters, see section 2.3.

### Explanation

The signal to be output to Trigger output terminal is set and displayed.

- TX1/16: Outputs the signal, which is 1/16 of the clock frequency.
- TX1/64: Outputs the signal, which is 1/64 of the clock frequency.
- TX Patt: Outputs the trigger signal synchronized with the output pattern. In case of PRBS, the pulse is output once every 128 cycles.
- TX ERR: Outputs the signal every time the error is added to the PPG.
- RX1/16: Outputs the signal, which is 1/16 of the input clock or regeneration clock frequency.
- RX1/64: Outputs the signal, which is 1/64 of the input clock or regeneration clock frequency.
- RX Patt: Outputs the trigger signal synchronized with the input pattern. In case of PRBS, the pulse is output once every 128 cycles.
- RX ERR: Outputs the signal every time the error is detected in the input signal.

## ED Setting

### Selecting the Measurement Mode (Measure Mode)

#### Procedure

1. Press **DETAIL** to display the DETAIL screen.
2. Use the **SLOT** keys to select the BERT module's ED as the current module.
3. Press the **Mes Mode** soft key, or move the cursor to Measure Mode with the arrow keys, and then press the **ENTER**.  
The Measure Mode dialog box will appear.

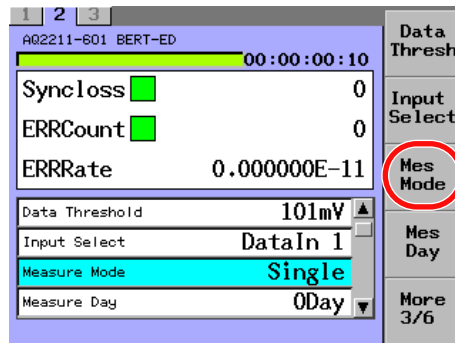

4. With the arrow keys, move the cursor to an item you want to change, and press the **OK** soft key or **ENTER**.  
The Measure Mode dialog box will disappear and the item you have selected is then set and displayed.

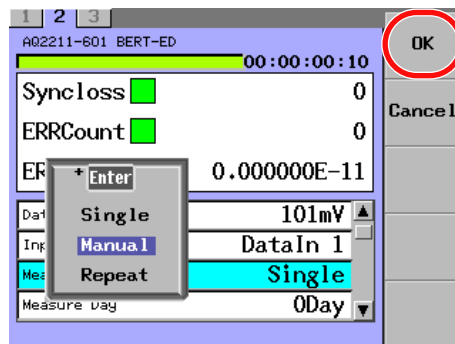

#### Note

- When Single is selected for the Measure Mode, the measurement is started with Measure Start and it is continued for the measurement period set in the Measure Day/Measure Time. When the set measurement period has elapsed, the measurement is stopped automatically.
- When Manual is selected for the Measure Mode, the measurement is performed from starting with Measure Start to stopping with Measure Stop. At this time, when the elapsed measurement period becomes 10 days, the measurement is stopped automatically.
- When Repeat is selected for the Measure Mode, the measurement is started with Measure Start and it is performed repeatedly for the measurement period set in the Measure Day/Measure Time. The measurement is continued until stopped by Measure Stop.
- For an explanation of how to select parameters, see section 2.3.

### **Explanation**

The measurement mode is set and displayed.

- Single: The measurement is performed for a period of measurement time set in Measure Day/Measure Time.
- Manual: The measurement is performed until the measurement is stopped. (However, note that the maximum measurement period is 10 days.)
- Repeat: The measurement is performed repeatedly for a period of measurement time set in Measure Day/Measure Time.

## Setting the Measurement Period (Measure Day/Measure Time)

### Procedure

1. Press **DETAIL** to display the DETAIL screen.
2. Use the **SLOT** keys to select the BERT module's ED as the current module.

### Setting the Number of Days

3. Press the **Mes Day** soft key, or move the cursor to Measure Day with the arrow keys, and then press the **ENTER**.

The Measure Day dialog box will appear.

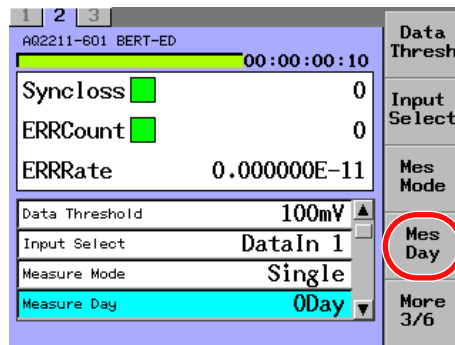

4. Change the numeric value with the numeric keypad or the arrow keys, and then press the **ENTER**.

The Measure Day dialog box will disappear and the set value is then set and displayed.

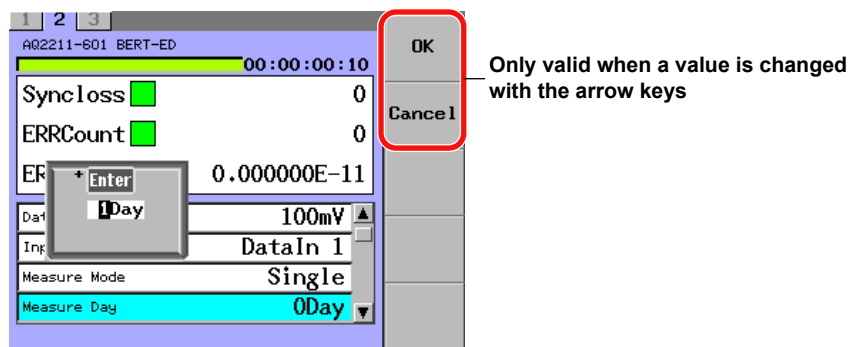

### Setting the Hour, Minute, and Second

3. Press the **Mes Time** soft key, or move the cursor to Measure Time with the arrow keys, and then press the **ENTER**.

The Measure Time dialog box will appear.

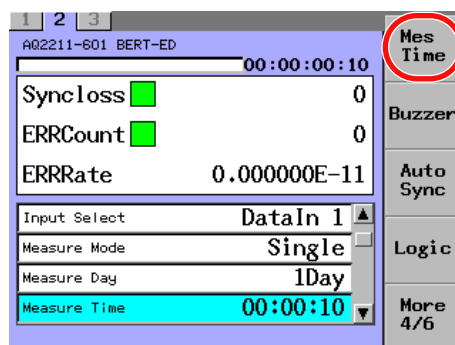

- Use the arrow keys to move the cursor to the unit of time that you want to change (hours, minutes, or seconds), and press **ENTER**.  
A dialog box for setting the unit of time that you specified will appear.

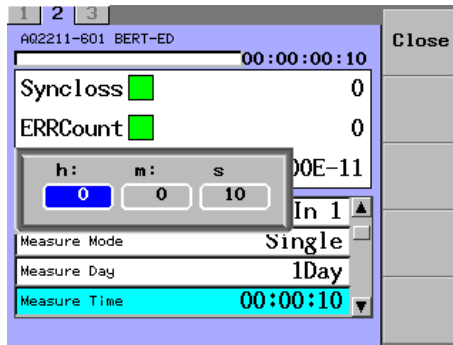

- Change the numeric value with the numeric keypad or the arrow keys, and then press the **ENTER**.  
The dialog box for setting the unit of time that you specified will close.

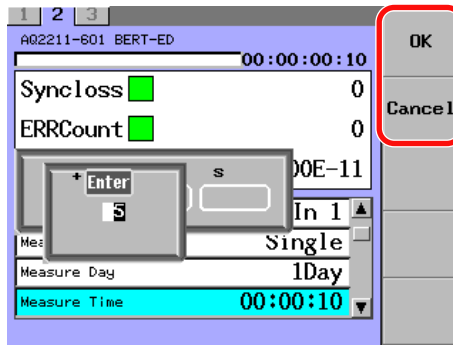

Only valid when a value is changed with the arrow keys

- Press the **Close** soft key.  
The Measure Time dialog box will disappear and the set value is then set and displayed.

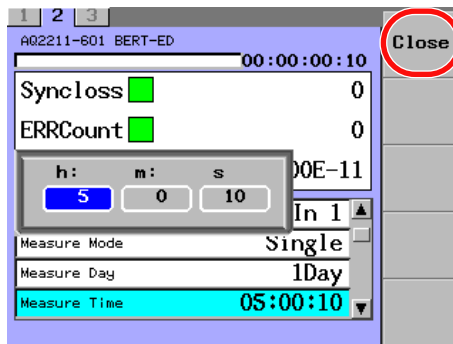

**Note**

- This item becomes valid when Single or Repeat is selected for the Measure Mode.
- For an explanation of how to change values, see section 2.3.
- When a value is changed with the arrow keys, you can use the OK and Cancel soft keys.

**Explanation**

The measurement period (number of days)(hour, minute, second) is set and displayed.  
The maximum measurement period is 10 days.  
Measure Day: 0 to 10 day, 1 day step  
Measure Time: 00:00:01 to 23:59:59 h:m:s, 1s step

## Selecting the Buzzer Sound Volume (Buzzer)

### Procedure

1. Press **DETAIL** to display the DETAIL screen.
2. Use the **SLOT** keys to select the BERT module's ED as the current module.
3. Press the **Buzzer** soft key, or move the cursor to Buzzer with the arrow keys, and then press the **ENTER**.

The Buzzer dialog box will appear.

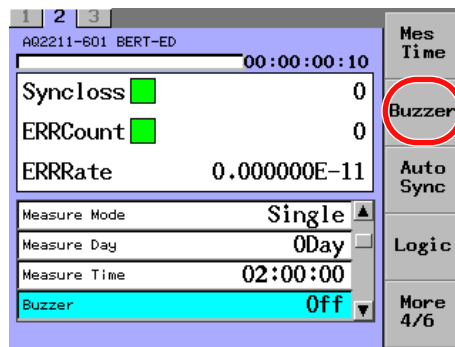

4. With the arrow keys, move the cursor to an item you want to change, and press the **OK** soft key or **ENTER**.

The Buzzer dialog box will disappear and the item you have selected is then set and displayed.

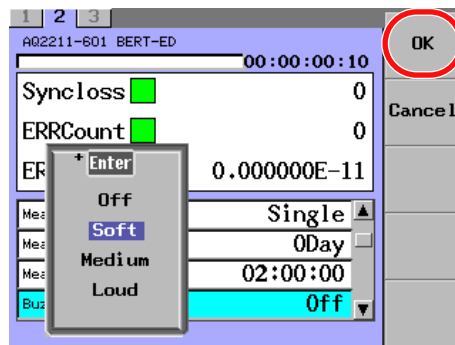

### Note

- This function is used to set the buzzer sound volume if an error is detected.
- The buzzer sound volume for key operation is set using Volume on the system screen. For details, see section 13.5.
- For an explanation of how to select parameters, see section 2.3.

### Explanation

The buzzer sound volume, which is given if the error is detected, is set and displayed.

Buzzer

- Off: No buzzer sound
- Soft: Small buzzer sound
- Medium: Medium buzzer sound
- Loud: Loud buzzer sound

## Selecting the Trigger (Trigger)

### Procedure

1. Press **DETAIL** to display the DETAIL screen.
2. Use the **SLOT** keys to select the BERT module's ED as the current module.
3. Press the **Trigger** soft key, or move the cursor to Trigger with the arrow keys, and then press the **ENTER**.

The Trigger dialog box will appear.

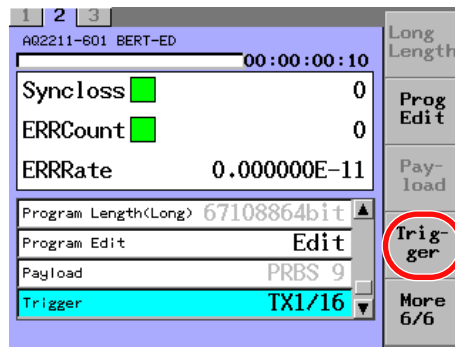

4. With the arrow keys, move the cursor to an item you want to change, and press the **OK** soft key or **ENTER**.

The Trigger dialog box will disappear and the item you have selected is then set and displayed.

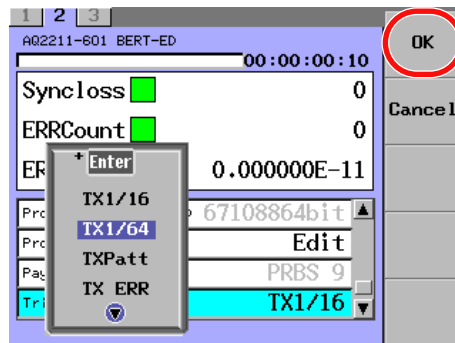

### Note

- This setting is the same as the PPG trigger selection setting (Trigger).
- For an explanation of how to select parameters, see section 2.3.

### Explanation

The signal to be output to Trigger output terminal is set and displayed.

- TX1/16: Outputs the signal, which is 1/16 of the clock frequency.
- TX1/64: Outputs the signal, which is 1/64 of the clock frequency.
- TXPatt: Outputs the trigger signal synchronized with the output pattern. In case of PRBS, the pulse is output once every 128 cycles.
- TX ERR: Outputs the signal every time the error is added to the PPG.
- RX1/16: Outputs the signal, which is 1/16 of the input clock or regeneration clock frequency.
- RX1/64: Outputs the signal, which is 1/64 of the input clock or regeneration clock frequency.
- RXPatt: Outputs the trigger signal synchronized with the input pattern. In case of PRBS, the pulse is output once every 128 cycles.
- RX ERR: Outputs the signal every time the error is detected in the input signal.



## Selecting the Data Input Terminal (Input Select)

### Procedure

1. Press **DETAIL** to display the DETAIL screen.
2. Use the **SLOT** keys to select the BERT module's ED as the current module.
3. Press the **Input Select** soft key, or move the cursor to Input Select with the arrow keys, and then press the **ENTER**.  
The Input Select dialog box will appear.

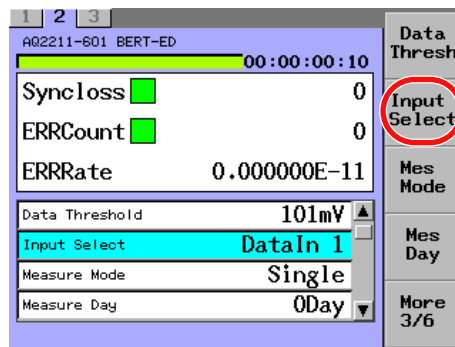

4. With the arrow keys, move the cursor to an item you want to change, and press the **OK** soft key or **ENTER**.  
The Input Select dialog box will disappear and the item you have selected is then set and displayed.

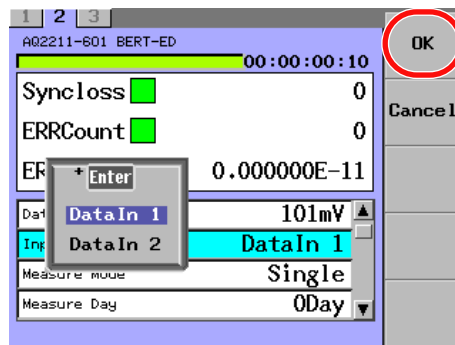

### Note

For an explanation of how to select parameters, see section 2.3.

### Explanation

The data signal input terminal of the ED is set and displayed.

- Data In 1: CDR is used.  
The signal of Data input 1 terminal built into the CDR is measured.
- Data In 2: CDR is not used.  
The signal of Data input 2 terminal is measured. When selecting this item, the clock input is required.

### Setting the Data Threshold Value (Data Threshold)

#### Procedure

1. Press **DETAIL** to display the DETAIL screen.
2. Use the **SLOT** keys to select the BERT module's ED as the current module.
3. Press the **Data Thresh** soft key, or move the cursor to Data Threshold with the arrow keys, and then press the **ENTER**.  
The Data Threshold dialog box will appear.

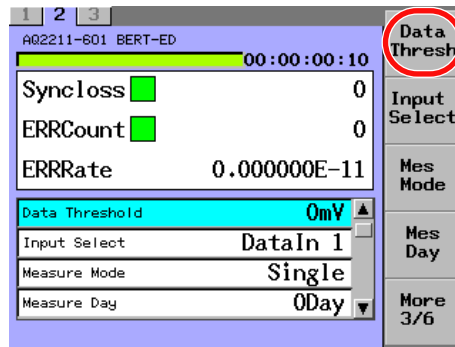

4. Change the numeric value with the numeric keypad or the arrow keys, and then press the **ENTER**.  
The Data Threshold dialog box will disappear and the set value is then set and displayed.

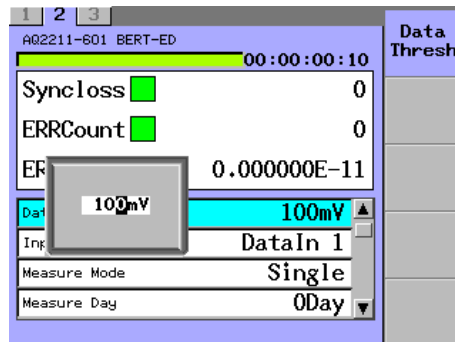

#### Note

For an explanation of how to change values, see section 2.3.

#### Explanation

The threshold voltage of the data input signal of the ED is set and displayed.  
 When Input Select is Data In 1: -350 to 350 mV, 1 mV step  
 When Input Select is Data In 2: -300 to 300 mV, 1 mV step

## Selecting the Synchronization Method (Auto Sync)

### Procedure

1. Press **DETAIL** to display the DETAIL screen.
2. Use the **SLOT** keys to select the BERT module's ED as the current module.
3. Press the **Auto Sync** soft key, or move the cursor to Auto Sync with the arrow keys, and then press the **ENTER**.  
The Auto Sync dialog box will appear.

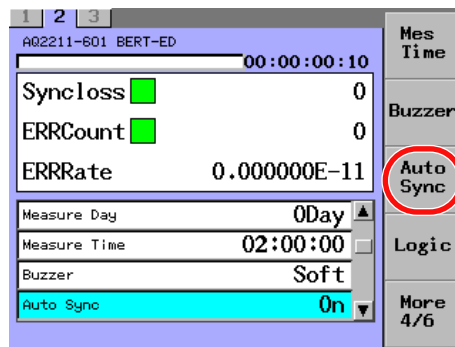

4. With the arrow keys, move the cursor to an item you want to change, and press the **OK** soft key or **ENTER**.  
The Auto Sync dialog box will disappear and the item you have selected is then set and displayed.

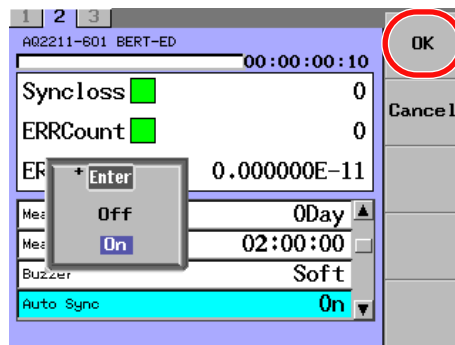

### Note

For an explanation of how to select parameters, see section 2.3.

### Explanation

Whether the auto synchronization of the ED is turned ON or OFF is set and displayed.

- On: Turns ON the auto synchronization.
- Off: Turns OFF the auto synchronization

Normally, this item is set at ON. However, when this item is set at OFF, the signal having many errors can be measured. For details, see section 1.6.

### Selecting the Data Setup Method (Setup)

#### Procedure

1. Press **DETAIL** to display the DETAIL screen.
2. Use the **SLOT** keys to select the BERT module's ED as the current module.
3. Press the **Setup** soft key, or move the cursor to Setup with the arrow keys, and then press the **ENTER**.

The Setup dialog box will appear.

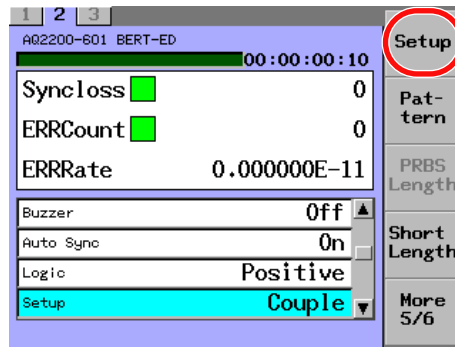

4. With the arrow keys, move the cursor to an item you want to change, and press the **OK** soft key or **ENTER**.

The Setup dialog box will disappear and the item you have selected is then set and displayed.

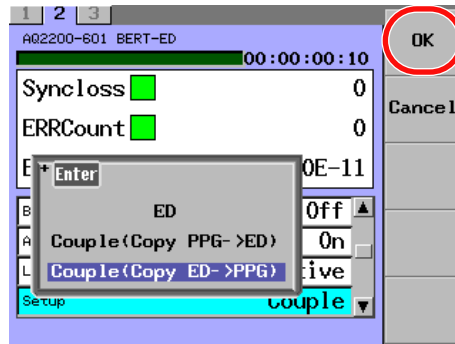

#### Note

For an explanation of how to select parameters, see section 2.3.

#### Explanation

Whether the PPG and ED patterns of the data setting are set individually or the same setting is performed is set and displayed.

- ED: Only ED is set individually.
- Couple (PPG -> ED) : The data setting of PPG is copied to ED.
- Couple (ED -> PPG) : The data setting of ED is copied to PPG.

## Selecting the Pattern (Pattern)

### Procedure

1. Press **DETAIL** to display the DETAIL screen.
2. Use the **SLOT** keys to select the BERT module's ED as the current module.
3. Press the **Pattern** soft key, or move the cursor to Pattern with the arrow keys, and then press the **ENTER**.

The Pattern dialog box will appear.

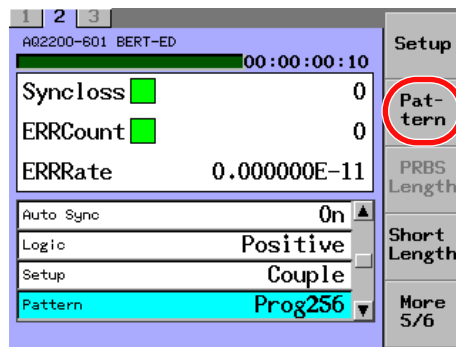

4. With the arrow keys, move the cursor to an item you want to change, and press the **OK** soft key or **ENTER**.

The Pattern dialog box will disappear and the item you have selected is then set and displayed.

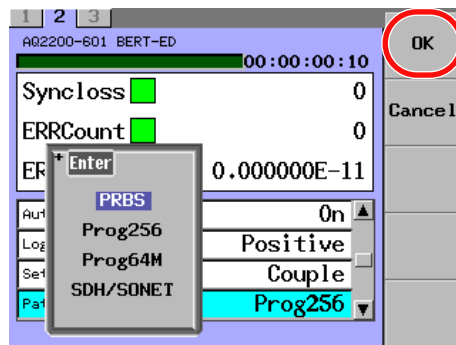

### Note

- Prog64M appears on models with the /M option. SDH/SONET appears on models with the /P1 option.
- For an explanation of how to select parameters, see section 2.3.

### Explanation

The type of the ED measurement data is set and displayed.

- PRBS: PRBS (pseudo random pattern)
- Prog256: Arbitrary pattern (program pattern) 16 to 256 bits, 1 bit step
- Prog64M: Arbitrary pattern (program pattern) 256 to 67108864 bits, 128 bits step (/M option)
- SDH/SONET: SDH/SONET frame pattern (STM-64/STS-192) 155520 bytes (/P1 option)

### Selecting the Pattern Length of PRBS (PRBS Length)

#### Procedure

1. Press **DETAIL** to display the DETAIL screen.
2. Use the **SLOT** keys to select the BERT module's ED as the current module.
3. Press the **PRBS Length** soft key, or move the cursor to PRBS Length with the arrow keys, and then press the **ENTER**.  
The PRBS Length dialog box will appear.

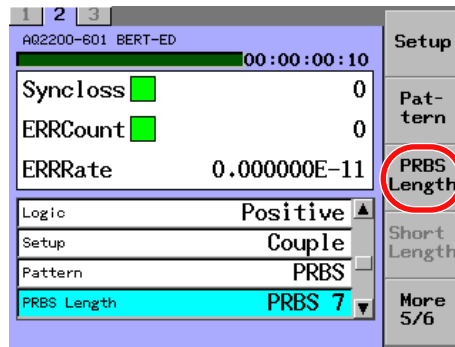

4. With the arrow keys, move the cursor to an item you want to change, and press the **OK** soft key or **ENTER**.  
The PRBS Length dialog box will disappear and the item you have selected is then set and displayed.

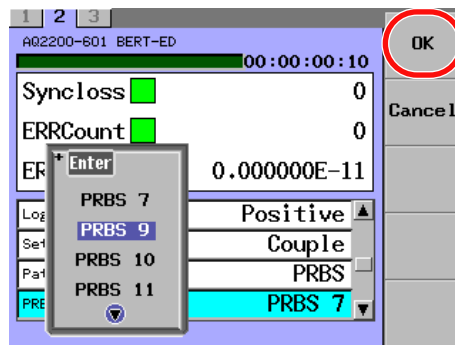

#### Note

- This item becomes valid when PRBS is selected for the Pattern. When the Pattern is set to Prog256, Prog64M, or SDH/SONET, this item is dimmed (shown in gray) and it cannot be selected.
- For an explanation of how to select parameters, see section 2.3.

#### Explanation

When Pattern = PRBS (Pseudo random pattern) is selected, the pattern length of PRBS is set and displayed.

PRBS Length: PRBS7, PRBS9, PRBS10, PRBS11, PRBS15, PRBS23, PRBS31

## Selecting the Program Length (Program Length)

### Procedure

1. Press **DETAIL** to display the DETAIL screen.
2. Use the **SLOT** keys to select the BERT module's ED as the current module.
3. Press the **Short Length** soft key, or move the cursor to Program Length with the arrow keys, and then press the **ENTER**.  
The Program Length dialog box will appear.

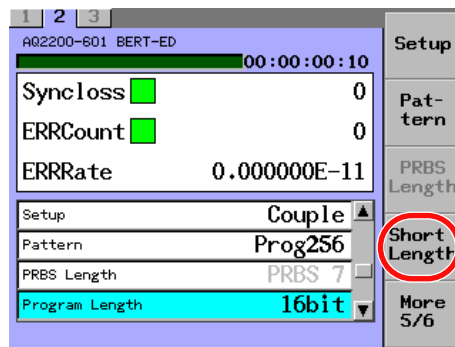

4. Change the numeric value with the numeric keypad or the arrow keys, and then press the **ENTER**.  
The Program Length dialog box will disappear and the set value is then set and displayed.

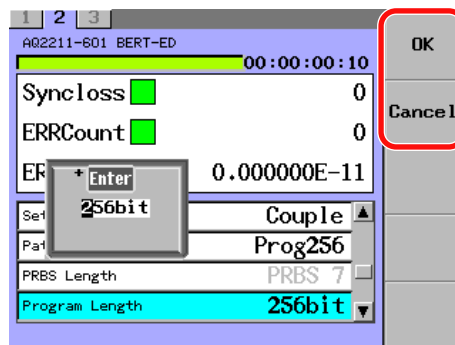

Only valid when a value is changed with the arrow keys

### Note

- This item becomes valid when Prog256 is selected for the Pattern. When the Pattern is set to PRBS, Prog64M, or SDH/SONET, this item is dimmed (shown in gray) and it cannot be selected.
- For an explanation of how to change values, see section 2.3.
- When a value is changed with the arrow keys, you can use the OK and Cancel soft keys.

### Explanation

When Pattern = Prog256 (program pattern) is selected, the bit length of the arbitrary pattern is set and displayed.

Program Length: 16 to 256 bit

Step value: 1 bit

### Selecting the Program Length (Program Length Long)

#### Procedure

1. Press **DETAIL** to display the DETAIL screen.
2. Use the **SLOT** keys to select the BERT module's ED as the current module.
3. Press the **Long Length** soft key, or move the cursor to Program Length (Long) with the arrow keys, and then press the **ENTER**.  
The Program Length (Long) dialog box will appear.

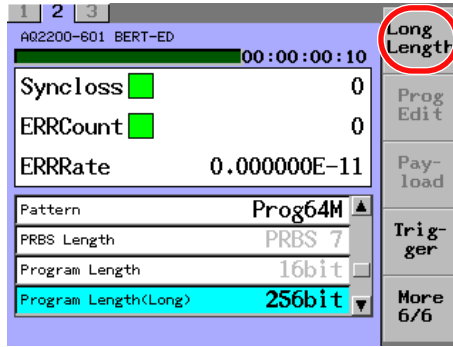

4. Change the numeric value with the numeric keypad or the arrow keys, and then press the **ENTER**.  
The Program Length (Long) dialog box will disappear and the set value is then set and displayed.

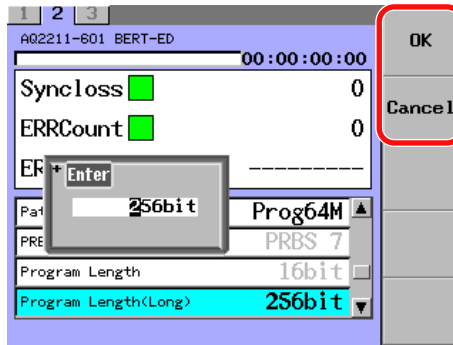

Only valid when a value is changed with the arrow keys

#### Note

- This item is valid on models with the /M option when Pattern is set to Prog64M. When the Pattern is set to PRBS, Prog256, or SDH/SONET, this item is dimmed (shown in gray) and it cannot be selected.
- For an explanation of how to change values, see section 2.3.
- When a value is changed with the arrow keys, you can use the OK and Cancel soft keys.

#### Explanation

When Pattern = Prog64M (program pattern) is selected, the bit length of the arbitrary pattern is set and displayed.  
 Program Length Long: 256 to 671088064 bit  
 Step value: 128 bit



## Editing the Program Pattern (Program Edit)

### Procedure

1. Press **DETAIL** to display the DETAIL screen.
2. Use the **SLOT** keys to select the BERT module's ED as the current module.
3. Press the **Prog Edit** soft key, or move the cursor to Program Edit with the arrow keys, and then press the **ENTER**.

The Program Edit screen will appear at the lower portion of the screen.

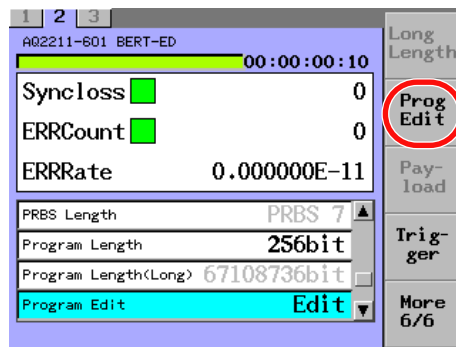

### Selecting the Input Mode

4. Press the **Mode** soft key.  
The Mode dialog box will appear.

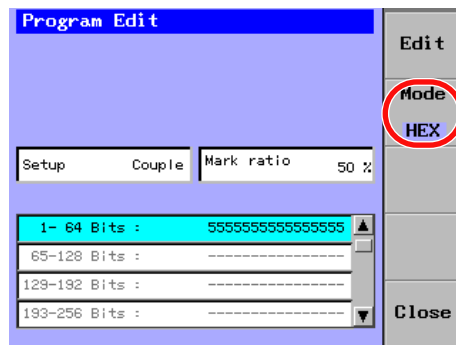

5. With the arrow keys, move the cursor to an item you want to change, and press the **OK** soft key or **ENTER**.

The Mode dialog box will disappear and the item you have selected is then set and displayed.

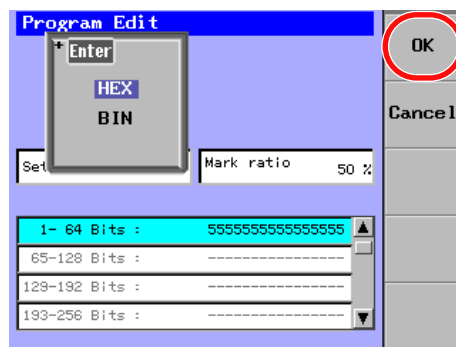

**Editing the Program Pattern**

- Use the arrow keys to move the cursor to the editing area of the program pattern that you want to edit, and press the **Edit** soft key or **ENTER**.

In HEX mode a soft keyboard appears, while in BIN mode a numeric keypad appears.

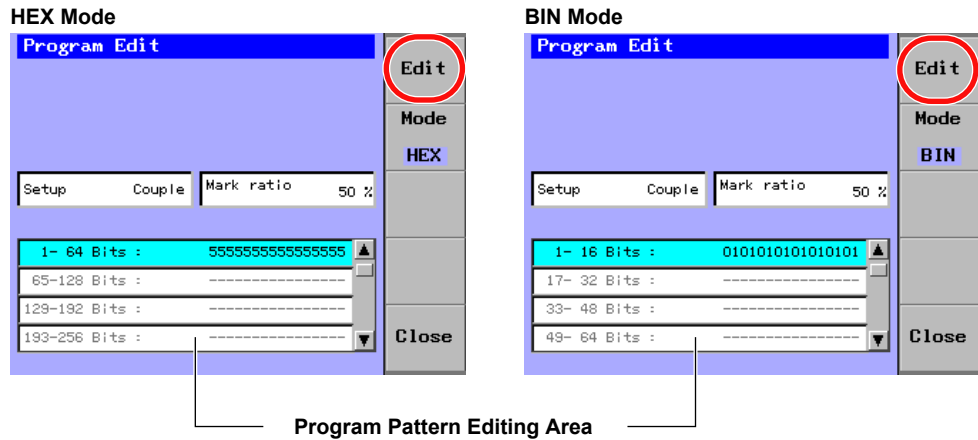

**In HEX Mode**

- Use the soft keyboard to enter text, and press the **Commit** soft key. The data is confirmed and displayed.



- To edit other areas, repeat steps 6 to 7.
- Press the **Close** soft key to close the Program Edit screen.

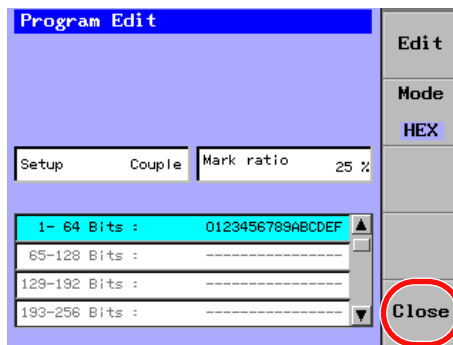

**In BIN Mode**

- Use the numeric keypad to enter a value, and press **ENTER**.  
The data is confirmed and displayed.

- To edit other areas, repeat steps 6 to 7.
- Press the **Close** soft key to close the Program Edit screen.

**Note**

- This item becomes valid when Prog256 is selected for the Pattern. When the Pattern is set to PRBS, Prog64M, or SDH/SONET, this item is dimmed (shown in gray) and it cannot be selected.
- For an explanation of how to change values, see section 2.3. For an explanation of how to enter text, see section 2.4.

**Explanation**

When Pattern = Prog256 (program pattern) is selected, the arbitrary pattern is edited.

- 00 to FF (Hexadecimal notation)
- 0/1 (Binary notation)

## Selecting the Payload Pattern (Payload)

### Procedure

1. Press **DETAIL** to display the DETAIL screen.
2. Use the **SLOT** keys to select the BERT module's ED as the current module.
3. Press the **Payload** soft key, or move the cursor to Payload with the arrow keys, and then press the **ENTER**.

The Payload dialog box will appear.

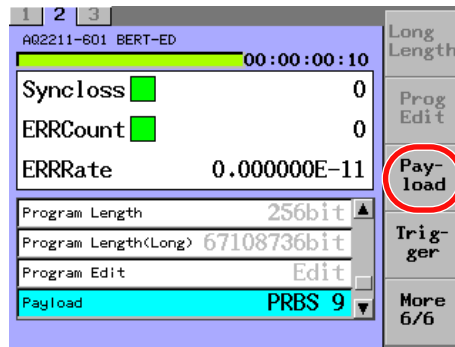

4. With the arrow keys, move the cursor to an item you want to change, and press the **OK** soft key or **ENTER**.

The Payload dialog box will disappear and the item you have selected is then set and displayed.

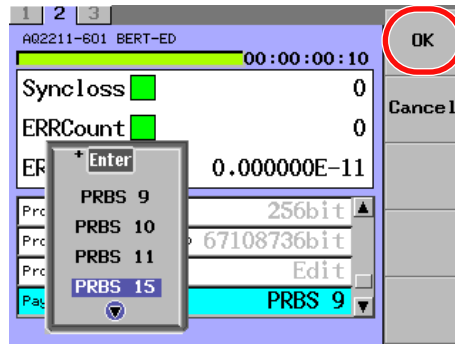

### Note

- This item is valid on models with the /P1 option when Pattern is set to SDH/SONET. When the Pattern is set to PRBS, Prog256, or Prog64M, this item is dimmed (shown in gray) and it cannot be selected.
- For an explanation of how to select parameters, see section 2.3.

### Explanation

When Pattern = SOH/SONET (frame pattern) is selected, the PRBS pattern length of payload is set and displayed.

Payload: PRBS9, PRBS10, PRBS11, PRBS15, PRBS23, PRBS31

## Selecting the Input Data Logic (Logic)

### Procedure

1. Press **DETAIL** to display the DETAIL screen.
2. Use the **SLOT** keys to select the BERT module's ED as the current module.
3. Press the **Logic** soft key, or move the cursor to Logic with the arrow keys, and then press the **ENTER**.

The Logic dialog box will appear.

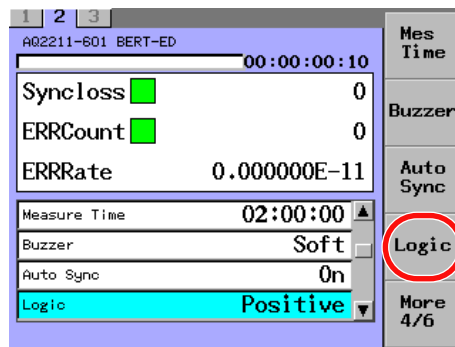

4. With the arrow keys, move the cursor to an item you want to change, and press the **OK** soft key or **ENTER**.

The Logic dialog box will disappear and the item you have selected is then set and displayed.

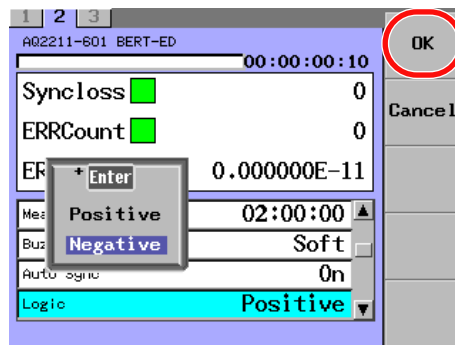

### Note

For an explanation of how to select parameters, see section 2.3.

### Explanation

Whether the ED data input signal is the positive logic or negative logic is set and displayed.

- Positive: The positive logic is input to the data input terminal.
- Negative: The negative logic is input to the data input terminal.

### Displaying the Measurement Results (Result Disp)

#### Procedure

1. Press **DETAIL** to display the DETAIL screen.
2. Use the **SLOT** keys to select the BERT module's ED as the current module.
3. Press the **Result Disp** soft key.  
The measured results display will appear at the lower portion of the screen.

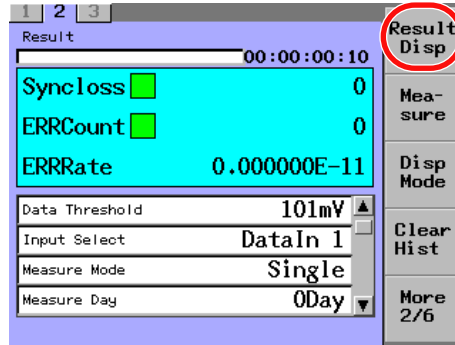

4. Press the **Close** soft key to close the measured results display.

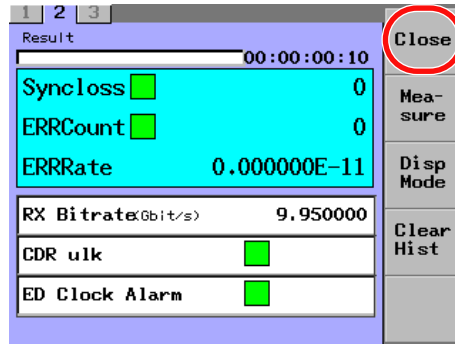

#### Note

The Result Disp can be operated only with the soft key.

#### Explanation

Displays the measured results.

- Rx Bitrate: Shows the receive bitrate of the ED using the numeric value.
- CDR ulk: Shows the operation status of the CDR function of the ED using the indicators.
- ED Clock Alarm: Shows the receive clock status of the ED using the indicators.

For details, see page 9-5.

## Selecting the Timing to Update the Screen (Disp Mode)

### Procedure

1. Press **DETAIL** to display the DETAIL screen.
2. Use the **SLOT** keys to select the BERT module's ED as the current module.
3. Press the **Disp Mode** soft key.  
The Disp Mode dialog box will appear.

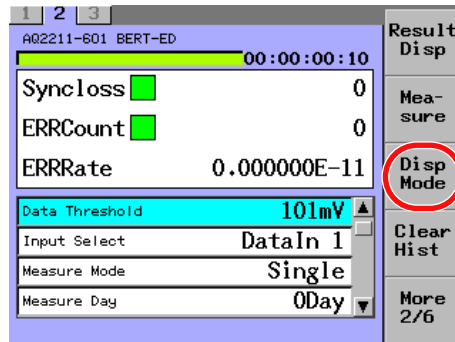

4. With the arrow keys, move the cursor to an item you want to change, and press the **OK** soft key or **ENTER**.  
The Disp Mode dialog box will disappear and the item you have selected is then set and displayed.

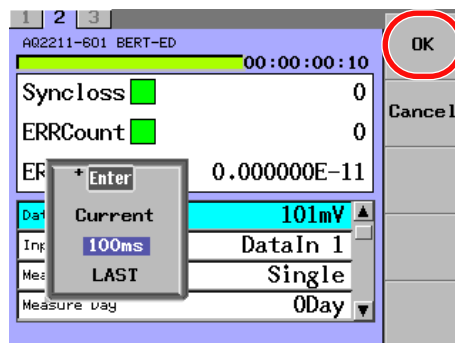

### Note

- The Disp Mode can be operated only with the soft key.
- Last is valid when Measure Mode is set to Repeat.
- For an explanation of how to select parameters, see section 2.3.

### Explanation

The timing to update the screen is set and displayed.

- Current: Shows the value accumulated from the start of measurement in real time.
- 100ms: Shows the value measured for 100ms at intervals of 100ms.
- Last: Shows the value for one cycle until the measurement for the next cycle completes.

### Clearing the Measurement History (Clear Hist)

#### Procedure

1. Press **DETAIL** to display the DETAIL screen.
2. Use the **SLOT** keys to select the BERT module's ED as the current module.
3. Press the **Clear Hist** soft key.  
The measurement history is cleared.

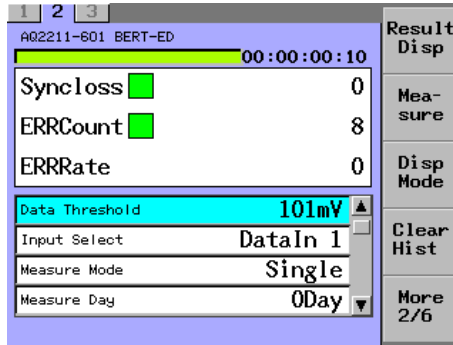
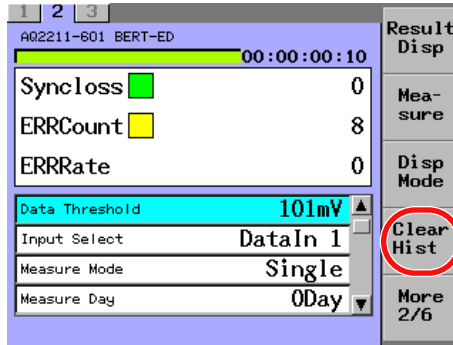

#### Note

The Clear Hist can be operated only with the soft key.

#### Explanation

Clears the alarm and error measurement history and returns the indicator to its normal condition (green). Even if you execute Clear Hist, the measured results (values) are not cleared.

For details, see page 9-4.



## Starting or Stopping the BER Measurement (Measure)

### Procedure

1. Press **DETAIL** to display the DETAIL screen.
2. Use the **SLOT** keys to select the BERT module's ED as the current module.
3. Press the **Measure** soft key.  
The Measure dialog box will appear.

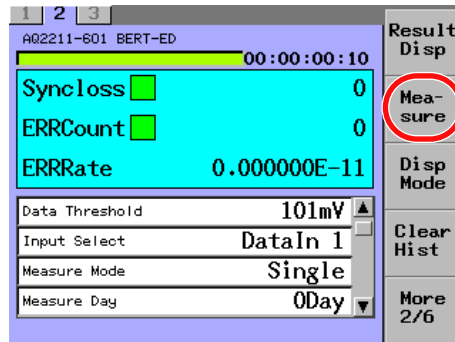

4. With the arrow keys, move the cursor to an item you want to change, and press the **OK** soft key or **ENTER**.  
The Measure dialog box closes, and BER measurement starts or stops.

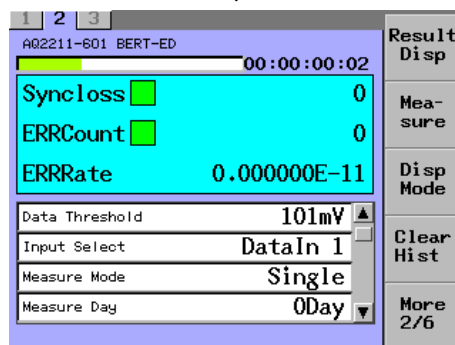
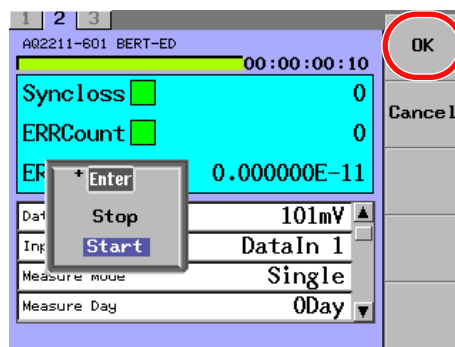

### Note

- The Measure can be operated only with the soft key.
- If you press Start during the BER measurement, the BER measurement will restart.
- If any of the following ED setting items is changed or reset during a BER measurement, the BER measurement will restart:  
Mes Mode, Mes Day, Mes Time, Pattern, PRBS Length, Program Length, Program Edit, Payload.
- For an explanation of how to select parameters, see section 2.3.

### **Explanation**

The measurement is started or stopped.

- Start: Starts the measurement.
- Stop: Stops the measurement.

## SG Setting

### Setting the Bitrate (Bitrate)

#### Procedure

1. Press **DETAIL** to display the DETAIL screen.
2. Use the **SLOT** keys to select the BERT module's SG as the current module.
3. Press the **Bitrate** soft key, or move the cursor to Bitrate with the arrow keys, and then press the **ENTER**.

The Bitrate dialog box will appear.

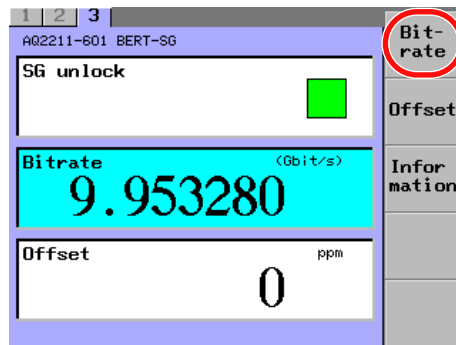

4. Change the numeric value with the numeric keypad or the arrow keys, and then press the **ENTER**.

The Bitrate dialog box will disappear and the set value is then set and displayed.

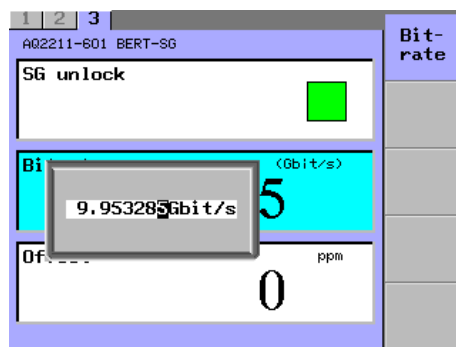

#### Note

For an explanation of how to change values, see section 2.3.

#### Explanation

The bitrate of the built-in SG clock is set and displayed.

If the bitrate is changed, the frequency sync loss of the SG may occur instantaneously. If the sync loss occurs, the frequency may deviate largely.

Bitrate: 9.950000 to 11.320000 Gbit/s

Step value: 0.000001 Gbit/s

### Setting the Bitrate Offset (Offset)

#### Procedure

1. Press **DETAIL** to display the DETAIL screen.
2. Use the **SLOT** keys to select the BERT module's SG as the current module.
3. Press the **Offset** soft key, or move the cursor to Offset with the arrow keys, and then press the **ENTER**.  
The Offset dialog box will appear.

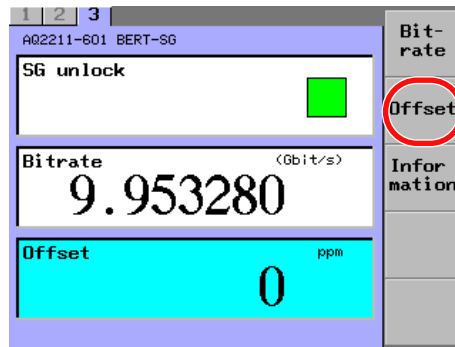

4. Change the numeric value with the numeric keypad or the arrow keys, and then press the **ENTER**.  
The Offset dialog box will disappear and the set value is then set and displayed.

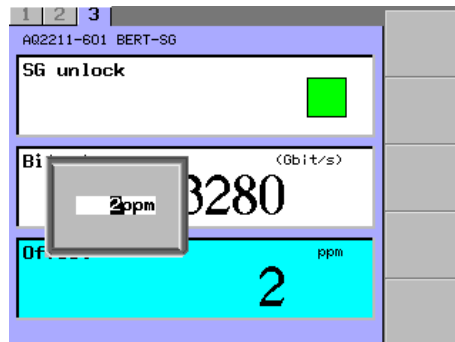

#### Note

For an explanation of how to change values, see section 2.3.

#### Explanation

The frequency displacement amount from the set bitrate is set and displayed in units of ppm.

Offset: -100 to 100 ppm

Step value: 1 ppm

## 9.3 10 Gbit/s Optical Modulator Module

### Display Screen

This section describes the display contents of the SUMMARY screen and DETAIL screen.

#### SUMMARY Screen

AQ2212 FRAME CONTROLLER			
1	Signal Output	On	Driver Gain
2	Input Select	Data In	Cross Point
3	SG unlock	1	ABC Slope
4	Driver Gain	180	ABC Reset
5	Data Threshold	0	More 2/2
6	NO MODULE		
7	NO MODULE		
8	NO MODULE		
9	NO MODULE		

#### Driver Gain

Shows the output amplitude setting of the internal LN driver.  
Display range: 0 to 255

#### Cross Point

Shows the cross point setting of the internal LN driver output waveform using the numeric value and graph.  
Display range: -31 to 32

#### DETAIL Screen

AQ2200-622 E/O MODULE	
Driver Gain	150
Cross Point	0
ABC Slope	Positive
Auto Bias Ctrl	On
LN Bias Set	0.00V
Alarm	TEMP <input checked="" type="checkbox"/> ABC <input checked="" type="checkbox"/>

#### Driver Gain

Shows the output amplitude setting of the internal LN driver using the numeric value and graph.  
Display range: 0 to 255

#### Cross Point

Shows the cross point setting of the internal LN driver output waveform using the numeric value and graph.  
Display range: -31 to 32

#### ABC Slope

Shows the Slope setting status of the ABC.  
This item is displayed when the ABC is set at ON.

#### Auto Bias Ctrl

Shows the ON/OFF status of the ABC.

#### LN Bias Set

Shows the DC bias voltage of the LN modulator.  
This item is displayed when the ABC is set at OFF.  
Display range: -10.00 to 9.90 V

#### Alarm

The alarm status of the module is detected and it is shown.

#### • TEMP

Shows the temperature alarm.

Indication	Description
Red	The thermistor driver detected a temperature error. Since the component may be broken thermally in this status, the power supply from the frame to the module is automatically stopped. Immediately stop the operation and lower the ambient temperature.
Yellow	The temperature inside the module is too high. If the operation is continued, this may cause operation fault.
Green	Correct status

#### • ABC

Shows the status of the auto bias control (Auto Bias Control) circuit of the LN modulator.

Indication	Status
Green	Correct
Red	Fault

**Screen Configuration Diagram**

Screen Name (Tab)	Setup Item	Set Value
Optical Modulator	Driver Gain	0 to 255
	Cross Point	-31 to 32
	ABC Slope	Positive, Negative
	Auto Bias Ctrl [ABC Enable] <sup>1</sup>	On, Off
	LN Bias (Set) <sup>2</sup>	-10.00 to 9.90 [V]
	*ABC Reset	
	*Information	
	*Module Preset	

- \* Operated only with soft key.
- 1 Soft key is shown in [ ].
- 2 Soft key is shown with the word(s) in ( ) omitted.

**Soft Key Menu**

Name	Function
Driver Gain	The output amplitude setting of the internal LN driver output waveform and set value are displayed using the numeric values and graphs.
Cross Point	The cross point setting of the internal LN driver and set value are displayed using the numeric values and graphs.
ABC Slope	The polarity of the DC bias point of the LN modulator is set and displayed when the Auto Bias Control (ABC) is made valid.
ABC Enable	Whether or not the auto bias control (ABC: Auto Bias Control) circuit is operated to automatically correct the DC drift of the LN modulator is set.
LN Bias	The DC bias of the LN modulator is set manually.
ABC Reset	The ABC alarm is reset.
Information	The type and version information of the optical modulator are displayed.
Module Preset	Each set value is returned to that set at shipment of the factory.

## Setting the Gain of The Driver for the Optical Modulator (Driver Gain)

### Procedure

1. Press **DETAIL** to display the DETAIL screen.
2. Use the **SLOT** keys to select the Optical Modulator module as the current module.
3. Press the **Driver Gain** soft key, or move the cursor to Driver Gain with the arrow keys, and then press the **ENTER**.  
The Driver Gain dialog box will appear.

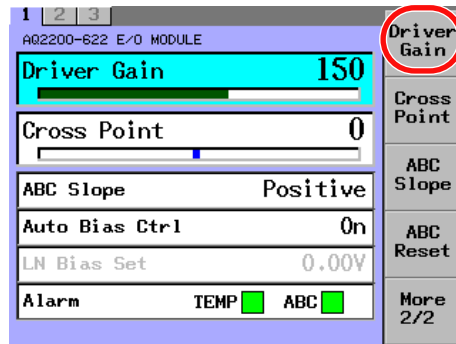

4. Change the numeric value with the numeric keypad or the arrow keys, and then press the **ENTER**.  
The Driver Gain dialog box will disappear and the set value is then set and displayed.

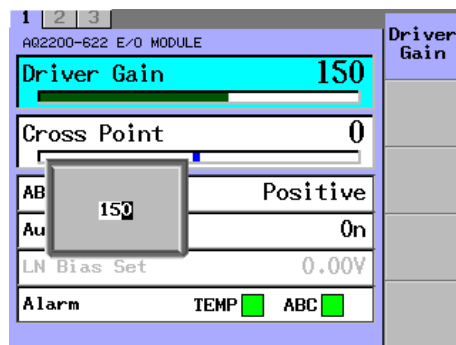

### Note

For an explanation of how to change values, see section 2.3.

### Explanation

The output amplitude of the optical modulator driver is set and displayed.  
Driver Gain: 0 to 255, 1 step

### 9.3 10 Gbit/s Optical Modulator Module

---

The following shows the relationship between the numeric value and graph display of the driver gain.

- Driver Gain is "0".

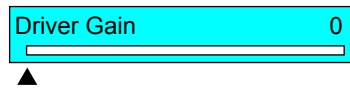

- Driver Gain is "150".

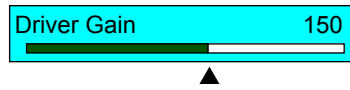

- Driver Gain is "255".

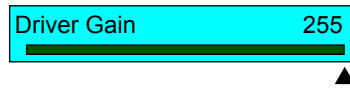



### Setting the Cross Point of the Driver for the Optical Modulator (Cross Point)

#### Procedure

1. Press **DETAIL** to display the DETAIL screen.
2. Use the **SLOT** keys to select the Optical Modulator module as the current module.
3. Press the **Cross Point** soft key, or move the cursor to Cross Point with the arrow keys, and then press the **ENTER**.  
The Cross Point dialog box will appear.

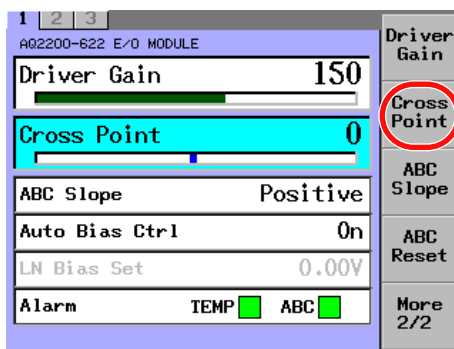

4. Change the numeric value with the numeric keypad or the arrow keys, and then press the **ENTER**.  
The Cross Point dialog box will disappear and the set value is then set and displayed.

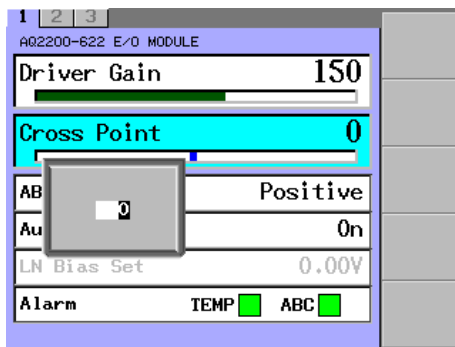

#### Note

For an explanation of how to change values, see section 2.3.

#### Explanation

The cross point of the optical modulator driver is set and displayed.  
Cross Point: -31 to 32, 1 step

### 9.3 10 Gbit/s Optical Modulator Module

---

The following shows the relationship between the numeric value and graph display of the cross point.

- Cross Point is “-31”.

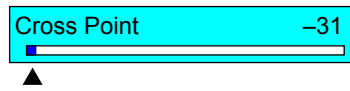

- Cross Point is “0”.

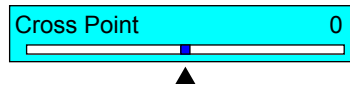

- Cross Point is “32”.

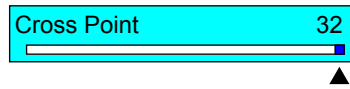

## Selecting the ABC Slope (ABC Slope)

### Procedure

1. Press **DETAIL** to display the DETAIL screen.
2. Use the **SLOT** keys to select the Optical Modulator module as the current module.
3. Press the **ABC Slope** soft key, or move the cursor to ABC Slope with the arrow keys, and then press the **ENTER**.  
The ABC Slope dialog box will appear.

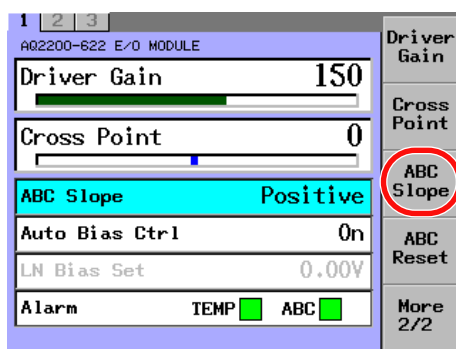

4. With the arrow keys, move the cursor to an item you want to change, and press the **OK** soft key or **ENTER**.  
The ABC Slope dialog box will disappear and the item you have selected is then set and displayed.

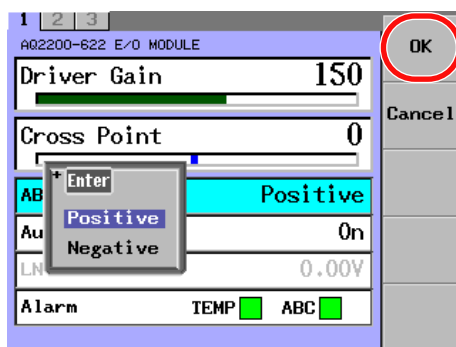

### Note

- This item becomes valid when ON is selected for the Auto Bias Ctrl. When the Auto Bias Ctrl is set to OFF, this item is dimmed (shown in gray) and it cannot be selected.
- For an explanation of how to select parameters, see section 2.3.

### Explanation

The ABC slope status of the optical modulator is set and displayed.

ABC Slope

- Positive: ABC is locked on the Positive side.
- Negative: ABC is locked on the Negative side.

### Resetting the ABC Alarm (ABC Reset)

#### Procedure

1. Press **DETAIL** to display the DETAIL screen.
2. Use the **SLOT** keys to select the Optical Modulator module as the current module.
3. Press the **ABC Reset** soft key.  
The ABC Reset dialog box will appear.

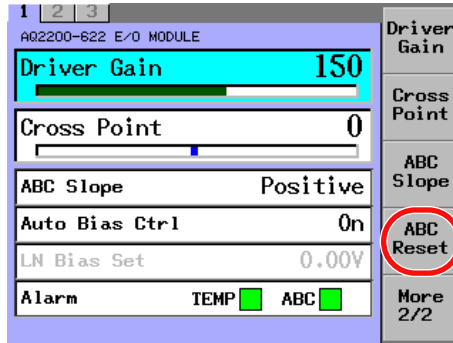

4. To reset the ABC, press the **OK** soft key or **ENTER**.  
The ABC Reset dialog box will disappear and the ABC is then reset.

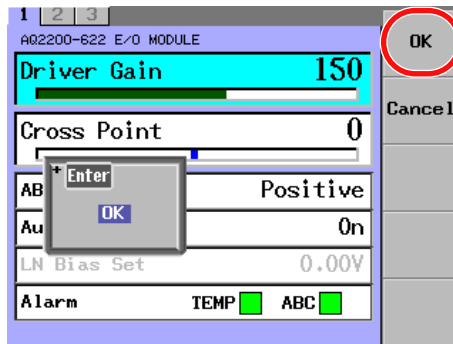

#### Note

- The ABC Reset (ABC reset) can be operated only with the soft key.
- For an explanation of how to select parameters, see section 2.3.

#### Explanation

The ABC Alarm is kept in red if the ABC alarm is detected even only once after the ABC Reset has been executed.

## Making the ABC Enabled (Auto Bias Control)

### Procedure

1. Press **DETAIL** to display the DETAIL screen.
2. Use the **SLOT** keys to select the Optical Modulator module as the current module.
3. Press the **ABC Enable** soft key, or move the cursor to Auto Bias Ctrl with the arrow keys, and then press the **ENTER**.  
The Auto Bias Ctrl dialog box will appear.

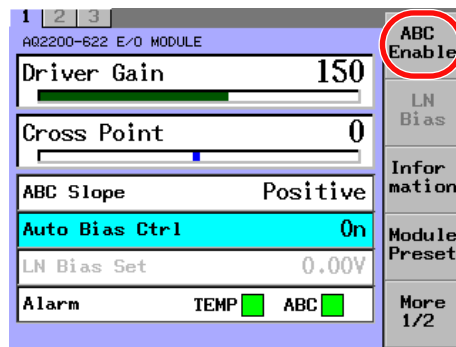

4. With the arrow keys, move the cursor to an item you want to change, and press the **OK** soft key or **ENTER**.  
The Auto Bias Ctrl dialog box will disappear and the item you have selected is then set and displayed.

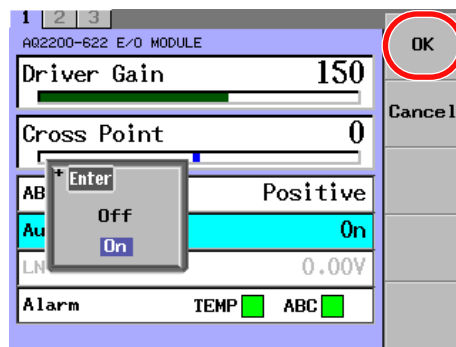

### Note

- When the Auto Bias Ctrl is set at OFF, the manual bias setup (LN Bias Set) becomes valid.
- For an explanation of how to select parameters, see section 2.3.

### Explanation

Whether or not the auto bias control (ABC) of the optical modulator is used is set and displayed.

Auto Bias Ctrl

- On: ABC is used (enabled).
- Off: ABC is not used (disabled).

### Setting the Bias Manually (LN Bias Set)

#### Procedure

1. Press **DETAIL** to display the DETAIL screen.
2. Use the **SLOT** keys to select the Optical Modulator module as the current module.
3. Press the **LN Bias Set** soft key, or move the cursor to LN Bias Set with the arrow keys, and then press the **ENTER**.  
The LN Bias Set dialog box will appear.

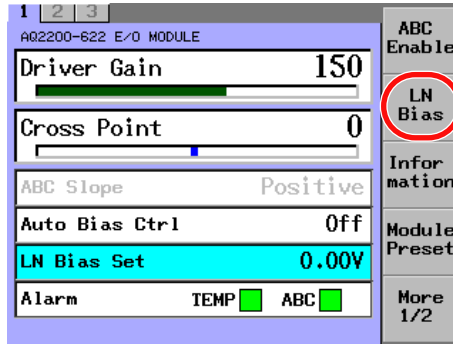

4. Change the numeric value with the numeric keypad or the arrow keys, and then press the **ENTER**.  
The LN Bias Set dialog box will disappear and the set value is then set and displayed.

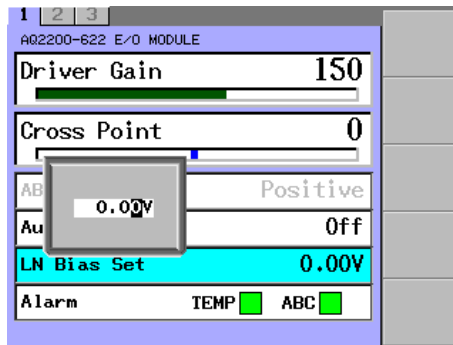

#### Note

- This item becomes valid when OFF is selected for the Auto Bias Ctrl.  
When the Auto Bias Ctrl is set to ON, this item is dimmed (shown in gray) and it cannot be selected.  
When the Auto Bias Ctrl is changed from OFF to ON, the values, which have been set when the Auto Bias Ctrl has been set at OFF, will be lost (cleared).
- For an explanation of how to change values, see section 2.3.

#### Explanation

The DC bias voltage of the optical modulator is manually set and displayed.

LN Bias Set: -10.00 to 9.90 V, 0.01 V step

## Returning to the Factory Default Settings (Module Preset)

### Procedure

1. Press **DETAIL** to display the DETAIL screen.
2. Use the **SLOT** keys to select the Optical Modulator module as the current module.
3. Press the **Module Preset** soft key.  
The Module Preset dialog box will appear.

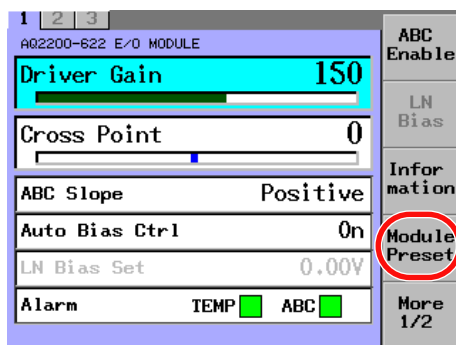

4. Press the **OK** soft key or **ENTER**.  
The Module Preset dialog box will disappear, and then the Optical Modulator module is returned to its factory default settings.

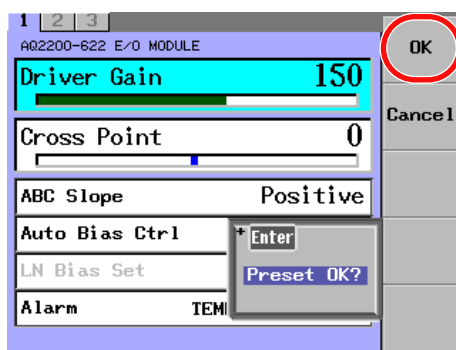

### Note

- The Module Preset (factory default setting) can be operated only with the soft key.
- For an explanation of how to select parameters, see section 2.3.

### Explanation

Returns the module to its factory default settings.  
For details about factory default setting (initial setting) values, see the “List of Default Settings” (page 13-28).

## 9.4 10 Gbit/s Optical Receiver Module

### Display Screen

This section describes the display contents of the SUMMARY screen and DETAIL screen.

#### SUMMARY Screen

A02212 FRAME CONTROLLER			
1	Signal Output	On	Data Amplitude 0.50Vpp
2	Input Select	Data I	Err-rate -----
3	SG unlock	<input checked="" type="checkbox"/>	Bitrate (Gbit/s) 9.953280
4	Driver Gain	180	Cross Point 0
5	Data Threshold	0	Input Power - 0.5 dBm
6	NO MODULE		
7	NO MODULE		
8	NO MODULE		
9	NO MODULE		

#### Data Threshold

Shows the threshold value setting for identification of the logic to the electric data after completion of the optical-electric conversion.  
Display range: -364 to 273

#### Input Power

Shows the average optical input power.  
Measurement range: -19.0 dBm to +3.0 dBm

Input Status	Display
Within measurement range	-19.0 dBm to +3.0 dBm
Beyond measurement range	<-19 dBm >+3 dBm

Note that the sensitivity correction by the temperature and waveform length is not made.



DETAIL Screen

**Data Threshold**  
Shows the threshold value setting for identification of the logic to the electric data after completion of the optical-electric conversion.  
Display range: -364 to 273

**Data Output**  
Shows the output port status.

**Input Power**  
Shows the average optical input power.  
Measurement range: -19.0 dBm to +3.0 dBm  
(accuracy: ±1 dB)

Input Status	Display
Within measurement range	-19.0 dBm to +3.0 dBm
Beyond measurement range	<-19 dBm >+3 dBm

Note that the sensitivity correction by the temperature and waveform length is not made.

**Wavelength**  
Shows the wavelength band of the receiving light signal.  
1.5 μm or 1.3 μm

**Overload Point**  
Shows the Overload detection level.  
-19.0 dBm to +2.0 dBm

**Los Point**  
Shows the Los detection level.  
-19.0 dBm to +2.0 dBm

Alarm

Detects the alarm status of the module to indicate it.

• TEMP

Shows the temperature alarm.

Indication	Description
Red	The thermistor driver detected a temperature error. Since the component may be broken thermally in this status, the power supply from the frame to the module is automatically stopped. Immediately stop the operation and lower the ambient temperature.
Yellow	The temperature inside the module is too high. If the operation is continued, this may cause operation fault.
Green	Correct status

• OVER 1,2

Monitors the average power of the optical input. If the average power exceeds the Overload level, the LED (red) is lit. (Detection accuracy: ±1 dB)

Indication	Status
Green	Correct status
Red	Overload status

• LOS (Loss of Signal) 1,2

Monitors the average power of the optical input. If the average power is less than the LOS level, the LED (red) is lit. (Detection accuracy: ±1 dB)

Indication	Status
Green	Correct status
Red	LOS status

1 Since the bit error is not detected, the bit error does not always occur even though the alarm LED is lit in red.  
2 The alarm indication is interlocked with the LED on the front panel.

**Screen Configuration Diagram**

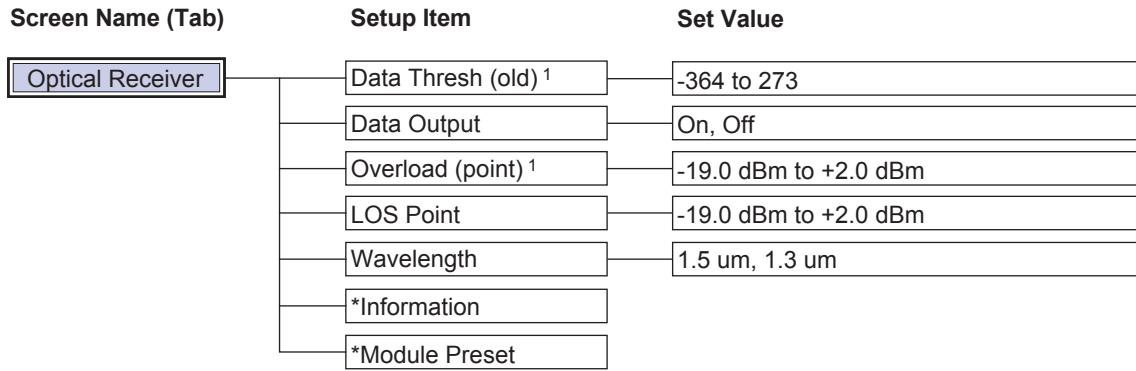

\* Operated only with soft key.

<sup>1</sup> Soft key is shown with the word(s) in ( ) omitted.

**Soft Key Menu**

Name	Function
Data Thresh(old)	The threshold value for identification of the logic to the electric data after completion of the optical-electric conversion is set.
Data Output	The DATA OUT port (electric output) is turned ON or OFF.
Overload (point)	The Overload detection level is set.
LOS Point	The LOS (Loss of signal) detection level is set.
Wavelength	The wavelength band of the receiving light signal is set.
Information	The type and version information of the optical receiver are displayed.
Module Preset	Each set value is returned to that set at shipment of the factory.

## Setting the Data Threshold Value (Data Threshold)

### Procedure

1. Press **DETAIL** to display the DETAIL screen.
2. Use the **SLOT** keys to select the Optical Receiver module as the current module.
3. Press the **Data Thresh** soft key, or move the cursor to Data Threshold with the arrow keys, and then press the **ENTER**.  
The Data Threshold dialog box will appear.

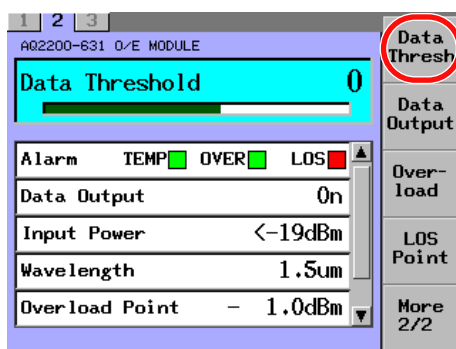

4. Change the numeric value with the numeric keypad or the arrow keys, and then press the **ENTER**.  
The Data Threshold dialog box will disappear and the set value is then set and displayed.

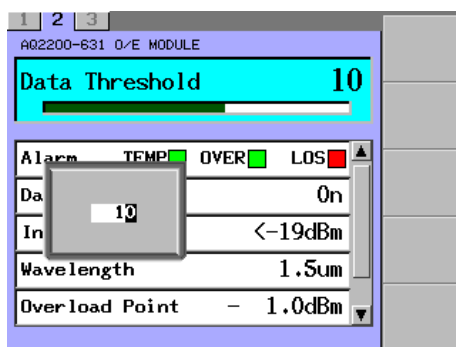

### Note

For an explanation of how to change values, see section 2.3.

### Explanation

The threshold value for identification of the logic to the electric data after completion of the optical-electric conversion is set and displayed.

Data Threshold: -364 to 273, 1 step

## 9.4 10 Gbit/s Optical Receiver Module

---

The following shows the relationship between the numeric value and graph display of the data threshold.

- Data threshold is “-364”.

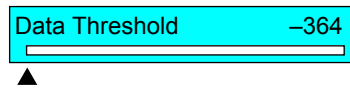

- Data threshold is “0”.

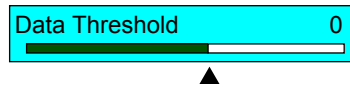

- Data threshold is “273”.

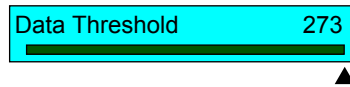

## Turning ON or OFF the Data Output (Data Output)

## Procedure

1. Press **DETAIL** to display the DETAIL screen.
2. Use the **SLOT** keys to select the Optical Receiver module as the current module.
3. Press the **Data Output** soft key, or move the cursor to Data Output with the arrow keys, and then press the **ENTER**.  
The Data Output dialog box will appear.

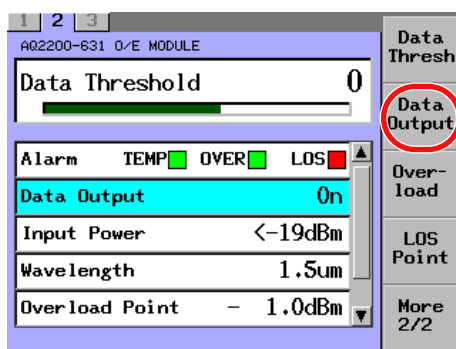

4. With the arrow keys, move the cursor to either On or Off, and press the **OK** soft key or **ENTER**.  
The Data Output dialog box will disappear and the item you have selected is then set and displayed.

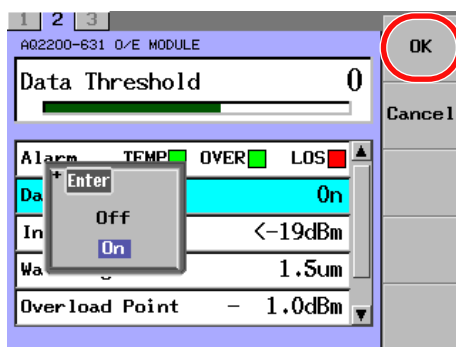
**Note**

For an explanation of how to select parameters, see section 2.3.

## Explanation

The ON/OFF status of the data output of the DATA OUT port is set and displayed.

Data output

- On: Data is being output.
- Off: Data output is stopped.

### Setting the Overload Detection Level (Overload Point)

#### Procedure

1. Press **DETAIL** to display the DETAIL screen.
2. Use the **SLOT** keys to select the Optical Receiver module as the current module.
3. Press the **Overload** soft key, or move the cursor to Overload Point with the arrow keys, and then press the **ENTER**.  
The Overload Point dialog box will appear.

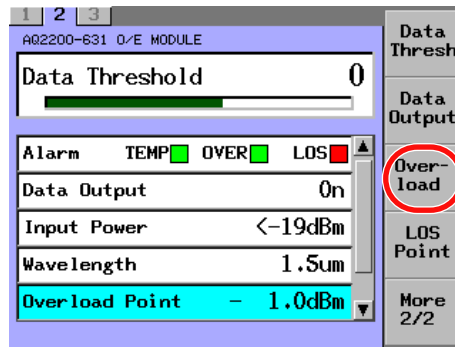

4. Change the numeric value with the numeric keypad or the arrow keys, and then press the **ENTER**.  
The Overload Point dialog box will disappear and the set value is then set and displayed.

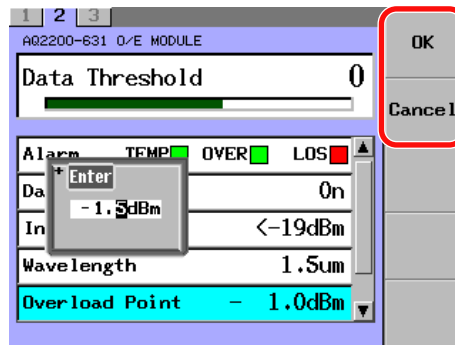

Only valid when a value is changed with the arrow keys

#### Note

- If an optical signal exceeding the detection level set in Overload point is input, the OVER LED (red) on the panel is lit and the OVER indicator of the Alarm is changed to the red indication.
- For an explanation of how to change values, see section 2.3.
- When a value is changed with the arrow keys, you can use the OK and Cancel soft keys.

#### Explanation

The OVERLOAD detection level is set and displayed.

Overload Point: -19.0 to +2.0 dBm, 0.1 dBm step

## Setting the Loss Detection Level (LOS Point)

### Procedure

1. Press **DETAIL** to display the DETAIL screen.
2. Use the **SLOT** keys to select the Optical Receiver module as the current module.
3. Press the **LOS Point** soft key, or move the cursor to LOS Point with the arrow keys, and then press the **ENTER**.  
The LOS Point dialog box will appear.

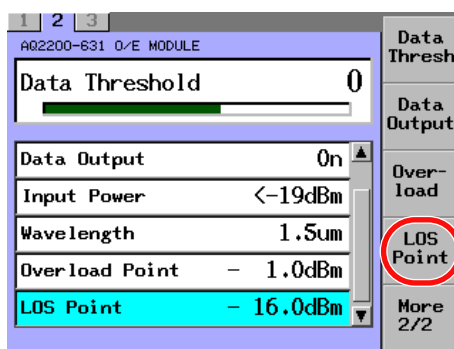

4. Change the numeric value with the numeric keypad or the arrow keys, and then press the **ENTER**.  
The LOS Point dialog box will disappear and the set value is then set and displayed.

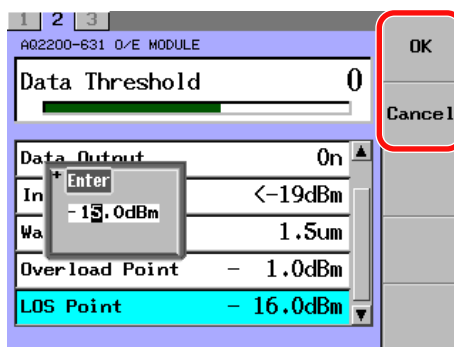

Only valid when a value is changed with the arrow keys

### Note

- If an optical signal below the detection level set in Overload point is input, the OVER LED (red) on the panel is lit and the OVER indicator of the Alarm is changed to the red indication.
- For an explanation of how to change values, see section 2.3.
- When a value is changed with the arrow keys, you can use the OK and Cancel soft keys.

### Explanation

The LOS (Loss of signal) detection level is set and displayed.

Los point: -19.0 to +2.0 dBm, 0.1 dBm step

### Selecting the Wavelength Band of the Receiving Light Signal (Wavelength)

#### Procedure

1. Press **DETAIL** to display the DETAIL screen.
2. Use the **SLOT** keys to select the Optical Receiver module as the current module.
3. Press the **Wavelength** soft key, or move the cursor to Wavelength with the arrow keys, and then press the **ENTER**.  
The Wavelength dialog box will appear.

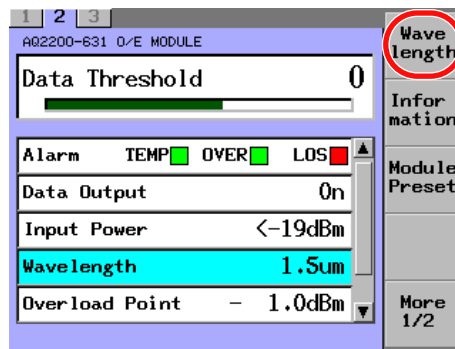

4. With the arrow keys, move the cursor to either 1.5um or 1.3um, and press the **OK** soft key or **ENTER**.  
The Wavelength dialog box will disappear and the item you have selected is then set and displayed.

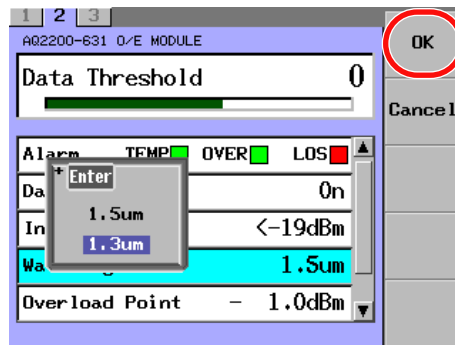

#### Note

For an explanation of how to select parameters, see section 2.3.

#### Explanation

The wavelength band of the receiving light is set and displayed.

By setting the wavelength band, the wavelength of the simple power monitor (Received Power) is corrected easily.

The wavelength is not corrected within the wavelength band.

Wavelength

- 1.5  $\mu\text{m}$ : When the wavelength of the receiving light is 1.5  $\mu\text{m}$ -band
- 1.3  $\mu\text{m}$ : When the wavelength of the receiving light is 1.3  $\mu\text{m}$ -band



## Returning to the Factory Default Settings (Module Preset)

### Procedure

1. Press **DETAIL** to display the DETAIL screen.
2. Use the **SLOT** keys to select the Optical Receiver module as the current module.
3. Press the **Module Preset** soft key.  
The Module Preset dialog box will appear.

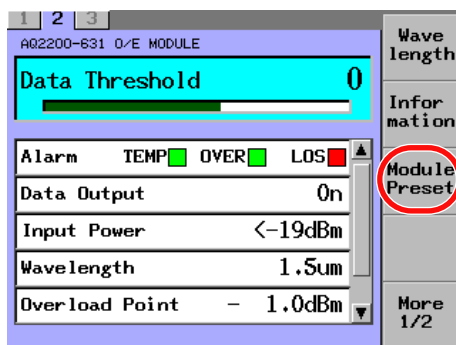

4. Press the **OK** soft key or **ENTER**.  
The Module Preset dialog box will disappear, and then the Optical Receiver module is returned to its factory default settings.

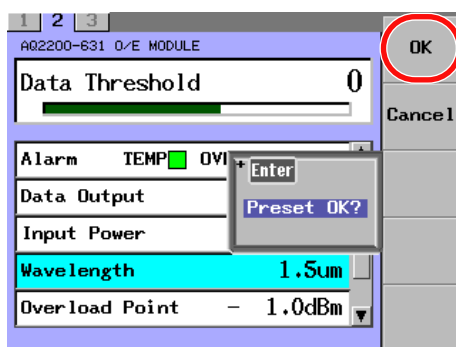

### Note

- The Module Preset (factory default setting) can be operated only with the soft key.
- For an explanation of how to select parameters, see section 2.3.

### Explanation

Returns the module to its factory default settings.  
For details about factory default setting (initial setting) values, see the "List of Default Settings" (page 13-28).

# 10.1 SG Module

## Display Screen

This section describes the display contents of the SUMMARY screen and DETAIL screen.

### SUMMARY Screen

#### 3-Slot Type

**Output**  
Shows the clock signal output status.

**Frequency**  
Shows the clock signal frequency.

**Output CH**  
When Output is ON, the channels from which clock signals are transmitted are displayed in green.

#### 9-Slot Type

**Output**  
Shows the clock signal output status.

**Frequency**  
Shows the clock signal frequency.

**Output CH**  
When Output is ON, the channels from which clock signals are transmitted are displayed in green.

### DETAIL Screen

**Output**  
Shows the clock signal output status.

**Frequency**  
Shows the clock signal frequency.

**Output CH**  
When Output is ON, the channels from which clock signals are transmitted are displayed in green.

**Alarm**  
Shows the PLL (phase lock loop) lock status.

**Indication Status**

Green	The PLL is locked. A clock signal with the specified frequency is transmitted.
Red	The PLL is unlocked. The clock signal frequency is not fixed. The PLL is also unlocked when External is selected as the reference sync signal (Ref) and an appropriate signal is not being applied to the 10 MHz REF IN terminal.

Shows the values set on the SG module.

**Soft Key Menu**

Name	Function
Output	Turns the clock signal output (RF OUT) ON or OFF
Output Select	Enables or disables the clock signal (RF OUT) output channels (1 to 5)
FREQ	Sets the clock signal (RF OUT) frequency
Offset	Sets the clock signal (RF OUT) frequency offset
Amp	Sets the clock signal (RF OUT) amplitude
Rate	Sets the clock signal (RF OUT) rate (1/1, 1/4)
Ref	Sets the sync reference signal (Internal, 10MHz REF IN)
Information	Shows the version information of the SG module
Module Preset	Initializes the SG module

**Turning Clock Signal Output (RF OUT) ON/OFF (Output)**

**Procedure**

There are two ways to turn clock signal output ON and OFF. Pick the method that is most appropriate for your situation.

To turn clock signal output ON or OFF, follow the procedure below.

When clock signal output is ON, the OUTPUT LED on the front panel of the SG module is lit.

**Making Settings from the SG Module**

Press the **OUTPUT** key on the panel to switch the module ON and OFF.

**Making Settings from the Frame Controller Panel**

1. Press **DETAIL** to display the DETAIL screen.
2. Use the **SLOT** keys to select the SG module as the current module.
3. Press the **Output** soft key, or use the arrow keys to move the cursor to Output and press **ENTER**.

A dialog box for turning the signal output on and off appears.

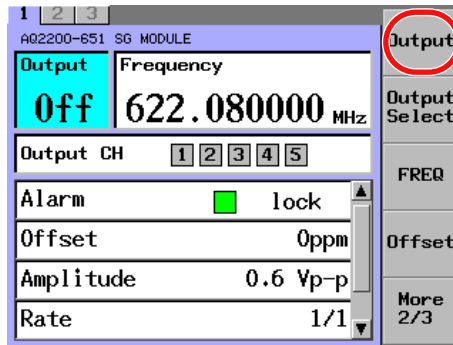

- Use the arrow keys to move the cursor to On or Off, and press the **OK** soft key or **ENTER**.

The dialog box disappears, and the selected item is confirmed and displayed.

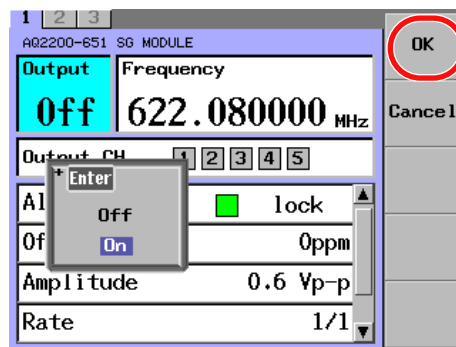

### Note

- For an explanation of how to select parameters, see section 2.3.
- If all of the clock signal (RF OUT) output channels (1 to 5) are set to Disable, the clock signal will not be transmitted even when Output is set to On.

### Explanation

Turn the clock signal output (RF OUT) ON or OFF.

- On: Signal transmission occurs.
- Off: Signal transmission is stopped.

## Enabling or Disabling (Output Select) the Clock Signal (RF OUT) Output Channels (1 to 5)

### Procedure

1. Press **DETAIL** to display the DETAIL screen.
2. Use the **SLOT** keys to select the SG module as the current module.
3. Press the **Output Select** soft key, or use the arrow keys to move the cursor to Output CH and press **ENTER**.  
The Output Select dialog box appears.

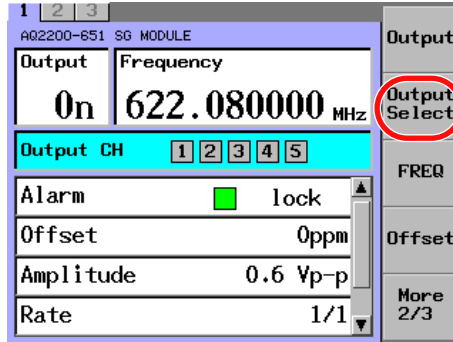

4. Use the arrow keys to move the cursor to the channel (1 to 5) that you want to set, and press **ENTER**.  
The setting switches between Enable and Disable each time you press **ENTER**.

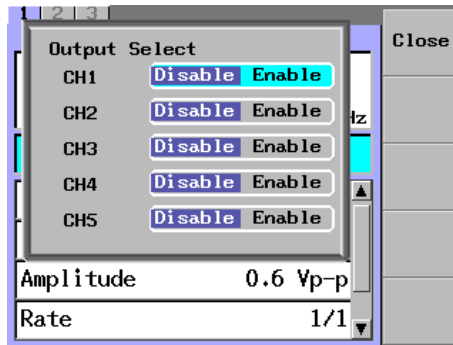

5. To set other channels, repeat step 4. After you have set all of the channels, press the **Close** soft key.  
When a channel is enabled, its corresponding number next to "Output CH" turns green.  
When a channel is disabled, its corresponding number next to "Output CH" turns gray.



Channel 1 is enabled.

### Explanation

When the clock signal (RF OUT) output is turned ON, you can select whether or not to transmit signals from each channel.

The ON/OFF setting affects all channels at the same time. So, set the output for each individual channel as necessary.

**Enable:** When output is turned on, a clock signal is transmitted from the RF OUT connector.

**Disable:** When output is turned on, a clock signal is not transmitted from the RF OUT connector.

## Setting the Clock Signal (RF OUT) Frequency (FREQ)

### Procedure

1. Press **DETAIL** to display the DETAIL screen.
2. Use the **SLOT** keys to select the SG module as the current module.
3. Press the **FREQ** soft key, or use the arrow keys to move the cursor to Frequency and press **ENTER**.  
A numeric input dialog box appears.

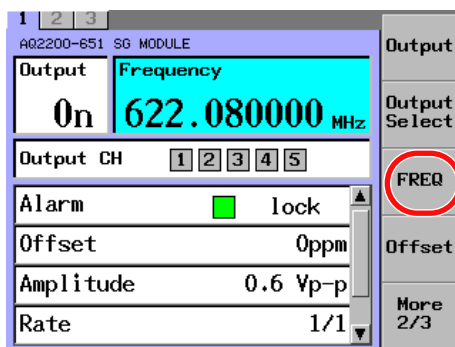

4. Use the numeric keypad or the arrow keys to change the value, and press **ENTER**.

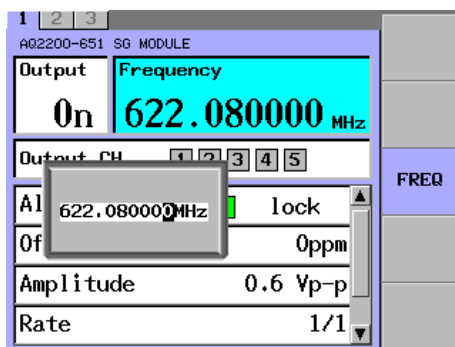

### Note

- When an offset is specified, the offset value is added to the frequency value.
- For an explanation of how to use the keypad, see section 2.3.

### Explanation

Set the clock signal (RF OUT) frequency in 0.000001 MHz steps.

The clock signal frequency range varies depending on the clock signal rate setting.

- When the rate is set to 1/1:  
The range is 620.000000 to 720.000000 MHz in 0.000001 MHz steps (the default value is 622.080000 MHz).
- When the rate is set to 1/4:  
The range is 155.000000 to 180.000000 MHz in 0.000001 MHz steps.

### Setting the Clock Signal (RF OUT) Frequency Offset (Offset)

#### Procedure

1. Press **DETAIL** to display the DETAIL screen.
2. Use the **SLOT** keys to select the SG module as the current module.
3. Press the Offset soft key, or use the arrow keys to move the cursor to Offset and press **ENTER**.  
A numeric input dialog box appears.

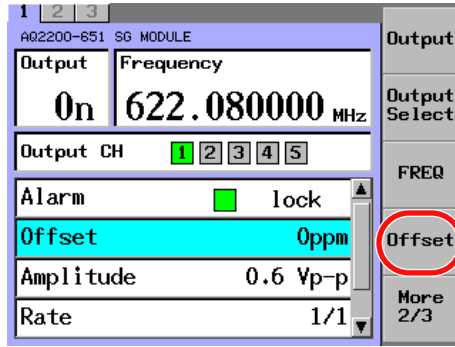

4. Use the numeric keypad or the arrow keys to change the value, and press **ENTER**.

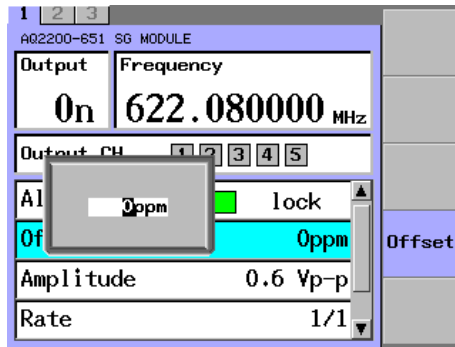

#### Note

For an explanation of how to use the keypad, see section 2.3.

#### Explanation

An offset is added to the clock signal (RF OUT) frequency value.  
 Range: -500 to +500 ppm in 1 ppm steps (default value: 0 ppm)  
 When an offset has been specified, "Offset" appears in the frequency display area.

Appears when an offset value has been set.

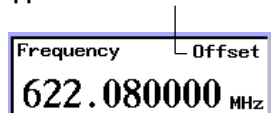

## Setting the Clock Signal (RF OUT) Amplitude (Amp)

### Procedure

1. Press **DETAIL** to display the DETAIL screen.
2. Use the **SLOT** keys to select the SG module as the current module.
3. Press the **Amp** soft key, or use the arrow keys to move the cursor to Amplitude and press **ENTER**.

A dialog box for selecting the amplitude appears.

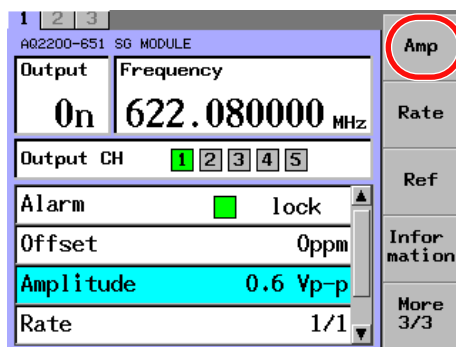

4. Use the arrow keys to move the cursor to 0.6 Vp-p or 1.1 Vp-p, and press the **OK** soft key or **ENTER**.

The dialog box disappears, and the selected item is confirmed and displayed.

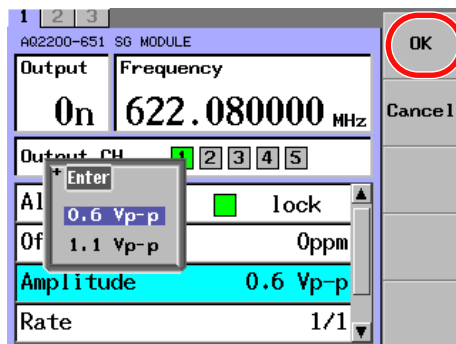

### Explanation

Set the clock signal (RF OUT) amplitude.

- 0.6Vp-p: The clock signal is transmitted at an amplitude of 0.8 Vp-p.
- 1.1 Vp-p: The clock signal is transmitted at an amplitude of 1.3 Vp-p. (The default value is 0.6 Vp-p.)



### Selecting the Clock Signal (RF OUT) Rate

#### Procedure

1. Press **DETAIL** to display the **DETAIL** screen.
2. Use the **SLOT** keys to select the SG module as the current module.
3. Press the **Rate** soft key, or use the arrow keys to move the cursor to Rate and press **ENTER**.

A dialog box for selecting the rate appears.

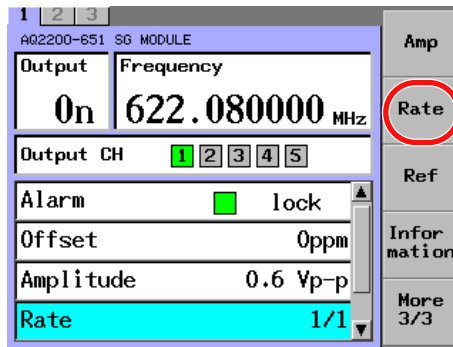

4. Use the arrow keys to move the cursor to 1/1 or 1/4, and press the **OK** soft key or **ENTER**.

The dialog box disappears, and the selected item is confirmed and displayed.

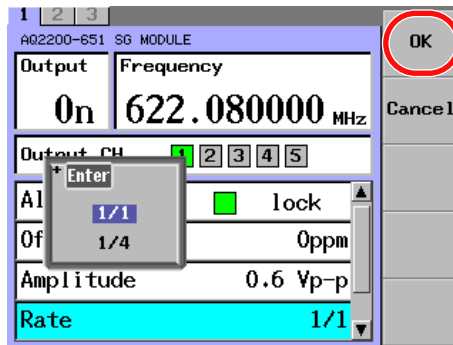

#### Explanation

Set the clock signal (RF OUT) rate.

- 1/1: The output rate is 620.000000 to 720.000000 MHz.
- 1/4: The output rate is 155.000000 to 180.000000 MHz. (The default value is 1/1.)

For details, see the explanation in Setting the Clock Signal (RF OUT) Frequency (FREQ) (page 10-5).

## Setting the Sync Reference Signal (Ref)

### Procedure

1. Press **DETAIL** to display the DETAIL screen.
2. Use the **SLOT** keys to select the SG module as the current module.
3. Press the **Ref** soft key, or use the arrow keys to move the cursor to Reference and press **ENTER**.

A dialog box for selecting the reference signal appears.

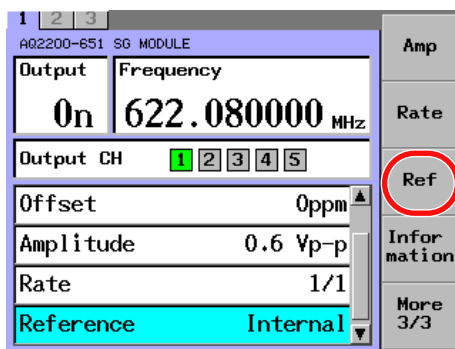

4. Use the arrow keys to move the cursor to Internal or External, and press the **OK** soft key or **ENTER**.

The dialog box disappears, and the selected item is confirmed and displayed.

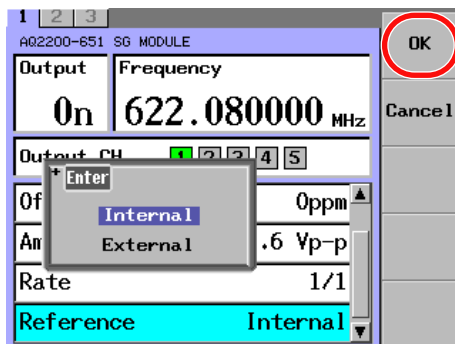

### Explanation

Select the reference signal to sync the clock signal (RF OUT) to.

- Internal: The transmitted clock signal is synchronized to the SG module's internal clock signal.
- External: The transmitted clock signal is synchronized to the signal that is received by the 10MHz REF IN connector.

### Returning to the Factory Default Settings (Module Preset)

#### Procedure

1. Press **DETAIL** to display the DETAIL screen.
2. Use the **SLOT** keys to select the SG module as the current module.
3. Press the Module **Preset** soft key.  
The Module Preset dialog box appears.

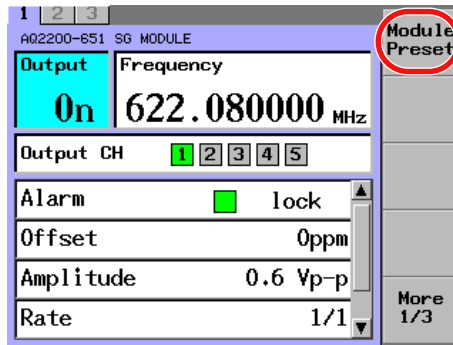

4. Press the **OK** soft key or **ENTER**.  
The dialog box disappears, and the SG module is returned to its factory default settings.

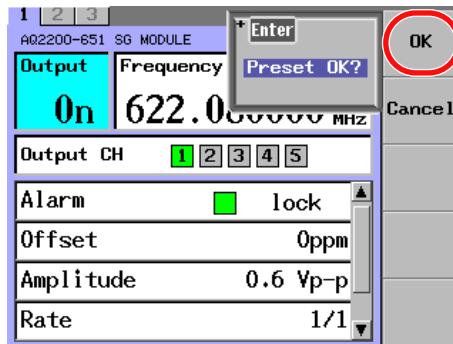

#### Explanation

Return the module to its factory default settings.  
For the factory default (initial) settings, see the “List of Default Settings” (page 13-29).

# 11.1 XFP Interface Module

## Display Screen

This section describes the display contents of the SUMMARY screen and DETAIL screen.

### SUMMARY Screen

#### 3-Slot Type

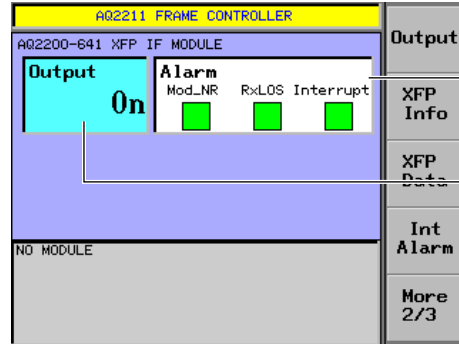

**Alarm**  
Shows the Alarm of XFP Transceiver

**Output**  
Shows the Output Status of XFP Transceiver

#### 9-Slot Type

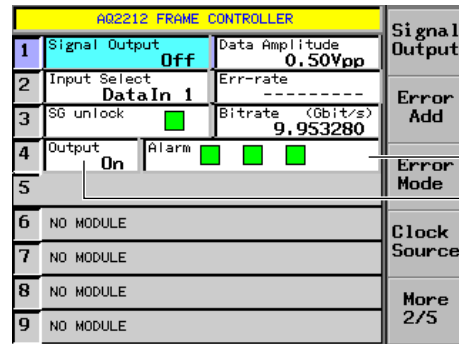

**Alarm**  
**Output**

### DETAIL Screen

#### Output

Shows the Output Status of XFP Transceiver

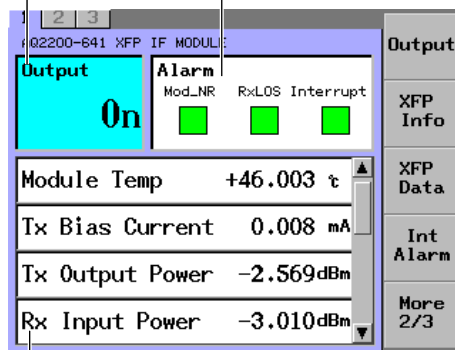

Displays the temperature inside the XFP Transceiver, the I/O optical level, and other information.

#### Alarm

Shows the Alarm of XFP Transceiver

#### Mod\_NR (Module Not Ready)

Indication	Status
Green	Mod_NR terminal signal level is L
Red	Mod_NR terminal signal level is H

#### RxLOS

Indication	Status
Green	Rx_LOS terminal signal level is L
Red	Rx_LOS terminal signal level is H

#### Interrupt

Indication	Status
Green	Interrupt terminal signal level is L
Red	Interrupt terminal signal level is H

**Soft Key Menu**

Name	Function
Output	Turning ON/OFF the XFP Transceiver Output
Unit	Selects the Power display unit
VCC5	Sets the Power Supply (5 V) of XFP Transceiver
VCC3	Sets the Power Supply (3.3 V) of XFP Transceiver
VCC2	Sets the Power Supply (1.8 V) of XFP Transceiver
VEE5	Sets the Power Supply (-5.2 V) of XFP Transceiver
Information	Shows the version information of XFP Interface Module
Module Preset	Returning Module to the Initial Values
XFP Info	Shows information of the XFP Transceiver
XFP Data	Shows the contents of the internal memory of the XFP Transceiver
XFP Alarm	Shows the alarm information that is written to the XFP transceiver's memory

**Analog Signal Monitor Function**

You can monitor analog signals to and from MSA (multi source agreement) compliant XFP Transceivers.

Name	Function
Module Temp	Internal temperature
Tx Bias Current	Transmission bias current
Tx Output Power	Transmission output power level
Rx Input Power	Receive input power level
APD Bias Volt*	APD bias voltage value
TEC Current*	Current of TEC
Laser Temp*	Laser temperature
Laser WL*	Laser wavelength
+5V Voltage*	VCC5 voltage value
+3.3V Voltage*	VCC3 voltage value
+1.8V Voltage*	VCC2 voltage value
-5.2V Voltage*	VEE5 voltage value
+5V Current*	VCC5 current value
+3.3V Current*	VCC3 current value
+1.8V Current*	VCC2 current value
-5.2V Current*	VEE5 current value

\* Due to the XFP Transceiver, the type of monitor supported is different. "AUX1" or "AUX2" is displayed if the monitor function is not supported, or if the XFP transceiver module is not installed.

**Power Supply Monitor Function**

You can monitor the XFP Interface Module's power supply.

Name	Function
VCC5	VCC5 Monitor Value
VCC3	VCC3 Monitor Value
VCC2	VCC2 Monitor Value
VEE5	VEE5 Monitor Value

**Note**

For I2C communication with the XFP transceiver, packet error check is enabled (write-protected).

## Turning ON/OFF the XFP Transceiver Output (Output)

### Procedure

To turn ON or OFF the XFP Transceiver Output, two setting methods are provided. Select a desired setting method corresponding to the application.

Follow the steps below to turn ON or OFF the Output.

Additionally, as the Output is turned ON, the LED on the light source panel will be lit.

### Setting through the Panel of the XFP Interface Module

Press the **OUTPUT** key on the Interface Module panel to switch the light source between ON and OFF.

### Setting through the Panel of the Frame Controller

1. Press **DETAIL** to display the DETAIL screen.
2. Use the **SLOT** keys to select an XFP Interface module as the current module.
3. Press the **Output** soft key, or move the cursor to Output with the arrow keys, and then press the **ENTER**.

The Output dialog box will appear.

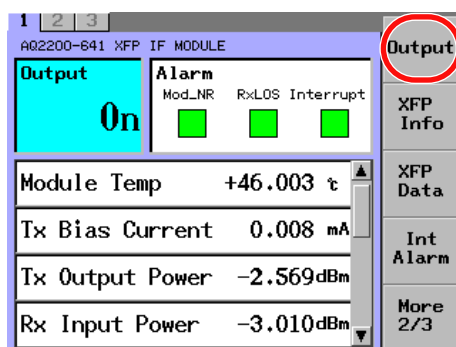

4. With the arrow keys, move the cursor to either On or Off, and press the **OK** soft key or **ENTER**.

The Output dialog box will disappear and the item you have selected is then set and displayed. For an explanation of how to select parameters, see section 2.3.

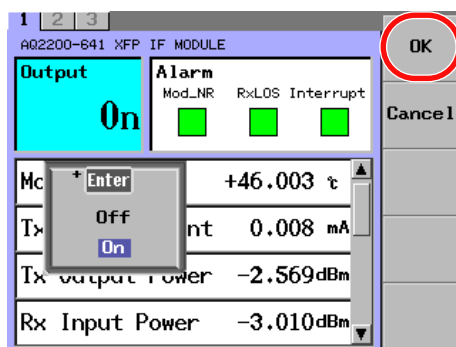

### Note

- When "Lock" is displayed in the "Opt" field, the optical output cannot be generated. One of the followings is the cause:
  - Interlock connector is open.
  - Laser output is locked.
 For details on how to generate the output, see section 2.9 "Unlocking the Laser Output" in [Startup Guide] (IM 735101-01EN).
- If an XFP Transceiver is not installed, "Off" is displayed to the Output Status.

### **Explanation**

Turns the XFP transceiver output on and off.

- On: Output is ON.
- Off: Output is OFF.

## Changing the Power Display Unit (Unit)

You can switch the power display unit between the dBm display and mW display.

### Procedure

1. Press **DETAIL** to display the DETAIL screen.
2. Use the **SLOT** keys to select an XFP Interface module as the current module.
3. Press the **Unit** soft key.  
The Unit dialog box will appear.

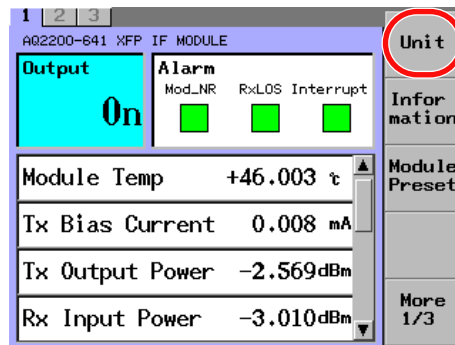

4. With the arrow keys, move the cursor to either On or Off, and press the **OK** soft key or **ENTER**.  
The Unit dialog box will disappear and the item you have selected is then set and displayed.

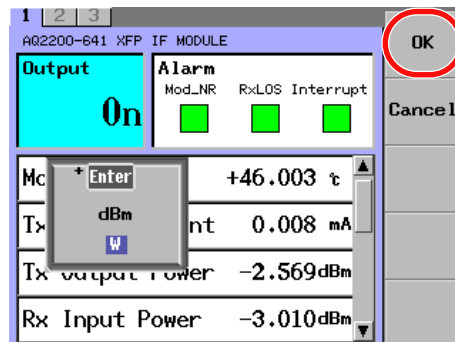

### Note

For an explanation of how to select parameters, see section 2.3.

### Explanation

Switches the units used to display Tx Output Power and Rx Input Power.

- dBm
- mW



### Changing the Power Supply of the XFP Transceiver (VCC5, VCC3, VCC2, VEE5)

You can supply power to the XFP transceiver compliant with the MSA stipulations. Note that these voltages value can be varied.

- VCC5 (+5 V)
- VCC3 (+3.3 V)
- VCC2 (+1.8 V)
- VEE5 (-5.2 V)

#### Procedure

#### Changing the VCC5 (+5 V)

1. Press **DETAIL** to display the DETAIL screen.
2. Use the **SLOT** keys to select an XFP Interface module as the current module.
3. Press the **VCC5** soft key, or move the cursor to Current Power Supply Value with the arrow keys, and then press the **ENTER**.

The VCC5 dialog box will appear.

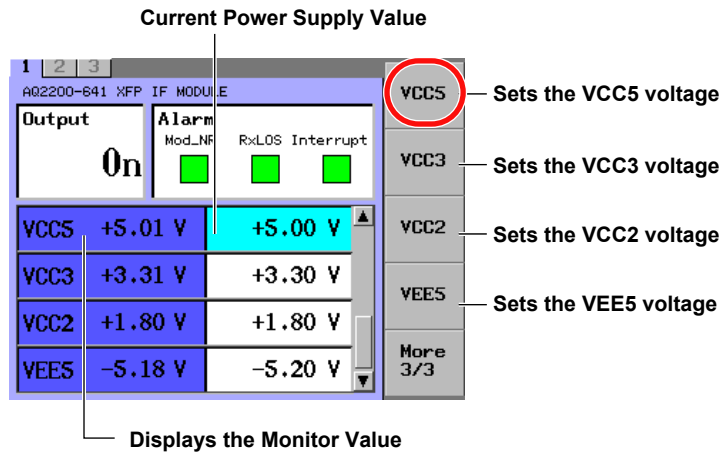

4. Change the numeric value with the ten-key pad or the arrow keys, and press the **OK** soft key or **ENTER**.

The VCC5 dialog box will disappear and the set value is then set and displayed.

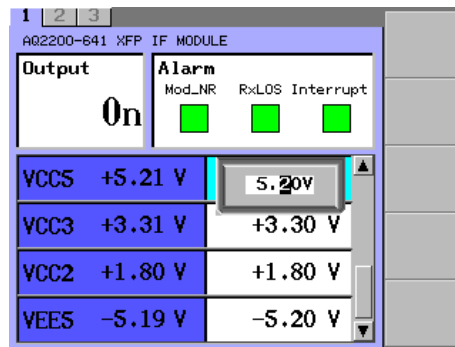

5. To change the value for other power supplies, switch to the power supply whose VCC5 value you want to change, and repeat steps 3 to 4.

**Note**

- This can be set even if an XFP Transceiver is not installed.
- For an explanation of how to change values, see section 2.3.

**Explanation**

You can supply the power specified by the XFP transceiver's MSA and vary the voltage. You can also display the supplied voltage value.

## Power Supply Range

- VCC5 (+5 V) 4.700 to 5.300 V in 0.001 V steps
- VCC3 (+3.3 V) 3.100 to 3.500 V in 0.001 V steps
- VCC2 (+1.8 V) 1.700 to 1.900 V in 0.001 V steps
- VEE5 (-5.2 V) -5.500 to -4.900 V in 0.001 V steps

### Displaying Information about the XFP Transceiver (XFP Info)

You can display the vendor name and parts number, etc., of MSA (multi source agreement) compliant XFP Transceivers.

#### Procedure

1. Press **DETAIL** to display the DETAIL screen.
2. Use the **SLOT** keys to select an XFP Interface module as the current module.
3. Press the **XFP Info** soft key.  
The XFP transceiver information screen appears.

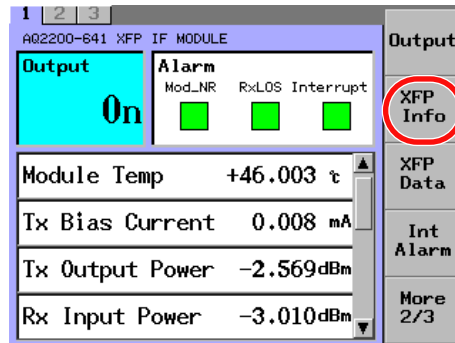

4. Press the **Close** soft key.  
The XFP transceiver information screen closes.

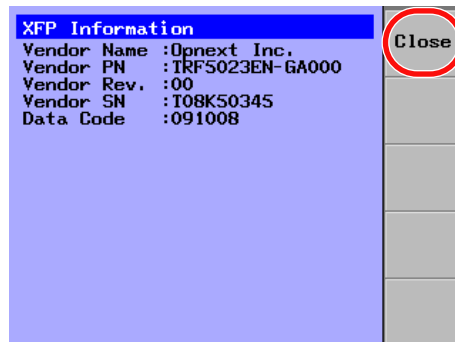

#### Note

If an XFP Transceiver is not installed, the XFP Info soft key is dimmed.

## Displaying XFP Transceiver–Internal Alarm Information (Int Alarm)

An alarm is detected inside the XFP Transceiver when Interrupt under Alarm is red. When this happens, you can display the alarm information that is written to the XFP Transceiver's memory.

### Procedure

1. Press **DETAIL** to display the DETAIL screen.
2. Use the **SLOT** keys to select an XFP Interface module as the current module.
3. Press the **Int Alarm** soft key.  
The XFP transceiver internal alarm information screen appears.

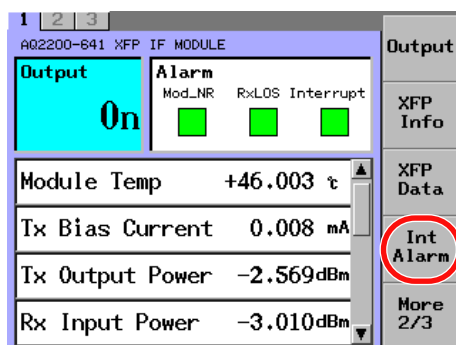

4. Press the **Close** soft key.  
The XFP transceiver internal alarm information screen closes.

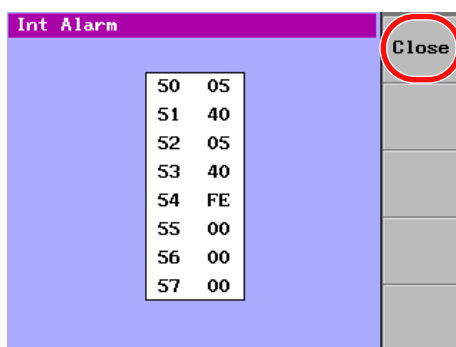

### Note

If an XFP Transceiver is not installed, the XFP Info soft key is dimmed.

### Displaying the Contents of the XFP Transceiver's Internal Memory (XFP Data)

You can display the contents of the internal memory of MSA (multi source agreement) compliant XFP Transceivers. The memory display consists of a lower table (Address 0-127h) and upper table (Address 128-255h). The Upper Table consists of multiple tables, and you can select the tables to display. Note that any upper-table page other than page 1 (XFP information) may be password-protected, meaning that you will need to enter the manufacturer-specified password in order to display it.

#### Procedure

#### Starting the Memory Data Display Screen

1. Press **DETAIL** to display the DETAIL screen.
2. Use the **SLOT** keys to select an XFP Interface module as the current module.
3. Press the **XFP Data** soft key.  
The memory data display screen opens.

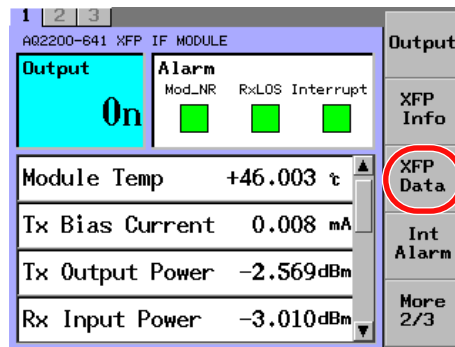

Page number of the Upper Table

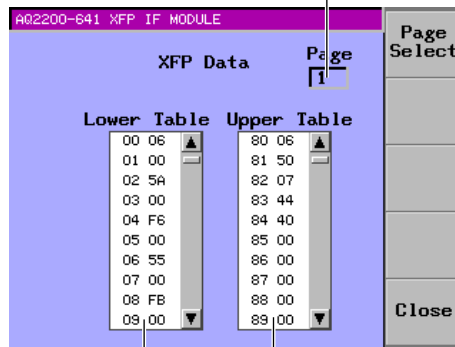

Data of the Upper Table (Address 80-FFh)

Data of the Lower Table (Address 00-7Fh)

The lower and upper tables are scrolled together. You can scroll the memory data display area using the arrow keys (▲▼).

### Switching the Upper Table Display

4. Press the **Page Select** soft key.  
The Page Select dialog box will appear.

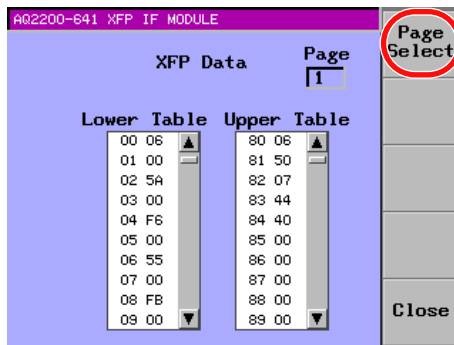

5. Use the arrow keys (▲▼) to select Password, and press **ENTER**.  
The soft keyboard appears.

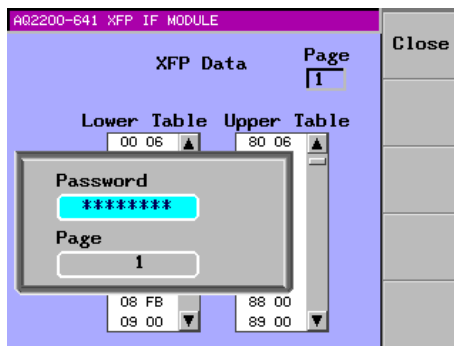

6. Enter a password, and press the **Commit** soft key.  
The soft keyboard closes.

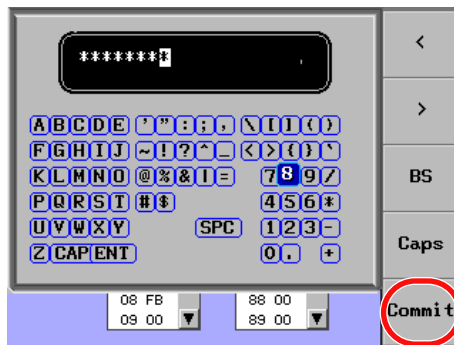

7. Use the arrow keys (▲▼) to select Page, and press **ENTER**.  
The Page dialog box appears.

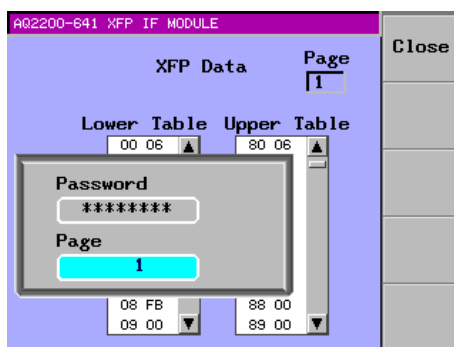

11.1 XFP Interface Module

- Use the numeric keypad or the arrow keys to switch to the page that you want to display, and press **ENTER**.  
The Page dialog box closes.

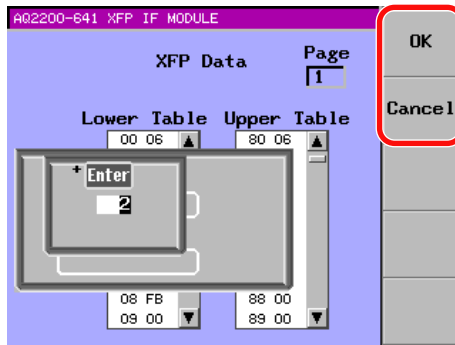

Only valid when a value is changed with the arrow keys

- Press the **Close** soft key.  
The Page Select dialog box closes, and the selected display appears.

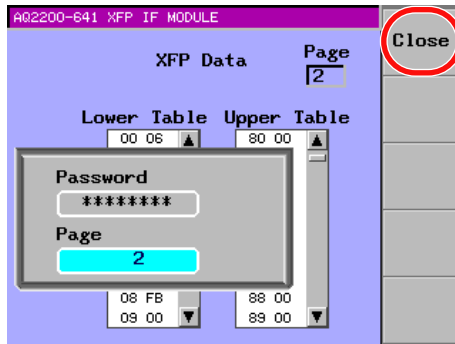

- Press the **Close** soft key to close the memory data display screen.

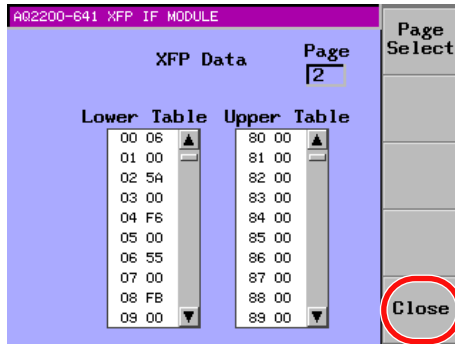

**Note**

- The following message appears if the password is incorrect, or if the specified page number cannot be selected. Check the setting again.

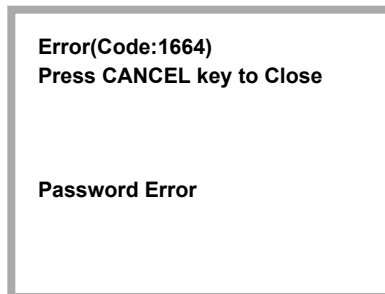

- For an explanation of how to change values, see section 2.3. For an explanation of how to enter text, see section 2.4.
- When a value is changed with the arrow keys, you can use the OK and Cancel soft keys.

## Returning to the Factory Default Settings (Module Preset)

### Procedure

1. Use the **SLOT** keys to select an XFP Interface module as the current module.
2. Press the **Module Preset** soft key.

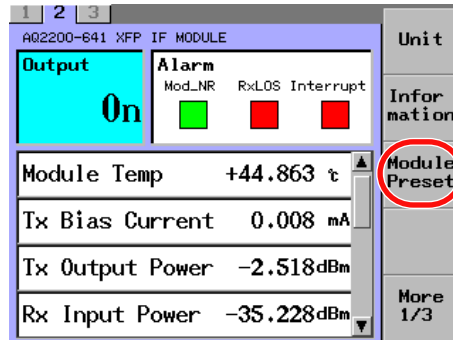

### Note

During initialization, "Executing" is displayed.

### Explanation

Return the module to its factory default settings.  
For the factory default (initial) settings, see the "List of Default Settings" (page 13-28).



# 11.2 Transceiver I/F Module

## Display Screen

This section describes the display contents of the SUMMARY screen and DETAIL screen.

### SUMMARY Screen

#### 3-Slot Type

A02211 FRAME CONTROLLER		Output
A02200-642 TRANCEIVER IF MODULE		
Output	Off	
NO MODULE		AIN THR
		PS CUR Limit
		More 2/4

#### Output

Shows the power supply and signal output states. Also, when the specified output current values for PS1 to PS5 are exceeded, or when the total power consumption of PS1 to PS5 goes above 28 W, "OL" (Over Load) appears. When "OL" appears, the output is turned off.

#### 9-Slot Type

A02212 FRAME CONTROLLER		Output
1	Output	
	Off	
2		
3	NO MODULE	
4	NO MODULE	AIN THR
5	NO MODULE	
6	NO MODULE	PS CUR Limit
7	NO MODULE	
8	NO MODULE	More 2/4
9	NO MODULE	

#### Output

DETAIL Screen

**Output**  
Shows the power supply and signal output states.

**AIN01 to AIN06**  
Optical transceiver status signal levels.  
When the voltage values fall outside of the monitor display range, the colors of the voltage indications change as described below.

- When the monitored voltage is at or above the upper limit (6.00 V): orange

**PS1 to PS5**  
Optical transceiver power supply voltage

**PS Power**  
Optical transceiver power consumption

**PS1 Current to PS5 Current**  
Optical transceiver current consumption

**R1**  
Shows the optical transceiver resistance for APS. If the resistance exceeds the measurement range, the letters are displayed using the following color.  
Orange: 10000 or greater

Scrolls through the display screen.

Status signal logic level (L/H)

Optical transceiver power supply settings

Soft Key Menu

Name	Function
Output	Turns the power supply and the control signal output ON or OFF
PS1	Sets the PS1 (5 V) output voltage
PS2	Sets the PS1 (3.3 V) output voltage
PS3	Sets the PS1 (0.8 V) output voltage
PS4	Sets the PS1 (-5.2 V) output voltage
PS5	Sets the PS1 (3.3 V/5 V) output voltage
I2C Set	Sets the I2C bus
MDIO Set	Sets MDIO communication
Ctrl Set	Sets the control signal output
AIN Edit	Edits the status signal monitor signal names
AIN THR	Sets the status signal monitor threshold.
PS CUR Limit	Sets the current consumption limit.
Module Preset	Initializes the transceiver I/F module
Information	Shows the version information of XFP Interface Module

Turning the Power Supply and Control Signal Output ON or OFF (Output)

**Procedure**

There are two ways to turn the power supply and the control signal output ON and OFF. Pick the method that is most appropriate for your situation.

To turn the power supply and the control signal output ON or OFF, follow the procedure below.

When the power supply and signal control are ON, the OUTPUT LED on the front panel of the transceiver I/F module is lit.

**Making Settings from the Transceiver I/F Module**

Press the **OUTPUT** key on the panel to switch the module ON and OFF.

**Making Settings from the Frame Controller Panel**

1. Press **DETAIL** to display the DETAIL screen.
2. Use the **SLOT** keys to select the transceiver I/F module as the current module.
3. Press the **Output** soft key, or use the arrow keys to move the cursor to Output and press **ENTER**.

A dialog box for turning the signal output on and off appears.

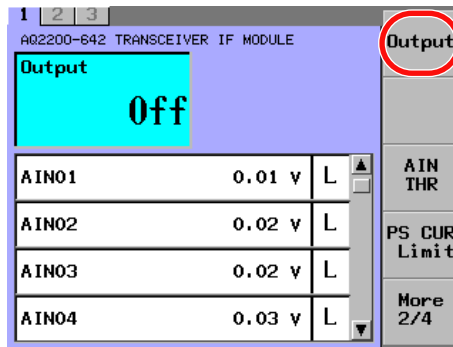

4. Use the arrow keys to move the cursor to On or Off, and press the **OK** soft key or **ENTER**.

The dialog box disappears, and the selected item is confirmed and displayed.

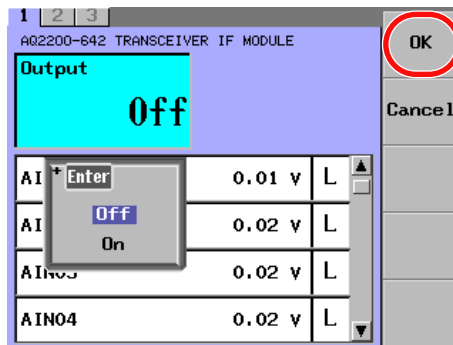

**Note**

For an explanation of how to select parameters, see section 2.3.

**Explanation**

Turn the transceiver signal (Output) output ON or OFF.

- On: Signal transmission occurs.
- Off: Signal transmission is stopped.

### Setting the Power Supply Voltage (PS1 to PS5)

Set the power supply voltage.

- PS1 (5 V)
- PS2 (3.3 V)
- PS3 (0.8 V)
- PS4 (-5.2 V)
- PS5 (3.3 V/5 V)

## Procedure

### Changing PS1 (5 V)

1. Press **DETAIL** to display the DETAIL screen.
2. Use the **SLOT** keys to select the transceiver I/F module as the current module.
3. Press the **PS1** soft key, or use the arrow keys to move the cursor to PS1 and press **ENTER**.

A numeric input dialog box appears.

Appears when the output is on and the power supply voltage monitor detects irregular values.

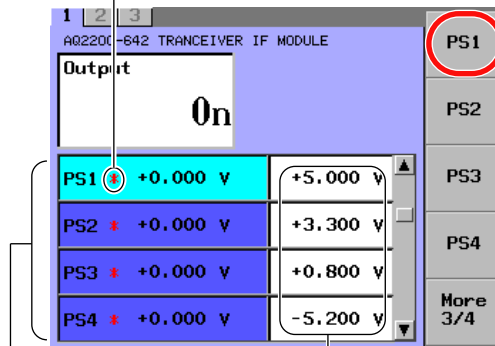

The specified power supply output voltage values

Monitors the power supply voltage

4. Use the numeric keypad or the arrow keys to change the value, and press **ENTER**.

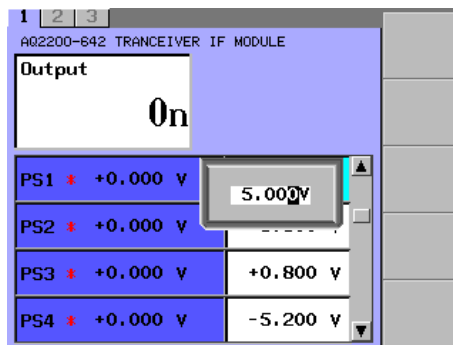

5. To change the value for other power supplies, switch to the power supply whose PS1 value you want to change, and repeat steps 3 and 4.

### **Note**

For an explanation of how to use the keypad, see section 2.3.

---

### **Explanation**

Set the voltage of the power that is supplied to the transceiver within the following ranges.

#### **Ranges**

- PS1: 4.750 to 5.250 V in 0.001 V steps (default value: 5.000 V)
- PS2: 3.135 to 3.465 V in 0.001 V steps (default value: 3.300 V)
- PS3: 0.800 to 1.890 V in 0.001 V steps (default value: 0.800 V)
- PS4: -5.460 to -4.940 V in 0.001 V steps (default value: -5.2 V)
- PS5: Cannot be changed: fixed at 3.3 or 5.0 V (default value: 3.3 V)

#### **Power Supply Voltage Monitor**

When the voltage values for PS1 to PS5 fall outside of the monitor display range, the colors of the voltage indications change as described below.

- When the monitored voltage is at or above the upper limit (6.00 V): orange
- When the monitored voltage is at or below the lower limit (-6.00 V): brown

## Configuring the I2C Bus (I2C Set)

### Procedure

1. Press **DETAIL** to display the DETAIL screen.
2. Use the **SLOT** keys to select the transceiver I/F module as the current module.
3. Press the **I2C Set** soft key.  
A dialog box for selecting the clock frequency and communication mode appears.

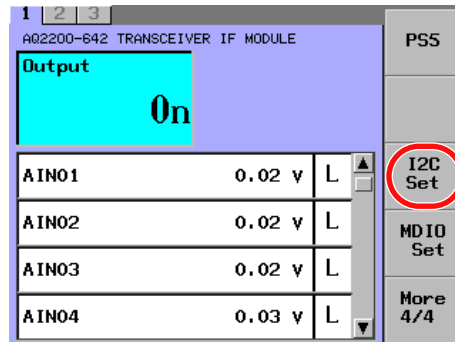

### Setting the Clock Frequency

4. Use the arrow keys to move the cursor to Clock Frequency, and press **ENTER**.  
A dialog box for selecting the clock frequency appears.

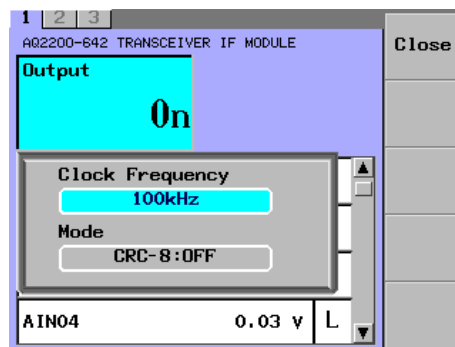

5. Use the arrow keys to move the cursor to 100 kHz or 400 kHz, and press the **OK** soft key or **ENTER**.  
The dialog box disappears, and the selected item is confirmed and displayed.

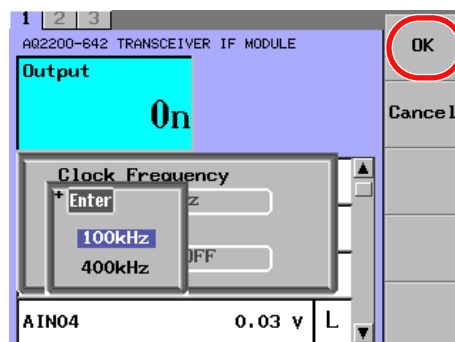

### Setting the Communication Mode

4. Use the arrow keys to move the cursor to Mode, and press **ENTER**.  
A dialog box for selecting the communication mode appears.

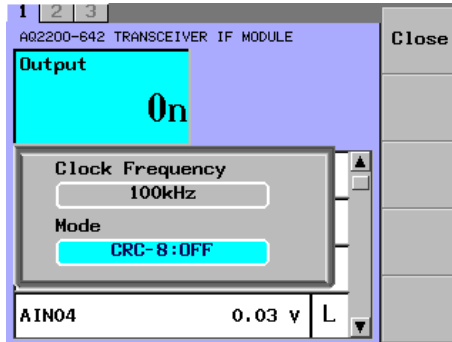

5. Use the arrow keys to move the cursor to CRC-8 OFF or CRC-8 ON, and press the **OK** soft key or **ENTER**.  
The dialog box disappears, and the selected item is confirmed and displayed.

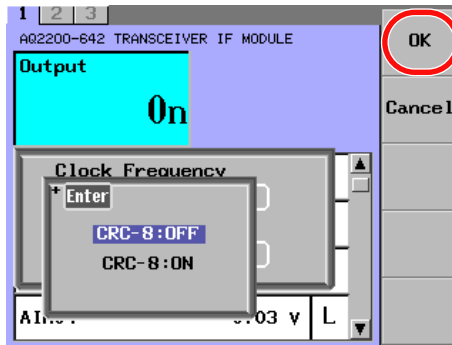

### Explanation

To access the internal ROM of an XFP or SFP+ optical module, set the I2C bus (Inter Integrated Circuit Bus) signal interface conditions.

#### Clock Frequency

Set the serial clock signal (SCL) frequency to 100 or 400 kHz.

#### Communication Mode

Turn packet error checking in I2C communication ON or OFF.

- CRC-8 OFF: Turns packet error checking OFF.
- CRC-8 ON: Turns packet error checking ON.

## Configuring MDIO Serial Communication (MDIO Set)

### Procedure

1. Press **DETAIL** to display the DETAIL screen.
2. Use the **SLOT** keys to select the transceiver I/F module as the current module.
3. Press the **MDIO Set** soft key.  
A dialog box for selecting the clock frequency appears.

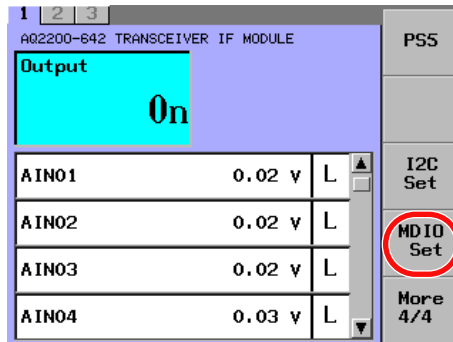

4. Use the arrow keys to move the cursor to 625 kHz, 1.25 MHz, or 2.5 MHz, and press the **OK** soft key or **ENTER**.  
The dialog box disappears, and the selected item is confirmed and displayed.

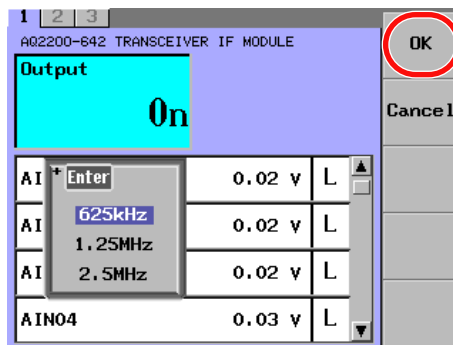

### Explanation

To access the internal ROM of a XENPAK optical module, set the MDIO serial communication (Management Data Input/Output) clock frequency. You can set the frequency to 2.5 MHz, 1.25 MHz, or 625 kHz. (The default value is 625 kHz.)



## Configuring the Control Signals (Ctrl Set)

### Procedure

1. Press **DETAIL** to display the DETAIL screen.
2. Use the **SLOT** keys to select the transceiver I/F module as the current module.
3. Press the **Ctrl Set** soft key.  
The Control Signal Set screen appears.

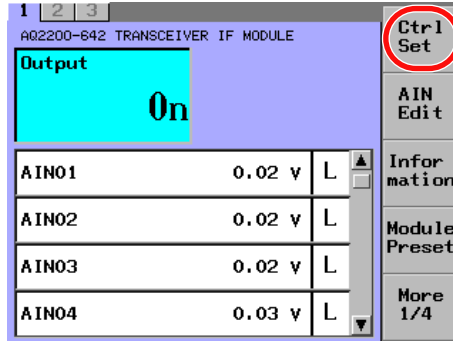

### Editing the Control Signal Names (Entering text)

4. Use the arrow keys to move the cursor to the signal name that you want to set (CTRL01 to CTRL17), and press **ENTER**.  
The soft keyboard appears.
5. Enter a signal name, and press the **Commit** soft key.  
The soft keyboard closes.

Signal name that will be edited

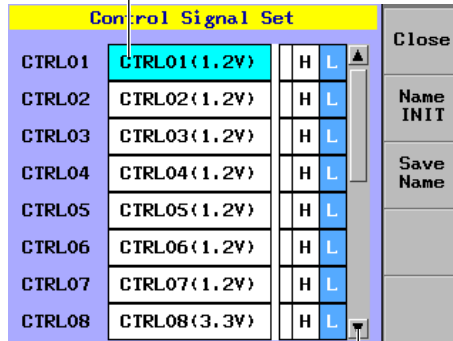

Scroll down to show signal names CTRL09 to CTRL17.

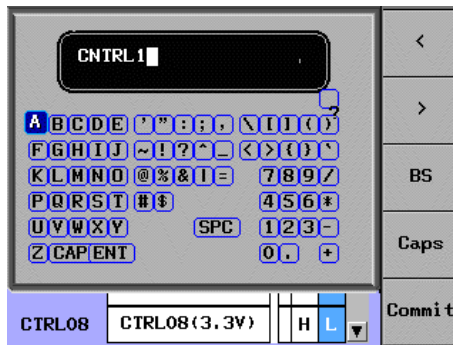

### Note

For an explanation of how to enter text, see section 2.4.

### Editing the Control Signal Names (Selecting default signal names)

4. Press the **Name INIT** soft key to display a dialog box for selecting the transceiver type.

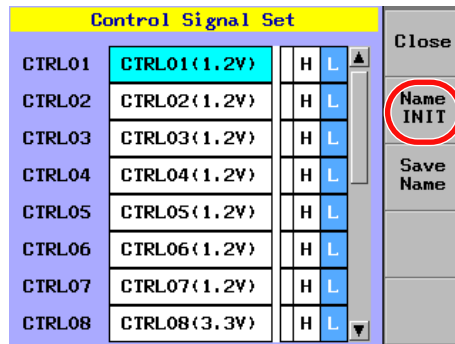

5. Use the arrow keys to move the cursor to SFP+, XFP, XENPAK, or Default, and press the **OK** soft key or **ENTER**.

The dialog box disappears, and the selected item is confirmed and displayed.

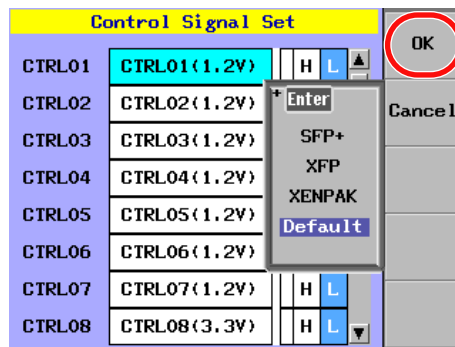

### Setting the Control Signal Logic

6. Use the arrow keys to move the cursor to the logic side (the column to the left of H and L), and press **ENTER**.

The setting switches between H and L each time you press ENTER.

Move the cursor here.

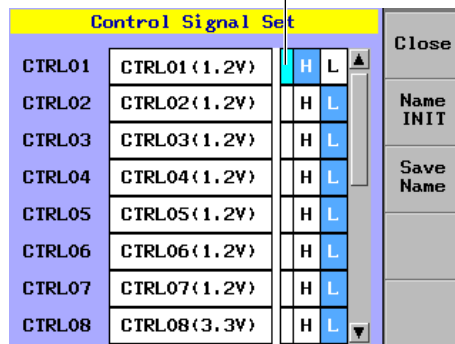

**Saving the Control Signal Names**

7. Press the **Save Name** soft key to save the edited control signal names.

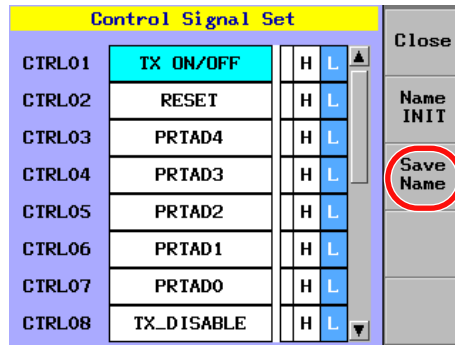

**Note**

- If you do not save the signal names, they change back to their previous settings after you turn off the power.
- The control signal names are saved in the transceiver I/F module.

8. Press the **Close** soft key to close the Control Signal Set screen.

**Set the logic and names of the control signals.**

Setting the Logic of the Control Signals

- L: The control signal logic is fixed at low.
- H: The control signal logic is fixed at high.  
 The high level voltage value for CTRL01 to CTRL07 is 1.2 V.  
 The high level voltage value for CTRL08 to CTRL17 is 3.3 V.

**Editing the Control Signal Names (Entering text)**

You can enter any name that you want to. The maximum number of characters is 12.

You can use the following characters.

Capital letters of the alphabet (A to Z), numbers (0 to 9), and the following symbols: underscores, slashes, parentheses, periods, and spaces.

**Editing the Control Signal Names (Selecting default signal names)**

There are preset names for each control signal that are based on the transceiver type, and you can name a signal just by selecting the appropriate transceiver.

The control signal names based on the transceiver types are listed below.

Control Signal	Default Name	XENPAK	XFP	SFP+
Ctrl01	CTRL01(1.2V)	TXON/OFF	CTRL01(1.2V)	CTRL01(1.2V)
Ctrl02	CTRL02(1.2V)	RESET	CTRL02(1.2V)	CTRL02(1.2V)
Ctrl03	CTRL03(1.2V)	PRTAD4	CTRL03(1.2V)	CTRL03(1.2V)
Ctrl04	CTRL04(1.2V)	PRTAD3	CTRL04(1.2V)	CTRL04(1.2V)
Ctrl05	CTRL05(1.2V)	PRTAD2	CTRL05(1.2V)	CTRL05(1.2V)
Ctrl06	CTRL06(1.2V)	PRTAD1	CTRL06(1.2V)	CTRL06(1.2V)
Ctrl07	CTRL07(1.2V)	PRTAD0	CTRL07(1.2V)	CTRL07(1.2V)
Ctrl08	CTRL08(3.3V)	CTRL08(3.3V)	TX_DIS	TX_DISABLE
Ctrl09	CTRL09(3.3V)	CTRL09(3.3V)	P_DOWN/RST	CTRL09(3.3V)
Ctrl10	CTRL10(3.3V)	CTRL10(3.3V)	MOD_DESEL	RS0
Ctrl11	CTRL11(3.3V)	CTRL11(3.3V)	CTRL11(3.3V)	RS1
Ctrl12	CTRL12(3.3V)	CTRL12(3.3V)	CTRL12(3.3V)	CTRL12(3.3V)
Ctrl13	CTRL13(3.3V)	CTRL13(3.3V)	CTRL13(3.3V)	CTRL13(3.3V)
Ctrl14	CTRL14(3.3V)	CTRL14(3.3V)	CTRL14(3.3V)	CTRL14(3.3V)
Ctrl15	CTRL15(3.3V)	CTRL15(3.3V)	CTRL15(3.3V)	CTRL15(3.3V)
Ctrl16	CTRL16(3.3V)	CTRL16(3.3V)	CTRL16(3.3V)	CTRL16(3.3V)
Ctrl17	CTRL17(3.3V)	CTRL17(3.3V)	CTRL17(3.3V)	CTRL17(3.3V)

### Configuring the Status Signal Monitor (AIN Edit)

#### Procedure

1. Press **DETAIL** to display the DETAIL screen.
2. Use the **SLOT** keys to select the transceiver I/F module as the current module.
3. Press the **AIN Edit** soft key to display the AIN Signal Name Edit screen.

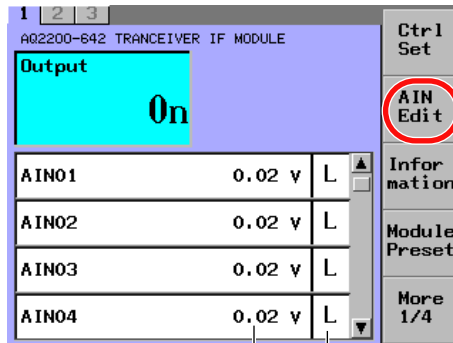

Status signal monitor logic levels  
Status signal monitor voltage values

#### Editing the Status Signal Monitor Names (Entering text)

4. Use the arrow keys to move the cursor to the signal name that you want to set (AIN01 to AIN06), and press **ENTER**.  
The soft keyboard appears.
5. Enter a signal name, and press the **Commit** soft key.  
The soft keyboard closes.

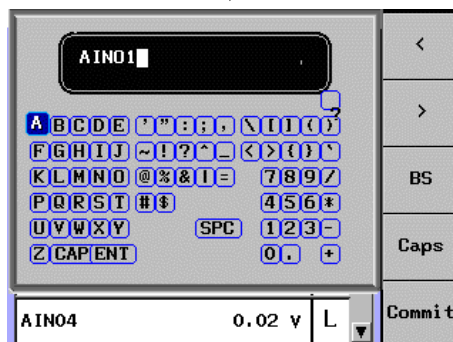
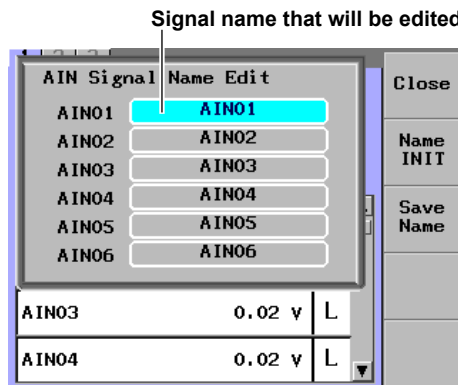

#### Note

For an explanation of how to enter text, see section 2.4.

**Editing the Status Signal Monitor Names (Selecting default signal names)**

4. Press the **Name INIT** soft key to display a dialog box for selecting the transceiver type.



5. Use the arrow keys to move the cursor to SFP+, XFP, XENPAK, or Default, and press the **OK** soft key or **ENTER**.  
The dialog box disappears, and the selected item is confirmed and displayed.

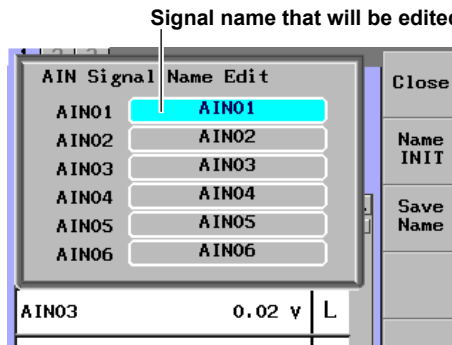

**Saving the Signal Names**

6. Press the **Save Name** soft key to save the edited monitor signal names.



**Note**

- If you do not save the signal names, they change back to their previous settings after you turn off the power.
- The monitor signal names are saved in the transceiver I/F module.

7. Press the **Close** soft key to close the AIN Signal Name Edit screen.

**Explanation**

Edit the names of the monitor input signals from the transceiver.

**Editing the Status Signal Monitor Names (Entering text)**

You can enter any name that you want to. The maximum number of characters is 12.

You can use the following characters.

Capital letters of the alphabet (A to Z), numbers (0 to 9), and the following symbols: underscores, slashes, parentheses, periods, and spaces.

**Editing the Status Signal Monitor Names (Selecting default signal names)**

There are preset names for each monitor signal that are based on the transceiver type, and you can name a signal just by selecting the appropriate transceiver.

The monitor signal names based on the transceiver types are listed below.

Monitor Signal	Default Name	XENPAK	XFP	SFP+
AIN01	AIN01	LASI	MOD_NR	TX_FAULT
AIN02	AIN02	AIN02	RX_LOS	RX_LOS
AIN03	AIN03	AIN03	B_INTERRUPT	AIN03
AIN04	AIN04	MOD_DET	AIN04	AIN04
AIN05	AIN05	AIN05	MOD_ABS	AIN05
AIN06	AIN06	AIN06	AIN06	MOD_ABS

## Setting the Transceiver Monitor Signal Thresholds (AIN THR)

### Procedure

1. Press **DETAIL** to display the DETAIL screen.
2. Use the **SLOT** keys to select the transceiver I/F module as the current module.
3. Press the **AIN THR** soft key to display the AIN Threshold Voltage screen.

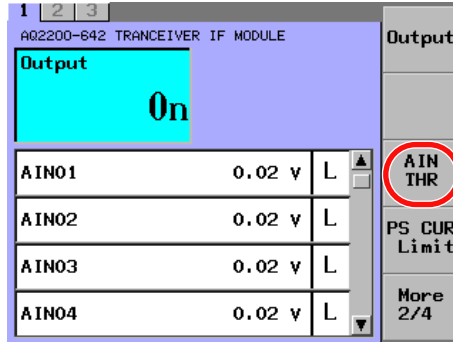

4. Use the arrow keys to move the cursor to the name of the monitor signal whose threshold you want to set (AIN01 to AIN06), and press **ENTER**.  
A numeric input dialog box appears.

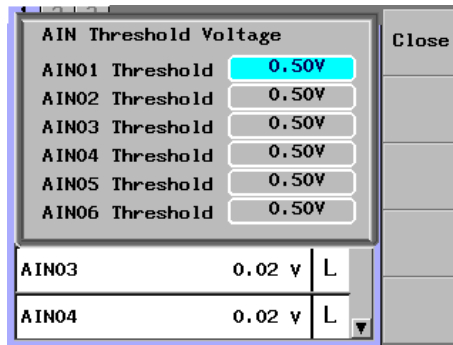

5. Use the numeric keypad or the arrow keys to change the value, and press **ENTER**.

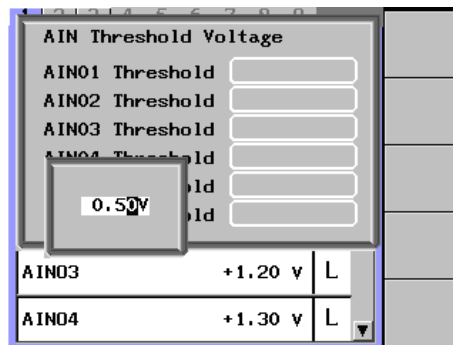

### Note

For an explanation of how to use the keypad, see section 2.3.

6. Press the **Close** soft key to close the AIN Threshold Voltage screen.

**Explanation**

Set the logic level thresholds (Threshold Voltage) for the monitor input signals from the transceiver.

Range: 0.10 to 3.00 V in 0.01 V steps (default value: 0.50 V)

The monitor signal logic level L/H states change according to the following conditions.

- Logic level > threshold: H
- Logic level  $\leq$  threshold: L

When the voltage values fall outside of the monitor display range, the colors of the voltage indications change as described below.

- When the monitored voltage is at or above the upper limit (6.00 V): orange



Setting the Current Consumption Limit (PS CUR Limit)

**Procedure**

1. Press **DETAIL** to display the DETAIL screen.
2. Use the **SLOT** keys to select the transceiver I/F module as the current module.
3. Press the **PS CUR Limit** soft key to display the PS Current Limit screen.

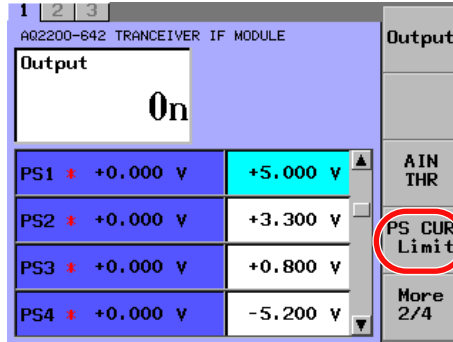

4. Use the arrow keys to move the cursor to the transceiver power supply (PS1 to PS5) whose current consumption limit you want to set, and press **ENTER**. A numeric input dialog box appears.

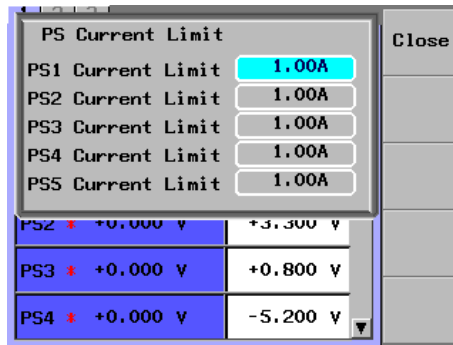

5. Use the numeric keypad or the arrow keys to change the value, and press **ENTER**.

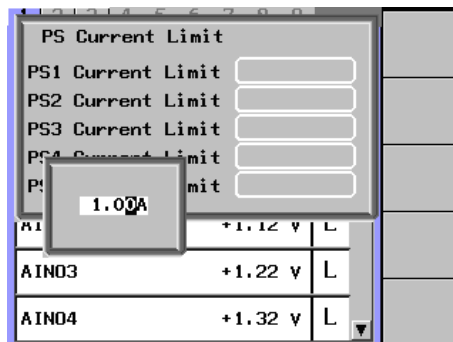

**Note**

For an explanation of how to use the keypad, see section 2.3.

6. Press the **Close** soft key to close the PS Current Limit screen.

**Explanation**

When you are providing power (PS1 to PS5) to the transceiver, use the current consumption limit to automatically turn off the power supply (PS1 to PS5) and control signal output (CTRL01 to CTRL17) when the transceiver's current consumption exceeds the amount of current that it receives from the transceiver I/F module.

**Ranges**

- PS1: 0.10 to 1.80 A in 0.01 A steps (default value: 1.00 A)
- PS2: 0.10 to 3.00 A in 0.01 A steps (default value: 1.00 A)
- PS3: 0.10 to 1.80 A in 0.01 A steps (default value: 1.00 A)
- PS4: 0.10 to 3.00 A in 0.01 A steps (default value: 1.00 A)
- PS5 (when 3.3 V is selected): 0.10 to 2.00 A in 0.01 A steps (default value: 1.00 A)  
(when 5.0 V is selected): 0.10 to 1.00 A in 0.01 A steps (default value: 1.00 A)

**Error Message**

When the specified current consumption limit is exceeded, in the SUMMARY and DETAIL screens, the Output indication changes from On to OL (OL: Over Load).

Returning to the Factory Default Settings (Module Preset)

**Procedure**

1. Press **DETAIL** to display the DETAIL screen.
2. Use the **SLOT** keys to select the transceiver I/F module as the current module.
3. Press the **Module Preset** soft key.  
The Module Preset dialog box appears.

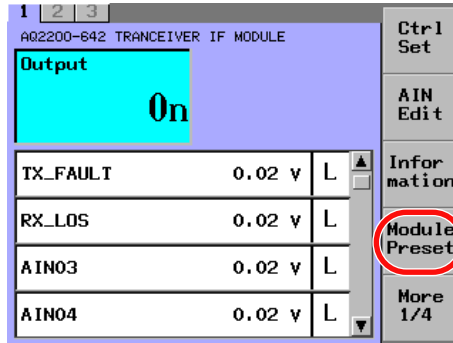

4. Press the **OK** soft key or **ENTER**.  
The dialog box disappears, and the transceiver I/F module is returned to its factory default settings.

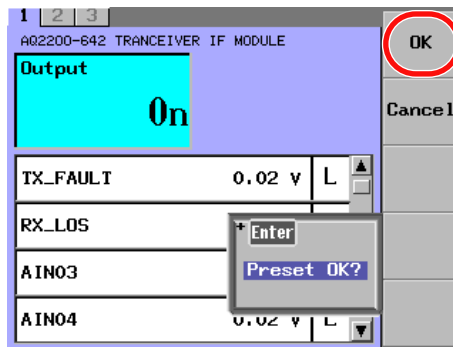

**Explanation**

Return the module to its factory default settings.  
For the factory default (initial) settings, see the "List of Default Settings" (page 13-28).  
The control signal and monitor signal names are not initialized.

# 12.1 Keys and Displays Used for Operation

## File Operation Window (File List)

### Procedure

#### Displaying the File Operation Window

1. To display the file operation window, press **FILE** or the **File** soft key for one of the various modules.

#### Performing Operations in the File Operation Window

2. To display a list of the files in a drive, use the arrow keys to move the cursor to the drive, and press **ENTER**.
3. To display a list of the files in a folder, use the arrow keys to move the cursor to the folder, and press **ENTER**.

#### Selecting the Types of Files to Show in the File List

4. Press the **Filter** soft key to display the file type selection dialog box.
5. Use the arrow keys to move the cursor to the file type that you want to use, and press **ENTER**.

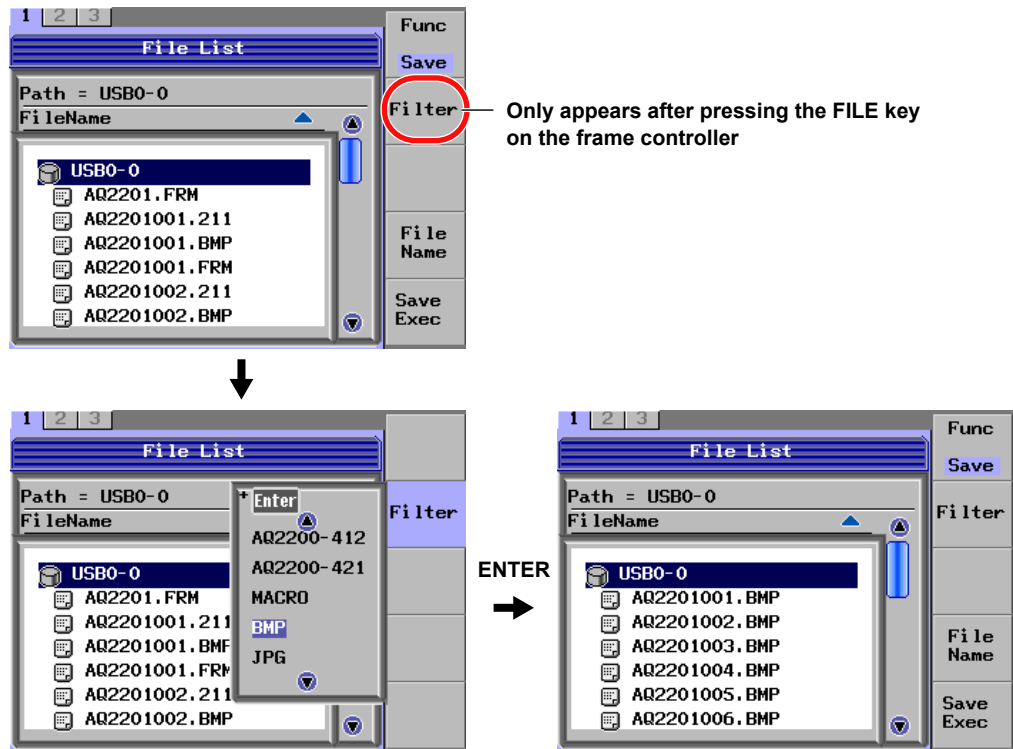

#### Note

The Filter soft key only appears after you press the FILE key on the frame controller.

## 12.1 Keys and Displays Used for Operation

### Selecting a File Operation

1. To display the file operation window, press **FILE** or the **File** soft key for one of the various modules.
2. Press the **Func** soft key to display the file operation selection dialog box.
3. Use the arrow keys to move the cursor to the operation that you want to use, and press the **OK** soft key or **ENTER**.

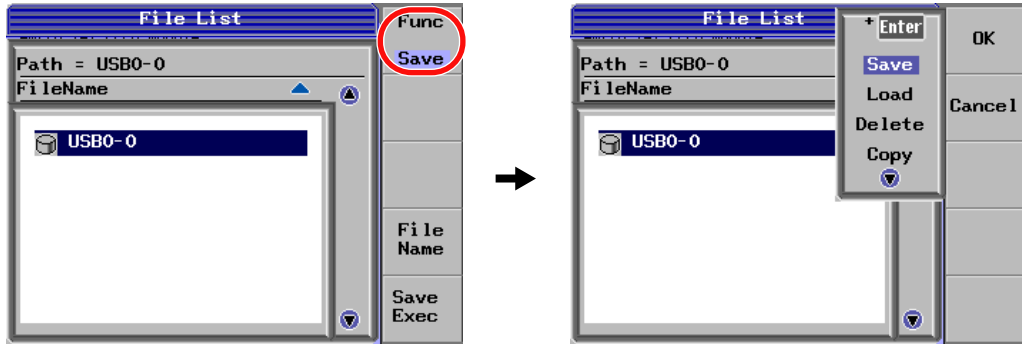

### Explanation

#### File Operations

- Save (to save setup data and measurement data)
- Load (to load setup data)
- Delete (to delete files and folders)
- Copy (to copy files)
- Rename (to rename files)
- Mk Dir (to create folders)

#### Filter Options

Each filter displays different types of files.

Filter Name	Displayed File Types
ALL	All files
FRAME	AQ2211/AQ2212 setup files
AQ2200-xxx	Module setup files
MACRO	Macro files
BMP	Files with .bmp extensions
JPG	Files with .jpg extensions
PNG	Files with .png extensions

#### Note

The filter feature is only valid when you press the FILE key on the frame controller.

## 12.2 Saving Setup Data, Measured Data, and Screen Captures

### Saving Setup Data

You can save the currently specified parameters to a storage device.

You must save the parameters by the frame controller or measurement module type.

Follow the steps below to save the necessary parameters of the frame controller or module.

### Procedure

#### Saving Frame Controller Parameters

1. Press **FILE** to display the file operation window.
2. Press the **Func** soft key to display the file operation selection dialog box.
3. Use the arrow keys to move the cursor to Save, and press the **OK** soft key or **ENTER**.

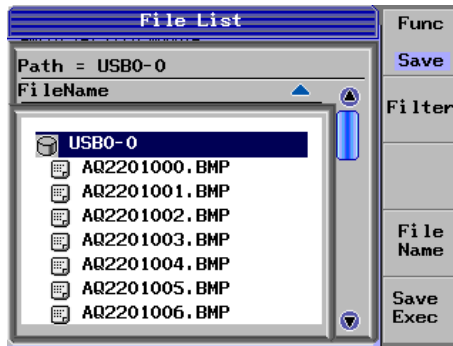

4. Use the arrow keys to move the cursor to the storage device that you want to save to.

#### Assigning a File Name

5. Press the **File Name** soft key.  
The File Name dialog box appears.
6. Use the arrow keys to move the cursor to Auto Numbering, and press **ENTER**.  
Auto Numbering switches between ON and OFF each time you press **ENTER**.  
Select ON to automatically add numbers to file names.

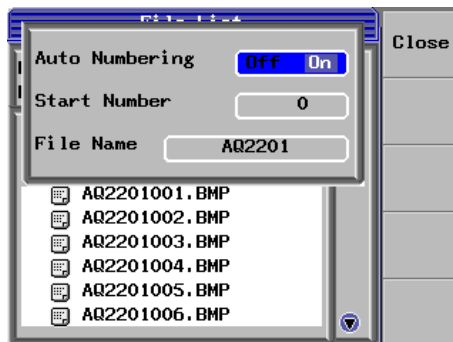

## 12.2 Saving Setup Data, Measured Data, and Screen Captures

- Use the arrow keys to move the cursor to Start Number, and press **ENTER**.  
The file number dialog box appears.
- Use the numeric keypad or the arrow keys to **ENTER** a file number, and press the **OK** soft key or **ENTER**.

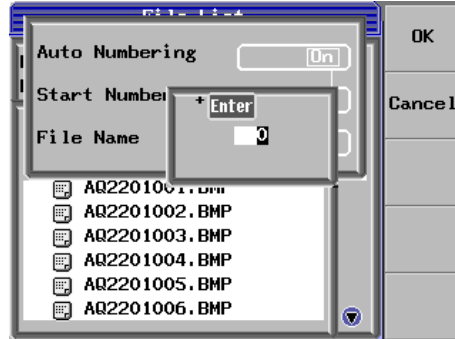

- Use the arrow keys to move the cursor to File Name, and press **ENTER**.  
A soft keyboard appears for you to use to **ENTER** the file name.
- After you **ENTER** the file name, press the **Commit** soft key.  
For details on entering characters, see section 2.4 "Inputting a Character String".

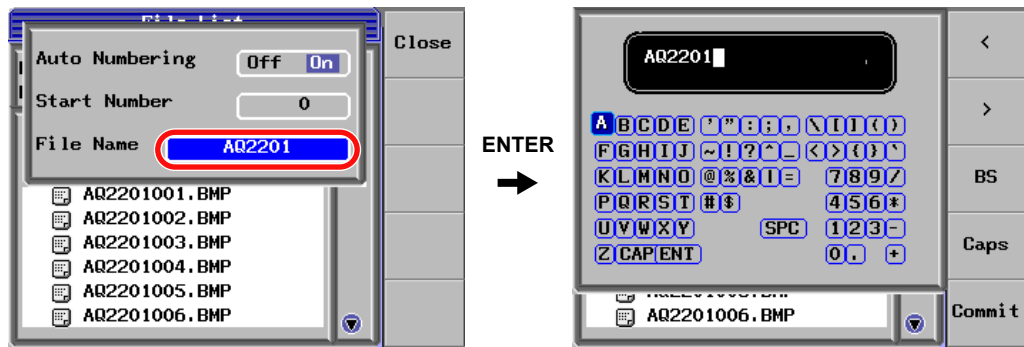

- Press the **Close** soft key.  
The File Name dialog box closes.
- Press the **Save Exec** soft key.  
The file is saved.

### Note

- Start Number is valid when Auto Numbering is set to ON.
- You can set Start Number to a value from 0 to 990.
- Three-digit numbers are added to the file names. (Example: 10 → 010)
- If Auto Numbering is enabled and a Start Number has been specified, whenever you press the Save Exec soft key, numbers will be added to the names of saved files in order starting with the specified Start Number.
- Extensions are automatically added to files based on their file type.
- You cannot overwrite a file. If you want to save a new file with the same name as an older one, you must first delete the older file.

### Saving Module Parameters

To save module parameters to a storage device:

1. Press **SLOT** to make the module whose parameters you want to save the current module.
2. Press the **Menu** soft key.
3. Press the **File** soft key to display the file operation window.
4. Press the **Func** soft key to display the file operation selection dialog box.
5. Use the arrow keys to move the cursor to Save, and press the **OK** soft key or **ENTER**.
6. Use the arrow keys to move the cursor to the storage device that you want to save to.

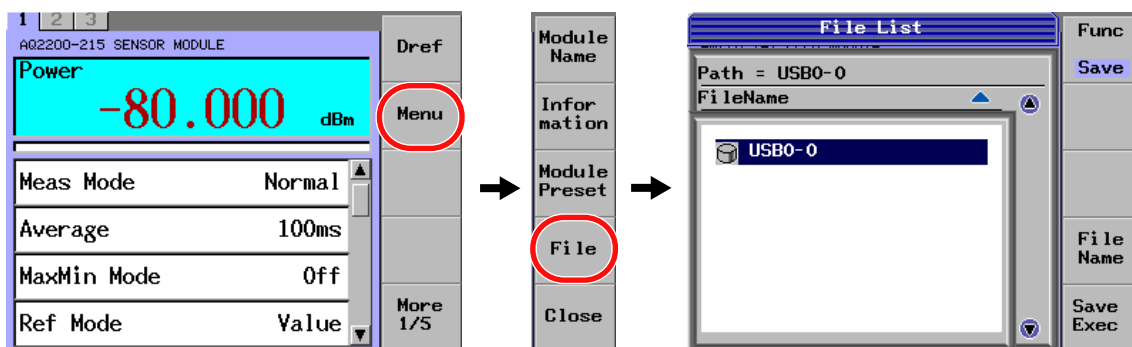

### Assigning a File Name

7. Perform steps 5 and onwards listed on page 12-3 for saving frame controller parameters.

### CAUTION

Never attempt to remove the storage device while the data is being written into the storage device. At this time, if the storage device is removed, this may cause the storage device to break.

### French

### ATTENTION

Ne jamais essayer de retirer un dispositif de stockage pendant l'écriture de données sur ce dernier. Cela risquerait de le casser.

### Note

“File” appears in the upper right while files are being saved.



## 12.2 Saving Setup Data, Measured Data, and Screen Captures

### Saving the Log Information (AQ2200-202)

Save the AQ2200-202 Max/Min measurement log to a storage device.

1. Select the AQ2200-202 for the current module with SLOT.
2. Press the **Log Save** soft key.
3. Move the cursor using the arrow keys to the save destination storage device.

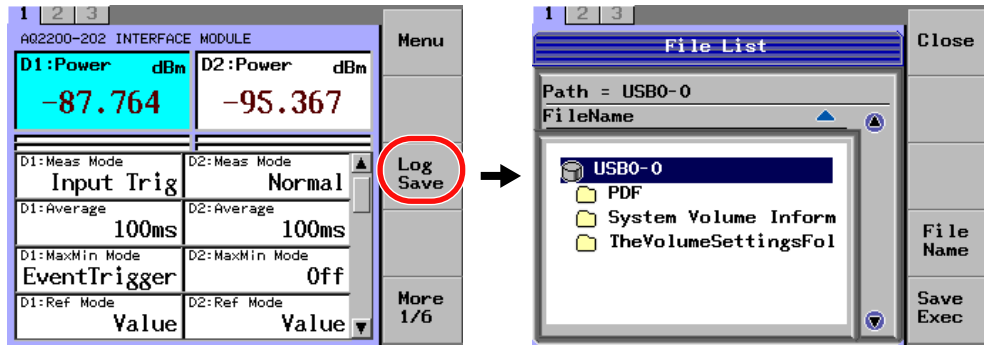

### Assigning a File Name

4. Continue from step 5 on page 12-3 for saving frame controller parameters.

### Explanation

#### Extensions

When you save a file, an extension is added to it automatically.

The added extension varies depending on the file type.

Extension	File Type
.FRM	Frame controller parameters
.XXX	AQ2200-XXX module parameters

### List of Modules Whose Parameters Can Be Saved and Their Extensions

Module Name	Extension
AQ2200-111	.111
AQ2200-112	.112
AQ2200-131	.131
AQ2200-132	.132
AQ2200-136	.136
AQ2200-141	.141
AQ2200-142	.142
AQ2200-211	.211
AQ2200-215	.215
AQ2200-221	.221
AQ2200-212	.212
AQ2200-222	.222
AQ2200-202	.202
AQ2200-231	.231
AQ2200-241	.241
AQ2200-271	.271
AQ2200-311	.311
AQ2200-311A	.311
AQ2200-312	.312
AQ2200-331	.331
AQ2200-332	.332
AQ2200-342	.342
AQ2200-411	.411
AQ2200-412	.412
AQ2200-421	.421

### Saving the Measurement Data

You can save the measurement data to a storage device.  
 You can use the logging, stability, and swept features in the application menu to save measurement data.  
 Save the measurement data after measurement.  
 For information on how to save the measured data, see the explanations of the measurement operations for the various modules.

### Saving Displayed Measurement Value (AQ2200-202, AQ2200-212 and AQ2200-222 only)

You can save the currently displayed measurement value to a storage device.  
 For information on how to save the value, see page 3-32.

### Saving the Log Information (AQ2200-202, AQ2200-212 and AQ2200-222 only)

The following data is saved.  
 The extension is .csv.

Row number	Item	Description
1	Date	Date when the file is saved
3	Slot/Channel number	Slot number and channel number of the measured parameter 0-Slot number-Channel number
4	Module name	Name of the power meter that made the measurement
5	Serial No.	Serial number of the power meter that made the measurement
7	MAX[dBm]	Maximum value of the measured Max/Min data
8	MIN[dBm]	Minimum value of the measured Max/Min data
9	DIF[dB]	Max-Min of the measured Max/Min data
12+	Power[dBm]	Measured power in dBm
	Status	0: Normal data 1: Range over 2: Range under 3: Range switching
	Event	If a measurement is made with MaxMin mode set to EventTrigger, "E" is written in the data row at the position where the event occurs.

2018/2/2	11:35:41	
Slot 0-3-1		
Module name	AQ2200-232 OPTICAL SENSOR HEAD	
Serial No.	1234567	
MAX[dBm]	8.5463	
MIN[dBm]	-87.3112	
DIF[dB]	95.8575	
Power[dBm]	Status	Event
8.55E+00	0	
8.54E+00	0	
8.54E+00	0	
8.08E+00	3	
-8.22E+01	2	E
-8.51E+01	2	
-8.59E+01	2	
-8.67E+01	2	
-8.70E+01	2	
-8.73E+01	2	

## Saving Screen Captures

You can save a screen capture to a storage device.

### Procedure

#### Selecting a File Format

1. Press **SYSTEM** to display the SYSTEM screen.
2. Use the arrow keys to move the cursor to Image Format, and press the **Select** soft key or **ENTER**.  
The file format selection dialog box appears.
3. Use the arrow keys to move the cursor to BMP, JPG, or PNG, and press the **OK** soft key or **ENTER**.

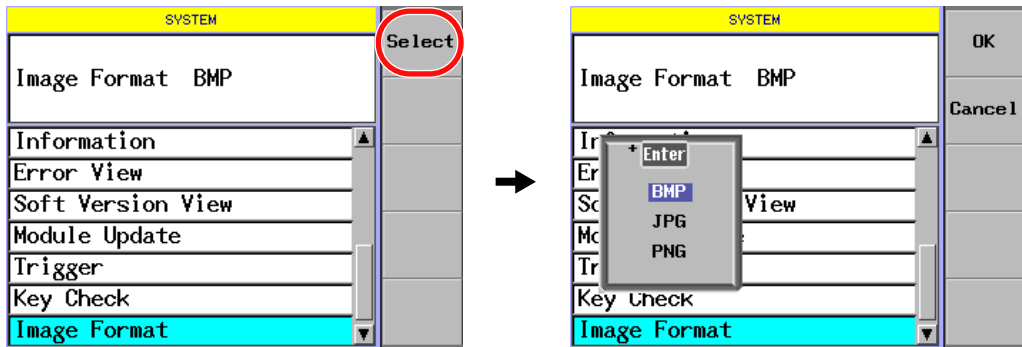

#### Specifying the Save Destination

4. Press **FILE** to display the file operation window.
5. Press the **Func** soft key to display the file operation selection dialog box.
6. Use the arrow keys to move the cursor to Save, and press the **OK** soft key or **ENTER**.
7. Use the arrow keys to move the cursor to the storage device that you want to save to.

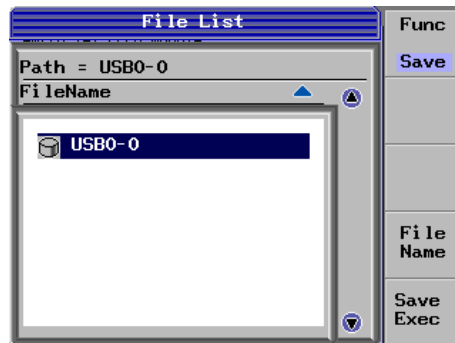

#### Assigning a File Name

8. Perform steps 5 and onwards listed on page 12-3 for saving frame controller parameters.

#### Saving

9. Show the display that you want to save.
10. Press **PRTSC** to take the screen capture.

## 12.3 Loading Setup Data and Macros

You can recreate parameter configurations by loading parameters that have been saved to a storage device.

Two different types of parameter sets are saved: frame controller parameters and measurement module parameters.

To load the frame controller or module parameters that you want to use, follow the steps below.

### Loading Setup Data

#### Procedure

##### Loading Frame Controller Parameters

1. Press **FILE** to display the file operation window.
2. Press the **Func** soft key to display the file operation selection dialog box.
3. Use the arrow keys to move the cursor to Load, and press the **OK** soft key or **ENTER**.
4. Use the arrow keys to move the cursor to the storage device that you want to load the data from, and press **ENTER**.
5. Use the arrow keys to move the cursor to the parameter file that you want to load, and press the **Load Exec** soft key.

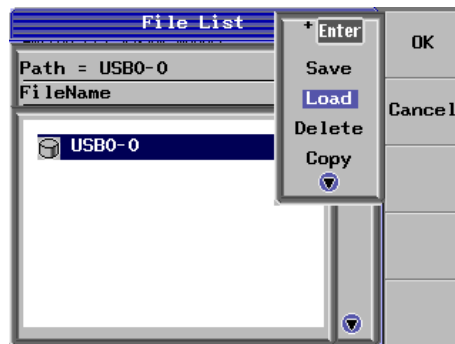

### Loading Module Parameters

To load module parameters from a storage device:

1. Press **SLOT** to make the module whose parameters you want to set the current module.
2. Press the **Menu** soft key.
3. Press the **File** soft key to display the file operation window.
4. Press the **Func** soft key to display the file operation selection dialog box.
5. Use the arrow keys to move the cursor to Save, and press the **OK** soft key or **ENTER**.
6. Use the arrow keys to move the cursor to the storage device that you want to load the data from, and press **ENTER**.
7. Use the arrow keys to move the cursor to the parameter file that you want to load, and press the **Load Exec** soft key.

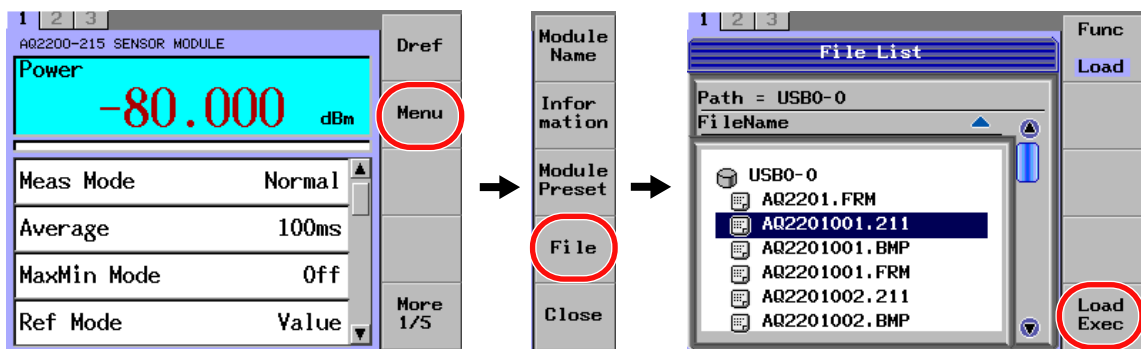

## Loading Macros

1. In the Macro display, press the **Load Macro** soft key to display the file operation window.
2. Press the **Func** soft key to display the file operation selection dialog box.
3. Use the arrow keys to move the cursor to **Save**, and press the **OK** soft key or **ENTER**.
4. Use the arrow keys to move the cursor to the storage device that you want to load the data from, and press **ENTER**.
5. Press the **Filter** soft key to display the file type selection dialog box.
6. Use the arrow keys to move the cursor to **MACRO**, and press **ENTER**.

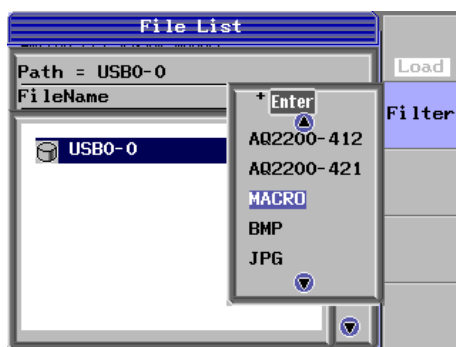

7. Press the **Macro** soft key.  
The Macro dialog box appears.
8. Use the arrow keys to move the cursor to the parameter file that you want to load, and press the **OK** soft key or **ENTER**.
9. Press the **Load Exec** soft key.

### CAUTION

Never attempt to remove the storage device while the data is being loaded from the storage device. At this time, if the storage device is removed, this may cause the storage device to break.

### French

### ATTENTION

Ne jamais essayer de retirer un dispositif de stockage pendant l'écriture de données sur ce dernier. Cela risquerait de le casser.

## Measurement Conditions for Saving and Loading

### AQ2211/AQ2212 Frame Controller

SYSTEM mode setting	GP-IB Address	Network Set
	Trigger	Display
	Volume	Image Format
Stability mode setting	Data Points	Average
	Input Trigger	Unit
	Total Time	Reference
	Modulation	
Logging mode setting	Data Points	Average
	Input Trigger	Unit
	Reference	

### AQ2200-111 DFB-LD Module

Wavelength	Attenuation
Mod Source	Mod Frequency
Line Width	WL Offset
PL Offset	Power
Unit	Module Name

### AQ2200-112 LS Module

Attenuation	Power
Linewidth	Module Name

The AQ2200-112 cannot load setup files that have been saved on an AQ2200-112 module with different channel numbers or wavelength bands.

### AQ2200-141 FP-LD Module

Attenuation	Mod Source
Mod Frequency	PL Offset
Power	Unit
Module Name	

### AQ2200-142 DUAL FP-LD Module

Attenuation1	Attenuation2
Mod Source	Mod Frequency
PL Offset1	PL Offset2
Power1	Power2
Unit	Module Name

### AQ2200-131 Grid TLS Module

Freq	Attenuation
Grid	Channel Dither
Fine Tune	PL Offset
Reference	Freq Offset
Power	Grid Mode
Grid Space	

**AQ2200-132 Grid TLS Module**

Freq1	Freq2
Grid Channel1	Grid Channel2
Fine Tune1	Fine Tune2
Reference1	Reference2
Power1	Power2
Attenuation1	Attenuation2
Dither1	Dither2
PL Offset1	PL Offset2
Freq Offset1	Freq Offset2
Grid Mode1	Grid Mode2
Grid Space1	Grid Space2

**AQ2200-201 Interface Module**

None

**AQ2200-211 Sensor Module**

Meas Mode	Average
Max/Min Mode	Data Points
Calibration	Reference
Unit	Wavelength
Disp Resolution	Modulation
Range	Analog Out
Output Trigger	Ref Mode
Module Name	

**AQ2200-215 Sensor Module**

Meas Mode	Average
Max/Min Mode	Data Points
Calibration	Reference
Unit	Wavelength
Disp Resolution	Range
Analog Out	Output Trigger
Ref Mode	Module Name

**AQ2200-221 Sensor Module**

Meas Mode	Average
Max/Min Mode	Data Points
Calibration	Reference
Unit	Wavelength
Disp Resolution	Output Trigger
Range	Ref Mode
Module Name	

**AQ2200-212 Sensor Module, AQ2200-202 Interface Module**

Meas Mode	Average
Max/Min Mode	Data Points
Calibration	Reference
Unit	Wavelength
Disp Resolution	Output Trigger
Range	Ref Mode
Event Trigger Position	Event Power Threshold
Analog Out	Module Name



## 12.3 Loading Setup Data and Macros

---

### AQ2200-222 Dual Sensor Module

Meas Mode	Average
Max/Min Mode	Data Points
Calibration	Reference
Unit	Wavelength
Disp Resolution	Output Trigger
Range	Ref Mode
Event Trigger Position	Event Power Threshold
Module Name	

### AQ2200-231/241 Optical Sensor Head

Meas Mode	Average
Max/Min Mode	Data Points
Calibration	Reference
Unit	Wavelength
Disp Resolution	Modulation
Range	Analog Out
Output Trigger	Ref Mode
Module Name	

### AQ2200-311 ATTN Module

ATT Offset	Attenuation
Wavelength	Output Start
Module Name	

### AQ2200-311A/312 ATTN Module

ATT Offset	Attenuation
Wavelength	Output Start
Module Name	

### AQ2200-331/332 ATTN Module

ATT Offset	Attenuation
Wavelength	Output Start
Power Set	Unit
Power Offset	Average
Disp Reso	Disp Mode
Module Name	

### AQ2200-342 ATTN Module

ATT Offset	Attenuation
Wavelength	Output Start
Power Set	Unit
Power Offset	Average
Disp Reso(Power)	Summary Display
Module Name	

### AQ2200-411/412/421 OSW Module

Route	
Module Name	

### Cautions about Loading of Application Parameters

For application (stability and logging) parameters you have loaded, the reproducing of the parameters is partially limited or the parameters cannot be reproduced completely according to the actually mounted sensor and/or selection of the sensor used for the application.

Sensor Configuration	Selected Sensor	Sensor Mounting Position	
A	A	A	Application parameters you have saved are reproduced completely.
A	B	A/B	If the selected sensor cannot load Average, Modulation, and Data Points, these parameters become default settings.
A	A	C	If the selected sensor cannot load Average, Modulation, and Data Points, these parameters become default settings.
A	C	—	If the selected sensor cannot load Average, Modulation, and Data Points, these parameters become default settings.
B/C	—	—	Parameters become default settings.

A: Loaded parameters are completely the same as those saved.

B: Loaded parameters are partially the same as those saved.

C: Loaded parameters are completely different from those saved.

#### Application (stability and logging) Parameters

Stability mode setting	Data Points	Average
	Input Trigger	Unit
	Total Time	Reference
	Modulation	
Logging mode setting	Data Points	Average
	Input Trigger	Unit
	Reference	

#### Note

WL Mode, Wavelength, Range Mode, and Range cannot be saved and loaded as the application parameters. These parameters are set with the selected sensors.

## 12.4 Deleting the File

### Procedure

1. Press **FILE** to display the file operation window.
2. Press the **Func** soft key to display the file operation selection dialog box.
3. Use the arrow keys to move the cursor to Delete, and press the **OK** soft key or **ENTER**.
4. Press the **Filter** soft key to display the file type selection dialog box.
5. Use the arrow keys to move the cursor to the filter type that corresponds to the type of file that you want to delete, and press **ENTER**.
6. To display a list of the files in a drive, use the arrow keys to move the cursor to the drive, and press **ENTER**.
7. To display a list of the files in a folder, use the arrow keys to move the cursor to the folder, and press **ENTER**.
8. Use the arrow keys to move the cursor to the name of the file that you want to delete, and press the **Set/Reset** soft key.  
The file switches between being selected and unselected each time you press the key.
9. To delete multiple files, repeat step 8.
10. Press the **Delete Exec** soft key to delete the selected files (or folders).  
If you do not want to delete the files, press **CANCEL**.

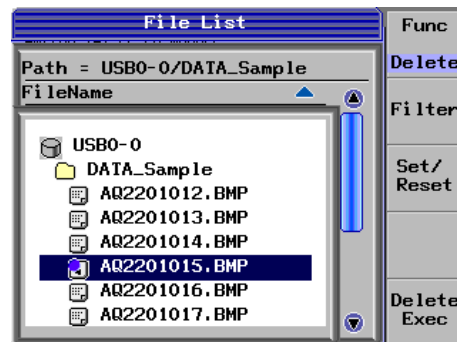

### CAUTION

Never attempt to remove the storage device while the data is being deleted from the storage device.

If the storage device is removed during data deletion, this may cause the storage device to break.

### French

### ATTENTION

Ne jamais essayer de retirer un dispositif de stockage pendant la suppression de données de ce dernier.

Cela risquerait de le casser.

## 12.5 Copying Files

### Procedure

1. Press **FILE** to display the file operation window.
2. Press the **Func** soft key to display the file operation selection dialog box.
3. Use the arrow keys to move the cursor to Copy, and press the **OK** soft key or **ENTER**.
4. Press the **Filter** soft key to display the file type selection dialog box.
5. Use the arrow keys to move the cursor to the filter type that corresponds to the type of file that you want to copy, and press **ENTER**.
6. To display a list of the files in a drive, use the arrow keys to move the cursor to the drive, and press **ENTER**.
7. To display a list of the files in a folder, use the arrow keys to move the cursor to the folder, and press **ENTER**.
8. Use the arrow keys to move the cursor to the name of the file that you want to copy, and press the **Set/Reset** soft key.  
The file switches between being selected and unselected each time you press the key.
9. To copy multiple files, repeat step 8.
10. Press the **Dest Dir** soft key to display a list of files for selecting the copy destination.
11. Use the arrow keys to move the cursor to the copy destination.
12. Press the **Copy Exec** soft key to copy the selected files.  
If you do not want to copy the files, press **CANCEL**.

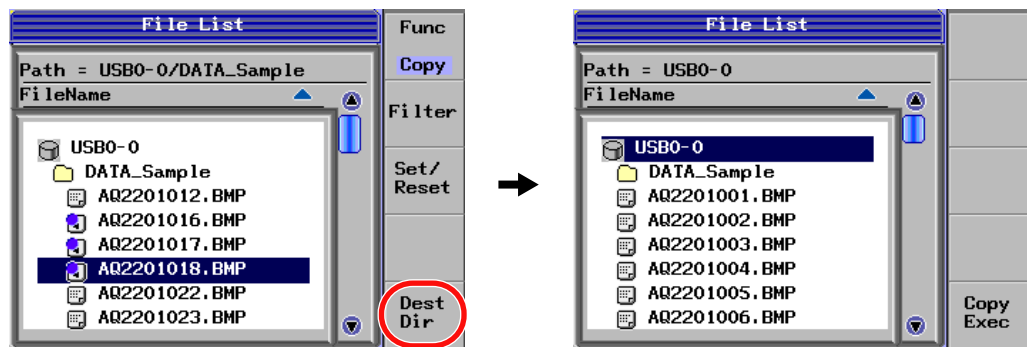

## 12.6 Creating Directories

### Procedure

1. Press **FILE** to display the file operation window.
2. Press the **Func** soft key to display the file operation selection dialog box.
3. Use the arrow keys to move the cursor to **Mk Dir**, and press the **OK** soft key or **ENTER**.

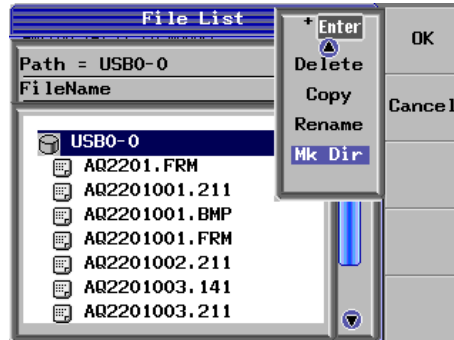

4. Use the arrow keys to move the cursor to the location where you want to create a folder, and press the **Mk Dir Exec** soft key.  
A soft keyboard appears for you to use to enter the folder name.
5. Enter the folder name, and press the **Commit** soft key.

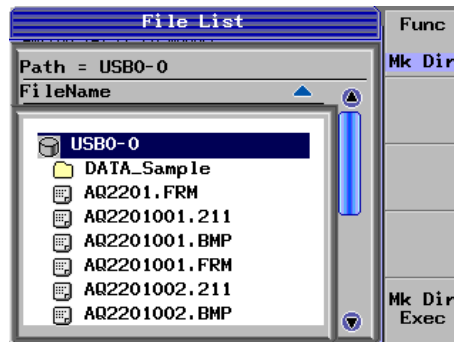

## 12.7 Editing File and Directory Names

### Procedure

1. Press **FILE** to display the file operation window.
2. Press the **Func** soft key to display the file operation selection dialog box.
3. Use the arrow keys to move the cursor to **Rename**, and press the **OK** soft key or **ENTER**.
4. Press the **Filter** soft key to display the file type selection dialog box.
5. Use the arrow keys to move the cursor to the file type that includes the file whose name you want to change, and press **ENTER**.
6. To display a list of the files in a drive, use the arrow keys to move the cursor to the drive, and press **ENTER**.
7. To display a list of the files in a folder, use the arrow keys to move the cursor to the folder, and press **ENTER**.
8. Use the arrow keys to move the cursor to the file name that you want to change, and press the **Rename Exec** soft key.  
A soft keyboard appears for you to use to change the file name.
9. Enter the file name, and press the **Commit** soft key.

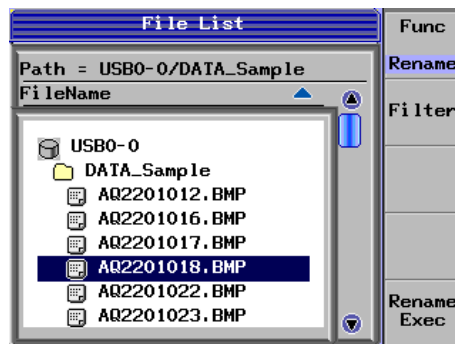

## 13.1 Setup Screen

### SYSTEM Screen

#### Procedure

1. Press **SYSTEM** to display the SYSTEM screen.
2. Use the arrow keys to move the cursor to a setup item, and press the **Select** soft key or **ENTER**.

The setup screens for various features appear.

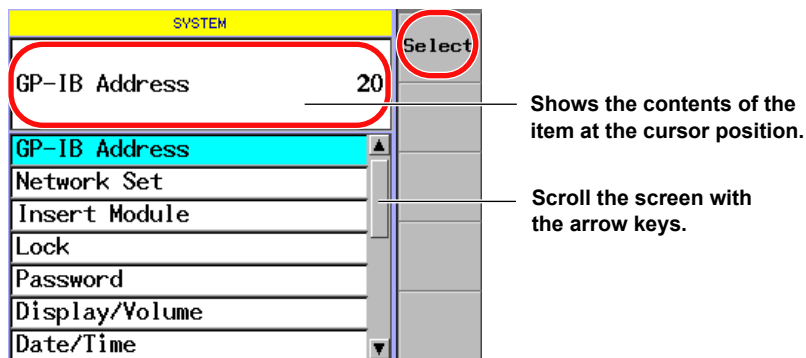

#### Explanation

In the SYSTEM screen, you can check and change the following system parameters.

- GP-IB Address
- Network Set (network settings)
- Insert Module (redetect modules)
  - For details, see section 4.3 in the user's manual [Startup Guide] (IM 735101-01EN).
- Lock (lock laser output)\*
- Password
- Display/Volume (Sound volume)
- Date (Year-Month-Day)/Time
- Condition Check (check the device condition)
- Information (display device information)
  - For details, see section 4.4 in the user's manual [Startup Guide] (IM 735101-01EN).
- Error View
- Soft Version View
  - For details, see section 4.4 in the user's manual [Startup Guide] (IM 735101-01EN).
- Module Update
  - For details, see section 4.4 in the user's manual [Startup Guide] (IM 735101-01EN).
- Trigger
  - For details, see chapter 8 in the user's manual [Application Operation] (IM 735101-04EN).
- Key Check (check key operation)
- Image Format (set the screen capture file format)

\* Laser output locking is only valid for the light source modules (AQ2200-111, 112, 131, 132, 136, 141, 142) and the XFP interface module (AQ2200-641).

## 13.2 Configuring GP-IB Settings

### Changing the GP-IB Address

When two or more number of devices are connected, a different GP-IB address needs to be set for each device.

#### Procedure

1. Press **SYSTEM** to display the SYSTEM screen.
2. Move the cursor using the arrow keys to GP-IB Address and press the **Select** soft key or **ENTER**.  
The GP-IB Address dialog box appears.
3. With the numeric keypad, or the arrow keys, change the address.
4. After inputting the new address, press the **OK** soft key or **ENTER**.

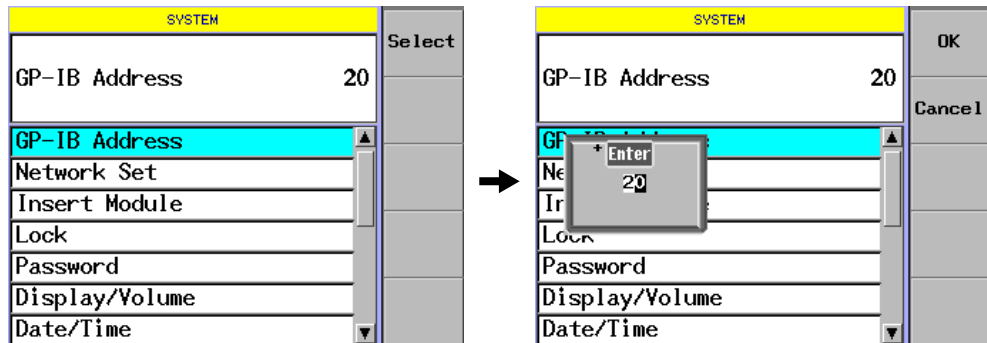

#### Note

You can set the address to a number from 0 to 30. The initial value has been set at "20" before shipment from the factory.



## 13.3 Configuring Ethernet Settings

### Changing the Ethernet Address

A different Ethernet address needs to be set for each unit in order to identify the units to be connected to the network.

#### Procedure

1. Press **SYSTEM** to display the SYSTEM screen.
2. Move the cursor using the arrow keys to Network Set and press the **Select** soft key or **ENTER**.  
The Network Set dialog box appears.
3. Use the arrow keys to move the cursor to a setup item, and press **ENTER**.  
A numeric entry dialog box or an on/off selection dialog box will appear, depending on the setup item selected.
4. Use the numeric keypad or the arrow keys to change the value, and press the **OK** soft key or **ENTER**.
5. To select on or off, move the cursor to the option that you want to select, and press the **OK** soft key or **ENTER**.
6. After you have entered all of the parameters, press the **Close** soft key.

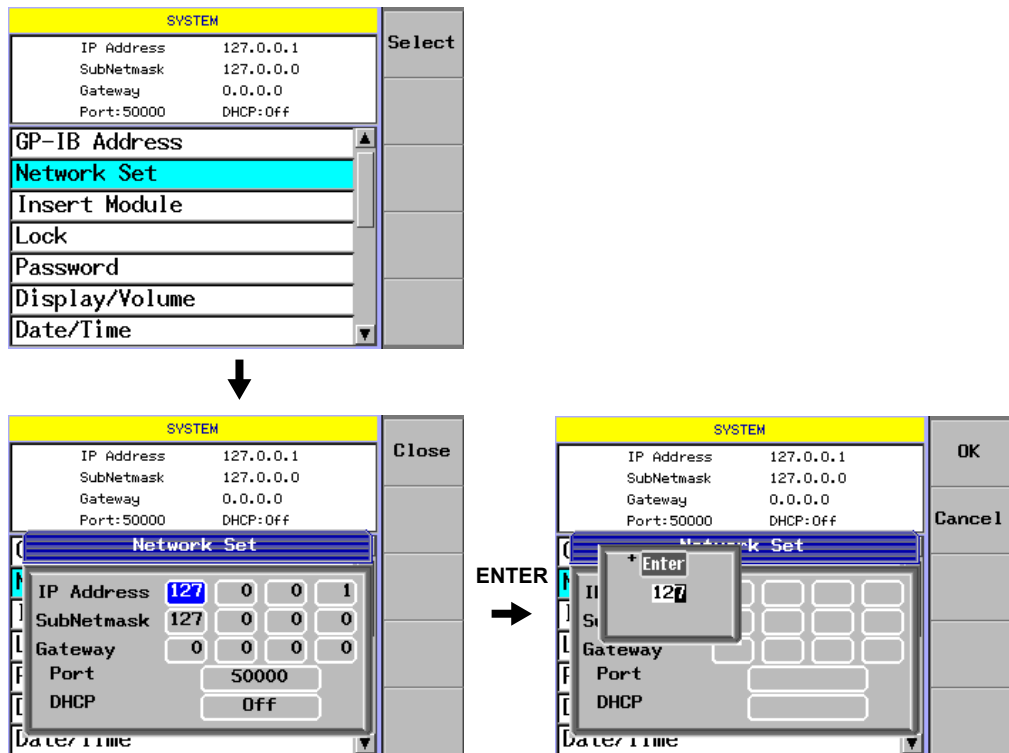

#### Note

- To make the numeric values you have input valid, turn OFF the power, and then turn it ON again.
- When DHCP is set to On, IP Address, SubNetmask, and Gateway cannot be set.

## 13.4 Locking the Laser Output

### Locking the Laser Output

By locking the laser output, the laser light source cannot emit a laser beam. It is possible to protect the operation by a third person.

#### Procedure

1. Press **SYSTEM** to display the SYSTEM screen.
2. Use the arrow keys to move the cursor to Lock, and press the **Select** soft key or **ENTER**.

The Lock dialog box appears.

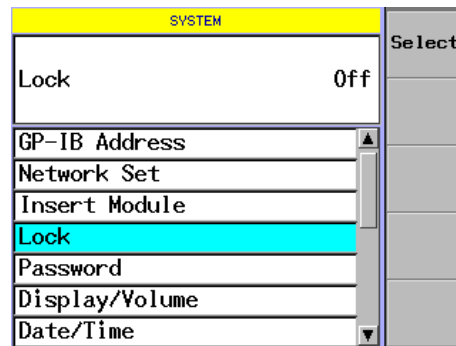

#### Setting the Password

3. Use the arrow keys to move the cursor to Password, and press **ENTER**.  
The Password input display appears.
4. Use the numeric keypad to enter a four-digit password, and press **ENTER**.

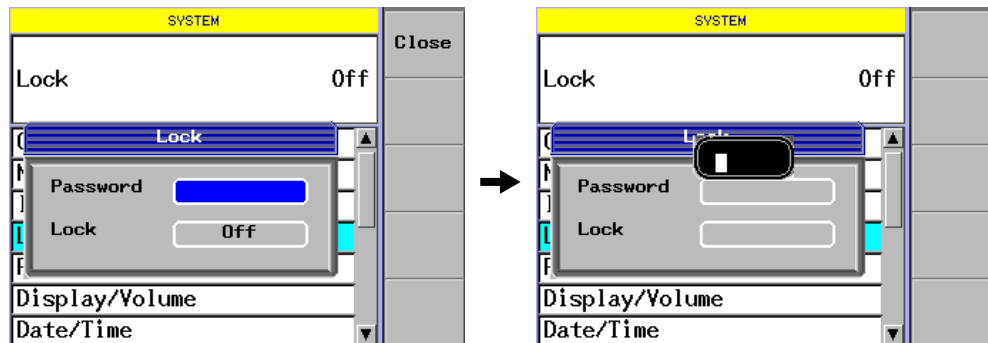

### Setting the Lock

5. Use the arrow keys to move the cursor to Lock, and press **ENTER**.  
The Lock dialog box appears.
6. Use the arrow keys to move the cursor to ON or OFF, and press the **OK** soft key or **ENTER**.

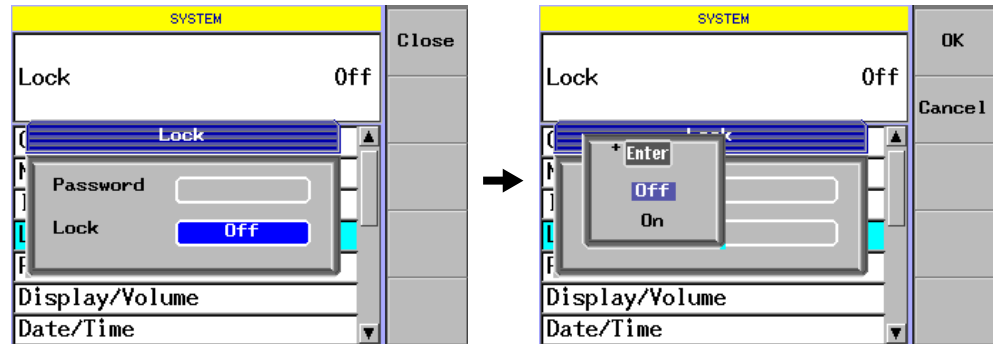

### Note

- This parameter is valid when the following modules are installed.

Model	Name
AQ2200-111	DFB-LD Module
AQ2200-112	LS Module
AQ2200-141	FP-LD Module
AQ2200-142	DUAL FP-LD Module
AQ2200-131	Grid TLS Module
AQ2200-132	Grid TLS Module
AQ2200-136	TLS Module
AQ2200-641	XFP I/F Module

- When the interlock connector in the rear panel of AQ2211/AQ2212 frame controller becomes an opening (state not connected), Lock is set to On. To release the interlock, connect the included Interlock Connector Plug (A1288JA) to the interlock connector terminal and Lock is set to Off. For details, see section 2.9 “Unlocking the Laser Output” in [Startup Guide] (IM 735101-01EN).
- When the interlock connector is open, “Lock” is displayed in the “Opt” or “Output” field on the Light Source modules and XFP Interface module (XFP transceiver installed).

### Setting or Changing the Password

You can set a password intended to lock or cancel the laser output.

#### Procedure

1. Press **SYSTEM** to display the SYSTEM screen.
2. Use the arrow keys to move the cursor to Password, and press the **Select** soft key or **ENTER**.  
The Password dialog box appears.

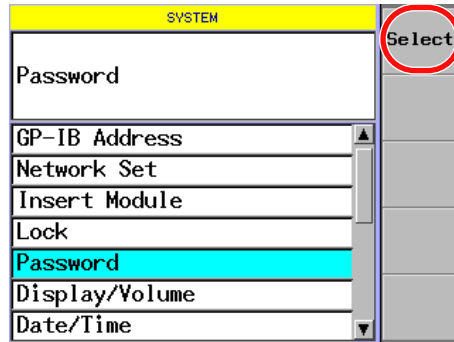

3. Use the arrow keys to move the cursor to Old Password, and press **ENTER**.  
The Password input display appears.
4. Use the numeric keypad to enter a four-digit password, and press **ENTER**.

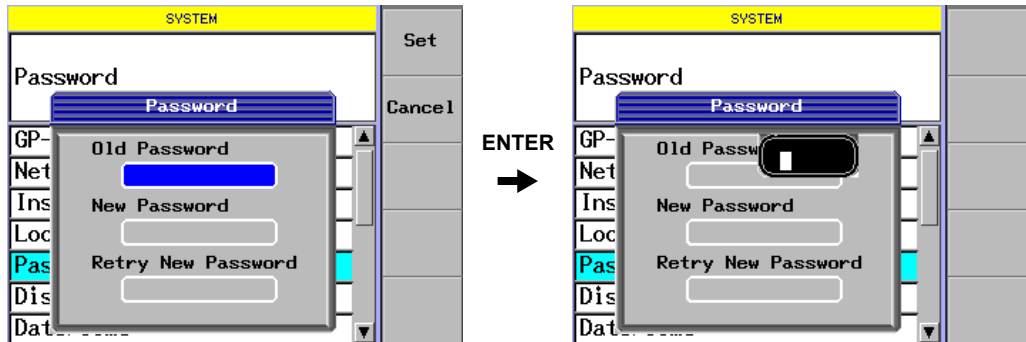

5. Use the arrow keys to move the cursor to New Password, and press **ENTER**.  
The Password input display appears.
6. Use the numeric keypad to enter a new password (4-digit numeric value ranging from "0000" to "9999"), and press **ENTER**.
7. Use the arrow keys to move the cursor to Retry New Password, and press **ENTER**.  
The Password input display appears.

8. Enter the same password you have input in step 6 again, and then press **ENTER**.

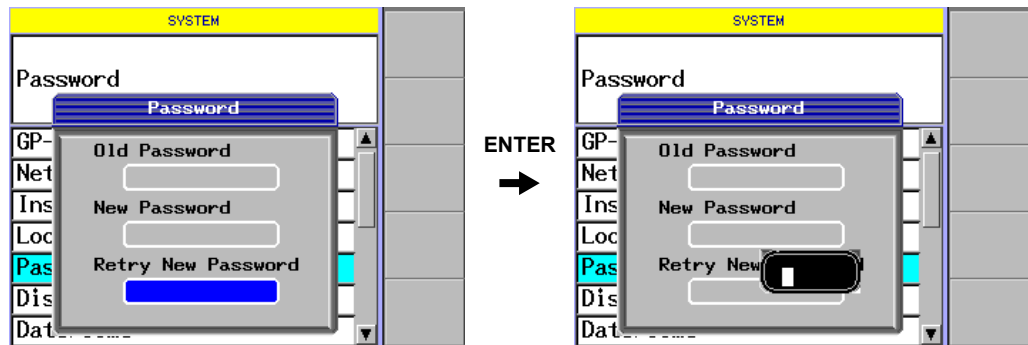

9. Press the **Set** soft key or **ENTER**.  
The new password setup is then completed.

### CAUTION

If the password is not matched, you cannot perform the laser output lock operation.  
If you have changed the password, you must record this password.  
If you forget the password, contact your local sales dealer or YOKOGAWA's sales branch office.

### French

### ATTENTION

Si le mot de passe est erroné, le verrouillage de la sortie laser ne peut être effectué. Si le mot de passe a été modifié, il doit être enregistré. En cas d'oubli du mot de passe, contacter le représentant local ou le bureau des ventes de YOKOGAWA.

### Note

The password has been set at "1234" before shipment from the factory.

## 13.5 Configuring the Display and the Volume

### Adjusting the Display

You can adjust the back-light of the display.

#### Procedure

1. Press **SYSTEM** to display the SYSTEM screen.
2. Move the cursor using the arrow keys to Display/Volume and press the **Select** soft key or **ENTER**.

The Display/Volume dialog box appears.

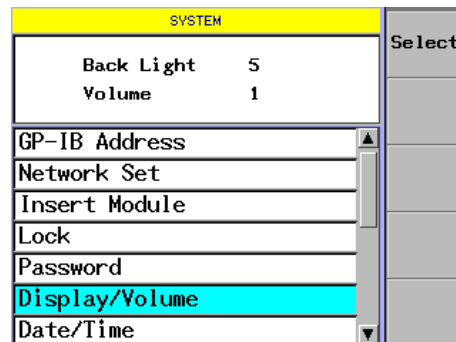

3. Move the cursor to Back Light with the arrow keys and press **ENTER**.  
A numeric entry dialog box appears.
4. Change the numeric value with the numeric keypad or the arrow keys, and press **ENTER**.

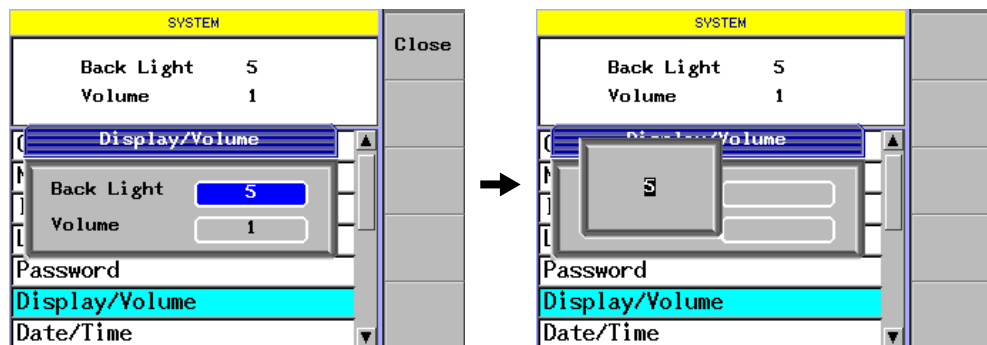

#### Note

You can set the backlight brightness to a value from 1 to 8. The factory default setting is 5.

## Changing the Buzzer Sound Volume

In the key operation, when the key you have pressed is recognized, the buzzer will sound. You can adjust this buzzer sound volume.

### Procedure

1. Press **SYSTEM** to display the SYSTEM screen.
2. Move the cursor using the arrow keys to Display/Volume and press the **Select** soft key or **ENTER**.  
The Display/Volume dialog box appears.

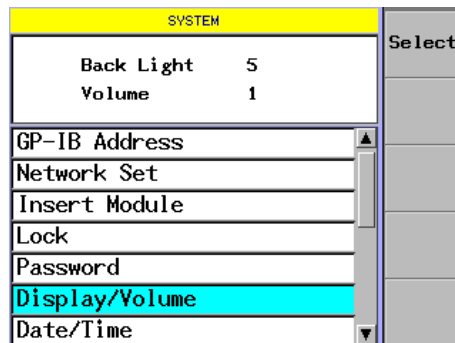

3. Move the cursor to Volume with the arrow keys and press **ENTER**.  
A numeric entry dialog box appears.
4. Change the numeric value with the numeric keypad or the arrow keys, and press **ENTER**.

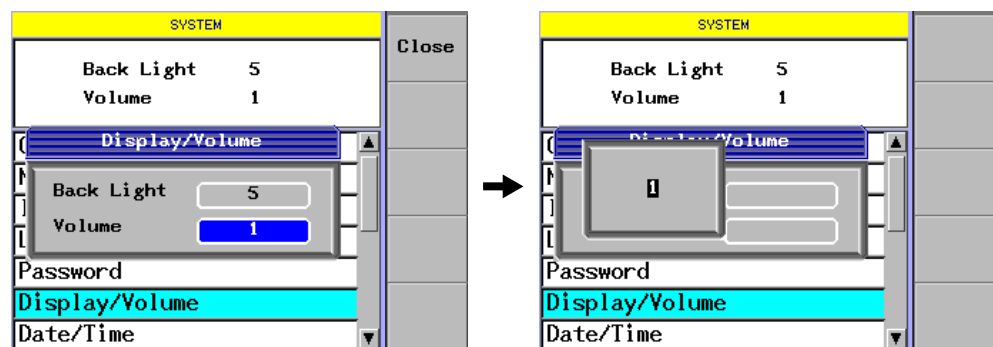

### Note

- You can set the buzzer volume to a value from 0 to 9. The factory default setting is 1. To turn the buzzer off, set the volume to 0.
- The buzzer sound volume for when an AQ2200-601 10 Gbit/s BERT module detects an error is set in the BERT module's DETAIL screen. For details, see page 9-35.

## 13.6 Setting the Date and Time

### Changing the Date and Time

#### Procedure

1. Press **SYSTEM** to display the SYSTEM screen.
2. Move the cursor using the arrow keys to Date/Time and press the **Select** soft key or **ENTER**.

The Date/Time dialog box appears.

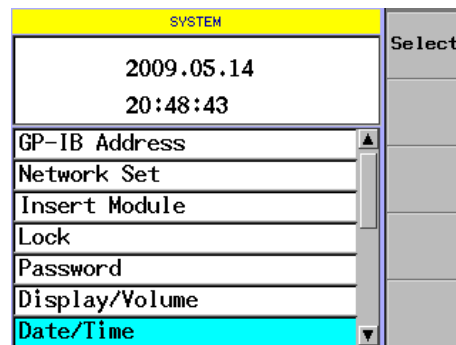

3. Use the arrow keys to move the cursor to a setup item, and press **ENTER**.  
A numeric entry dialog box appears.
4. Use the numeric keypad or the arrow keys to enter a value, and press **ENTER**.
5. After you have entered the date and time, press the **Set** soft key.

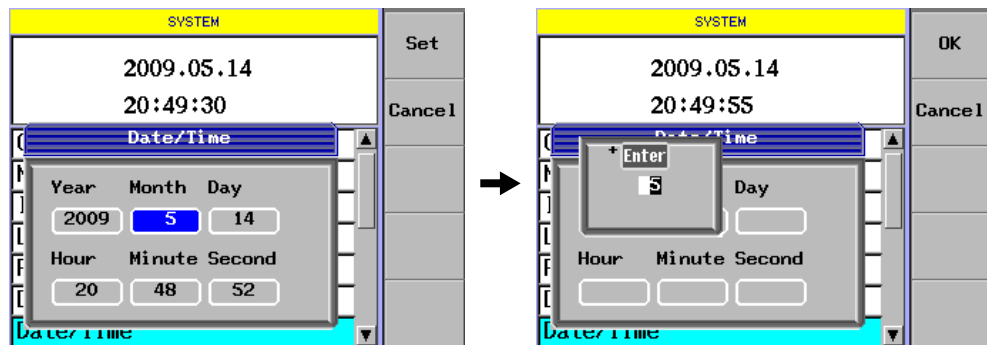

#### Note

If you try to set a day that does not exist on the calendar, an error message will appear when you press the Set soft key.



## 13.7 Displaying Device Information

### Checking the Frame Conditions

You can check the condition of the fan.

#### Procedure

1. Press **SYSTEM** to display the SYSTEM screen.
2. Use the arrow keys to move the cursor to Condition Check.  
The condition of the fan is indicated at the top of the screen.

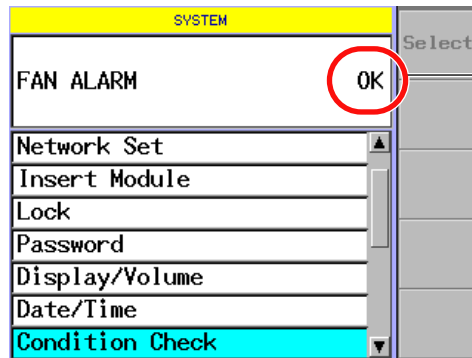

Check results are shown.  
OK: Functioning properly

### CAUTION

When the error screen is displayed, the fan is not operating properly. Turn off the power of the frame controller.

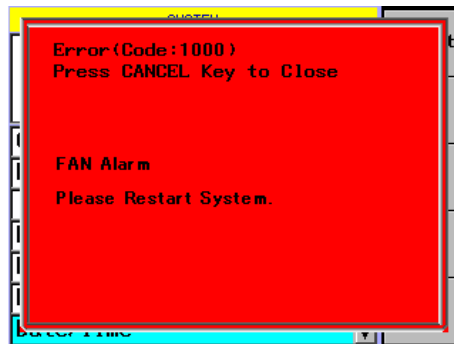

Check the fan for entry of any foreign matter, and then turn it ON again.  
If the error screen still reappears, contact your local sales dealer or YOKOGAWA's sales branch office.

### French

---

#### **ATTENTION**

Lorsque l'écran d'erreur s'affiche, le ventilateur ne fonctionne pas correctement.  
Mettre le contrôleur hors tension.

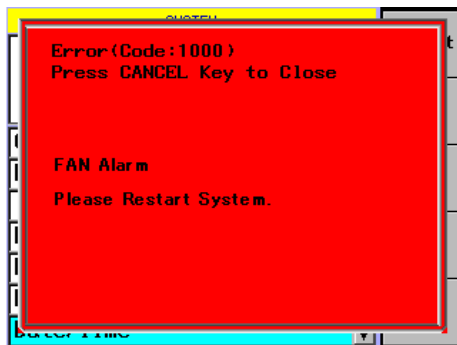

Vérifier l'absence de corps étranger dans le ventilateur, puis remettre le contrôleur sous tension. Si l'écran d'erreur s'affiche de nouveau, contacter le représentant local ou le bureau des ventes de YOKOGAWA.

---

## Displaying Error Information

### Procedure

1. Press **SYSTEM** to display the SYSTEM screen.

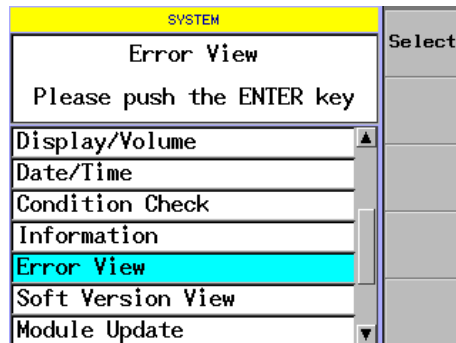

2. Use the arrow keys to move the cursor to Error View, and press the **Select** soft key or **ENTER**.

The frame error information display appears.

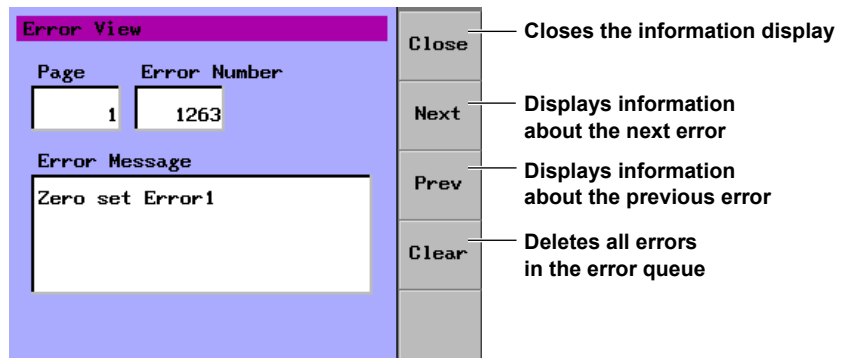

3. Press the **Close** soft key.  
The information display closes.

### Note

All the errors in the error queue are deleted with Off/On of the power supply.

## Checking Key Operation

### Procedure

1. Press **SYSTEM** to display the SYSTEM screen.
2. Use the arrow keys to move the cursor to Key Check, and press the **Select** soft key or **ENTER**.  
The Key Check display appears.
3. When you press a key on the frame, the background color of the key changes.
4. Follow the same procedure to check the operation of the other keys.
5. To close the Key Check display and stop checking key operation, press CANCEL.

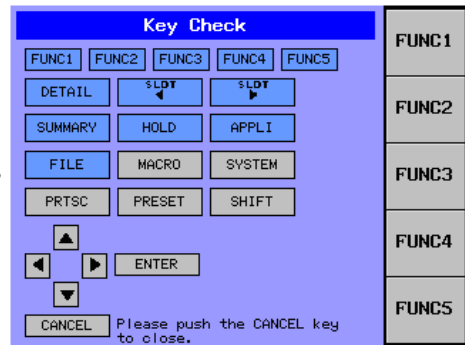
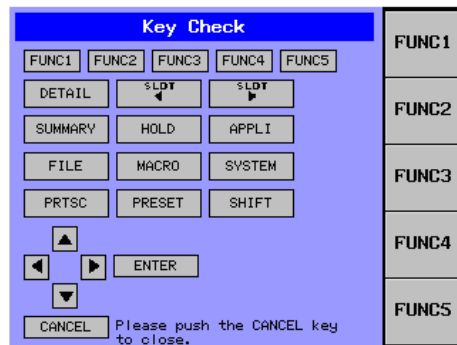
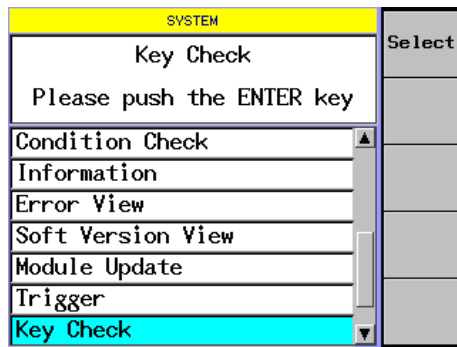

## Setting the File Type

You can set the file format of the screen capture that you save with the print screen feature.

### Procedure

1. Press **SYSTEM** to display the SYSTEM screen.
2. Use the arrow keys to move the cursor to Image Format, and press the **Select** soft key or **ENTER**.  
The file format selection dialog box appears.
3. Use the arrow keys to move the cursor to BMP, JPG, or PNG, and press the **OK** soft key or **ENTER**.

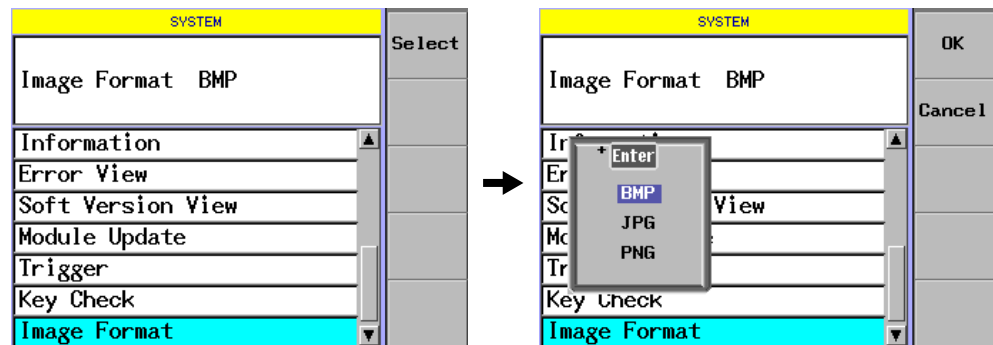

## Changing Display Module Names

You can assign a name to each slot that corresponds to the function of its module.

### Procedure

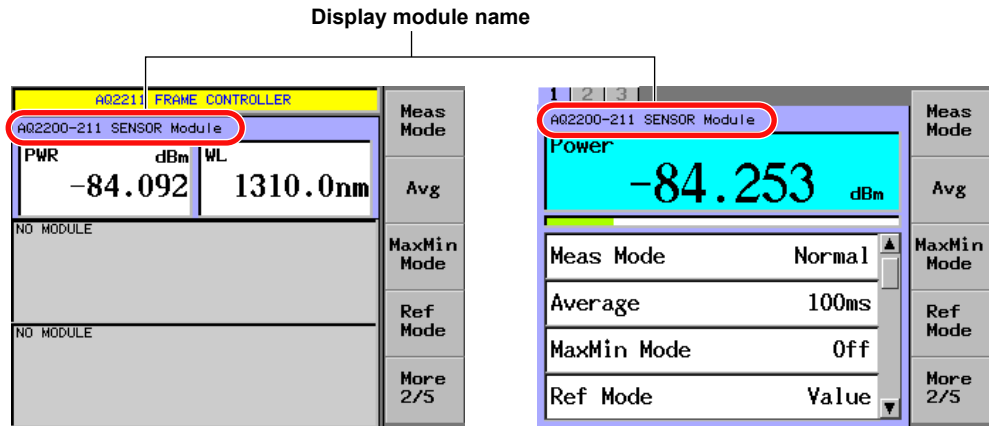

1. Press **SLOT** to make the module whose name you want to change the current module.
2. Press the **Menu** soft key.  
The module control soft keys appear.

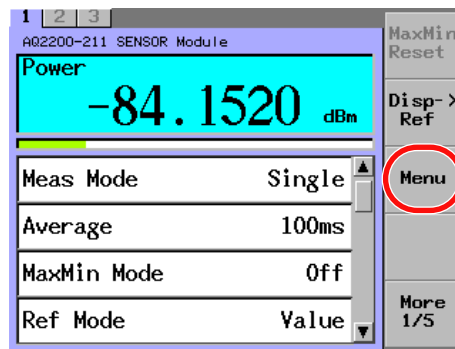

3. Press the **Module Name** soft key. A software keyboard appears.

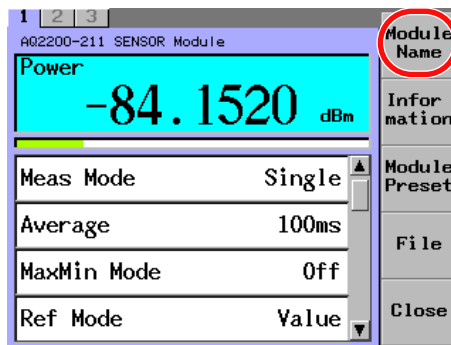

4. Use the arrow keys to input the text.  
For details on entering characters, see section 2.4 "Inputting a Character String".

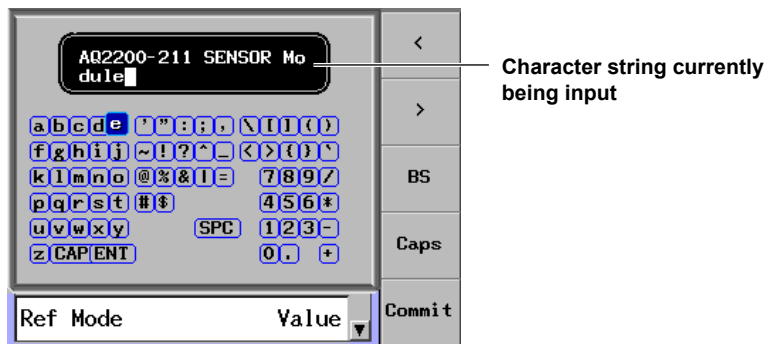

**Note**

- The specified module name is retained even after you turn the power off, but the module's name will return to its default (the product name) if you change the slot.
- The following modules can change the display module names.
  - AQ2200-111, 112, 131, 132, 136, 141, 142
  - AQ2200-202, 211, 215, 221, 212, 222, 231, 241, 271
  - AQ2200-311, 311A, 312, 331, 332, 342
  - AQ2200-411, 412, 421

## 13.8 Returning the Initial Settings

### Initializing the Frame and Modules

Various settings of the frame controller and mounted module are returned to the initial values. For details about the default and the initialized item, see the “List of Default Settings” (page 13-21).

#### Procedure

1. Press **PRESET** to display a dialog box for selecting what to initialize.

### Returning Only the Frame Controller to the Initial Values

2. Use the arrow keys to move the cursor to Frame Controller, and press **ENTER**.

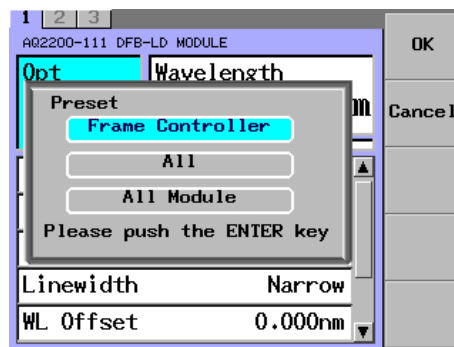

### Note

You cannot initialize the settings while an application is running.

The following message will appear on the screen.

Error 1033 : Execution Error

### Returning All the Frame Controller and Mounted Modules to the Initial Values

2. Use the arrow keys to move the cursor to All, and press **ENTER**.

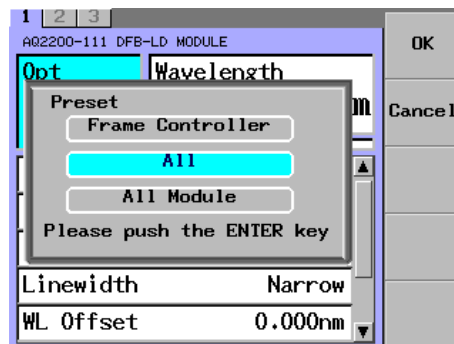



### Returning All the Mounted Modules to the Initial Values

- Use the arrow keys to move the cursor to All Module, and press **ENTER**.

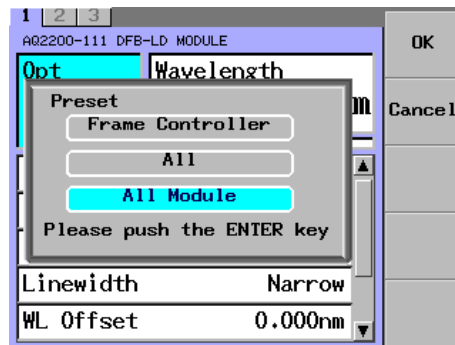

#### Note

You cannot initialize the settings while an application is running.

The following message will appear on the screen.

Error 1033 : Execution Error

**Returning Individual Mounted Module to the Initial Values (Does not apply to some modules)**

1. Press **SLOT** to make the module you want to initialize the current module.
2. Press the **Menu** soft key.  
The module control soft keys appear.

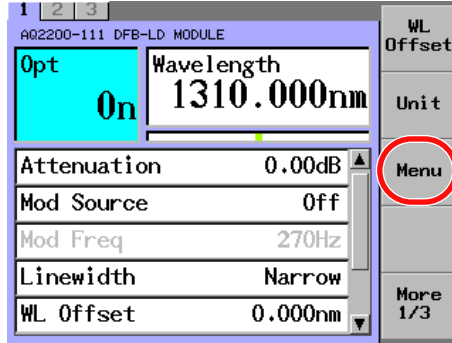

3. Press the **Module Preset** soft key.  
When Executing displaying disappear, the initialization is completed.

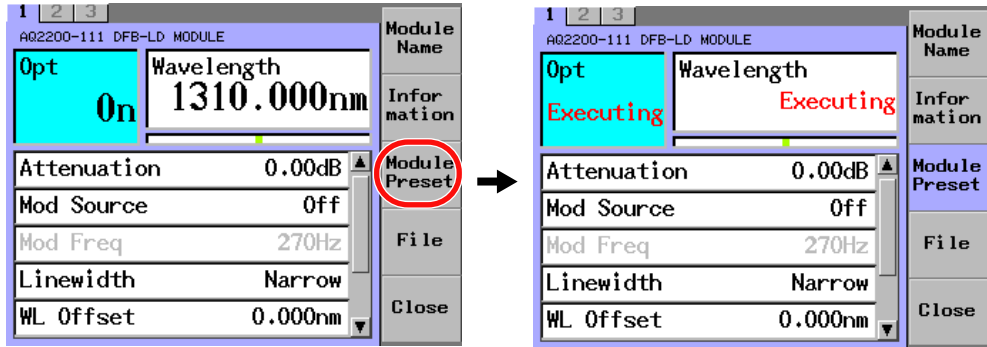

**Note**

- During initialization, "Executing" is displayed.
- For the procedures for initializing the following modules, see the sections listed below.
  - 10 Gbit/s Optical Modulator module: Section 9.3
  - 10 Gbit/s Optical Modulator module: Section 9.4
  - SG module: Section 10.1
  - XFP Interface module: Section 11.1
  - Transceiver I/F module: Section 11.2

## List of Default Settings

### AQ2211/AQ2212 Frame Controller Default Settings

Item		Set Value	
Display	Back Light	5	
Volume		1	
Screen mode		SUMMARY screen	
Stability	Selected Modules	None	
	Average <sup>1</sup>	100 ms	
	Total Time <sup>1</sup>	00:10:00	
	Data Points <sup>1</sup>	600	
	WL Mode <sup>2</sup>	Depending on the selected sensor	
	Wavelength <sup>2</sup>	850 nm or 1310 nm	
	Range Mode <sup>2</sup>	Auto	
	Range <sup>2</sup>	Auto	
	Unit <sup>1</sup>	dBm	
	Ref Mode <sup>1</sup>	Value	
	Reference <sup>1</sup>	-30.0000 dBm	
	Input Trigger <sup>1</sup>	Ignore	
	Modulation <sup>1</sup>	CW	
Logging	Selected Modules	None	
	Average <sup>1</sup>	100 ms	
	Data Points <sup>1</sup>	600	
	WL Mode <sup>2</sup>	Depending on the selected sensor	
	Wavelength <sup>2</sup>	850 nm or 1310 nm	
	Range Mode <sup>2</sup>	Depending on the selected sensor	
	Range <sup>2</sup>	Depending on the selected sensor	
	Unit <sup>1</sup>	dBm	
	Ref Mode <sup>1</sup>	Value	
	Reference <sup>1</sup>	-30.0000 dBm	
	Input Trigger <sup>1</sup>	Ignore	
	ORL	Ref	14.7 dB
		Average	1 s
Wavelength		Default wavelength of the selected light source	
ORL display resolution		1/10	
IL display resolution		1/100	
Selected Modules		In order of installed sensors starting from the lowest slot number	

1 Common parameters

2 Individual parameters

## 13.8 Returning the Initial Settings

---

### AQ2200-111 DFB-LD Module Default Settings

Item	Set Value
Opt	OFF
Wavelength	Specified wavelength
Attenuation	0.00 dB
Mod Source	OFF
Mod Frequency	270 Hz
Line Width	Narrow
WL Offset	0.000 nm
Unit	nm, dBm
PL Offset	0.00 dB
Display module name	AQ2200-111 DFB-LD MODULE

### AQ2200-112 LS Module Default Settings

Item	Set Value
Opt	OFF
Attenuation	0.00 dB
Line Width	Narrow
Power	Module's maximum power
Display module name	AQ2200-112 LS MODULE

### AQ2200-141 FP-LD Module Default Settings

Item	Set Value
Opt	OFF
Attenuation	0.00 dB
Mod Source	OFF
Mod Frequency	270 Hz
Unit	nm, dBm
PL Offset	0.00 dB
Display module name	AQ2200-141 FP-LD MODULE

### AQ2200-142 DUAL FP-LD Module Default Settings

Item	Set Value
Opt1,2	OFF
Attenuation1,2	0.00 dB
Mod Source	OFF
Mod Frequency	270 Hz
Unit	nm, dBm
PL Offset	0.00 dB
Display module name	AQ2200-142 DUAL FP-LD MODULE

**AQ2200-131 Grid TLS Module Default Settings**

Item	Set Value
Opt	Off
Freq	193.1 THz (C-Band), 190.0 THz (L-Band)
Grid Channel	31 (C-Band), 0 (L-Band)
Fine Tune	0.000 GHz
Grid Space	100 GHz
Reference	190.0000 THz
Power	Maximum output
Attenuation	0 dB
Dither	Off
DitherF	200 MHz
DitherA	2.0%
PL Offset	0.00 dB
Freq Offset	0.0 GHz
Grid Mode	On
Display module name	AQ2200-131 GRID TLS MODULE

**AQ2200-132 Grid TLS Module Default Settings**

Item	Set Value
Opt1, 2	Off
Freq1, 2	193.1 THz (C-Band), 190.0 THz (L-Band)
Grid Channel1, 2	31 (C-Band), 0 (L-Band)
Fine Tune1, 2	0.000 GHz
Grid Space1, 2	100 GHz
Reference1, 2	190.0000 THz
Power1, 2	Maximum output
Attenuation1, 2	0 dB
Dither1, 2	Off
DitherF1, 2	200 MHz
DitherA1, 2	2.0%
PL Offset1, 2	0.00 dB
Freq Offset1, 2	0.0 GHz
Grid Mode1, 2	On
Display module name	AQ2200-132 GRID TLS MODULE

**AQ2200-136 TLS Module Default Settings**

Item	Set Value
Opt	OFF
Wavelength	1501.743
$\Delta f$	+0.0 GHz
WL Ref	1501.743
Start WL	1440.000 nm
Stop WL	1640.000 nm
Step WL	0.500 nm
Power	Since the minimum output level value within the setting range is displayed, each module has a different initial value.
Sweep Cycles	1
Sweep Interval	0 sec
Dwell Time	0.1 sec
Sweep Mode	Continuous
Sweep Speed	50.0 nm/sec
Linewidth	Narrow
Input Trig	Ignore
Output Trig	Disable
MWL Settle	OFF
OSA Sync	ON
Unit (Wavelength)	nm
Unit (Power)	dBm
Display module name	AQ2200-136 TLS MODULE

## 13.8 Returning the Initial Settings

---

### AQ2200-211 Sensor Module Default Settings

Item	Set Value
Measure Mode	Normal
Average	100 ms
Data Points	1000
Reference Mode	Value
Reference (dBm)	-30.0000 dBm
Calibration	0.0000 dB
Wavelength	1310.0 nm
Unit	dBm
Display Resolution	1/10000
Range Mode	AUTO
Modulation	CW
Output Trigger	Disable
Analog Out	AUTO
MaxMin Mode	Off
Maximum Level	+13 dBm
Power Range	24 dB
Display module name	AQ2200-211 SENSOR MODULE

### AQ2200-215 Sensor Module Default Settings

Item	Set Value
Measure Mode	Normal
Average	100 ms
Data Points	1000
Reference Mode	Value
Reference (dBm)	-30.0000 dBm
Calibration	0.0000 dB
Wavelength	1310.0 nm
Unit	dBm
Display Resolution	1/1000
Range Mode	AUTO
Output Trigger	Disable
Analog Out	AUTO
MaxMin Mode	Off
Maximum Level	+33 dBm
Power Range	24 dB
Display module name	AQ2200-215 SENSOR MODULE

### AQ2200-221 Sensor Module Default Settings

Item	Set Value
Measure Mode	Normal
Average	100 ms
Data Points	1000
Reference Mode	Value
Reference (dBm)	-30.0000 dBm
Calibration	0.0000 dB
Wavelength	1310.0 nm
Unit	dBm
Display Resolution	1/1000
Range Mode	AUTO
Output Trigger	Disable
MaxMin Mode	Off
Display module name	AQ2200-221 SENSOR MODULE

**AQ2200-212 Sensor Module Default Settings**

Item	Set Value
Measure Mode	Normal
Average	100 ms
Data Points	1000
Reference Mode	Value
Reference (dBm)	-30.0000 dBm
Calibration	0.0000 dB
Wavelength	1310.0 nm
Unit	dBm
Display Resolution	1/1000
Range Mode	AUTO
Output Trigger	Disable
Analog Out	Auto Power
MaxMin Mode	Off
Maximum Level	—
Power Range	—
Maximum Voltage	2 V
Display module name	AQ2200-212 SENSOR MODULE

**AQ2200-222 Dual Sensor Module Default Settings**

Item	Set Value
Measure Mode	Normal
Average	100 ms
Data Points	1000
Reference Mode	Value
Reference (dBm)	-30.0000 dBm
Calibration	0.0000 dB
Wavelength	1310.0 nm
Unit	dBm
Display Resolution	1/1000
Range Mode	AUTO
Output Trigger	Disable
MaxMin Mode	Off
Display module name	AQ2200-222 DUAL SENSOR MODULE

**AQ2200-231 Optical Sensor Head Default Settings**

Item	Set Value
Measure Mode	Normal
Average	100 ms
Data Points	1000
Reference Mode	Value
Reference (dBm)	-30.0000 dBm
Calibration	0.0000 dB
Wavelength	1310.0 nm
Unit	dBm
Display Resolution	1/10000
Range Mode	AUTO
Modulation	CW
Output Trigger	Disable
Analog Out	AUTO
MaxMin Mode	Off
Maximum Level	+13.0 dBm
Power range	24 dB
Display module name	AQ2200-231 SENSOR HEAD

## 13.8 Returning the Initial Settings

---

### AQ2200-232 Optical Sensor Head Default Settings

Item	Set Value
Measure Mode	Normal
Average	100 ms
Data Points	1000
Reference Mode	Value
Reference (dBm)	-30.0000 dBm
Calibration	0.0000 dB
Wavelength	1310.0 nm
Unit	dBm
Display Resolution	1/1000
Range Mode	AUTO
Output Trigger	Disable
Analog Out	Auto Power
MaxMin Mode	Off
Maximum Level	+13.0 dBm
Power range	24 dB

### AQ2200-241 Optical Sensor Head Default Settings

Item	Set Value
Measure Mode	Normal
Average	100 ms
Data Points	1000
Reference Mode	Value
Reference (dBm)	-30.0000 dBm
Calibration	0.0000 dB
Wavelength	850.0 nm
Unit	dBm
Display Resolution	1/10000
Range Mode	AUTO
Modulation	CW
Output Trigger	Disable
Analog Out	AUTO
MaxMin Mode	Off
Maximum Level	+13 dBm
Power range	24 dB
Display module name	AQ2200-241 SENSOR HEAD

### AQ2200-242 Optical Sensor Head Default Settings

Item	Set Value
Measure Mode	Normal
Average	100 ms
Data Points	1000
Reference Mode	Value
Reference (dBm)	-30.0000 dBm
Calibration	0.0000 dB
Wavelength	850.0 nm
Unit	dBm
Display Resolution	1/1000
Range Mode	AUTO
Output Trigger	Disable
Analog Out	Auto Power
MaxMin Mode	Off
Maximum Level	+13 dBm
Power range	24 dB



**AQ2200-311 ATTN Module Default Settings**

Item	Set Value
Output	Disable
Attenuation	0.000 dB
Wavelength	1550.0 nm
ATT Offset	0.000 dB
Output Start	Disable
Display module name	AQ2200-311 ATTN MODULE

**AQ2200-311A/312 ATTN Module Default Settings**

Item	Set Value
Output	Disable
Attenuation	0.000 dB
Wavelength	Multi mode 850.0 nm Single mode 1550.0 nm
ATT Offset	0.000 dB
Output Start	Disable
Display module name	AQ2200-311A ATTN MODULE/AQ2200-312 ATTN MODULE

**AQ2200-331/332 ATTN Module Default Settings**

Item	Set Value
Output	Disable
Attenuation	0.000 dB
Wavelength	Multi mode 850.0 nm Single mode 1550.0 nm
ATT Offset	0.000 dB
Unit	dBm
Power Offset	0.000 dB
Average	100 ms
Output Start	Disable
Disp Reso	1/1000
Disp Mode	ATT
Display module name	AQ2200-331 ATTN MODULE/AQ2200-332 ATTN MODULE

**AQ2200-342 DUAL ATTN Module Default Settings**

Item	Set Value
Attenuation	0.00 dB
Wavelength	1550 nm
Output	Disable
ATT Offset	0.00 dB
Power Set	-50.0 dBm
APC	Disable
Power Offset	0.00 dB
Average	100 ms
MaxMin Mode	Off
Ctrl Speed	Max
Disp Reso	1/100 (set with the cursor on Power)
Smry Disp	ATT
Output Start	StartUp Disable
Power Status Threshold	0.5 dB (set with a communication command)
Unit	dBm
Display module name	AQ2200-342 DUAL ATTN MODULE

## 13.8 Returning the Initial Settings

### AQ2200-411 OSW Module Default Settings

Item	Set Value
Route	A-1
Display module name	AQ2200-411 OSW MODULE

### AQ2200-412 OSW Module Default Settings

Item	Set Value
Route	A-1
Display module name	AQ2200-412 OSW MODULE

### AQ2200-421 OSW Module Default Settings

Item	Set Value
Route	When Both Devices are A-1 (1 × 2)
Route	When Both Devices are A-1 and B-2 (2 × 2)
Display module name	AQ2200-421 OSW MODULE

### AQ2200-601 BERT Module (PPG) Default Settings

Item	Set Value
Signal Output	OFF
Error add	OFF
Error mode	Single
Clock source	Internal
Divide ratio	1/16
Logic	Positive
PPG IF	Electric
Data amplitude	1.00 [Vpp]
Data offset	0.00 [V]
Data cross point	50 [%]
Clock offset	0.00 [V]
Setup	Couple
Pattern	PRBS
PRBS length	PRBS7
Program length	16 [bit]
Program length (long)	256 [bit]
Program Pattern Data	All "55"
Payload	PRBS9
Trigger	TX1/16

### AQ2200-601 BERT Module (ED) Default Settings

Item	Set Value
Data threshold	DataIn 1
Input select	DataIn 1
Measure mode	Single
Measure day	0 [day]
Measure time	00 [h]:00 [m]:10 [s]
Buzzer	OFF
Auto sync	ON
Logic	Positive
Setup	Couple
Pattern	PRBS
PRBS length	PRBS7
Program length	16 [bit]
Program length (long)	256 [bit]
Program Pattern Data	All "55"
Payload	PRBS9
Trigger	TX1/16

**AQ2200-601 BERT Module (SG) Default Settings**

Item	Set Value
Bitrate	9.953280 [Gbit/s]
Offset	0 [ppm]

**AQ2200-601 BERT Module (BERT Appli) Default Settings**

Item	Set Value
Logging	OFF
Logging period	1 sec
Logging mode	Error only

**AQ2200-621 10Gbit/S Optical Modulator (1.55um) Default Settings**

Item	Set Value	Remarks
Driver Gain	180	For 1.5 $\mu\text{m}$ /X-cut
	160	For 1.5 $\mu\text{m}$ /Z-cut
Cross Point	0	
ABC Slope	Positive	
Auto Bias Ctrl	ON	
LN Bias set	0.00 [V]	

**AQ2200-622 10Gbit/S Optical Modulator (1.31um) Default Settings**

Item	Set Value	Remarks
Driver Gain	150	For 1.3 $\mu\text{m}$ /X-cut
	130	For 1.3 $\mu\text{m}$ /Z-cut
Cross Point	0	
ABC Slope	Positive	
Auto Bias Ctrl	ON	
LN Bias set	0.00 [V]	

**AQ2200-631 10 Gbit/s Optical Receiver Default Settings**

Item	Set Value
Data threshold	0
Data output	ON
Wavelength	1.5 [ $\mu\text{m}$ ]
Overload	-1.0 [dBm]
LOS	-16.0 [dBm]

## 13.8 Returning the Initial Settings

---

### AQ2200-641 XFP Interface Module Default Settings

Item	Set Value
Output	OFF
Password	00000000
Page Select	01
VCC2	1.800 V
VCC3	3.300 V
VCC5	5.000 V
VEE	-5.200 V
Unit	W

### AQ2200-642 Transceiver I/F Module Default Settings

Item	Set Value
Output	OFF
PS1	5.000 V
PS2	3.300 V
PS3	0.800 V
PS4	-5.20 V
PS5	3.3 V
AIN Threshold	0.50 V (AIN01 through AIN06)
PS Current Limit	1.00 A (PS1 through PS5)
I2C Clock Frequency	100 kHz
I2C Mode	CRC-8 OFF
MDIO Clock Frequency	625 kHz
Control signal names	CTRL01 to CTRL17 Not initialized when the frame or module settings are preset.
Control signal logic level	L (Ctrl01 through Ctrl17)
Monitor signal names	AIN01 to AIN06 Not initialized when the frame or module settings are preset.

### AQ2200-651 SG Module Default Settings

Item	Set Value
Output	OFF
Frequency	622.080000 MHz
Output Select	Disable (on all channels)
Offset	0 ppm
Amplitude	0.6 Vp-p
Rate	1/1
Reference	Internal

# Index

<b>A</b>	Page	<b>E</b>	Page
ABC Alarm.....	9-64	ED.....	1-23, 9-4
ABC Enabled.....	9-65	ERRCount.....	9-4
ABC ON/OFF.....	1-46	Error trigger.....	1-29, 1-32
ABC Slope.....	9-63	ERRRate.....	9-5
ABC Slope Change-over.....	1-47	Ethernet Communication.....	1-4
Analog Output.....	1-18, 3-28, 3-31	Event Trigger.....	3-22
APC.....	7-16	Event Trigger Position.....	3-20
Attenuating the Laser Output.....	4-19	Executes the Sweep.....	5-25
Attenuating the Optical Output.....	4-5, 4-29	external modulation option.....	1-8
attenuation.....	1-20		
attenuation offset.....	1-20	<b>G</b>	Page
Attenuation Offset Value.....	7-5	Gain of The Driver for the Optical Modulator.....	9-59
Auto Bias Control.....	1-46	GP-IB Address.....	13-2
auto power control.....	7-16	GP-IB Connector.....	1-3
Auto Range.....	1-17		
AUTO range.....	3-23	<b>H</b>	Page
Auto sync.....	1-36	Holding the Sensor Measurement Value Display.....	3-32
Average.....	1-14	HOLD range.....	3-23
Averaging Time.....	3-15, 7-14		
		<b>I</b>	Page
<b>B</b>	Page	Initial Settings.....	13-18
BERT Function.....	1-22	Inputting a Character String.....	2-9
Bias Manually.....	9-66	Interlock Connector.....	1-2
Bitrate.....	1-27, 9-7	Interrupt.....	1-51, 11-9
Bitrate Offset.....	1-27		
Bit Shift.....	1-39	<b>L</b>	Page
		Laser Line Width.....	4-13
<b>C</b>	Page	Laser Output.....	4-16, 4-25, 5-1
Calibrating the Output Wavelength.....	5-5	Light Source External Modulation Input.....	1-8
CDR.....	1-28	LINEAR mode.....	3-31
Changing the Wavelength.....	7-4	Line Width.....	5-11
CHOP.....	1-8	List of Default Settings.....	13-21
Clock offset.....	1-25	Lithium Niobate (LN).....	1-45
Clock trigger.....	1-29, 1-30	LN modulator.....	1-45
Coherence Control.....	1-7	Locking the Laser Output.....	13-4
Connection Port.....	8-1, 8-3	Lock Time per Wavelength.....	5-21
Connection with DUT.....	1-28	Log.....	12-6
Continuous Sweep.....	1-10, 5-29	LOG mode.....	3-31
cross cable.....	1-4	LOS point.....	1-50
Cross point.....	1-46	Loss Detection Level.....	9-75
Cross Point of the Driver for the Optical Modulator.....	9-61	lower table.....	11-10
Current module.....	2-2		
Current Optical Output Monitor Value.....	7-7	<b>M</b>	Page
CW.....	1-8	Manual Sweep.....	1-9, 5-25
		Maximum/Minimum Value.....	1-15
<b>D</b>	Page	Maximum Value.....	3-17
Data Amplitude.....	1-25	measurement data points.....	1-16
Data cross point.....	1-26	Measurement Mode.....	3-14
Data Logic.....	1-24	Measurement Range.....	3-23
Data Logic Inverting.....	1-24	Measurement Wavelength.....	3-12
Data offset.....	1-25	Minimum Value.....	3-17
Data output.....	9-73	Mod_NR(Module Not Ready).....	1-51
Data Points.....	1-16, 3-18	Modulating Laser Output (DFB-LD and FP-LD Modules).....	1-8
Data threshold.....	1-50	Modulating the Laser Output.....	4-10, 4-21
Data Threshold Value.....	9-71	Modulating the Optical Output.....	4-31
Display Resolution of Each Set Value.....	7-12	Modulation (CW/CHOP).....	1-17
display values.....	1-13	Modulation Frequency.....	4-11, 4-22, 4-32
Driver Gain.....	1-46	Modulation Mode (CW/CHOP).....	3-25
dual type.....	1-21, 8-3		
Dwell Time.....	5-21		

## Index

### **N** Page

Narrow .....	1-7
Network Address .....	13-3

### **O** Page

Offset .....	9-7
Offset of the Display Output Power .....	4-6, 4-20, 4-30
Optical Attenuation .....	7-3
Optical Modulator .....	1-44
Optical Output Level (DFB-LD Module).....	1-5
Optical Output Set Function .....	1-20
Optical Output Set Value .....	7-9
Optical Power Display Function.....	1-13
Optical Receiver .....	1-48
Optical Spectrum Analyzer .....	5-41
output line width.....	1-7
Output Power Level Value .....	5-12
Outputting the Laser Beam with the Set Power.....	4-18, 4-27
Outputting the Light at the Specified Power .....	4-4
Output Wavelength.....	5-7
Overload Detection Level .....	9-74
Overload Point.....	1-50

### **P** Page

password .....	13-6
Pattern trigger.....	1-29, 1-31
polarization dependent loss.....	1-15
Power Display Digits.....	3-11
power display unit.....	1-13
Power Display Unit. 3-3, 3-4, 4-14, 4-23, 4-33, 5-38, 7-13, 11-5	
Power Monitor .....	1-50
Power Offset Value .....	3-5, 7-11
Power Supply of the XFP Optical Transceiver.....	11-6
Power Threshold .....	3-21
Power (TLS Module).....	1-6
PPG.....	1-23, 9-3
PRBS Pattern .....	1-31
PRBS Pattern Synchronization.....	1-38
Program Pattern .....	1-31
Program Pattern Synchronization.....	1-39
Pseudo Random Pattern (PRBS Pattern) Generation.....	1-35

### **R** Page

Read-in Method .....	1-40
Reference Function .....	1-13
Reference Mode.....	3-6
Reference Value .....	3-8
Returning Various Parameters to Their Initial Values .....	2-8
Rx_LOS.....	1-51

### **S** Page

SDH/SONET Frame .....	1-41
SDH/SONET Frame Pattern.....	1-32
SDH/SONET Frame Synchronization.....	1-42
Setting $\Delta f$ .....	5-10
SG .....	1-23, 9-7
SG Unlock .....	9-7
single type .....	1-21, 8-1
Step Sweep .....	1-10, 5-27
storage device .....	12-5
straight cables .....	1-4
Sweep Cycles.....	5-18
Sweep Interval.....	5-19
Sweep Speed in the Continuous Sweep Mode .....	5-23

Sweep Start Wavelength .....	5-15
Sweep Step Wavelength .....	5-17
Sweep Stop Wavelength .....	5-16
Synchronous Sweep.....	5-41
Syncloss .....	9-4

### **T** Page

Threshold Level Variable Change .....	1-27
Trigger after Completion of the Sweep.....	5-35
Trigger after Starting of the Sweep.....	5-36
Trigger at Measurement Intervals.....	5-34
Trigger-in .....	1-3
Trigger Measurement .....	1-14
Trigger-out .....	1-3
Trigger Output .....	1-12
Trigger Sweep .....	1-11, 5-31
Turning ON/OFF the Optical Output.....	4-2

### **U** Page

upper table.....	11-10
USB Memory .....	1-3

### **V** Page

Value setting .....	3-7
---------------------	-----

### **W** Page

Warming Up.....	1-8
Wavelength Band of the Receiving Light Signal.....	9-76
Wavelength Correction Function .....	1-13
Wavelength (DFB-LD, FP-LD Module).....	1-7
Wavelength Display Unit .....	4-15, 4-24, 4-34, 5-39
Wavelength Offset .....	4-9
Wavelength (TLS Module).....	1-7

### **X** Page

XFP Interface Functions .....	1-51
XFP Transceiver-Internal Alarm Information.....	11-9
XFP Transceiver Output .....	11-3
x-y-z setting .....	3-7

### **Z** Page

ZERO-SET .....	1-17, 3-26, 7-8
----------------	-----------------