**User's
Manual**

**Model 701944/701945
100:1 Probe**

User Registration

YOKOGAWA provides registered users with useful information and services. Please allow us to serve you best by completing the user registration form accessible from our website.

<https://tmi.yokogawa.com/support/>



Contact Us

If you want to resolve a technical support issue or need to contact YOKOGAWA, please fill out the inquiry form on our website.

<https://tmi.yokogawa.com/contact/>



Thank you for purchasing the 701944 or 701945 100:1 probe. To ensure correct use, please read this manual thoroughly before beginning operation. After reading this manual, keep it in a convenient location for quick reference in the event a question arises during operation.

List of Manuals

The following manuals are provided for the 701944 and 701945 probe.

Manual Title	Manual Number	Description
Model 701944/701945 100:1 Probe User's Manual	IM 701944-01E	This manual. Explains usage, specifications, and the handling precautions of the 701944/701945.
Model 701944/701945 100:1 Probe	IM 701944-92	Document for China.
Safety Instruction Manual	IM 00C01C01-01Z1	Safety manual (European languages)

The "E" and "Z1" in the manual numbers are the language codes.

Contact information of Yokogawa offices worldwide is provided on the following sheet.

Document Number	Description
PIM 113-01Z2	List of worldwide contacts

Notes

- The contents of this manual are subject to change without prior notice as a result of improvements to the product's performance and functionality. Refer to our website to view our latest manuals.
- Every effort has been made in the preparation of this manual to ensure the accuracy of its contents. However, should you have any questions or find any errors, please contact your nearest YOKOGAWA dealer.
- Copying or reproducing all or any part of the contents of this manual without the permission of YOKOGAWA is strictly prohibited.

Trademarks

- Adobe and Acrobat are either registered trademarks or trademarks of Adobe Systems Incorporated.
- Other company and product names are trademarks or registered trademarks of their respective holders.
- In this manual, the ® and TM symbols do not accompany their respective registered trademark or trademark names.

Revisions

- 1st Edition November 2006
- 2nd Edition March 2007
- 3rd Edition March 2011
- 4th Edition March 2016
- 5th Edition October 2017
- 6th Edition June 2021
- 7th Edition May 2022
- 8th Edition May 2024

8th Edition: May 2024 (YMI)

All Rights Reserved, Copyright © 2006 Yokogawa Electric Corporation

All Rights Reserved, Copyright © 2011 Yokogawa Test & Measurement Corporation

Conventions Used in This Manual



Improper handling or use can lead to injury to the user or damage to the instrument. This symbol appears on the instrument to indicate that the user must refer to the user's manual for special instructions. The same symbol appears in the corresponding place in the user's manual to identify those instructions. In the manual, the symbol is used in conjunction with the word "WARNING" or "CAUTION."

WARNING

Describes precautions that should be observed to prevent serious injury or death to the user.

CAUTION

Describes precautions that should be observed to prevent minor or moderate injury, or damage to the instrument.

Note

Provides important information for the proper operation of the instrument.

Safety Precautions

This product is designed to be used by a person with specialized knowledge. To safely operate this product and to fully utilize its functionality, strictly observe the following cautions.

This product complies with the requirements stated in measurement categories II defined in IEC 61010-031.

If this probe is operated in a manner not specified in this manual, this may cause the protection capability of this product to lessen. YOKOGAWA shall not be held responsible for defects arising from negligence of such warning and caution, and also shall not guarantee the product in such case. Before using this probe, thoroughly read the instruction manual for measuring instrument to fully understand the specifications and handling precautions for safe and correct operation.



WARNING

- **Purpose of the product**
The product is used in combination with an oscilloscope to observe and measure electrical signals. Do not use for any other purpose.
- **Grounding of the measuring instrument**
The protective grounding terminal of the oscilloscope must be connected to ground.
- **Grounding of the probe**
Make sure to connect the ground lead of the probe to the grounding potential.
- **Be careful of electric shock**
Never use the probe with wet hands or when the probe itself is wet. Doing so may cause electric shock. Be careful of electric shock when you connect the probe to the device under measurement. Do not remove the probe from the oscilloscope while connected to the device under measurement.

-
- **Do not operate in wet or damp conditions**
To prevent electric shock, do not operate the probe in wet or damp conditions.
 - **Avoid exposed circuitry**
To prevent electric shock, remove metal and jewelry such as watches and rings. Do not touch exposed connections or components when power is present on the device.
 - **Do not operate in explosive atmosphere**
To prevent injury or fire hazard, do not operate the probe in an atmosphere of flammable or explosive gases or vapors.
 - **Do not operate with suspected failures**
Stop using the probe if you suspect that the probe is damaged. Consult your nearest YOKOGAWA dealer.
 - **Do not operate with a damaged signal cable**
If the signal cable is torn and the inner metal is exposed or if a color different from the outer sheath appears, stop using the cable.
 - **Do not disassemble or modify**
Do not disassemble or modify the product. YOKOGAWA assumes no liability if you disassemble or modify the product.
 - **Observe the maximum input voltage**
Do not apply a voltage exceeding the maximum input voltage to the probe. When the oscilloscope's input coupling is AC, a DC voltage is applied to the oscilloscope's input at the same electric potential as the probe's input. Make sure not to exceed the oscilloscope's maximum input voltage.
-

French



AVERTISSEMENT

- **But du produit**
Le produit est utilisé en association avec un oscilloscope pour observer et mesurer des signaux électriques. Ne l'utilisez pas à d'autres fins.
- **Mise à la terre de l'instrument de mesure**
La borne de terre de protection de l'oscilloscope doit être connectée à la terre.
- **Mise à la terre de la sonde**
Assurez-vous de connecter le fil de terre ou l'accessoire équivalent de la sonde au potentiel de mise à la terre.
- **Faites attention au choc électrique**
N'utilisez jamais la sonde les mains mouillées ou lorsque la sonde elle-même est mouillée. Cela pourrait provoquer un choc électrique. Faites attention au choc électrique lorsque vous connectez la sonde à l'appareil à mesurer. Ne retirez pas la sonde de l'oscilloscope lorsqu'il est connecté à l'appareil en cours de mesure.
- **N'opérez pas dans des conditions mouillées ou humides**
Pour éviter un choc électrique, ne faites pas fonctionner la sonde dans des conditions mouillées ou humides.

-
- **Évitez les circuits exposés**
Pour éviter un choc électrique, retirez le métal et les bijoux tels que les montres et les bagues. Ne touchez pas les connexions ou composants exposés en présence de courant sur l'appareil.
 - **N'opérez pas dans une atmosphère explosive**
Pour éviter les blessures et les risques d'incendie, n'utilisez pas la sonde dans une atmosphère de gaz ou des vapeurs inflammables ou explosifs.
 - **N'opérez pas en cas de défaillances suspectées**
Arrêtez d'utiliser la sonde si vous pensez qu'elle est endommagée. Consultez votre revendeur YOKOGAWA le plus proche.
 - **N'opérez pas avec le câble de signal endommagé**
Si le câble de signal est coupé et que le métal interne est exposé ou si une couleur différente de la gaine extérieure apparaît, arrêtez d'utiliser le câble.
 - **Ne démontez ou modifiez pas**
Ne démontez ou modifiez pas le produit. YOKOGAWA n'assume aucune responsabilité si vous démontez ou modifiez le produit.
 - **Respectez la tension d'entrée maximale**
N'appliquez pas une tension supérieure à la tension d'entrée maximale sur la sonde. Lorsque le couplage d'entrée de l'oscilloscope est AC, une tension DC est appliquée à l'entrée de l'oscilloscope au même potentiel électrique que l'entrée de la sonde. Assurez-vous de ne pas dépasser la tension d'entrée maximale de l'oscilloscope.
-

Regulations and Sales in Various Countries and Regions

Waste Electrical and Electronic Equipment (WEEE)



(EU WEEE Directive valid only in the EEA* and UK WEEE Regulation in the UK)

This product complies with the WEEE marking requirement. This marking indicates that you must not discard this electrical/electronic product in domestic household waste. When disposing of products in the EEA or UK, contact your local Yokogawa office in the EEA or UK respectively.

* EEA: European Economic Area

UKCA Marking



This product complies with the UKCA (UK Conformity Assessed) marking.

Authorized Representative in the EEA (AR)

Yokogawa Europe B.V. is the authorized representative of Yokogawa Test & Measurement Corporation for this product in the EEA. To contact Yokogawa Europe B.V., see the separate list of worldwide contacts, PIM 113-01Z2.

Disposal

When disposing of YOKOGAWA products, follow the laws and ordinances of the country or region where the product will be disposed of.

Overview

Model 701944 and 701945 are high voltage probes with attenuation ratio of 100:1. The very sharp probe tip is spring loaded and minimizes the pressure to the device under measurement. It also prevents the probe from slipping on the board surface. In particular, the spring mechanism is useful when using the probe with it inclined. In addition, various accessories are available.

Configuration

Standard and Optional Accessories

Standard Accessories

Probe unit (701944 or 701945)
Spring tip*
Rigid tip
Pincher tip
Insulation cap
Protection cap*
Ground lead
Color marker (4 colors x 3)
Adjustment tool
Manuals

* Attached to the probe unit

Optional Accessories

Flexible adapter
4mm plug ground lead
Safety alligator clip

Replaceable Parts Set

Two sets of replaceable parts are available.

Set name : Accessories Basic (Part number : B9852HK)

Packaged items	Quantity
Spring tip	2
Rigid tip	2
Pincher tip	2
Ground lead	2

Set name : Accessories HV (Part number : B9852HL)

Packaged items	Quantity
Flexible adapter	1
4mm plug ground lead	1
Safety alligator clip	2

Combinations of Accessories

CAUTION

- Use the ground lead only for grounding connections.
 - Do not use any accessories other than those specified.
-

French

ATTENTION

- Utilisez le fil de terre uniquement pour les connexions de mise à la terre.
 - N'utilisez pas d'accessoires autres que ceux spécifiés.
-

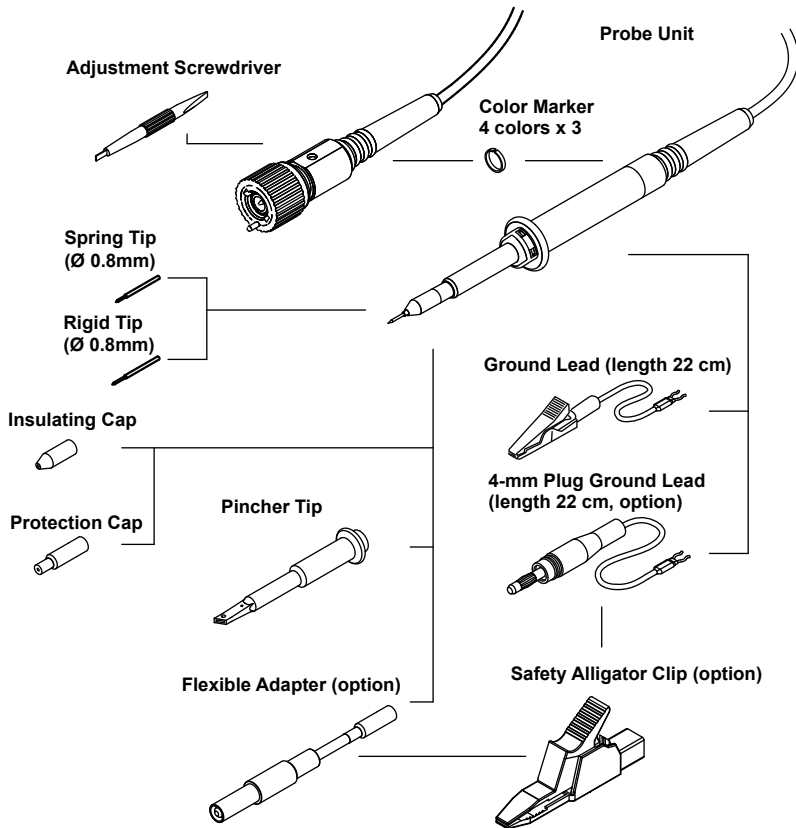

Usage

CAUTION

- Since the contact tips are very thin and sharp, handle them with care.
- Avoid shock to the probe body. Do not bend or pull the cables excessively. Doing so may damage or disconnect the probe.

French

ATTENTION

- Les pointes de contact étant très fines et pointues, manipulez-les avec précaution.
- Évitez les chocs sur le corps de la sonde. Ne pliez pas et ne tirez pas les câbles de manière excessive. Cela pourrait endommager ou déconnecter la sonde.

1. Connect the BNC connector of the probe to the input of an oscilloscope with the input impedance of 1 M Ω . Set the input impedance of the oscilloscope to 1 M Ω .
2. The probe ID pin is automatically detected, and the oscilloscope attenuation ratio is automatically set to 10:1. If it is not set automatically, set it manually.
3. Adjust the probe before use (see Adjustment Procedure for details).

Adjustment Procedures

CAUTION

Do not apply excessive force to the adjustment area. Doing so may break the internal parts.

French

ATTENTION

N'appliquez pas une force excessive sur la zone de réglage. Cela pourrait briser les pièces internes.

LF Compensation

When connecting the probe to an oscilloscope, perform an LF compensation before making measurements. LF compensation is used to match the probe capacitance to the oscilloscope input capacitance. LF compensation allows accurate measurements in the range from DC to the bandwidth's upper frequency limit.

Connect the probe input to the oscilloscope signal output terminal for probe compensation adjustment (CAL or COMP terminal). Adjust the LF compensation trimmer with the supplied adjustment screwdriver to make the observed waveform into a correct waveform (square wave).

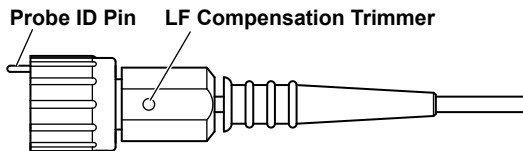

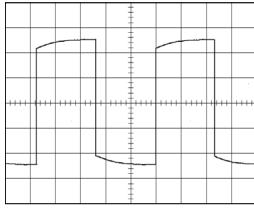

Under Compensated

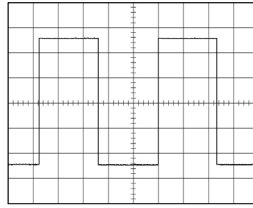

Correct Waveform

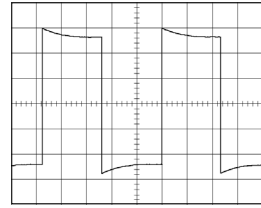

Over Compensated

HF Compensation

Adjustments are made at the factory before shipment.

If HF compensation is necessary, connect a signal generator capable of producing fast rise-time rectangular waves, and adjust the HF compensation trimmer with the supplied adjustment screwdriver to make the rising edge smooth. The HF compensation trimmer is located inside the outer cover.

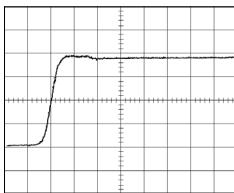
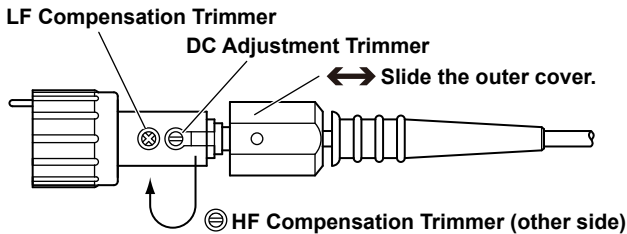

Optimum (typical)

DC Adjustment

To maintain higher accuracy, the DC gain is adjusted before shipment at the factory using a 500 VDC voltage source and a measuring instrument with an input impedance of $1\text{ M}\Omega \pm 0.01\%$.

Maintenance

Cleaning

When cleaning the exterior of the probe, clean it using a soft cloth rag moistened with either water or isopropyl alcohol. In this case, dry the probe completely before starting the measurement.

Changing the Contact Tip

To change the contact tip, grip the contact tip firmly with pliers and carefully pull it straight out of its contact socket along the axis of the probe. Do not grip the white plastic insulator or the housing with pliers, because this will damage the probe. If the contact tip is removed, the new contact tip can be inserted with pliers into the socket, along the axis of the probe. To insert the contact tip completely into the housing, press the contact tip against a hard surface carefully.

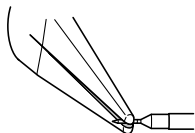

Use pliers to grip and pull the contact tip carefully out of its contact socket.

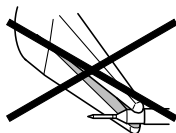

Do not grip the white plastic insulator or the housing with pliers.

Specifications

The specifications described in this section apply to the probe connected to Yokogawa's oscilloscope and may vary depending on the type of oscilloscope connected. The preconditions for the following specifications are that the instrument should be warmed up for at least 20 minutes and the environmental conditions should not exceed the specified limits of the probe.

Electrical Specifications

Item	701944	701945
Attenuation Ratio ¹	100:1 ±2% (DC)	100:1 ±2% (DC)
Voltage Coefficient	0.0005 %/V (typical value)	0.0005 %/V (typical value)
System Bandwidth ²	400 MHz (-3 dB)	250 MHz (-3 dB)
Probe Rise Time	< 900 ps (10% to 90%)	< 1.4ns (10% to 90%)
Maximum Input Voltage ³	1000 Vrms	1000 Vrms

1 This specification value is obtained when the probe is connected to an oscilloscope having an input resistance of $1\text{ M}\Omega \pm 1\%$.

2 This specification value is obtained when the probe is connected to an oscilloscope having a bandwidth of 500 MHz or greater.

When the probe is connected to an oscilloscope having a bandwidth of less than 500 MHz, depends on the bandwidth of the oscilloscope main unit.

3 See the compatible standards shown below. See also "Voltage Derating."

Electrical Characteristics

Input Resistance (system)	50 $\text{M}\Omega \pm 1\%$
Input Capacitance (system)	7.5 pF (typical value)
Input Impedance (system)	See also "Input Impedance."
Compensation Range	10 pF to 25 pF (typical value)
Input Coupling of the measuring instrument	1 $\text{M}\Omega$ DC/AC

Mechanical Characteristics

Weight (probe only)	Approx. 55 g
Cable Length	Approx. 1.2 m (701944), 3 m (701945)

External Dimensions

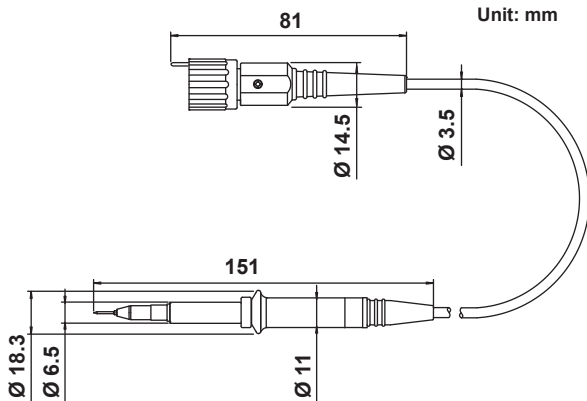

Environmental Specifications

Altitude	Operating:	Up to 2000 m
	Storage:	Up to 15000 m
Temperature	Operating:	0 °C to 50 °C
	Storage:	-40 °C to 71 °C
Maximum Relative Humidity	Operating:	Relative humidity of 80% at a temperature of up to 31 °C, decreasing linearly to relative humidity of 40% at 50 °C if the temperature is 31 °C or higher.

Compliant Standards

Safety Standards	EN 61010-031
	Measurement Category "O" ¹ 1000 Vrms, 4000 V transient over-voltage
	Measurement Category II ¹ 1000 Vrms
	Pollution Degree 2 ²
Environmental Standards ²	EU RoHS Directive compliant

- 1 The product is for measurement category II (CAT II). Do not use it with measurement category III (CAT III), nor measurement category IV (CAT IV). When using devices or accessories with different measurement categories, the lower measurement category applies. See below for definitions of measurement categories.
- 2 Pollution degree refers to the degree of adhesion of a solid, liquid, or gas which deteriorates withstand voltage or surface resistivity. Pollution Degree 2 applies to normal indoor atmospheres (usually with only non-conductive pollution).
- 3 For conformity to environmental regulations and/or standards other than EU, contact your nearest Yokogawa office (PIM 113-01Z2).

Definitions of Measurement Categories

Measurement Category "O" (Other)	It applies to measurement of a circuit that is not connected directly to the main power source.
Measurement Category II (CAT II)	It applies to measurement of electrical equipment that is powered through a fixed installation such as a wall outlet wired to a distribution board and measurement on such wiring.
Measurement Category III (CAT III)	It applies to measurement at the distribution level, that is, building wiring, fixed installations.
Measurement Category IV (CAT IV)	It applies to measurement at the primary supply level, that is, overhead lines, cable systems.

Voltage Derating

CAUTION

As the frequency of the input signal increases, the maximum input voltage of the probe decreases. See Specifications for the appropriate input voltage.

French

ATTENTION

Lorsque la fréquence du signal d'entrée augmente, la tension d'entrée maximale de la sonde diminue. Voir les spécifications pour la tension d'entrée appropriée.

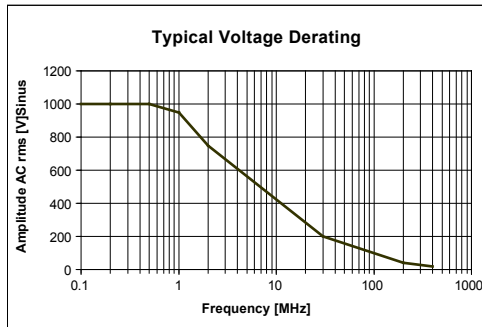

Input Impedance

CAUTION

As the frequency of the input signal increases, the input impedance of the probe decreases.

ATTENTION

Lorsque la fréquence du signal d'entrée augmente, l'impédance d'entrée de la sonde diminue.

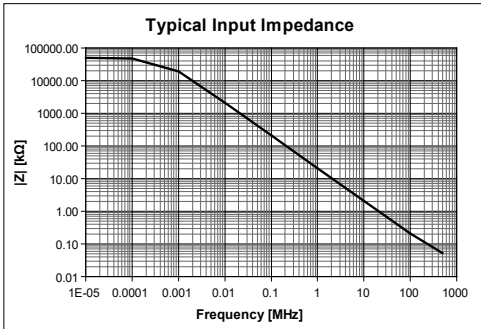

Maximum Pulse Ratings

For pulse measurements make sure to comply with the ratings as shown below.

