**User's
Manual**

**701917/701918
Current Probe**

User Registration

YOKOGAWA provides registered users with useful information and services. Please allow us to serve you best by completing the user registration form accessible from our website.

<https://tmi.yokogawa.com/support/>



Contact Us

If you want to resolve a technical support issue or need to contact YOKOGAWA, please fill out the inquiry form on our website.

<https://tmi.yokogawa.com/contact/>



Thank you for purchasing the 701917/701918 Current Probe.
This user's manual explains the features, operating procedures, and handling precautions of the 701917/701918 Current Probe. To ensure correct use, please read this manual thoroughly before beginning operation. After reading this manual, keep it in a safe place.

List of Manuals

The following manuals are provided for the 701917/701918.

| Manual Title | Manual Number | Description |
|-------------------------------------------------------|------------------------------------|-------------------------------------------------------------|
| 701917/701918 Current Probe User's Manual | IM 701917-01EN | This manual |
| 701917/701918 Current Probe Safety Instruction Manual | IM 701917-92Z1 IM 00C01C01-01Z1 | Document for China Safety manual (European languages) |

The "EN" and "Z1" in the manual numbers are the language codes.

Contact information of Yokogawa offices worldwide is provided on the following sheet.

| Document Number | Description |
|-----------------|----------------------------|
| PIM 113-01Z2 | List of worldwide contacts |

Notes

- The contents of this manual are subject to change without prior notice as a result of improvements to the product's performance and functionality. Refer to our website to view our latest manuals.
- Every effort has been made in the preparation of this manual to ensure the accuracy of its contents. However, should you have any questions or find any errors, please contact your nearest YOKOGAWA dealer.
- Copying or reproducing all or any part of the contents of this manual without the permission of YOKOGAWA is strictly prohibited.

Revisions

| | |
|---------------|-------------|
| November 2015 | 1st Edition |
| March 2017 | 2nd Edition |
| December 2017 | 3rd Edition |
| June 2021 | 4th Edition |
| December 2021 | 5th Edition |
| May 2023 | 6th Edition |

6th Edition: May 2023 (YMI)

All Rights Reserved, Copyright © 2015 YokogawaTest & Measurement Corporation

Checking the Contents of the Package

If the wrong items have been delivered, if items are missing, or if there is a problem with the appearance of the items, contact your nearest YOKOGAWA dealer.

| Item | Model/Part No. | Quantity | Notes |
|---------------|-----------------------|-----------------|--------------------|
| Hardware | 701917 or 701918 | 1 | Current probe |
| Carrying case | — | 1 | |
| Manual | IM 701917-01EN | 1 | This manual |
| | IM 701917-92Z1 | 1 | Document for China |
| | IM 00C01C01-01Z1 | 1 | Safety manual |
| | PIM 113-01Z2 | 1 | List of contacts |

Safety Precautions

This instrument is designed to be used by a person with specialized knowledge.

This instrument meets the requirements of IEC-61010.

The general safety precautions described herein must be observed during all phases of operation. If the instrument is used in a manner not specified in this manual, the protection provided by the instrument may be impaired. YOKOGAWA assumes no liability for the customer's failure to comply with these requirements. In addition, before using the probe, read the manuals of the measuring instrument to thoroughly familiarize yourself with its specifications and operation.

The following symbols are used on this instrument.



Warning: handle with care. Refer to the user's manual or service manual. This symbol appears on dangerous locations on the meter which require special instructions for proper handling or use. The same symbol appears in the corresponding place in the manual to identify those instructions.



This symbol indicates that the instrument cannot be used on electric circuits that may cause an electrical shock or electrical burn.

Notes about Usage



WARNING

- This instrument is a probe for measuring current. Use it only for measuring current.
- Do not clamp a bare conductor. Such act is dangerous because the core and shield case are not insulated.
- Be careful not to damage the insulation cover of the conductor.

Safety Precautions

- If the waveform measuring instrument has measurement terminals other than the terminal that the output terminal (BNC) of this instrument (BNC) is connected to, be careful of the following so that connecting other inputs to those terminals do not make the connected terminal of this instrument or the internal circuitry live and dangerous.
- Be sure to ground the measurement instrument.
- When connecting the probe to the object under measurement, be careful of electric shock. Do not remove the probe from the measurement instrument while the probe is connected to the object under measurement.
- Before connecting the probe to the object under measurement, check that the measuring instrument and the power supply are grounded properly and that the probe output connector and power plug are connected to the measuring instrument's BNC connector and power supply receptacle, respectively.
- Refer to the precautions (warnings) regarding electric shock and other safety matters of the measuring instruments to be connected, and use the devices carefully.
- Do not let the instrument get wet or operate it with wet hands. Doing so may cause electric shock.
- Do not block the vent holes on the side and bottom of the instrument's terminator. Doing so will cause the internal temperature to rise and may lead to fire or malfunction.
- If you want to connect this instrument to a measuring instrument on which isolation is not available between the input terminal and case or between the input terminal and other input terminals, note the following.

The instrument's reference potential is the grounding potential. Do not apply electric potential with different grounds to the other input terminals. Doing so will cause short circuit current to flow from the ground terminal through the 701934 or 700938 power supply or this instrument and may cause electric shock or damage to the devices.

- Do not short-circuit between the two measurement lines with the metal part of the sensor unit. It may lead to a serious accident such as the occurrence of an arc.
 - Use this instrument within the operating temperature and humidity ranges.
 - To prevent electric shock or fire or damage to this instrument, do not install in the following places.
 - In direct sunlight or hot location
 - In the presence of flammable gases or vapors Using this instrument in the following environment is extremely dangerous.
 - This instrument is not waterproof or dustproof. In a dusty environment or in an environment where the instrument is exposed to water, oil, chemicals, or solvents
 - In a strong magnetic field or near objects charged with static electricity
 - Near a high frequency dielectric heating device, IH cookware, or other dielectric heating equipment
 - In an environment subject to large levels of mechanical vibration
 - Near high frequency power equipment
-

French



AVERTISSEMENT

- Cet équipement est une sonde permettant de mesurer le courant. Utilisez cet équipement uniquement pour mesurer le courant.
- Ne serrez pas un conducteur nu. Une telle action est dangereuse, car le noyau et le casier de blindage ne sont pas isolés.
- Faites attention de ne pas endommager le cache d'isolation du conducteur.

Safety Precautions

- Si l'équipement de mesure de l'onde de forme est doté de bornes de mesure autres que la borne à laquelle la borne de sortie (BNC) de cet équipement (BNC) est reliée, soyez attentif à ce qui suit, de manière à ce que le fait de raccorder d'autres entrées à ces bornes n'active pas la borne raccordée de cet équipement ou les courts-circuits internes, ce qui pourrait être dangereux.
- Assurez-vous de relier à la terre l'équipement de mesure.
- Lorsque vous raccordez la sonde à l'objet à mesurer, soyez attentif au choc électrique. Ne retirez pas la sonde de l'équipement de mesure si elle est raccordées à l'objet à mesurer.
- Avant de raccorder la sonde à l'objet à mesurer, vérifiez que l'équipement de mesure et l'alimentation électrique sont correctement reliés à la terre et que le connecteur de sortie de la sonde et la fiche secteur sont respectivement raccordés au connecteur BNC de l'équipement de mesure et à la prise secteur.
- Reportez-vous aux mises en garde (avertissements) concernant le choc électrique et d'autres points de sécurité des appareils à raccorder et utilisez les appareils avec précaution.
- Évitez que l'équipement ne soit mouillé et ne le manipulez pas avec des mains humides. Ceci risquerait d'entraîner un choc électrique.
- N'obstruez pas les orifices de ventilation situés sur le côté et en bas du terminateur de l'équipement. Cela risquerait sinon de faire augmenter la température interne et d'entraîner un incendie ou un dysfonctionnement.
- Si vous souhaitez raccorder cet équipement à un équipement de mesure sur lequel il n'y a pas d'isolation entre la borne d'entrée et le casier ou entre la borne d'entrée et les autres bornes d'entrée, veuillez noter ce qui suit.
Le potentiel de référence de l'équipement est le potentiel de mise à la terre. N'appliquez pas de potentiel électrique avec différentes terres à d'autres bornes d'entrée. Cela risquerait d'entraîner la circulation d'un courant de court circuit sortant de la borne de terre à travers l'alimentation électrique 701934 ou 700938 ou à travers cet équipement et cela risquerait d'entraîner un choc électrique ou d'endommager les appareils.

- Ne pas court-circuiter entre les deux lignes de mesure avec la partie métallique du capteur. Cela peut entraîner un accident grave tel que l'apparition d'un arc.
 - Utilisez cet équipement dans les plages de température de fonctionnement et d'humidité.
 - Pour éviter tout choc électrique ou tout incendie ou encore éviter d'endommager cet équipement, ne l'installez pas dans les endroits suivants.
 - Exposé aux rayons directs du soleil ou dans un endroit chaud
 - Au contact de gaz ou de vapeurs inflammables. Il est extrêmement dangereux d'utiliser cet équipement dans l'environnement suivant.
 - Cet équipement n'est pas étanche à l'eau ou à la poussière. Dans un environnement poussiéreux ou dans lequel l'équipement est au contact de l'eau, d'huile, de produits chimiques ou de solvants
 - Dans un champ magnétique puissant ou à proximité d'objets chargés d'électricité statique
 - À proximité d'un radiateur diélectrique à haute fréquence, d'articles culinaires IH ou d'un équipement de chauffage diélectrique
 - Dans un environnement soumis à des niveaux élevés de vibrations mécaniques
 - À proximité d'un équipement électrique à haute fréquence"
-
-



CAUTION

- Avoid vibration and shock during shipping and handling. Take extra care not to drop the probe.
- Avoid storing or using the probe in direct sunlight or in areas with high temperature, humidity, or condensation. Deformation and insulation deterioration can occur causing the probe to no longer meet the specifications.

Safety Precautions

- Before use, inspect and check the operation of the probe to verify that it has not been damaged as a result of storage, transportation, and other conditions. If damage is detected, contact your nearest YOKOGAWA dealer.
- The sensor head is an intricately assembled component made of a molded part, ferrite core, Hall effect element, and so on. It can be damaged due to drastic changes in ambient temperature, mechanical stress, or shock. Handle it with care.
- The facing surfaces of the sensor head are precisely ground. Handle with care because if the surfaces are scratched, the performance will be affected.
- If dirt or the like adheres to the facing surfaces of the sensor head, wipe them with a soft cloth or the like. Dirty surfaces may affect the performance.
- To prevent broken cables, do not pull on the sensor cables or power cables.
- Static electricity can damage the current sensor. Be careful not to apply static electricity to current sensors. Below are some examples.
 - Do not touch the sensor head with an object charged with static electricity.
 - Do not touch the sensor head with an object whose electric potential is different.
 - Do not touch the core surface with static electricity charged body parts when cleaning the facing surfaces of the sensor head.
(When cleaning the surfaces, take static electricity measures such as wearing an antistatic wrist strap.)
- To wipe off dirt from the instrument, apply a small amount of water or neutral agent to a soft cloth and wipe gently. Never use agents containing benzene, alcohol, acetone, ether, ketone, thinner, or gasoline. Doing so may deform or discolor the instrument.
- Do not apply strong shock or force to the terminator when the probe is connected to the measuring instrument. Doing so may damage the probe or the measuring instrument.

- Do not place the instrument on an unstable or sloped surface. The instrument may fall or roll and cause injury or damage to the instrument.
- Do not turn the terminator of this instrument when it is connected to the waveform measuring instrument. Doing so can damage the terminator or the input terminal of the waveform measuring instrument.
- Do not allow current to flow through the instrument when the connected waveform measuring instrument is turned off. Doing so can damage the instrument or the waveform measuring instrument.
- When connecting or disconnecting this instrument from the waveform measuring instrument, align the terminator straight with the waveform measuring instrument's terminal to prevent damaging the terminator.
- To prevent damaging this instrument's output terminal when you remove this instrument from the waveform measuring instrument, pull the lock release lever completely toward you, and then remove it.
- Do not bring conductors running 10 kHz or higher current near the instrument's sensor head. The sensor head temperature may increase due to self-heating from the current running through the conductor and may be damaged. As shown in the figure below, if one of bidirectional conductors is clamped and the other conductor is near the sensor head, the self-heating induced by the bidirectional current, even if the current is less than the maximum rated current, will cause a large temperature increase. Be careful as this may damage the sensor head.

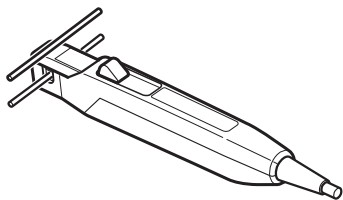

Safety Precautions

- Even when the current is less than the maximum rated current, self-heating may damage the instrument. The maximum rated current is a recommended value when a sine signal is applied under standard conditions. Self-heating increases if the ambient temperature increases or if the measured current waveform contains other frequency components. See the derating characteristics in the product specifications.
 - In addition to the maximum rated current, the product specifications that indicate the maximum input range include “maximum peak current of ± 7.5 A peak (discontinuous),” which is an absolute upper limit that cannot be exceeded even for an instant. To prevent damaging the instrument, do not measure current that exceeds the maximum peak current.
 - The overload warning detection frequency range is DC and 45 to 66 Hz (sine wave). The overload warning may not work when current outside the detection frequency range is measured. Regardless of whether the OVERLOAD LED is blinking, be careful not to exceed the maximum rated current.
 - Lock the jaws except when clamping to the conductor to be measured and when removing it from the conductor. Leaving it open can damage the product.
 - If the resonant sound increases during use, the spacing between the upper and lower sensors may have widened. The sensor characteristics may change, so we recommend calibrating the sensor.
 - To prevent vent holes from clogging, clean them regularly. Clogged vent holes will reduce the cooling effect inside the instrument and may cause it to break.
-

French

**ATTENTION**

- Évitez les vibrations et les chocs au cours de l'expédition et de la manipulation. Faites particulièrement attention à ne pas faire tomber la sonde.
- Évitez de stocker ou d'utiliser la sonde en l'exposant aux rayons directs du soleil ou dans des zones à haute température, forte humidité ou forte condensation. Une déformation et une détérioration de l'isolation peuvent se produire et avoir pour conséquences que la sonde ne soit plus conforme aux spécifications.
- Avant l'utilisation, inspectez et contrôlez le fonctionnement de la sonde afin de vérifier qu'elle n'a pas été endommagée à cause du stockage, du transport et d'autres opérations. Si un endommagement est détecté, contactez votre distributeur YOKOGAWA le plus proche.
- La tête du capteur est un composant assemblé de manière complexe et composé d'une pièce moulée, d'un noyau de ferrite, d'un élément d'effet Hall etc. Ce composant risque de s'endommager suite à des changements brusques de température ambiante, à une contrainte mécanique ou un choc. Manipulez-le avec soin.
- Les faces de la tête du capteur sont mises à la terre avec précision. Manipulez-les avec soin, car si elles sont rayées, leurs performances seront altérées.
- Si de la poussière ou autre vient se coller sur les faces de la tête du capteur, essuyez-les avec un chiffon doux ou quelque chose de similaire. Des surfaces poussiéreuses peuvent altérer les performances.
- Afin d'empêcher les câbles de casser, ne tirez pas sur les câbles du capteur ou d'alimentation.

Safety Precautions

- L'électricité statique risque d'endommager le capteur de courant. Faites attention de ne pas appliquer d'électricité statique sur les capteurs de courant. Voici ci-dessous quelques exemples.
 - Ne touchez pas la tête du capteur avec un objet chargé d'électricité statique.
 - Ne touchez pas la tête du capteur avec un objet au potentiel électrique différent.
 - Ne touchez pas la surface du noyau avec des parties du corps chargées d'électricité statique lorsque vous nettoyez les faces de la tête du capteur.
(Lorsque vous nettoyez les surfaces, prenez des mesures anti-électricité statique telles que le port d'un bracelet antistatique.)
- Pour dépeussier au chiffon l'équipement, appliquez une petite quantité d'eau ou d'agent neutre sur un chiffon doux et essuyez soigneusement. N'utilisez jamais d'agent contenant du benzène, de l'alcool, de l'acétone, de l'éther, de la cétone, du diluant ou de l'essence. Cette action risque de déformer ou de décolorer l'équipement.
- N'appliquez pas de choc puissant ou n'exercez pas de force sur le terminateur lorsque la sonde est raccordée à l'équipement de mesure. Cela pourrait endommager la sonde ou l'équipement de mesure.
- Ne placez pas l'équipement sur une surface instable ou inclinée. L'équipement risquerait de tomber ou de rouler et d'entraîner des blessures ou encore de s'endommager.
- Ne faites pas pivoter le terminateur de cet équipement lorsqu'il est raccordé à l'équipement de mesure de la forme d'onde. Ceci risquerait d'endommager le terminateur ou la borne d'entrée de l'équipement de mesure de la forme d'onde.
- Ne laissez pas le courant circuler à travers l'équipement lorsque l'équipement de mesure de la forme d'onde raccordé est éteint. Cela pourrait endommager l'équipement ou l'équipement de mesure de la forme d'onde.
- Lors du branchement ou du débranchement de cet équipement de l'équipement de mesure de la forme d'onde, alignez le terminateur avec celui de l'équipement de mesure de la forme d'onde afin d'éviter d'endommager le terminateur.

- Afin d'éviter d'endommager la borne de sortie de cet équipement lorsque vous retirez cet équipement de l'équipement de mesure de la forme d'onde, tirez complètement vers vous le levier de déverrouillage, puis retirez-le.
- N'appliquez pas un courant de 10 kHz ou plus sur les conducteurs à proximité de la tête de capteur de l'équipement. La température de la tête du capteur risque d'augmenter suite à une surchauffe automatique due au courant circulant à travers le conducteur, ce qui risque d'entraîner un endommagement. Comme l'indique la figure ci-dessous, si l'un des conducteurs bidirectionnels est serré et que l'autre conducteur se trouve à proximité de la tête du capteur, la surchauffe automatique due au courant bidirectionnel, même si l'intensité est inférieure à l'intensité nominale maximale, risque d'entraîner une importante augmentation de la température. Opérez avec précaution, ceci risque d'endommager la tête du capteur.

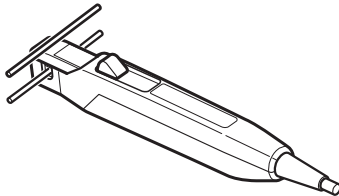

- Même si l'intensité du courant est inférieure à l'intensité nominale maximale, la surchauffe automatique risque d'endommager l'équipement. L'intensité nominale maximale est une valeur conseillée lorsqu'un signal sinusoïdal est appliqué dans les conditions standards. La surchauffe automatique augmente si la température ambiante augmente ou si la forme d'onde d'intensité mesurée contient d'autres composants de fréquence. Reportez-vous aux caractéristiques de déclassement figurant dans les spécifications du produit.

Safety Precautions

- En plus de l'intensité nominale maximale, les spécifications du produit indiquant la plage d'entrée maximale comprennent le « pic d'intensité maximale de $\pm 7,5$ A (en discontinu) », qui correspond à une limite supérieure absolue qui ne peut être dépassée même un instant. Afin d'éviter que l'équipement ne s'endommage, ne mesurez pas l'intensité qui dépasse l'intensité de pic maximale.
 - La plage de fréquence de détection d'avertissement en cas de surcharge correspond à un courant continu et est comprise entre 45 et 66 Hz (onde sinusoïdale). L'avertissement en cas de surcharge risque de ne pas fonctionner lors de la mesure du courant en dehors de la plage de fréquence de détection. Que la LED de SURCHARGE clignote ou non, faites attention de ne pas dépasser le courant nominal maximal.
 - Verrouiller les mâchoires sauf lors du serrage sur le conducteur à mesurer et lors de son retrait du conducteur. Le laisser ouvert peut endommager le produit.
 - Si le son résonnant augmente pendant l'utilisation, l'espacement entre les capteurs supérieur et inférieur peut s'être élargi. Les caractéristiques du capteur peuvent changer, donc nous vous conseillons de calibrer le capteur.
 - Afin d'éviter d'obstruer les orifices de ventilation, nettoyez-les régulièrement. Les orifices de ventilation obstrués réduisent l'effet de refroidissement à l'intérieur de l'équipement et risquent de le casser.
-

Note

- Accurate measurements may not be possible near objects with strong electromagnetic fields such as transformers, large current circuits, and wireless equipment.
 - Depending on the current frequency that is measured, oscillation may occur, but this has no effect on measurements.
-

Regulations and Sales in Various Countries and Regions

Waste Electrical and Electronic Equipment (WEEE)



(EU WEEE Directive valid only in the EEA* and UK WEEE Regulation in the UK)

This product complies with the WEEE marking requirement. This marking indicates that you must not discard this electrical/electronic product in domestic household waste. When disposing of products in the EEA or UK, contact your local Yokogawa office in the EEA or UK respectively.

* EEA: European Economic Area

Authorized Representative in the EEA (AR)

Yokogawa Europe B. V. is the authorized representative of Yokogawa Test & Measurement Corporation for this product in the EEA. To contact Yokogawa Europe B. V., see the separate list of worldwide contacts, PIM 113-01Z2.

Disposal

When disposing of YOKOGAWA products, follow the laws and ordinances of the country or region where the product will be disposed of.

Conventions Used in This Manual



Improper handling or use can lead to injury to the user or damage to the instrument. This symbol appears on the instrument to indicate that the user must refer to the user's manual for special instructions. The same symbol appears in the corresponding place in the user's manual to identify those instructions. In the user's manual, the symbol is used in conjunction with the word "WARNING" or "CAUTION."

WARNING

Calls attention to actions or conditions that could cause serious or fatal injury to the user, and precautions that can be taken to prevent such occurrences.

CAUTION

Calls attention to actions or conditions that could cause light injury to the user or damage to the instrument or user's data, and precautions that can be taken to prevent such occurrences.

Note

Calls attention to information that is important for the proper operation of the instrument.

French

AVERTISSEMENT

Attire l'attention sur des gestes ou des conditions susceptibles de provoquer des blessures graves (voire mortelles), et sur les précautions de sécurité pouvant prévenir de tels accidents.

ATTENTION

Attire l'attention sur des gestes ou des conditions susceptibles de provoquer des blessures légères ou d'endommager l'instrument ou les données de l'utilisateur, et sur les précautions de sécurité susceptibles de prévenir de tels accidents.

Contents

| | |
|--------------------------------------------------------------|----|
| List of Manuals..... | 1 |
| Checking the Contents of the Package | 2 |
| Safety Precautions | 3 |
| The following symbols are used on this instrument | 3 |
| Notes about Usage | 3 |
| Regulations and Sales in Various Countries and Regions | 15 |
| Conventions Used in This Manual..... | 16 |
| Product Overview..... | 18 |
| Component Names and Functions..... | 19 |
| Operation..... | 22 |
| Handling Precautions..... | 22 |
| Measurement Preparation | 22 |
| Demagnetization and Zero Adjustment..... | 25 |
| Measurement Method | 28 |
| Ending Measurement..... | 34 |
| Specifications..... | 36 |
| Product Specifications | 36 |
| Compliant Standards | 37 |
| External Dimensions..... | 37 |
| Characteristics | 38 |
| Functions | 43 |
| Troubleshooting | 45 |
| Before Sending the Instrument for Repair | 45 |
| Errors | 46 |

Product Overview

The 701917/701918 probes can be connected directly to the BNC input terminal of a YOKOGAWA DL/DLM series waveform measuring instrument or the like to easily measure current waveforms simply by clamping the target conductor.

Features

- Minute current (1 mA) waveform observation
- Slim and lightweight sensor head
- Automatic zero adjustment and demagnetization
- Wide frequency range DC to 50 MHz (701917)
DC to 120 MHz (701918)

Component Names and Functions

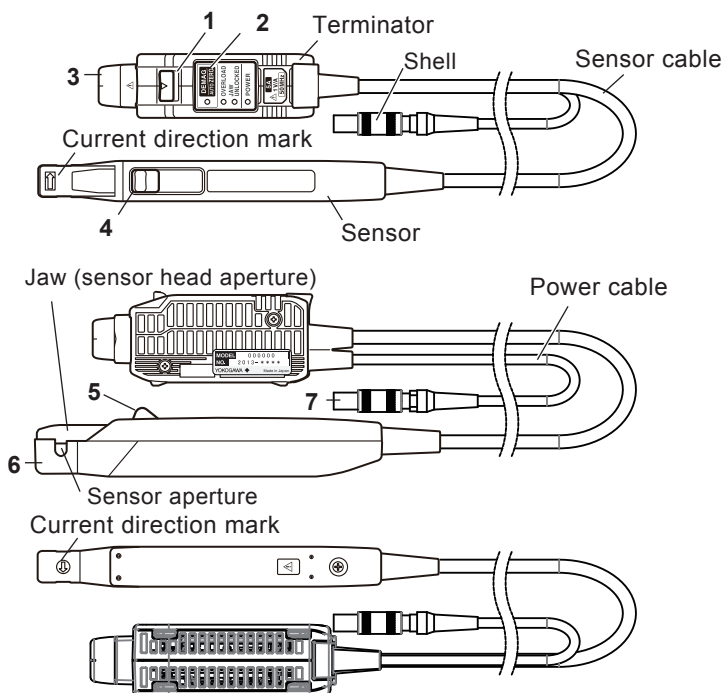

1 Lock release lever

This lever is for releasing the output terminal lock. To remove the output terminal, be sure to release the lock with this lever first.

2 DEMAG/AUTO ZERO switch

This can be used to eliminate the magnetic charge of the magnetic core that occurs from turning the power on and off, excessive input, and so on. This must be performed before measurement.

The auto-zero function corrects the unwanted effects caused by the instrument's inherent offset voltage, temperature drift, and the like. When making a measurement, press this switch. It will automatically perform zero adjustment along with demagnetization.

3 Output terminal

This terminal outputs measured current waveforms at a certain rate (according to the 1 V/A).

Connect it to the BNC input terminal of a waveform measuring instrument.

4 JAW UNLOCKED indication

This indicator, when shown, means that the sensor head is not locked.

5 Opening lever

This lever is for opening and closing the sensor head. Be sure to use this lever for opening and closing the sensor head.

6 Sensor head

This section clamps the conductor and detects current. It is an intricately assembled component made of a molded part, ferrite core, Hall effect element, and so on. It needs to be handled with care as it can be damaged from drastic ambient temperature changes, mechanical stress or shock, and so on.

7 Power plug

This plug is connected to a waveform measuring instrument with a probe power supply or to the power supply receptacle of a 701934 or 700938 power supply in order to supply power to the sensor and terminator.

Note

- The instrument's output is internally terminated. Use with a high input impedance waveform measuring instrument. Correct measurement is not possible with 50 Ω input impedance.
 - When connecting the probe to a non-BNC input terminal through a BNC-to-banana adapter or the like, pay attention to the polarity of the input terminal.
-

LED

DEMAG/AUTO ZERO switch (See page 10.)

DEMAG/AUTO ZERO LED

Slow blinking orange: Before demagnetization and zero adjustment, after an overload is detected
When demagnetization did not complete normally
Solid orange: Demagnetization and zero adjustment in progress
Off: Demagnetization and zero adjustment completed

OVERLOAD LED

Slow blinking red: Maximum rated current is about to be reached. Be careful not to exceed the maximum rated current.
Fast blinking red: Maximum rated current exceeded. Remove the sensor from the conductor immediately.

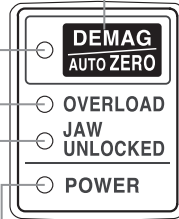

POWER LED

Solid green: Powered

JAW UNLOCKED LED

Solid red: Sensor head not locked

Operation

Handling Precautions



WARNING

- Do not clamp a bare conductor. Such act is dangerous because the core and shield case are not insulated.
- Be careful not to damage the insulation cover of the conductor.
- Do not short-circuit between the two measurement lines with the metal part of the sensor unit. It may lead to a serious accident such as the occurrence of an arc.

French



AVERTISSEMENT

- Ne serrez pas un conducteur nu. Une telle action est dangereuse, car le noyau et le casier de blindage ne sont pas isolés.
- Faites attention de ne pas endommager le cache d'isolation du conducteur.
- Ne pas court-circuiter entre les deux lignes de mesure avec la partie métallique du capteur. Cela peut entraîner un accident grave tel que l'apparition d'un arc.

Measurement Preparation



CAUTION

- When connecting the probe to a waveform measuring instrument, attach and detach it straight to the BNC terminal of the waveform measuring instrument so that the termination part of the probe is not damaged.

- When using a 701917/701918 current probe, it may not be possible to use multiple active probes at the same time with the 701934, 700938 power supply, or the probe power supply from a YOKOGAWA waveform measuring instrument. Make sure that the total current consumption of each active probe does not exceed the current specifications of the probe power supply. The current consumption of the probe depends on the measured current (refer to the figure below).

See the YOKOGAWA website for the usage limitations for each measuring instrument.

<https://tmi.yokogawa.com/solutions/products/oscilloscopes/current-probes/>
 Current Probes > Details > Current Consumption

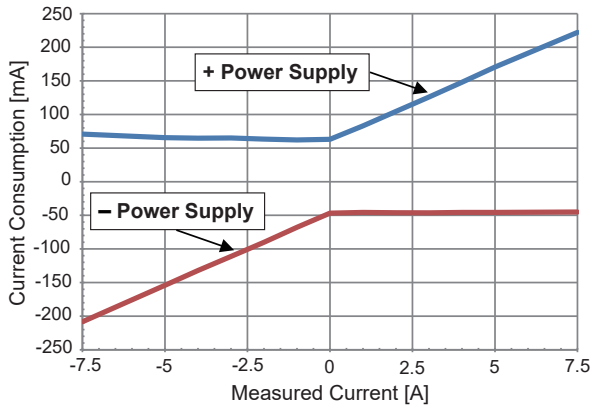

Measured Current and Current Consumption of 701917/701918 (Typical)

French



ATTENTION

- Lors de la connexion de la sonde à un instrument de mesure de forme d'onde, fixez-la et détachez-la directement à la borne BNC de l'instrument de mesure de forme d'onde afin que la partie terminale de la sonde ne soit pas endommagée.

- En cas d'utilisation d'une sonde de courant 701917/701918, il peut ne pas être possible d'utiliser plusieurs sondes actives en même temps avec l'alimentation 701934 ou 700938, ou l'alimentation de la sonde d'un instrument de mesure de la forme d'onde YOKOGAWA. S'assurer que la consommation totale de chaque sonde active ne dépasse pas les caractéristiques de courant de l'alimentation de la sonde. La consommation de courant de la sonde dépend du courant mesuré (voir la figure ci-dessous).

Consultez le site Web de YOKOGAWA pour les limites d'utilisation de chaque instrument de mesure.

<https://tmi.yokogawa.com/solutions/products/oscilloscopes/current-probes/Current Probes > Details > Current Consumption>

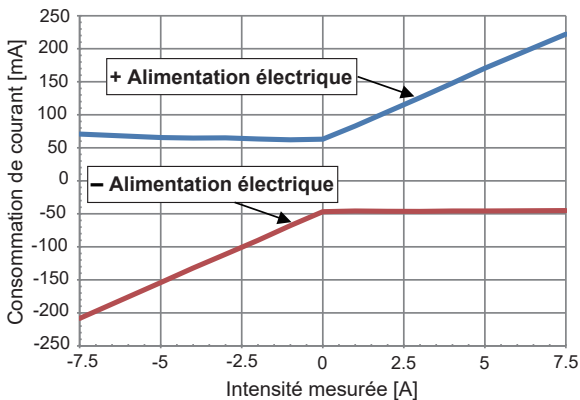

Intensité mesurée et consommation de courant de 701917/701918 (typique)

Prepare this instrument and a waveform measuring instrument such as a digital oscilloscope or recorder. If the waveform measuring instrument is not equipped with a probe power supply (option), prepare also a 701934 or 700938 power supply.

1. If you are using a YOKOGAWA waveform measuring instrument with a probe power supply, turn the waveform measuring instrument off.
If you are using the 701934 or 700938, turn it off.
2. Hold down the instrument's opening lever until the JAW UNLOCKED indication disappears to lock the sensor head. Do not clamp the conductor at this point.
3. Connect this instrument's power cable to a YOKOGAWA waveform measuring instrument with a probe power supply or to the power supply receptacle of a 701934/700938 power supply. Firmly connect so that the power cable shell locks in place.
4. Turn on the waveform measuring instrument with a probe power supply or the 701934/700938 power supply. The instrument's power lamp (POWER) illuminates, and the DEMAG/AUTO ZERO LED blinks slowly while demagnetization and zero adjustment are taking place.

Note

The offset drift may be large immediately after starting to supply power due to instrument's self-heating and other effects. To make accurate measurements, warm up for at least 30 minutes.

Demagnetization and Zero Adjustment



WARNING

While a conductor is clamped, do not hold down the DEMAG/AUTO ZERO switch to demagnetize. Doing so can damage the circuit under measurement or cause electric shock or burns.

French



AVERTISSEMENT

Si un conducteur est serré, ne maintenez pas enfoncé l'interrupteur DEMAG/AUTO ZERO (Démagnétisation/remise à zéro automatique) pour la démagnétisation. Cette action risquerait d'endommager le circuit à mesurer ou d'entraîner un choc électrique ou une combustion.



CAUTION

- Do not demagnetize with a conductor clamped. The current that flows through the conductor as a result of demagnetization may damage components of the circuit under measurement. For the same reason, make sure that the conductor is not clamped when supplying power to the 701917/701918. A demagnetization waveform may be generated when power is supplied.
 - When you press the demagnetization switch, hold the terminator in your hand to prevent excessive force from being applied to the connector. Applying excessive force to the connector may damage the instrument or the measuring instrument.
-

French



ATTENTION

- N'effectuez pas de démagnétisation avec un conducteur serré. Le courant qui circule à travers le conducteur suite à une démagnétisation risque d'endommager les composants du circuit à mesurer. Pour la même raison, assurez-vous que le conducteur n'est pas serré lors de l'alimentation en courant de 701917/701918. Une forme d'onde de démagnétisation peut être générée lors d'une alimentation en courant.
-

- Lorsque vous appuyez sur l'interrupteur de démagnétisation, conservez le terminateur dans votre main afin d'éviter qu'une force trop importante ne soit exercée sur le connecteur. Le fait d'exercer une force trop importante sur le connecteur risque d'endommager l'équipement ou l'équipement de mesure.
-

Be sure to perform demagnetization and zero adjustment before making measurements. Demagnetization and zero adjustment take about 20 seconds to complete.

Demagnetization is used to eliminate the magnetic charge of the magnetic core that occurs from turning the power on and off, excessive input, and so on.

Zero adjustment is used to correct the instrument's inherent offset voltage and offset voltage variation caused by temperature changes or the like.

- 1.* Set the input coupling of the waveform measuring instrument to GND, and adjust the zero position on the display.
- 2.* Set the input coupling of the waveform measuring instrument to DC.
- 3.* Connect this instrument's output terminal to the BNC input terminal of the waveform measuring instrument. Insert it straight until it clicks in place to securely lock it.

Connection is possible regardless of whether the lock pin of the waveform measuring instrument's BNC input terminal is arranged horizontally or vertically.

- 4.* Hold down **DEMAG/AUTO ZERO** for about 1 second. Be careful not to press too hard.

Demagnetization is performed followed by zero adjustment.

While demagnetization and zero adjustment are taking place, the DEMAG/AUTO ZERO LED is lit.

When demagnetization and zero adjustment is complete, the LED turns off.

Operation

If the DEMAG/AUTO ZERO LED does not turn off but blinks even if you press the DEMAG/AUTO ZERO switch, this indicates that demagnetization and zero adjustment have not been completed normally. See “Demagnetization and zero adjustment do not been completed normally” (p. 45).

Note

- The instrument’s output is internally terminated. Use with a high input impedance waveform measuring instrument. Correct measurement is not possible with 50 Ω input impedance.
 - Resonant sound may occur when you perform demagnetization, but this has no effect on measurements.
 - After starting to supply power or after a condition in which the rating is exceeded is removed, the DEMAG/AUTO ZERO LED blinks slowly until demagnetization and zero adjustment are executed.
 - While demagnetization is taking place (the DEMAG/AUTO ZERO LED is on), a demagnetization waveform (waveform that attenuates over time) is output from this instrument’s output terminal and appears on the waveform measuring instrument. The positive and negative sides of this waveform may be asymmetric, but this is not a malfunction.
 - To abort demagnetization and zero adjustment, release the sensor head lock. Then, execute demagnetization and zero adjustment again according to the procedure.
-

To Perform Only Zero Adjustment

To perform only zero adjustment (without demagnetization), press **DEMAG/AUTO ZERO** for a short time in step 4 on the previous page. The DEMAG/AUTO ZERO LED turns on. When zero adjustment is complete, the LED turns off.

Measurement Method



CAUTION

- The continuous maximum input range is a value defined based on the temperature increase due to self-heating during measurement. Do not apply current outside this range. Doing so can damage the instrument.
-

- The continuous maximum input range varies depending on the frequency of the measured current. See the product specifications (p. 36).
- If current exceeding the continuous maximum input range is applied, the internal protection function will be activated as a result of the heat generated by the sensor, and the probe will not output correct values. If this happens, immediately remove the input (remove the sensor head from the conductor or reduce the input current to zero). Adequate cooling period will be required until the probe can output correct values again.
- In a high temperature environment, the internal overcurrent protection circuit may be activated even at currents within the continuous maximum input range.
- If current exceeding the continuous maximum input range is applied continuously or if the protection function is activated frequently, the instrument may break.
- In addition to the continuous maximum input range, the product specifications that indicate maximum input range include “discontinuous maximum peak current of 7.5 Apeak.” This signifies that the upper limit of waveform response is 7.5 Apeak. Use the probe in a way that the rms value does not exceed the continuous maximum input range.
- Be sure to use the opening lever to open the sensor head. Pressing the top core when the sensor head is locked will damage the clamping mechanism.
- Do not apply force to the sensor head in the direction shown in the following figure.

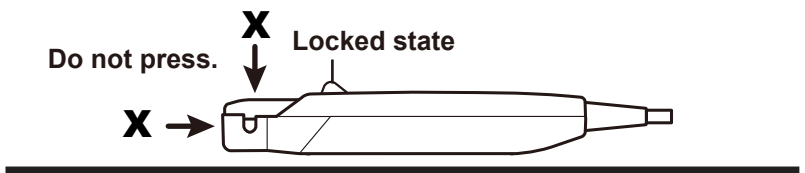

French



ATTENTION

- La plage d'entrée continue maximale est une valeur définie en fonction de l'augmentation de température due à la surchauffe automatique au cours de la mesure. N'appliquez pas de courant en dehors de cette plage. Le cas échéant, un endommagement de l'équipement risquerait de se produire.
- La plage d'entrée continue maximale varie en fonction de la fréquence de l'intensité mesurée. Reportez-vous aux spécifications du produit (p. 36).
- Si un courant dépassant la plage d'entrée continue maximale est appliqué, la fonction de protection interne est activée suite à la chaleur générée par le capteur et la sonde ne donne pas de valeur correcte. Le cas échéant, retirez immédiatement l'entrée (retirez la tête du capteur du conducteur ou remettez le courant d'entrée à zéro). La période de refroidissement adéquate sera requise jusqu'à ce que la sonde puisse donner à nouveau des valeurs correctes.
- Dans un environnement de température élevée, le circuit de protection contre la surintensité interne peut être activé même à des intensités comprises dans la plage d'entrée continue maximale.
- Si un courant dépassant la plage d'entrée continue maximale est appliqué en continu ou si la fonction de protection est régulièrement activée, l'équipement risque de se casser.
- En plus de la plage d'entrée continue maximale, les spécifications du produit indiquant la plage d'entrée maximale comprennent le « pic d'intensité maximale discontinue de 7,5 A ». Cela signifie que la limite supérieure de la réponse de forme d'onde est un pic de 7,5 A. Utilisez la sonde de manière à ce que la valeur rms ne dépasse pas la plage d'entrée continue maximale.
- Assurez-vous d'utiliser le levier d'ouverture pour ouvrir la tête du capteur. Le fait d'appuyer sur le noyau supérieur lorsque la tête du capteur est verrouillée endommage le mécanisme de serrage.

- N'exercez pas de force sur la tête du capteur dans le sens indiqué sur la figure ci-dessous.

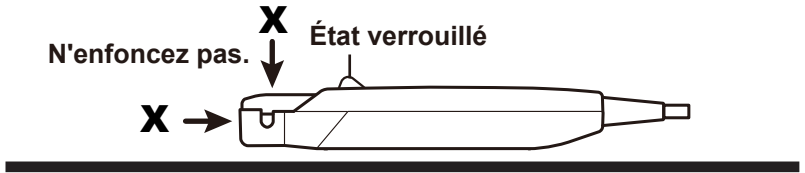

Before measuring, check that there are no problems with the instrument or the measurement target and that measurement preparations have been taken.

1. Pull the sensor opening lever to open the sensor head.
2. Align the direction of the arrow of the current direction mark indicated at the sensor tip to the direction of the measured current, and clamp so that the conductor is at the center of the sensor aperture.

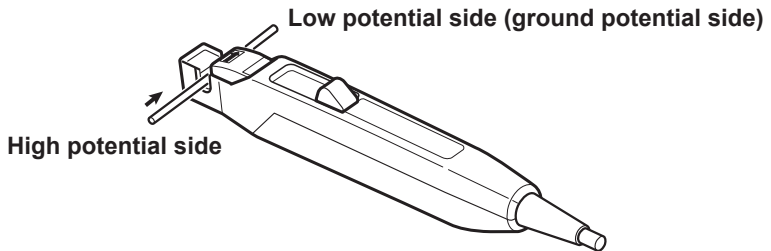

3. Hold down the sensor opening lever until the JAW UNLOCKED indication disappears to lock the sensor head.
The JAW UNLOCKED LED turns off.
4. You can observe the current waveform on the waveform measuring instrument. The output voltage rate of the 701917 and 701918 is 1 V/A. Convert the voltage sensitivity of the waveform measuring instrument to current sensitivity.
For example, if the voltage sensitivity of the waveform measuring instrument is 10 mV/DIV, the current sensitivity is 10 mA/DIV.

Note

- The instrument's output is internally terminated. Use a waveform measuring instrument with an input impedance of 1 M Ω or higher.
- The offset drift may be large immediately after starting to supply power due to instrument's self-heating and other effects, but it will stabilize for the most part in about 30 minutes.
- The offset voltage will drift due to the ambient temperature or the like, so careful attention is required when performing continuous measurement.
- On rare occasions, connecting the power plug to the power supply that is turned on may cause oscillation, but this is not a malfunction. If this occurs, you can open and close the sensor head with the opening lever to stop the oscillation and restore normal operation.
- Depending on the current frequency that is measured, resonant sound may occur, but this has no effect on measurements.
- In the high frequency region, the probe may be affected by common-mode noise by clamping the high potential side of an electric circuit. If necessary, limit the bandwidth of the waveform measuring instrument, or clamp the low potential side.

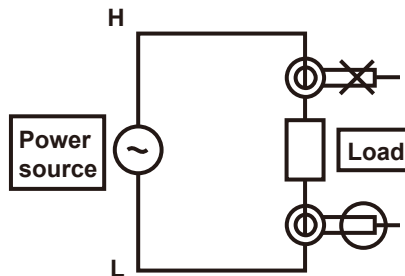

- Accurate measurements may not be possible near objects with strong electromagnetic fields such as transformers, large current circuits, and wireless equipment.

- When measuring DC or low-frequency, low current, winding the conductor several times will increase the relative sensitivity. If the conductor is wound 10 times, the probe will output 10 times the measured current. However, wind the conductor radially at a diameter of at least 20 cm.

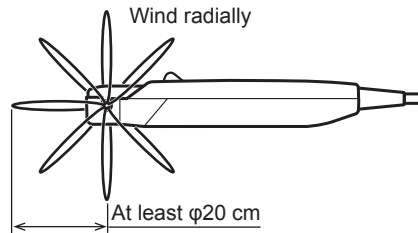

- The measured value may be affected by the conductor position within the sensor aperture. Position the conductor at the center of the sensor window, and make the straight portion as long as possible. Avoid positioning the conductor so that it is wound locally around the sensor head.
- To make accurate measurements, hold down the opening lever until the JAW UNLOCKED indicator disappears to ensure that the sensor head is securely closed and locked.
- Conductor clamping and cable positioning may cause load fluctuations, affecting the observed waveform.
- An offset voltage fluctuation of about 1 mV may occur when the sensor is opened or closed. To make high accurate measurements, perform the steps below before clamping the conductor.
 - When closing the sensor, operate the lever slowly so that strong shock is not applied to the sensor head. Operating the lever rapidly may increase the offset voltage variation due to the shock.
 - Wait about 5 minutes for the offset drift to stabilize after the completion of demagnetization and zero adjustment.
 - With the opening lever, open and close the sensor four or five times to allow the sensor to adapt.
 - Press DEMAG/AUTO ZERO to execute only zero adjustment (do not hold down the key).
- To prevent offset voltage variation from occurring, make sure that force is not applied to the jaw or opening lever during measurement.

Ending Measurement

Notes on Ending Measurement

To remove the instrument's power cable from the power supply, pull the power cable shell.



CAUTION

- To prevent breaking the cable, do not pull the cable when removing the output terminal from the waveform measuring instrument. Be sure remove by holding the terminator and pulling the lock release lever toward you.
 - To prevent breaking the instrument's power cable, probe power supply terminal of the waveform measuring instrument, and the power supply receptacle of the 701934 or 700938 power supply, observe the following when removing the power cable.
 - Hold the power plug shell (p. 19) and remove.
 - Do not pull the cable or rotate the power plug. (Pulling the power plug shell releases the lock allowing you to remove it from the power supply receptacle.)
-

French



ATTENTION

- Afin d'éviter de casser le câble, ne tirez pas sur le câble lorsque vous retirez la borne de sortie de l'équipement de mesure de la forme d'onde. Assurez-vous que vous retirez le dispositif en maintenant le terminateur et en tirant vers vous le levier de déverrouillage.

- Afin d'éviter de casser le câble d'alimentation de l'équipement, la borne d'alimentation de la sonde de l'équipement de mesure de la forme d'onde et la prise de secteur de l'alimentation 701934 ou 700938, respectez les consignes ci-dessous lorsque vous retirez le câble d'alimentation.
 - Tenez le boîtier de la fiche secteur (p. 19) et retirez le dispositif.
 - Ne tirez pas sur le câble et ne faites pas pivoter la fiche secteur. (Le fait de tirer sur le boîtier de la fiche secteur entraîne un déverrouillage qui vous permet de le retirer de la prise secteur.)
-

- 1.** Pull the opening lever toward you, and remove the instrument from the conductor.
- 2.** Remove the terminator from the waveform measuring instrument. Pull the lock release lever toward you, and pull the terminator straight out.

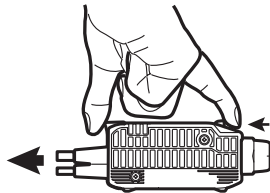

- 3.** Turn off the waveform measuring instrument with a probe power supply or the 701934/700938 power supply.
- 4.** Remove the instrument's power plug.
Hold the power plug shell and remove.
Do not pull the cable or rotate the power plug.

Specifications

Product Specifications

Accuracy values are at 23 ±5 °C, 30 minutes after turning on the power.

| Item | 701917 | 701918 |
|-------------------------------------------------|-----------------------------------------------------------------------------------------------------|-----------------------------------------------------------------------|
| Frequency band* | DC to 50 MHz (–3 dB) (For the response example, see page 38.) | DC to 120 MHz (–3 dB) (For the response example, see page 38.) |
| Rise time* | 7 ns or less | 2.9 ns or less |
| Delay time | 10 ns | |
| Continuous maximum input | 5 Arms (DC and sine wave) (For frequency derating, see page 39.) | |
| Maximum peak current | 7.5 A _{peak} , discontinuous | |
| Output voltage rate* | 1 V/A | |
| Amplitude accuracy* | ±3.0% of reading ±1 mV (DC, 45 to 66 Hz, 0 to 5 Arms) (typical 1.0% of reading ±1 mV) | |
| Noise* | 75 μArms equivalent or less (typical 60 μArms) (with a 30 MHz band measuring instrument) | |
| Insertion impedance | (For the example of characteristics, see page 41.) | |
| Sensitivity temperature characteristics* | Within ±2% of reading (with 50 Hz, 5 Arms input after zero adjustment over a range except 23 ±5 °C) | |
| Maximum rated power | 3.2 VA (with the maximum input) | |
| Rated supply voltage | ±12 V ±0.5 V | |
| Operating temperature and humidity | 0 to 40 °C, 80% RH or less (no condensation) | |
| Storage temperature and humidity | –10 to 50 °C, 80% RH or less (no condensation) | |
| Operating location | Indoor use, altitude up to 2000 m | |
| Effect of external magnetic fields | Up to 20 mA or equivalent (DC and 60 Hz, magnetic field of 400 A/m) | Up to 5 mA or equivalent (DC and 60 Hz, magnetic field of 400 A/m) |
| Measurable conductors | Insulated conductors | |
| Measurable diameter of conductors | φ5 mm or less | |
| Recommended calibration period | 1 year (10000 open and close operations) | |
| Cable length | Sensor cable: approx. 1.5 m Power cable: approx. 1 m | |
| External dimensions | Sensor: approx. 155 (W) × 18 (H) × 26 (D) mm Terminator: approx. 29 (W) × 83 (H) × 40 (D) mm | |
| Weight | Approx. 250 g | |
| Standard accessories | User's manual and carrying case | |

* In combination with a 1 MΩ ±1% input impedance waveform measuring instrument

Compliant Standards

| | |
|--------------------------------------------|--------------------------------------------------------------------------------------------------------------------------------------------------------|
| Safety standards | EN 61010-1 EN IEC 61010-2-032 Type D Pollution degree 2 ¹ |
| EMC standards | Emissions EN 61326-1 Class B EN 55011 Class B Group 1 EMC Regulatory Arrangement in Australia and New Zealand EN 55011 Class B Group 1 |
| | Immunity EN 61326-1 Table 1 (Basic immunity requirement) |
| Environmental standards² | EU RoHS Directive compliant |

- 1 Pollution degree applies to the degree of adhesion of a solid, liquid, or gas which deteriorates withstand voltage or surface resistivity. Pollution degree 2 applies to normal indoor atmospheres (usually with only non-conductive pollution).
- 2 For conformity to environmental regulations and/or standards other than EU, contact your local Yokogawa office (PIM 113-01Z2).

External Dimensions

Unit: mm

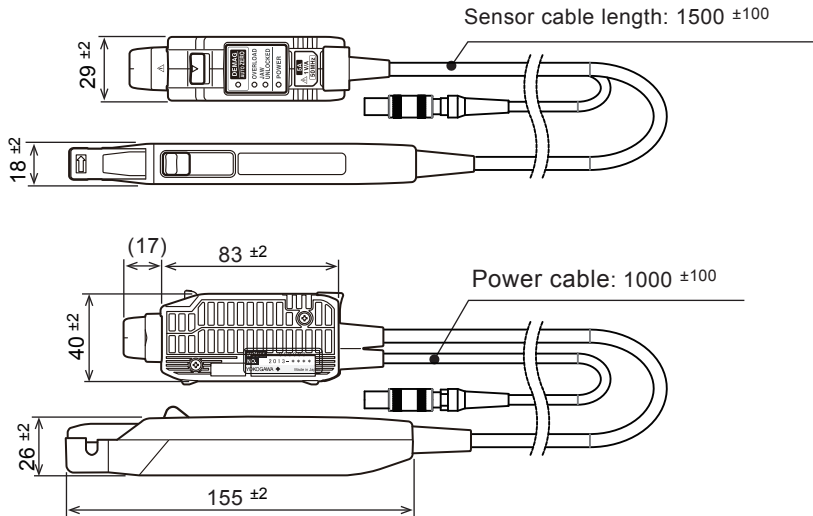

Unless otherwise specified, tolerances are ±3% (however, tolerances are ±0.3 mm when below 10 mm).

Characteristics

Frequency Response

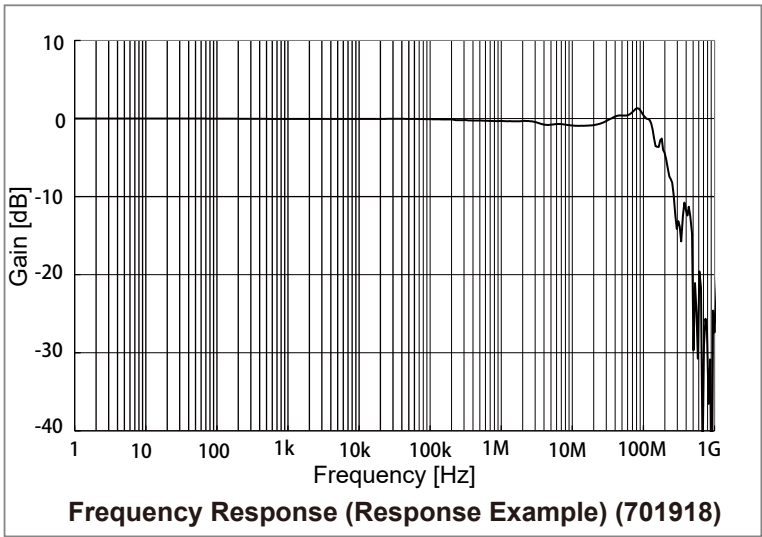
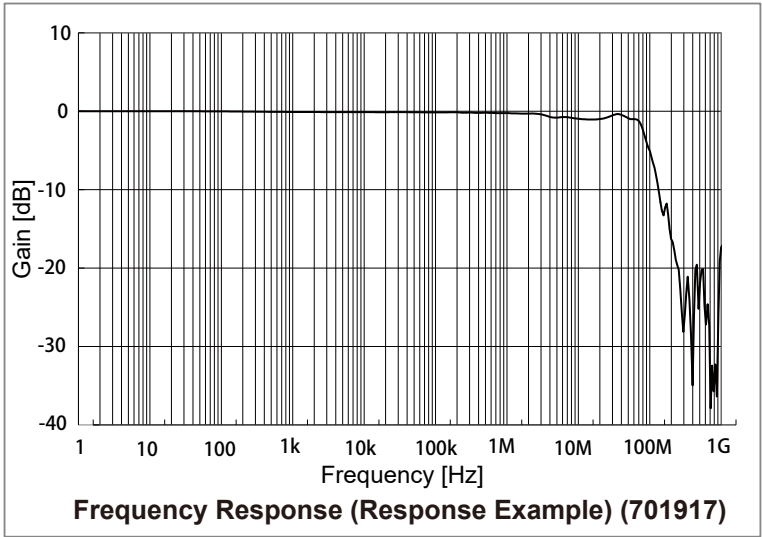

Frequency Derating

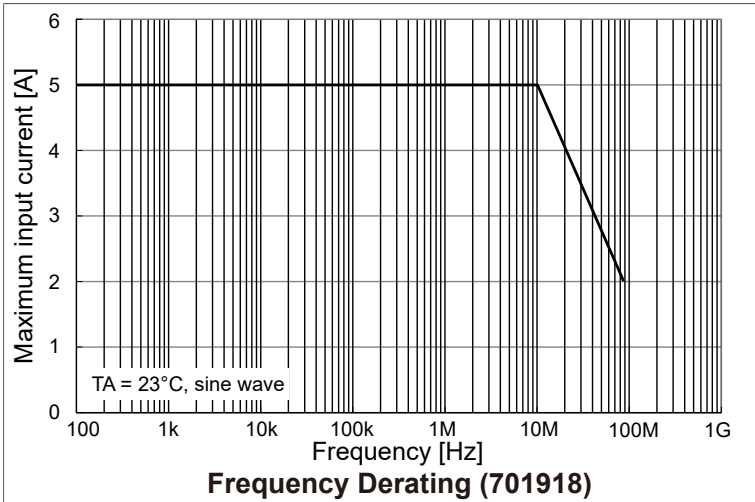
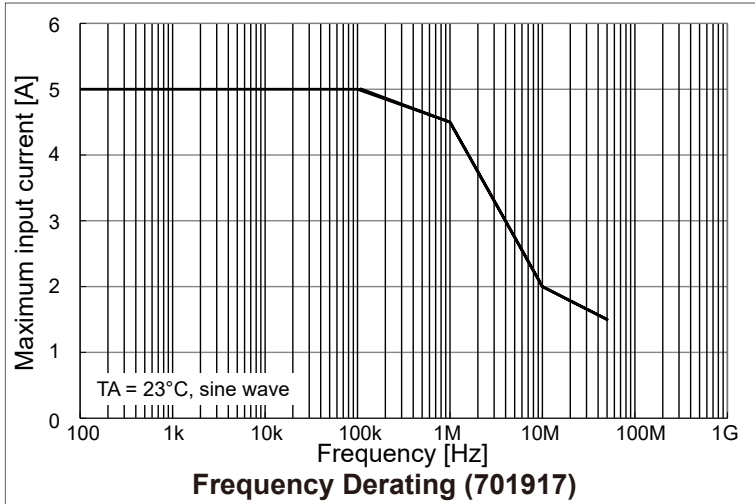

Note

The frequency derating graph is for accuracy-guaranteed temperature (23 °C ±5 °C) and sine input. Use this as reference data.

If the ambient temperature (TA) increases or if the current to be measured includes high frequency components, the instrument's temperature also increases, lowering the current and frequency that can be applied continuously.

1 mA measurement waveform

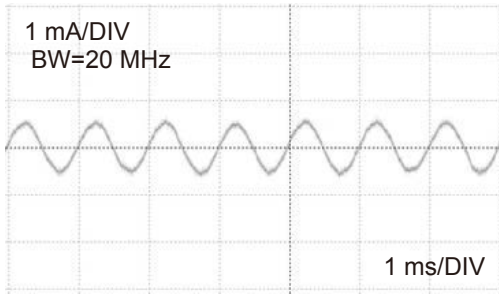

Insertion Impedance

The location clamped with this instrument has the following impedance (load). Be particularly careful during high frequency measurement.

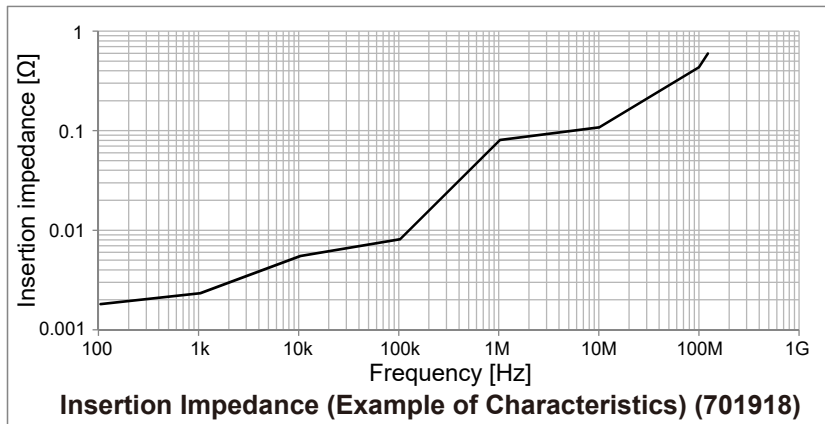
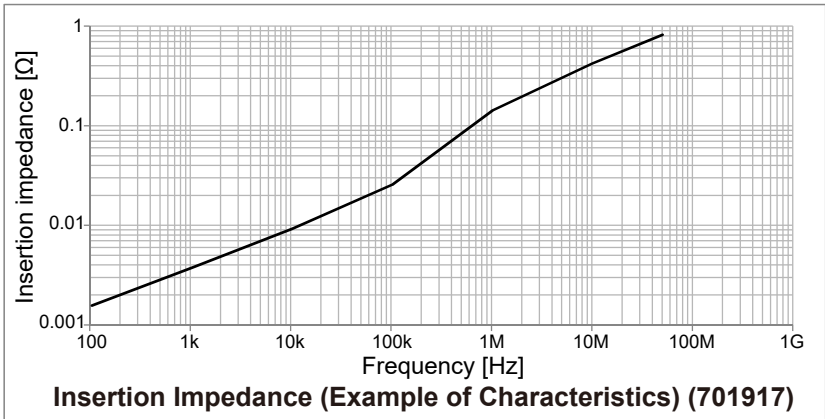

Effect of Common-Mode Voltage on Conductor Being Measured (inside the sensor)

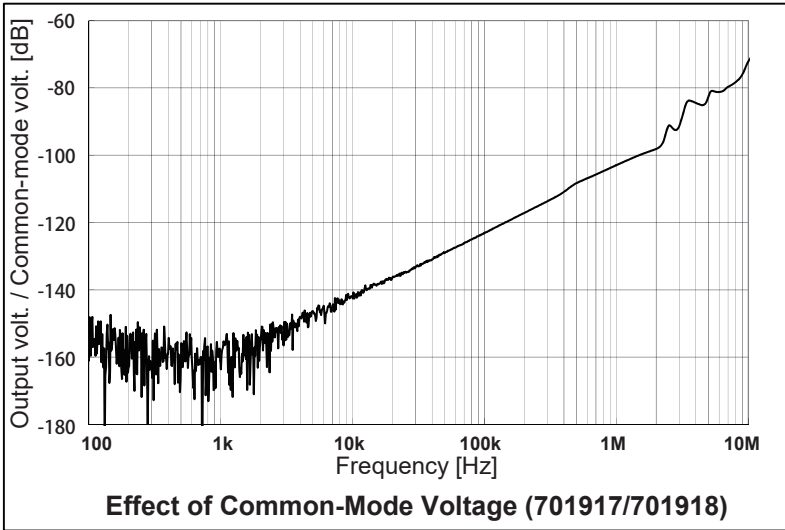

Functions

| | |
|--------------------------------------------|-----------------------------------------------------------------------------------------------------------------------------------------------------------------------------------------------------------------------------------------------------------------------------------------------------------------------------------------------------------------------|
| Demagnetization and zero adjustment | Demagnetization and zero adjustment Operation: Performs demagnetization and zero adjustment. Procedure: Press and hold DEMAG/AUTO ZERO for at least 500 ms (typical). |
| | Zero adjustment Operation: Performs zero adjustment. Procedure: Press and hold DEMAG/AUTO ZERO for at least 20 ms but less than 500 ms (typical). |
| | Cannot be performed in the following circumstances: <ul style="list-style-type: none"> • When the sensor head is not locked (when the JAW UNLOCKED LED is lit) • When overloaded (when the OVERLOAD LED is blinking) • When a current measurement exceeding 0.50 ± 0.25 A rms (DC, 45 to 66 Hz sine wave) is detected |
| DEMAG/AUTO ZERO LED | |
| | Slow blinking orange: After the device is powered on, after input in excess of ratings is removed, and after demagnetization completes abnormally |
| | Solid orange: Demagnetization and zero adjustment in progress |
| | Off: Demagnetization and zero adjustment completed |
| Sensor head unlocked detection | The JAW UNLOCKED LED lights red when the sensor head is not locked. |
| Power detection | The POWER LED lights green when the probe is receiving power. |
| Overload detection | Sampling frequency: 7.8125 kHz (typical) Confirmation cycle : 500 ms (typical) (sampling: 400 ms (typical); calculation and judgment: 100 ms (typical)) |

Specifications

Rating warning

Indicates that the maximum rated current is about to be reached.

OVERLOAD LED: Red, slow blinking

Blinking conditions: If prescribed level 1 is exceeded

Prescribed level 1: 4.75 ± 0.25 A rms (DC, 45 to 66 Hz sine wave)

Rating exceeded

Indicates that the maximum rated current has been exceeded.

OVERLOAD LED: Red, fast blinking

Blinking conditions: If prescribed level 2 is exceeded

Prescribed level 2: 5.25 ± 0.25 A rms (DC, 45 to 66 Hz sine wave)

Temperature exceeded

Indicates that abnormal internal temperature has been detected.

Set temperature: 80°C (typical)

Hysteresis: 10°C (typical)

LED : All LEDs except the POWER LED blinking

Recovery method: Remove the instrument from the conductor being measured, allow it to cool off, and press DEMAG/AUTO ZERO. This will return the instrument to the initial state (power-on state).

Troubleshooting

- If damage is suspected, check “Before Sending the Instrument for Repair” before contacting your nearest YOKOGAWA dealer.
- If no waveform is displayed even after performing demagnetization and zero adjustment, the instrument may be damaged. Contact your nearest YOKOGAWA dealer.

Before Sending the Instrument for Repair

| Symptom | Check and Corrective Action | | | | | | | |
|-----------------------------------------------------------------------------|--------------------------------------------------------------------------------------------------------------------------------------------------------------------------------------------------------------------------------------------------------------------------------------------------------------------------------------------------------------------------------------------------------------------------------------------------------------------------------|---------------------------------------------------------------------------------------------|-------------------|------------------------------|---------------------------------------------------------------------------------------------|-------------------------------|----------------------------------------------------------|-----------------------------------------------|
| No waveform is displayed on the connected waveform measuring instrument. | <ul style="list-style-type: none"> • Perform demagnetization and zero adjustment again. • Verify that the waveform measuring instrument’s input coupling is set to DC. If this does not resolve the issue, the instrument may be damaged. Have it repaired. | | | | | | | |
| A resonant sound is emitted by the sensor head. | A resonant sound may be emitted depending on the amplitude and frequency of the current being measured. It may also be emitted during demagnetization. This does not affect measurement. | | | | | | | |
| The resonant sound emitted by the sensor head has grown louder. | The spacing between the upper and lower sensors may have widened. The sensor characteristics may change, so we recommend calibrating the sensor. | | | | | | | |
| The positive and negative sides of demagnetization waveform are asymmetric. | This is not a malfunction. After demagnetization and zero adjustment, verify that the zero position of the waveform measuring instrument is at the correct position. | | | | | | | |
| Demagnetization and zero adjustment do not complete normally. | Demagnetization and automatic zero adjustment cannot be performed in the following circumstances: Perform the following corrective action, and then perform demagnetization and zero adjustment again. | | | | | | | |
| | <table border="1"> <thead> <tr> <th>Condition</th> <th>Corrective Action</th> </tr> </thead> <tbody> <tr> <td>The JAW UNLOCKED LED is lit.</td> <td>Lock the sensor head. (Press the opening lever until the JAW UNLOCKED indicator turns off.)</td> </tr> <tr> <td>The OVERLOAD LED is blinking.</td> <td rowspan="2">Remove the instrument from the conductor being measured.</td> </tr> <tr> <td>A current of 0.5 Arms or higher was detected.</td> </tr> </tbody> </table> | Condition | Corrective Action | The JAW UNLOCKED LED is lit. | Lock the sensor head. (Press the opening lever until the JAW UNLOCKED indicator turns off.) | The OVERLOAD LED is blinking. | Remove the instrument from the conductor being measured. | A current of 0.5 Arms or higher was detected. |
| | Condition | Corrective Action | | | | | | |
| | The JAW UNLOCKED LED is lit. | Lock the sensor head. (Press the opening lever until the JAW UNLOCKED indicator turns off.) | | | | | | |
| The OVERLOAD LED is blinking. | Remove the instrument from the conductor being measured. | | | | | | | |
| A current of 0.5 Arms or higher was detected. | | | | | | | | |
| | | | | | | | | |
| | If demagnetization and zero adjustment do not complete normally even when current is not being measured, the instrument is broken. Have it repaired. | | | | | | | |

Errors

You can determine the nature of an error by observing the instrument's LED. If an error occurs, follow the instructions in the table below. If the instrument needs to be repaired, contact your nearest YOKOGAWA dealer.

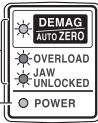
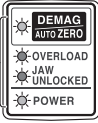
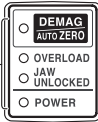
| Error State | Corrective Action |
|--------------------------------------------------------------------------------------------------------------------------------|---------------------------------------------------------------------------------------------------------------------------------------------------------------------------------------------------------------------------------------------------------------------------------------------------------------------------------------------------------------------------------------------------------------------------------------------------------------------------------------------|
| <p>Continuous fast blinking</p> <p>Solid</p>  | <p>Abnormal temperature has been detected due to internal heating caused by overloading. Remove the instrument from the conductor immediately. Wait for the instrument to cool under no input condition, and then press DEMAG/AUTO ZERO. This will return the instrument to the power-on state. Perform demagnetization and zero adjustment again before starting measurement. The internal components may have been subject to stress. We recommend that you calibrate the instrument.</p> |
| <p>Continuous fast blinking</p>  | <p>Internal CPU error (checksum error). Have it repaired.</p> |
| <p>Off even when powered</p>  | <p>The instrument has malfunctioned. Have it repaired.</p> |

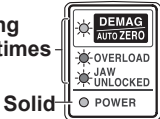
| Error State | Corrective Action | | | | | | | |
|---------------------------------------------------------------------------------------------------------------------------------|------------------------------------------------------------------------------------------------------------------------------------------------------------------------------------------------------------------------------------------------------------------------------------------------------------------------------------------------------------------------------------------------------------------------------------------------------------------------------------------------------------------------------------------------------------------------------------------------------------------------------------------------------------------------------------------------------------------------------------------------------------------------------------------------------------------------------------------------------------------------------------------------------------------------------------------------|--|-----------|-------------------|------------------------------|---------------------------------------------------------------------------------------------|--------------------------------------------------------------------------------|----------------------------------------------------------|
| <p>Fast blinking three times</p>  <p>Solid</p> | <p>This occurs when you press DEMAG/AUTO ZERO under the circumstances described in the table below. Demagnetization and automatic zero adjustment cannot be performed. Perform the following corrective action, and then perform demagnetization and zero adjustment (p. 25) again.</p> <table border="1" data-bbox="468 375 996 678"> <thead> <tr> <th data-bbox="468 375 728 406">Condition</th> <th data-bbox="728 375 996 406">Corrective Action</th> </tr> </thead> <tbody> <tr> <td data-bbox="468 406 728 555">The JAW UNLOCKED LED is lit.</td> <td data-bbox="728 406 996 555">Lock the sensor head. (Press the opening lever until the JAW UNLOCKED indicator turns off.)</td> </tr> <tr> <td data-bbox="468 555 728 678">The OVERLOAD LED is blinking. A current of 0.5 Arms or higher was detected.</td> <td data-bbox="728 555 996 678">Remove the instrument from the conductor being measured.</td> </tr> </tbody> </table> | | Condition | Corrective Action | The JAW UNLOCKED LED is lit. | Lock the sensor head. (Press the opening lever until the JAW UNLOCKED indicator turns off.) | The OVERLOAD LED is blinking. A current of 0.5 Arms or higher was detected. | Remove the instrument from the conductor being measured. |
| Condition | Corrective Action | | | | | | | |
| The JAW UNLOCKED LED is lit. | Lock the sensor head. (Press the opening lever until the JAW UNLOCKED indicator turns off.) | | | | | | | |
| The OVERLOAD LED is blinking. A current of 0.5 Arms or higher was detected. | Remove the instrument from the conductor being measured. | | | | | | | |