



LCR Meter

4310 4320 4350 43100

User Manual

Issue 1.3

19th December 2008

Part N° 9H4300

WAYNE KERR WORLDWIDE:

UK – GLOBAL HQ

Wayne Kerr Electronics
Vinnetrow Business Park
Vinnetrow Road
Chichester
West Sussex PO20 1QH

Tel: +44 (0)1243 792200

Fax: +44 (0)1243 792201

Email: sales@wayne-kerr.co.uk

Email: service@wayne-kerr.co.uk

USA

Wayne Kerr Electronics Inc.
165L New Boston Street
Woburn MA 01801-1744

Tel: 781 938 8390

Fax: 781 933 9523

Email: sales@waynekerrusa.com

China

Wayne Kerr Asia
A604 Pengdu Building,
Guimiao Road,
Nanshan District,
Shenzhen, Guangdong
China

Tel: +86 138 2525 7230

Fax: +86 755 2652 3875

Email: sales@waynekerr.com

service@waynekerr.com

Europe

Wayne Kerr Europe GmbH
Märkische Str. 38 - 40
58675 Hemer
Germany

Tel: +49 (0) 2372 557 870

Fax: +49 (0) 2372 557 8790

E-mail: info@waynekerr.de

Taiwan

Wayne Kerr Electronics Corporation
No228-21, Sec 2, Bei Hsin Rd
Hsin Tien City
Taipei 231
Taiwan

Tel: +886 (2) 2915 8990

Fax: +886 (2) 2915 5775

E-mail: sales@waynekerrtest.com.tw

India

Wayne Kerr Electronics Pvt Ltd
FF-73, Amrit Plaza Commercial Complex
B Block, Surya Nagar
Ghaziabad (UP)
India

Tel: +91 (0) 12 0262 9612

Fax: +91 (0) 12 0262 9613

E-mail: waynekerrindia@gmail.com

www.waynekerrtest.com

© Wayne Kerr Electronics 2009

The copyright in this work is vested in Wayne Kerr Electronics and this document is issued for the purpose only for which it is supplied. No licence is implied for the use of any patented feature. It must not be reproduced in whole or in part, or used for tendering or manufacturing purposes except under an agreement or with the consent in writing of and then only on the condition that this notice is included in any such reproduction. Information furnished is believed to be accurate but no liability in respect of any use of it is accepted by Wayne Kerr Electronics.

CONTENTS

1. SAFETY.....	1-1
1.1 General.....	1-1
1.2 AC Power Supply	1-2
1.3 Adjustment, Maintenance and Repair.....	1-2
1.4 Static Electricity.....	1-3
2. INTRODUCTION.....	2-1
3. INSTALLATION.....	3-1
3.1 SCHEDULE OF EQUIPMENT.....	3-1
3.2 AC Line Connections.....	3-1
3.3 Location	3-2
3.4 Measurement Connections.....	3-2
4. OPERATION	4-1
4.1 The Rear Panel.....	4-1
4.1.1 AC Power Inlet.....	4-1
4.1.2 Fuse Holder	4-2
4.1.3 Rear Panel Control Connections.....	4-2
4.1.4 DC Bias Input	4-2
4.1.5 USB	4-2
4.1.6 LAN	4-2
4.1.7 Trigger In.....	4-2
4.1.8 GPIB	4-3
4.1.9 RS-232 Connector.....	4-4
4.1.10 Bin Handler.....	4-4
4.2 The Front Panel.....	4-5
4.2.1 Switching the Instrument ON.....	4-6
4.2.2 Contrast adjustment.....	4-6
4.2.3 Switching the Instrument OFF.....	4-6
4.2.4 The Soft Keys	4-6
4.2.5 The Navigation Keys.....	4-7
4.2.6 The Control Keys	4-7
4.2.7 The Data Entry Keypad	4-8
4.3 Trimming	4-8
4.3.1 Performing an Open Circuit Trim and Short Circuit Trim	4-9
4.4 Measurement.....	4-11
4.4.1 Main Menu.....	4-12
4.4.2 Settings Page	4-12
4.4.3 Status Page	4-13
4.4.4 External Control Page.....	4-13
4.4.5 Measurement Screen.....	4-14
4.4.6 Set Pull Down Menu	4-14
4.4.7 Function 1.....	4-16
4.4.8 Function 2.....	4-17

4.4.9 Equivalent Circuit	4-17
4.4.10 Frequency.....	4-18
4.4.11 AC Drive Level.....	4-19
4.4.12 Measurement Speed	4-20
4.4.13 DC Bias Voltage.....	4-20
4.4.14 Range	4-21
4.4.15 DC Resistance	4-21
4.4.16 Option Pull Down Menu	4-23
4.4.17 Scale.....	4-23
4.4.18 External Control	4-25
4.4.19 Buzzer.....	4-25
4.4.20 More Pull Down Menu.....	4-26
4.4.21 Recall	4-26
4.4.22 Save	4-27
4.4.23 Binning (option).....	4-27
4.4.24 Binning – Set	4-28
4.4.25 Binning – Sort	4-35
4.4.26 Binning - Count.....	4-36
5. REMOTE CONTROL (GPIB & RS-232)	5-1
5.1 RS-232 Control	5-1
5.1.1 Introduction.....	5-1
5.1.2 Protocol.....	5-1
5.1.3 Commands.....	5-1
5.2 GPIB Control	5-2
5.2.1 Introduction.....	5-2
5.2.2 Interface Specification	5-2
5.2.3 GPIB Address.....	5-2
5.2.4 Message Syntax.....	5-2
5.2.5 Data Output.....	5-6
5.2.6 Status Reporting.....	5-6
5.2.7 Common Commands	5-11
5.2.8 Standard Operation Status Commands.....	5-12
5.3 4300 Device-Specific Commands	5-13
5.3.1 Command Summary	5-13
MEASUREMENT MODE.....	5-14
CALIBRATE MODE.....	5-20
ROOT COMMANDS.....	5-21
6. BINNING	6-1
6.1 OVERVIEW	6-1
6.2 BIN TYPES.....	6-1
6.2.1 ONE TERM BIN TYPE.....	6-1
6.2.2 ONE TERM DUAL LIMITS BIN TYPE.....	6-3
6.2.3 TWO TERM BIN TYPE	6-5
6.3 SIGNALS	6-7
6.3.1 CONTROL INPUT:.....	6-7
6.3.2 TEST RESULT OUTPUT:.....	6-7
6.3.3 CONTROL OUTPUT:.....	6-7

6.3.4	<i>ELECTRICAL RATINGS</i>	6-7
6.3.5	<i>TIMING DIAGRAM:</i>	6-8
6.4	<i>SORT</i>	6-10
6.5	<i>COUNT</i>	6-10
7.	4300 LCR METER SPECIFICATION	7-1
7.1	Measurement Parameters	7-1
7.1.1	<i>AC Functions</i>	7-1
7.1.2	<i>Series or Parallel Equivalent Circuit</i>	7-1
7.1.3	<i>Polar Form</i>	7-1
7.1.4	<i>DC Function</i>	7-1
7.2	AC Drive Signal.....	7-1
7.2.1	<i>Frequency Range and Points</i>	7-1
7.2.2	<i>Frequency Accuracy</i>	7-2
7.2.3	<i>Frequency Step Size</i>	7-2
7.2.4	<i>AC Drive Level</i>	7-2
7.2.5	<i>Source Impedance</i>	7-2
7.2.6	<i>DC Drive Level (Rdc)</i>	7-2
7.2.7	<i>DC Bias Voltage</i>	7-2
7.3	Measurement Speed.....	7-3
7.4	Measurement Range	7-3
7.5	Modes Of Operation	7-4
7.5.1	<i>Measurement</i>	7-4
7.5.2	<i>Binning (Option)</i>	7-4
7.5.3	<i>Save and Recall</i>	7-5
7.6	Measurement Connections.....	7-5
7.7	Measurement Accuracy	7-5
7.7.1	<i>R/ G / Y / Z Accuracy Chart</i>	7-6
7.7.2	<i>Rdc Accuracy</i>	7-7
7.8	General.....	7-7
7.8.1	<i>AC Input</i>	7-7
7.8.2	<i>Display</i>	7-7
7.8.3	<i>Remote Control</i>	7-7
7.8.4	<i>Remote Trigger</i>	7-7
7.8.5	<i>Mechanical</i>	7-7
7.9	Environmental conditions	7-8
7.9.1	<i>Temperature Range</i>	7-8
7.9.2	<i>Relative Humidity</i>	7-8
7.9.3	<i>Altitude</i>	7-8
7.9.4	<i>Installation Category</i>	7-8
7.9.5	<i>Pollution Degree</i>	7-8
7.9.6	<i>Safety</i>	7-8
7.9.7	<i>EMC</i>	7-8
8.	THEORY REFERENCE	8-1
8.1	Abbreviations	8-1
8.2	Formulae	8-1
8.3	Series/Parallel Conversions	8-2
8.4	Polar Derivations	8-2

9. MAINTENANCE, SUPPORT AND SERVICES	9-1
9.1 Guarantee	9-1
9.2 Maintenance	9-1
9.2.1 <i>Cleaning</i>	9-1
9.2.2 <i>Safety Checks</i>	9-1
9.3 Support and Service	9-2

ILLUSTRATIONS

Figure 2-1 4300 LCR Meter	2-1
Figure 4-1 The 4300 Rear Panel	4-1
Figure 4-2 The 4300 Front Panel	4-5
Figure 4-3 The Soft Keys.....	4-6
Figure 4-4 The Navigation Keys.....	4-7
Figure 4-5 Connections for O/C trimming of Kelvin clips.....	4-9
Figure 4-6 Connections for S/C trimming of Kelvin clips	4-9
Figure 4-7 Calibrate Pull Down Menu	4-9
Figure 4-8 Open Circuit Trim Page	4-10
Figure 4-9 Open Circuit Trim in progress	4-10
Figure 4-10 Short Circuit Trim Page	4-11
Figure 4-11 Short Circuit Trim in progress	4-11
Figure 4-12 Main Menu Page	4-12
Figure 4-13 Main Menu Page	4-12
Figure 4-14 Status Page example.....	4-13
Figure 4-15 External Control Page	4-13
Figure 4-16 Typical Measurement Screen.....	4-14
Figure 4-17 Set Pull Down Menu and Soft Keys	4-14
Figure 4-18 Function 1 Selection Page.....	4-16
Figure 4-19 Function 2 Selection Page.....	4-17
Figure 4-20 Equivalent Circuit Selection Page.....	4-17
Figure 4-21 Frequency Setting Page 1 st stage.....	4-18
Figure 4-22 Frequency Setting Page 2 nd stage	4-18
Figure 4-23 AC Drive Level Setting Page 1 st stage.....	4-19
Figure 4-24 AC Drive Level Setting Page 2 nd stage	4-19
Figure 4-25 Measurement Speed Selection Page	4-20
Figure 4-26 DC Bias Voltage Selection Page.....	4-20
Figure 4-27 Hardware Range Selection Page	4-21
Figure 4-28 Rdc Measurement Screen.....	4-21
Figure 4-29 DC Resistance Selection Page	4-22
Figure 4-30 Option Pull Down Menu	4-23
Figure 4-31 Scale Initial Page.....	4-23
Figure 4-32 Bar Graph explanation	4-24
Figure 4-33 External Control Selection Screen	4-25
Figure 4-34 More Pull Down Menu	4-26
Figure 4-35 Recall Screen.....	4-26
Figure 4-36 Save Screen	4-27
Figure 4-37 Binning Mode screen	4-28
Figure 4-38 Bin Types screen.....	4-28
Figure 4-39 One Term selection screen.....	4-29
Figure 4-40 One Term Dual Limits selection screen.....	4-29
Figure 4-41 Two Term selection screen	4-29
Figure 4-42 One Term Absolute limits screen.....	4-30
Figure 4-43 One Term Percentage Limits screen	4-30
Figure 4-44 One Term Save Result screen	4-31
Figure 4-45 One Term Dual Limits Absolute limits screen	4-32
Figure 4-46 One Term Dual Limits Percentage Limits screen.....	4-32

Figure 4-47 One Term Dual Limits Save Result screen	4-33
Figure 4-48 Two Term Absolute limits screen	4-33
Figure 4-49 Two Term Percentage Limits screen.....	4-34
Figure 4-50 Two Term Save Result screen.....	4-35
Figure 4-51 Sort screen example.....	4-35
Figure 4-52 Count screen example	4-36
Figure 5-1 GPIB Message Structure	5-3
Figure 5-2 GPIB Command Structure.....	5-3
Figure 5-3 GPIB Data Output	5-6
Figure 5-4 GPIB RMU Structure	5-6
Figure 5-5 Status Byte Register	5-7
Figure 5-6 Standard Event Status Register	5-8
Figure 5-7 Event Status Byte Register.....	5-9
Figure 5-8 Standard Operation Status Group.....	5-10
Figure 6-1 One Term Bin Type diagram.....	6-1
Figure 6-2 One Term Bin Type two axis diagram	6-2
Figure 6-3 One Term Bin Type flow chart	6-2
Figure 6-4 One Term Dual Limits Bin Type diagram	6-3
Figure 6-5 One Term Dual Limits Bin Type two axis diagram.....	6-3
Figure 6-6 One Term Dual Limits Bin Type flow chart	6-4
Figure 6-7 One Term Dual Limits Bin Type diagram	6-5
Figure 6-8 Two Term Bin Type two axis diagram	6-5
Figure 6-9 Two Term Bin Type flow chart.....	6-6
Figure 6-10 Binning Timing diagram	6-8
Figure 6-11 Sort Screen	6-10
Figure 6-12 Count Screen	6-10

1. SAFETY

1.1 General

This equipment has been designed to meet the requirements of EN61010-1 'Safety requirements for electrical equipment for measurement, control & laboratory use' and has left the factory in a safe condition.

The following definitions in EN61010-1 are applicable:

OPERATOR	Person operating equipment for its intended purpose. Note: The OPERATOR should have received training appropriate for this purpose.
RESPONSIBLE BODY	Individual or group responsible for the use and maintenance of equipment and for ensuring that operators are adequately trained.

The RESPONSIBLE BODY must ensure that this equipment is only used in the manner specified. If it is not used in such a manner, the protection provided by the equipment may be impaired.

This product is not intended for use in atmospheres which are explosive, corrosive or adversely polluted (e.g. containing conductive or excessive dust). It is not intended for use in safety critical or medical applications.

The equipment can cause hazards if not used in accordance with these instructions. Read them carefully and follow them in all respects.

Do not use the equipment if it is damaged. In such circumstances the equipment must be made inoperative and secured against any unintentional operation.

Wayne Kerr Electronics and the associated sales organizations accept no responsibility for personal or material damage, nor for any consequential damage that results from irresponsible or unspecified operation or misuse of this equipment.

1.2 AC Power Supply

Power cable and connector requirements vary between countries. Always use a cable that conforms to local regulations, terminated in an IEC320 connector at the instrument end.

If it is necessary to fit a suitable AC power plug to the power cable, the user must observe the following colour codes:

WIRE	EUROPEAN	N. AMERICAN
LIVE	BROWN	BLACK
NEUTRAL	BLUE	WHITE
GROUND	GREEN/YELLOW	GREEN

The user must also ensure that the protective ground lead would be the last to break should the cable be subject to excessive strain.

If the plug is fused, a 3-amp fuse should be fitted.

If the power cable electrical connection to the AC power plug is through screw terminals then, to ensure reliable connections, any solder tinning of the cable wires must be removed before fitting the plug.

Before switching on the equipment, ensure that it is set to the voltage of the local AC power supply.

WARNING!

Any interruption of the protective ground conductor inside or outside the equipment or disconnection of the protective ground terminal is likely to make the equipment dangerous. Intentional interruption is prohibited.

1.3 Adjustment, Maintenance and Repair

WARNING!

The equipment must be disconnected from all voltage sources before it is opened for any adjustment, replacement, maintenance, or repair.

When the equipment is connected to the local AC power supply, internal terminals may be live and the opening of the covers or removal of parts (except those to which access can be gained by hand) is likely to expose live parts.

Capacitors inside the equipment may still be charged even if the equipment has been disconnected from all voltage sources.

Any adjustment, maintenance, or repair of the opened equipment under voltage must be carried out by a skilled person who is aware of the hazards involved.

Service personnel should be trained against unexpected hazards.

Ensure that only fuses with the required rated current and of the specified type are used for replacement. The use of makeshift fuses and short-circuiting of fuse holders is prohibited.

1.4 Static Electricity

The unit supplied uses static-sensitive devices. Service personnel should be alerted to components which require handling precautions to avoid damage by static electrical discharge.

Before handling circuit board assemblies containing these components, personnel should observe the following precautions:

- 1) The work surface should be a conductive grounded mat.
- 2) Soldering irons must be grounded and tools must be in contact with a conductive surface to ground when not in use.
- 3) Any person handling static-sensitive parts must wear a wrist strap which provides a leaky path to ground, impedance not greater than $1M\Omega$.
- 4) Components or circuit board assemblies must be stored in or on conductive foam or mat while work is in progress.
- 5) New components should be kept in the suppliers packaging until required for use

2. INTRODUCTION



Figure 2-1 4300 LCR Meter

The 4300 range of LCR Meters provides 4-terminal (Kelvin) measurement of passive components over a frequency range from 20Hz to 1MHz. There are four models in the range:

Model	Minimum frequency	Maximum frequency
4310	20Hz	100kHz
4320	20Hz	200kHz
4350	20Hz	500kHz
43100	20Hz	1MHz

For AC measurements, the measurement drive level can be varied from 10mV to 2Vrms, and DC resistance measurements can also be made. DC bias voltage can be applied during AC measurements; the preset internal level is 2V or the user can input an external supply of up to $\pm 40V$ via rear panel connectors.

The instrument's measurement, display and control facilities include:

- spot frequency measurements
- display of actual measurement values
- bar graph analogue display for easy adjustment of variable components
- bin handler (option)

All the above functions can be selected via manual front panel control and most can be selected using remote control via the GPIB and RS-232 interfaces for fully-automated high-speed testing.

3. INSTALLATION

3.1 SCHEDULE OF EQUIPMENT

The instrument has been carefully packed to prevent damage in transit. When removing the instrument from the packing box, ensure that all parts and accessories are removed from the packing material and have not been damaged. Retain the packing box and material.

The box will contain the following items as standard:

ITEM	WAYNE KERR PART No	QUANTITY
4310 (100kHz LCR Meter)	1J4310	1
4320 (200kHz LCR Meter)	1J4320	1
4350 (500kHz LCR Meter)	1J4350	1
43100 (1MHz LCR Meter)	1J43100	1
Power cord	To suit destination country	1
4300 User Manual	9H4300	1
Kelvin Leads	1EVA40150	1

Options will be fitted to instrument as ordered and additional accessories ordered may be packed in the same box or a separate box depending on size.

3.2 AC Line Connections

The unit is provided with a power cable capable of carrying the input current for both 115V and 230V operation. This cable should be connected via a suitable connector to the local AC power supply. The colour code employed is as follows:

WIRE	EUROPEAN	N. AMERICAN
LIVE	BROWN	BLACK
NEUTRAL	BLUE	WHITE
GROUND	GREEN/YELLOW	GREEN

No adjustment is required for variation of supply voltage or frequency.

Before connecting the AC power, read the precautions listed under section 1.2—AC Power Supply.

The instrument is not suitable for battery operation.

The power switch is located on the left of the front panel.

3.3 Location

The 4300 is intended for use either on the bench or in a rack. The instrument is convection cooled and care must be taken not to restrict any of the air inlet slots.

3.4 Measurement Connections

The 4300 can be used with any of the following Wayne Kerr leads, fixtures or adaptors. In each case ensure that the colour-coded BNC connectors are mated correctly with the corresponding front panel BNC's.

Kelvin Clip Leads Part No. 1EVA40150

General purpose 4-terminal measuring leads for conventional components giving good accuracy except for measurement of very small capacitances or very small inductances where the use of the 4-terminal component fixture, part number 1EV1006, will give better results.

Kelvin Clip Leads ((large jaws), Part No. 1EVA40180

Similar to part number 1EVA40150 but with larger jaws making them more suitable for connection to terminal posts or larger diameter component leads.

Four-Terminal Lead Set, Part No. 1EV1505

600mm screened cable terminated in four crocodile clips at the component end. Not recommended for use above 30kHz.

Four-Terminal Component Fixture, Part No. 1EV1006

Remote fixture with sliding jaws to accommodate both axial and radial leaded components. This fixture will give the greatest accuracy for 4-terminal measurements of conventional components. The jaws can be set to the component width for trimming and component measurements can be performed without moving the measuring leads: stable lead positioning is important when measuring low value inductors.

4. OPERATION

WARNING!

This equipment is intended for use by suitably trained and competent persons.

This product can cause hazards if it is not used in accordance with these instructions. Read them carefully and follow them in all respects. Double check connections to the unit before use.

DO NOT USE THIS EQUIPMENT IF IT IS DAMAGED.

4.1 The Rear Panel

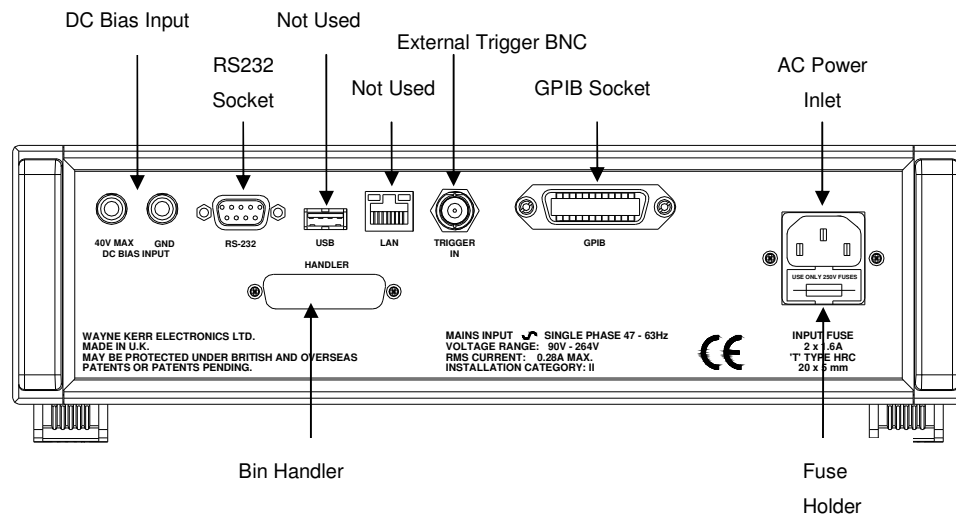

Figure 4-1 The 4300 Rear Panel

4.1.1 AC Power Inlet

The instrument can be operated from an AC power source of either 115V or 230V. It has an auto-ranging power supply circuit which requires no adjustment by the user. A suitable IEC320 C14 power cable (supplied as standard) should be used.

Please read section 1.2 before connecting the AC power.

4.1.2 Fuse Holder

The AC Power inlet includes a Fuse Holder drawer which holds two fuses, as both Live and Neutral lines are fused for protection. The drawer can be opened using a finger once the power cord has been removed from the inlet.

The correct fuse for this instrument is a 20 x 5mm 1.6A 'T' Type HRC

Please read section 1.2 before connecting the AC power.

4.1.3 Rear Panel Control Connections

Label	Type	Use	Reference
DC BIAS INPUT	Two 4mm sockets	To allow an external DC power supply to be connected to the DUT.	Sections 4.1.4 and 4.4.8
RS-232 SOCKET	9-way D-type (female)	For remote operation.	Sections 4.1.9 and 5
USB	USB socket Type A	Not used. For future expansion.	Not applicable
LAN	8P8C (RJ45)	Not used. For future expansion.	Not applicable
TRIGGER IN	BNC	Duplicates action of front panel trigger key.	Section 4.1.7
GPIB	Standard GPIB	For remote operation.	Sections 4.1.8 and 5
HANDLER	25-way D-type (male)	Bin Handler (option)	Section 4.1.10 and 4.4.23

4.1.4 DC Bias Input

The rear panel **DC BIAS INPUT** terminals allow an external DC power supply to be connected to the DUT. See section 4.4.8, paying special attention to the warning in that section.

4.1.5 USB

Not used. For future expansion.

4.1.6 LAN

Not used. For future expansion.

4.1.7 Trigger In

The **TRIGGER IN** BNC socket duplicates the action of the front panel trigger key. The input is TTL compatible and when logic low is equivalent to operating the front panel trigger key. This input is level sensitive and fully debounced, and includes a pull up resistor to enable shorted contacts such as relays or footswitches to be used.

4.1.8 GPIB

The General Purpose Interface Bus (GPIB) is a parallel port which allows communication between the instrument and other devices such as PCs fitted with a suitable interface card. The GPIB port allows remote control of the instrument for measurement of components and the collection of measurement results. For details of GPIB control and commands see section 5.

Devices should be connected to the instrument using a standard GPIB 24-pin connector assembly with a shielded cable. Use of the standard connector consisting of a plug and receptacle is recommended and should be compatible with the Amphenol and Cinch Series 57 or Amp Champ.

4.1.8.1 GPIB Connector Pin Assignment

Pin	Description	Pin	Description
1	Data Line 1	13	Data Line 5
2	Data Line 2	14	Data Line 6
3	Data Line 3	15	Data Line 7
4	Data Line 4	16	Data Line 8
5	EOI (End or Identify)	17	REN (Remote Enable)
6	DAV (Data Valid)	18	Ground
7	NRFD (Not Ready For Data)	19	Ground
8	NDAC (Not Data Accepted)	20	Ground
9	IFC (Interface Clear)	21	Ground
10	SRQ (Service Request)	22	Ground
11	ATN (Attention)	23	Ground
12	Screen	24	Signal Ground

4.1.9 RS-232 Connector

The RS-232 is a serial port designed to be used for communication between instruments and control devices such as PCs fitted with a suitable interface card. The instrument is fitted with a 9 way D type female connector. Note that the connecting cable must link 4300 pin 2 to Control Device pin 3 etc, so straight through 9-way serial cables will not be suitable.

4.1.9.1 Serial Port Connections

Function	4300	Control Device
RxD	Pin 3	Pin 2
TxD	Pin 2	Pin 3
GND	Pin 5	Pin 5
RTS	Pin 8	Pin 7
CTS	Pin 7	Pin 8

4.1.10 Bin Handler

4.1.10.1 B1 version (non-isolated) pin assignment:

Pin	Description	Pin	Description
1	BIN 0 (active low)	14	-
2	BIN 1 (active low)	15	-
3	BIN 2 (active low)	16	-
4	BIN 3 (active low)	17	-
5	\overline{BDA}	18	BIN 9 (active low)
6	-	19	-
7	+5V supply (<50mA)	20	-
8	\overline{TRIG}	21	PASS/FAIL output (low = PASS)
9	-	22	-
10	\overline{BUSY}	23	-
11	-	24	Ground (0V)
12	-	25	-
13	BIN 4 (active low)		

4.1.10.2 B2 VERSION (ISOLATED) PIN ASSIGNMENT:

Pin	Description	Pin	Description
1	BIN 0 (active high)	14	-
2	BIN 1 (active high)	15	-
3	BIN 2 (active high)	16	-
4	BIN 3 (active high)	17	-
5	\overline{BDA}	18	BIN 9 (active high)
6	-	19	-
7	-	20	-
8	Trigger input +ve	21	PASS/FAIL output (high = PASS)
9	Trigger input -ve	22	-
10	\overline{BUSY}	23	-
11	-	24	-
12	-	25	Common +24V input
13	BIN 4 (active high)		

4.2 The Front Panel

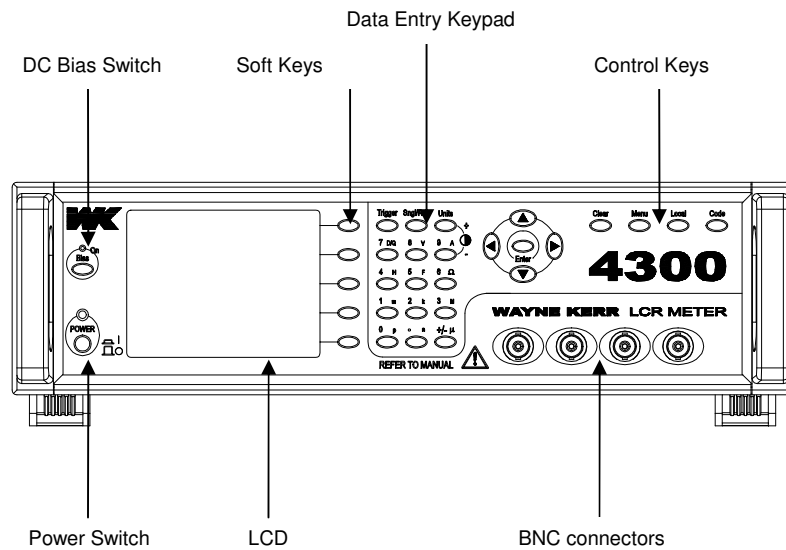

Figure 4-2 The 4300 Front Panel

4.2.1 Switching the Instrument ON

With the instrument connected to the AC power supply (see section 3—Installation) press the **POWER** switch. The power indicator will light and the instrument will display the mode and settings selected when the instrument was last switched off (the exception is **Bias** which, for safety reasons, is always OFF when the instrument is powered up).

4.2.2 Contrast adjustment

The brightness of the Liquid Crystal Display can be adjusted by pressing two keys on the front panel. The **Units** key will increase the brightness and the **9** key will reduce the brightness.

4.2.3 Switching the Instrument OFF

The power can be switched OFF at any time without damage to the instrument, but to avoid losing trim and calibration data, the instrument should be switched OFF when it is in a quiescent state rather than when it is running a routine, e.g. trimming or data entry.

4.2.4 The Soft Keys

The functions of the five soft keys change according to the mode selected. In addition, they are disabled sometimes when various selection pages are being used.

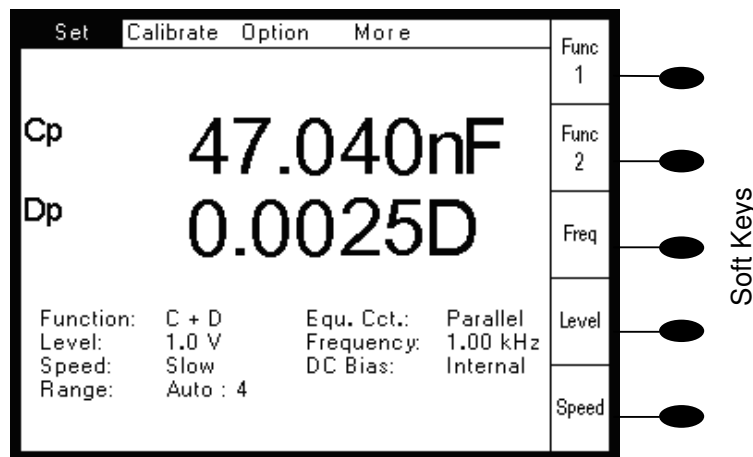

Figure 4-3 The Soft Keys

4.2.5 The Navigation Keys

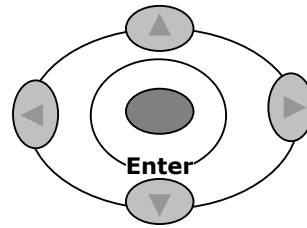

Figure 4-4 The Navigation Keys

When the set up details are showing on the screen, the navigation keys allow each parameter to be selected in turn. **Enter** is used to confirm the selected parameter.

4.2.6 The Control Keys

The following keys, all on the front panel, are used as Control Keys.

Bias

Trigger

Sngl/Rep

Bias toggles the DC bias voltage ON and OFF. The associated LED lights when Bias is ON. Bias is selectable between **Internal** and **External**.

WARNING!

Take care to observe the correct polarity when connecting the DUT to the Kelvin clips or fixture when bias voltage is applied:

For internal bias the DUT +ve must be connected to the fixture Bias terminal or the RED Kelvin clip.

For external bias, +ve or -ve bias may be applied. The bias polarity at the fixture Bias terminal or the RED Kelvin clip will correspond to the bias polarity applied to the rear panel Bias terminals.

Internal bias is available for charging capacitors. Internal Bias supplies a preset 2V DC level via a rapid charge circuit. When Bias is switched ON, a **Charging...** message is shown on the screen. When the message disappears, the bias level has stabilized. When Bias is switched OFF, a **Discharging...** message is shown on the screen. When the message disappears, the bias level has stabilized at 0V.

External bias allows an external DC power supply to be connected to the DUT via the Bias terminals on the rear panel. If an accurate bias voltage is required, a DC voltmeter can be connected between the RED Kelvin clip and ground (the crocodile clip). If using a 1EV1006 fixture, the DC voltmeter can be connected between the Bias terminal and the bar along which the jaws slide. The bias voltage is routed via the ORANGE BNC connector. Take care that the AC test voltage (V_{ac}) present on the test leads does not affect the DC voltmeter accuracy. If necessary, temporarily set V_{ac} to a low value.

Sngl/Rep toggles between **Single shot mode** and **Repetitive mode**. Single shot mode is indicated by the lack of a continuously flashing diamond (◊) in the top right corner of the screen. Conversely, the presence of a continuously flashing diamond indicates that the instrument is in repetitive mode. The asterisk flashes once every time the instrument makes a measurement. **Repeat Trigger** cannot be used when **External Control** is set to GPIB or RS-232.

When in single shot mode, the **Trigger** key initiates a single measurement.

Pressing **Local** restores control to the front panel when the instrument is under GPIB or RS-232 control.

4.2.7 The Data Entry Keypad

The data-entry keypad is a multi-function key set permitting manual entry of data values, measurement units and control codes.

Terminate with **Enter** to accept the key sequence.

4.3 Trimming

The purpose of trimming is to eliminate the effects of stray capacitance or series impedance in the connecting leads or fixture.

The trim values are held in non-volatile stores and for most measurements no retrimming is necessary. The exceptions are when the lead set or fixture is changed or when the highest possible accuracy is required for measurements of very high or very low impedances.

The instrument trims by making measurements at a number of frequencies and storing the corrections for each. If the measurement frequency is changed the instrument automatically applies a new correction value by interpolation of the stored values. Corrections for the Rdc functions are also stored.

For **O/C Trim** the Kelvin clips or fixture jaws should be separated by a distance equivalent to the DUT pin separation.

For **S/C Trim** the connector jaws should be clipped to a piece of wire or a component lead as close together as possible. Do not connect the clips directly together: this does not provide the necessary 4-terminal short circuit and will lead to trim errors.

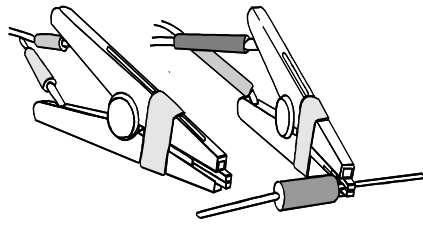

Figure 4-5 Connections for O/C trimming of Kelvin clips

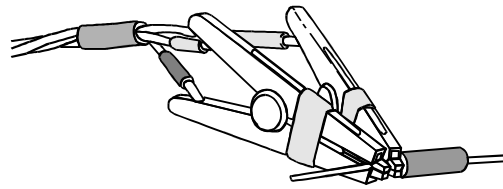

Figure 4-6 Connections for S/C trimming of Kelvin clips

4.3.1 Performing an Open Circuit Trim and Short Circuit Trim

The **Calibrate** Pull Down Menu allows O/C Trim and S/C Trim routines to be run.

To select the **Calibrate** Pull Down Menu, use the **Left** or **Right** Navigation Keys to highlight **Calibrate**, and then press **Enter**. If necessary, press the **Menu** key to activate the top row choices. The following screen will be displayed:

Set	Calibrate	Option	More	Func
	O/C Trim			1
	S/C Trim			2
Cp	47.040nF			Func
Dp	0.0025D			2
				Freq
Function:	C + D	Equ. Cct.:	Parallel	Level
Level:	1.0 V	Frequency:	1.00 kHz	
Speed:	Slow	DC Bias:	Internal	
Range:	Auto : 4			Speed

Figure 4-7 Calibrate Pull Down Menu

Select **O/C Trim** using the Navigation Keys and then press **Enter**. The following screen will be displayed:

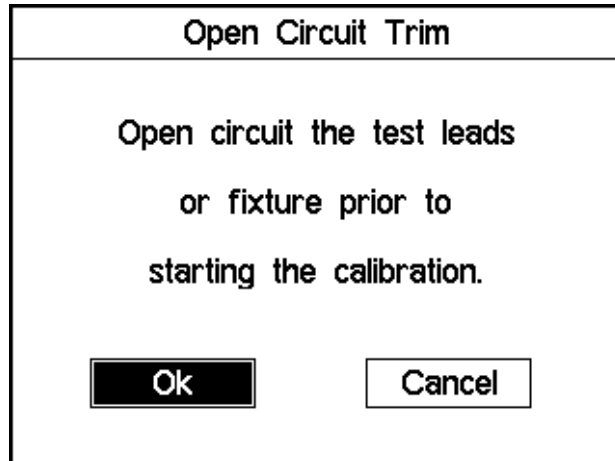

Figure 4-8 Open Circuit Trim Page

- 1) Open-circuit the Kelvin clips (see Fig 4-5), and press **Enter**. If required, use the Navigation Keys to select **Cancel** and then press **Enter**.
- 2) The instrument will display the following message while the open-circuit trim routine is being performed:

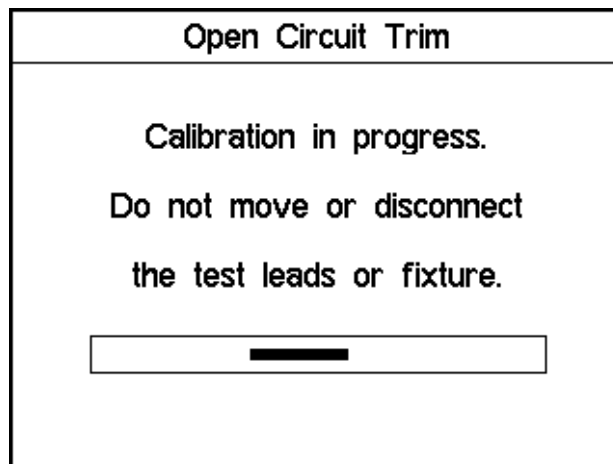

Figure 4-9 Open Circuit Trim in progress

- 3) When the O/C trim has been completed, the instrument will return to its original screen.
- 4) Select **O/C Trim** using the Navigation Keys and then press **Enter**. The following screen will be displayed:

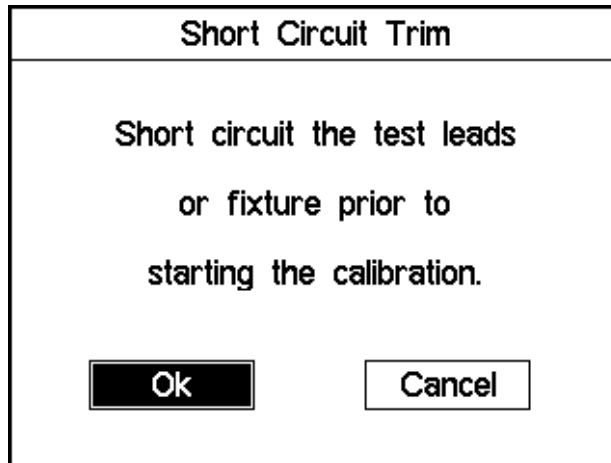

Figure 4-10 Short Circuit Trim Page

- 5) Short-circuit the Kelvin clips (see Fig 4-6) and press **Enter**. If required, use the Navigation Keys to select **Cancel** and then press **Enter**.
- 6) The instrument will display the following message while the short-circuit trim routine is being performed:

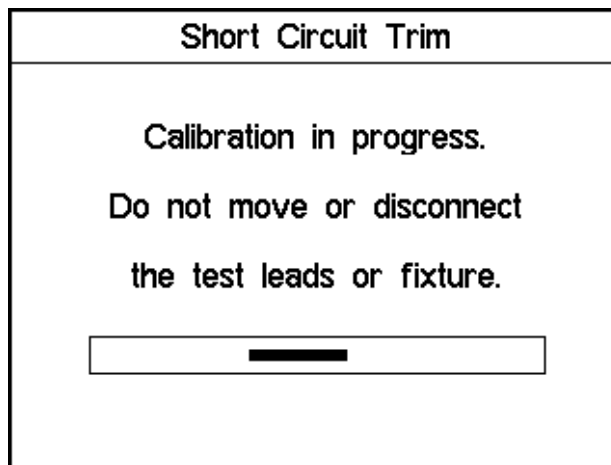

Figure 4-11 Short Circuit Trim in progress

- 7) When the S/C trim has been completed, the instrument will return to the last measurement screen.

4.4 Measurement

The instrument should be powered up with the test leads or fixture connected to the front panel BNC connectors. If the test leads or fixture have been changed since the instrument was last used, the instrument should be trimmed as described in section 4.3.

4.4.1 Main Menu

To select the Main Menu page, press the **Menu** key. The following screen will be displayed:

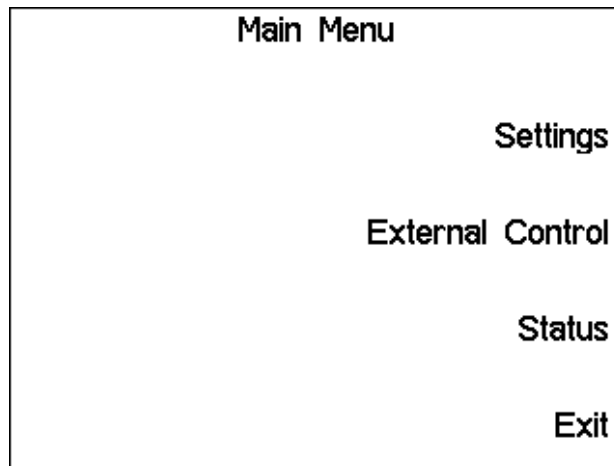

Figure 4-12 Main Menu Page

The **Settings**, **External Control** and **Status** Pages can be selected by pressing the appropriate Soft Key. Press **Exit** to return the display to the Measurement Screen.

4.4.2 Settings Page

The following screen will be displayed when **Settings** has been selected in the **Main Menu** page:

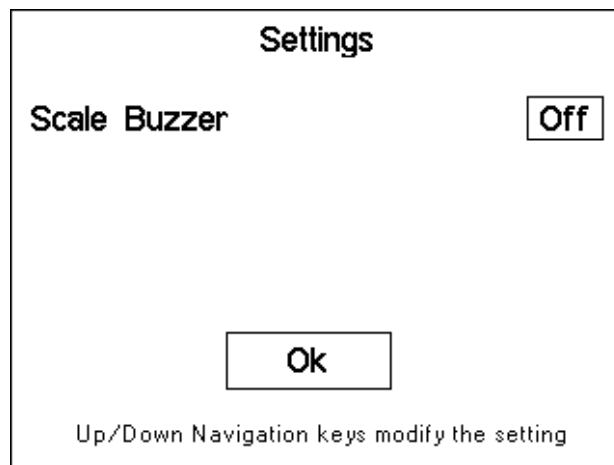

Figure 4-13 Main Menu Page

The Scale Buzzer is used to provide an audio indication when a measurement falls outside one of the limits set when using the bar graphs – see 4.4.17 Scale. The instrument will beep three times when a fail condition occurs.

The Scale Buzzer can be toggled from **Off** to **On** using the **Up** Navigation Keys, and from **On** to **Off** using the **Down** Navigation Key.

Press **Enter** to return to the **Main Menu** page.

4.4.3 Status Page

A screen similar to the example below will be displayed when **Status** has been selected in the **Main Menu** page:

Status	
Instrument Model	43100
Frequency Range	20Hz-1MHz
DC Resistance	Fitted
Bin Handler	Fitted
Ext. Control	GPIB, RS232
User Interface Firmware	2.0.0
Measurement Firmware	2.0.3
Main Board Issue	E1

Figure 4-14 Status Page example

This page will be shown for 5 seconds, and then the display will automatically return to the **Main Menu** page.

4.4.4 External Control Page

The following screen will be displayed when **External Control** has been selected in the **Main Menu** page:

External Control	
GPIB Primary Address	<input type="text" value="6"/>
<input type="button" value="Ok"/>	
Up/Down Navigation keys modify the setting	

Figure 4-15 External Control Page

The GPIB address can be changed by using the **Up** and **Down** Navigation Keys until the required address is shown. Press **Enter** to confirm the new address and return to the **Main Menu** page.

4.4.5 Measurement Screen

A typical measurement screen is shown below:

Set	Calibrate	Option	More	Func 1
Cp	47.040nF			Func 2
Dp	0.0025D			Freq
Function:	C + D	Equ. Cct.:	Parallel	Level
Level:	1.0 V	Frequency:	1.00 kHz	Speed
Speed:	Slow	DC Bias:	Internal	
Range:	Auto : 4			

Figure 4-16 Typical Measurement Screen

The features described below are all available from this Measurement Screen.

4.4.6 Set Pull Down Menu

The **Set** Pull Down Menu allows all measurement parameters to be selected and configured. In addition, Function1, Function 2, Frequency, AC Level and Speed can also be selected in a single keystroke using the soft keys.

To select the **Set** Pull Down Menu, use the **Left** or **Right** navigation keys to highlight **Set**, and then press **Enter**. If necessary, press the **Menu** key to activate the top row. The following screen will be displayed:

Set	Calibrate	Option	Mode	Func 1
Function 1	47.040nF			Func 2
Function 2				0.0025D
Equ. Cct.				
Frequency				
Drive Level				
Speed				
DC Bias				
Range				
Function:	C + D	Equ. Cct.:	Parallel	
Level:	1.0 V	Frequency:	1.00 kHz	
Speed:	Slow	DC Bias:	Internal	
Range:	Auto : 4			

Figure 4-17 Set Pull Down Menu and Soft Keys

The following features can be selected from the **Set** Pull Down Menu:

Function 1 This allows any one of the following 11 AC measurement parameters to be selected.

- C Capacitance
- L Inductance
- X Reactance
- B Susceptance
- Z Impedance
- Y Admittance
- Q Quality Factor
- D Dissipation Factor (tan delta)
- R AC Resistance
- G Conductance
- A Phase Angle

It also allows Rdc (DC resistance) to be selected when this option is fitted.

Function 1 can also be selected using the Soft Key labeled **Func 1**.

Function 2 This allows any of the 11 AC measurement parameters offered in **Function 1** to be selected (but not Rdc).

Function 2 can also be selected using the Soft Key labeled **Func 2**.

Equ. Cct. This allows the Equivalent Circuit used to calculate the AC measurements to be toggled between **Series** and **Parallel**

Frequency This allows the AC measurement frequency to be set between 20Hz and

- 100kHz for 4310
- 200kHz for 4320
- 500kHz for 4350
- 1MHz for 43100

Frequency can also be selected using the Soft Key labeled **Freq.**

Drive Level This allows the AC Drive Level to be selected between 10mVrms and 2Vrms.

Drive Level can also be selected using the Soft Key labeled **Level**.

Speed	This allows the measurement speed to be selected from the following choices: Maximum Fast Medium Slow Speed can also be selected using the Soft Key labeled Speed .
DC Bias	This allows a DC Bias Voltage to be applied to the Device Under Test. The DC Bias can be either 2V (internal) or $\pm 40V$ when supplied from an external DC power supply.
Range	This allows the measurement hardware range used by the instrument to be set to either Auto or a fixed range.

4.4.7 Function 1

When **Function 1** has been selected from the **Set** Pull Down Menu (or using the **Func 1** Soft Key), the following page will be displayed:

Set	Calibrate	Option	Mode	Func 1
Cp	47.040nF			Func 2
Dp	0.0025D			Freq
Function:	C + D	Equ. Cct.:	Parallel	Level
Level:	1.0 V	Frequency:	1.00 kHz	Speed
Speed:	Slow	DC Bias:	Internal	
Range:	Auto : 4			
Function 1: C L X B Z Y Q D R G A Rdc				

Figure 4-18 Function 1 Selection Page

The required measurement parameter should be selected by using the Navigation Keys to highlight the appropriate letter, and then press **Enter**.

The selected parameter will then be displayed using the appropriate letter, followed by either **p** or **s** depending on whether the **Equivalent Circuit** has been set to **Parallel** or **Series**.

Rdc will only be displayed when this option has been fitted to the instrument.

4.4.8 Function 2

When **Function 2** has been selected from the **Set Pull Down Menu** (or using the **Func 2 Soft Key**), the following page will be displayed:

Set	Calibrate	Option	Mode	
				Func 1
Cp	47.040nF			Func 2
Dp	0.0025D			Freq
Function:	C + D	Equ. Cct.:	Parallel	Level
Level:	1.0 V	Frequency:	1.00 kHz	Speed
Speed:	Slow	DC Bias:	Internal	
Range:	Auto : 4			
Function 2: C L X B Z Y Q D R G A				

Figure 4-19 Function 2 Selection Page

The required measurement parameter should be selected by using the Navigation Keys to highlight the appropriate letter, and then press **Enter**.

The selected parameter will then be displayed using the appropriate letter, followed by either **p** or **s** depending on whether the **Equivalent Circuit** has been set to **Parallel** or **Series**.

4.4.9 Equivalent Circuit

When **Equ. Cct.** has been selected from the **Set Pull Down Menu**, the following page will be displayed:

Set	Calibrate	Option	Mode	
				Range
Cp	47.040nF			Func 2
Dp	0.0025D			Freq
Function:	C + D	Equ. Cct.:	Parallel	Level
Level:	1.0 V	Frequency:	1.00 kHz	Speed
Speed:	Slow	DC Bias:	Internal	
Range:	Auto : 4			
Equ. Cct.: Parallel Series				

Figure 4-20 Equivalent Circuit Selection Page

The required Equivalent Circuit should be selected by using the Navigation Keys to highlight the appropriate setting, and then press **Enter**.

When **Parallel** has been selected, the **Function 1** and **Function 2** letters will be followed by the letter **p**. When **Series** has been selected, the letters will be followed by the letter **s**.

4.4.10 Frequency

When **Frequency** has been selected from the **Set** Pull Down Menu (or using the **Freq** Soft Key), the following page will be displayed:

Set	Calibrate	Option	Mode	
				Func 1
Cp	47.040nF			Func 2
Dp	0.0025D			Freq
Function:	C + D	Equ. Cct.:	Parallel	Level
Level:	1.0 V	Frequency:	1.00 kHz	
Speed:	Slow	DC Bias:	Internal	
Range:	Auto : 4			Speed
Frequency: 1.00 kHz				

Figure 4-21 Frequency Setting Page 1st stage

When the first digit of the required frequency has been keyed in, the soft keys will change, as shown below, to allow the required frequency units to be selected with a single keystroke.

Set	Calibrate	Option	Mode	
Cp	47.040nF			
Dp	0.0025D			MHz
Function:	C + D	Equ. Cct.:	Parallel	kHz
Level:	1.0 V	Frequency:	1.00 kHz	
Speed:	Slow	DC Bias:	Internal	
Range:	Auto : 4			Hz
Frequency: 1.0				

Figure 4-22 Frequency Setting Page 2nd stage

Pressing the soft key will also terminate the data entry and return the instrument to the measurement screen.

4.4.11 AC Drive Level

When **Drive Level** has been selected from the **Set Pull Down Menu** (or using the **Level Soft Key**), the following page will be displayed:

Set	Calibrate	Option	Mode	
				Func 1
Cp	47.040nF			Func 2
Dp	0.0025D			Freq
Function:	C + D	Equ. Cct.:	Parallel	Level
Level:	1.0 V	Frequency:	1.00 kHz	
Speed:	Slow	DC Bias:	Internal	
Range:	Auto : 4			Speed
Level: 1.0 V				

Figure 4-23 AC Drive Level Setting Page 1st stage

When the first digit of the required level has been keyed in, the soft keys will change, as shown below, to allow the required voltage units to be selected with a single keystroke.

Set	Calibrate	Option	Mode	
Cp	47.040nF			
Dp	0.0025D			
Function:	C + D	Equ. Cct.:	Parallel	V
Level:	1.0 V	Frequency:	1.00 kHz	
Speed:	Slow	DC Bias:	Internal	
Range:	Auto : 4			mV
Level: 0.				

Figure 4-24 AC Drive Level Setting Page 2nd stage

Pressing the soft key will also terminate the data entry and return the instrument to the measurement screen.

4.4.12 Measurement Speed

When **Speed** has been selected from the **Set** Pull Down Menu (or using the **Speed** Soft Key), the following page will be displayed:

Set	Calibrate	Option	Mode	Func 1
Cp	47.040nF			Func 2
Dp	0.0025D			Freq
Function:	C + D	Equ. Cct.:	Parallel	Level
Level:	1.0 V	Frequency:	1.00 kHz	Speed
Speed:	Slow	DC Bias:	Internal	
Range:	Auto : 4	Speed: Maximum Fast Medium Slow		

Figure 4-25 Measurement Speed Selection Page

The required measurement speed should be selected by using the Navigation Keys to highlight the appropriate setting, and then press **Enter**.

4.4.13 DC Bias Voltage

When **DC Bias** has been selected from the **Set** Pull Down Menu, the following page will be displayed:

Set	Calibrate	Option	Mode	Func 1
Cp	47.040nF			Func 2
Dp	0.0025D			Freq
Function:	C + D	Equ. Cct.:	Parallel	Level
Level:	1.0 V	Frequency:	1.00 kHz	Speed
Speed:	Slow	DC Bias:	Internal	
Range:	Auto : 4	DC Bias: Internal External		

Figure 4-26 DC Bias Voltage Selection Page

If the Internal DC Bias Voltage of 2V is required, select **Internal**, and then press **Enter**.

If the External DC Bias Voltage supplied via the rear panel is required, select **External** and then press **Enter**.

The Bias Voltage is then applied by pressing the **Bias** button – see section 4.2.6.

4.4.14 Range

When **Range** has been selected from the **Set** Pull Down Menu, the following page will be displayed:

Set	Calibrate	Option	Mode	Func
Cp				1
47.040nF				2
Dp				Freq
0.0025D				Level
Function:	C + D	Equ. Cct.:	Parallel	Speed
Level:	1.0 V	Frequency:	1.00 kHz	
Speed:	Slow	DC Bias:	Internal	
Range:	Auto : 4			
Range: Auto 1 2 3 4 5 6 7				

Figure 4-27 Hardware Range Selection Page

The required range setting should be selected by using the Navigation Keys to highlight the appropriate setting, and then press **Enter**.

The display will then show the user selected range setting, followed by the range used to make the last measurement. In the example above, the user has selected **Auto** and the last measurement was made using Range 4.

Auto range automatically selects the most accurate range for the measurement.

4.4.15 DC Resistance

When **Rdc** has been selected from the **Function 1** Selection Page, the following page will be displayed:

Set	Calibrate	Option	Mode	Func
Rdc				Level
10.003kΩ				Speed
Function: Rdc				Range
Level: 1.0 V				
Speed: Slow				
Range: Auto : 5				

Figure 4-28 Rdc Measurement Screen

When the DC Resistance **Set** Pull Down Menu is then selected, the following page will be displayed:

Set	Calibrate	Option	Mode	
Function				Func
Drive Level				Level
Speed				Speed
Range				Range
10.003kΩ				
Function: Rdc				
Level: 1.0 V				
Speed: Slow				
Range: Auto : 5				

Figure 4-29 DC Resistance Selection Page

Function will select the **Function 1** Selection Page detailed in section 4.4.7.

Drive Level will allow either 1Vdc or 2Vdc to be selected.

Speed will select the **Speed** Selection Page detailed in section 4.4.12

Range will select the **Range** Selection Page detailed in section 4.4.14.

4.4.16 Option Pull Down Menu

The **Option** Pull Down Menu allows the following features to be configured:

Scale

External Control (RS-232 or GPIB)

Buzzer

To select the **Option** Pull Down Menu, use the **Left** or **Right** navigation keys to highlight **Option**, and then press **Enter**. The following screen will be displayed

Set	Calibrate	Option	Mode	
		Scale		Func 1
		Ext Control		Func 2
		Buzzer		Freq
Cp	47.040nF			Level
Dp	0.0025D			Speed
Function:	C + D	Equ. Cct.:	Parallel	
Level:	1.0 V	Frequency:	1.00 kHz	
Speed:	Slow	DC Bias:	Internal	
Range:	Auto : 4			

Figure 4-30 Option Pull Down Menu

Use the **Up** or **Down** navigation keys to highlight the required feature, and then press **Enter**.

4.4.17 Scale

Bar graphs for Functions 1 & 2 can be used to graphically show if a measurement is within limits set by the user.

When **Scale** is selected, the following screen is shown:

Set	Calibrate	Option	Mode	
				Term
Cp	<input type="text"/> <input type="text"/>			Abs Perc
	00.00nF	00.00nF		
Dp	<input type="text"/> <input type="text"/>			High Limit
	0.000D	0.000D		
Function:	C + D	Equ. Cct.:	Parallel	Low Limit
Level:	1.0 V	Frequency:	1.00 kHz	
Speed:	Slow	DC Bias:	Internal	
Range:	Auto : 4			

Figure 4-31 Scale Initial Page

The **Term** Soft Key will toggle between Function 1 and Function 2 to enable the limits to be set for the active Function. The active Function is shown in a rectangle (Cp in the figure above).

The **Abs/Perc** Soft Key toggles the limits between Percentage values relative to a user-selected nominal value and Absolute values.

The **High Limit** Soft Key allows the upper limit for the active Function to be entered by the user. When the first digit has been keyed in, the Soft Keys will change to allow valid units to be selected (for example $\mu\Omega$, m Ω , k Ω and M Ω when the active Function is Z).

The **Low Limit** Soft Key allows the lower limit for the active Function to be entered by the user.

When the **Percentage** option has been selected, a fifth Soft Key, **Nom**, will appear. This allows the Nominal value, relative to which the percentages are calculated, to be entered.

The measurement conditions should be set up as normal using the **Set Pull Down Menu**. Measurements are then triggered as normal using the **Trigger** key and **Sngl/Rep** keys.

The measurements for Functions 1 & 2 are each plotted on a bar graph. The figure below explains the bar graphs:

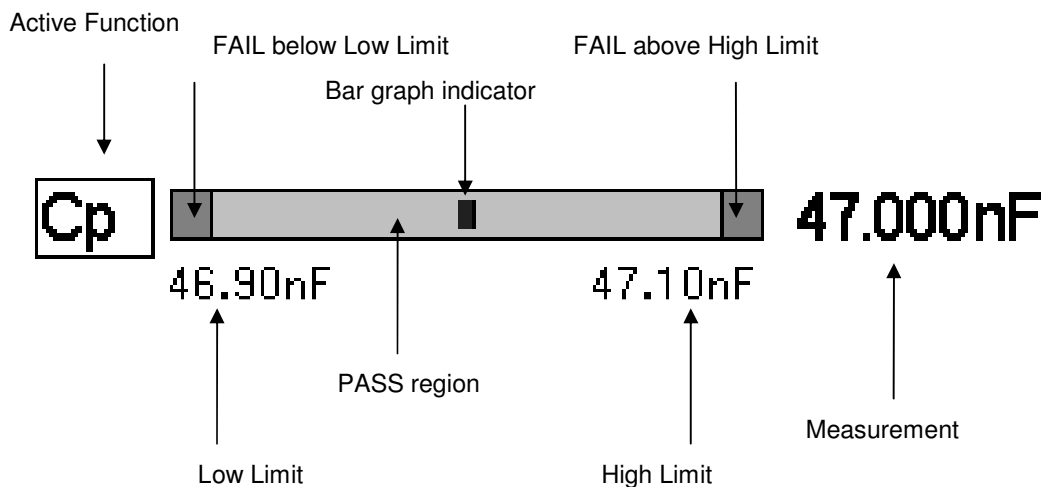

Figure 4-32 Bar Graph explanation

When the measurement is inside the PASS region, bar graph indicator position will be proportional to the Low and High Limits.

When the measurement is outside the PASS region, the indicator will be in the appropriate FAIL region and the measurement will be in reversed contrast.

4.4.18 External Control

When **External Control** is selected, the following screen will be displayed:

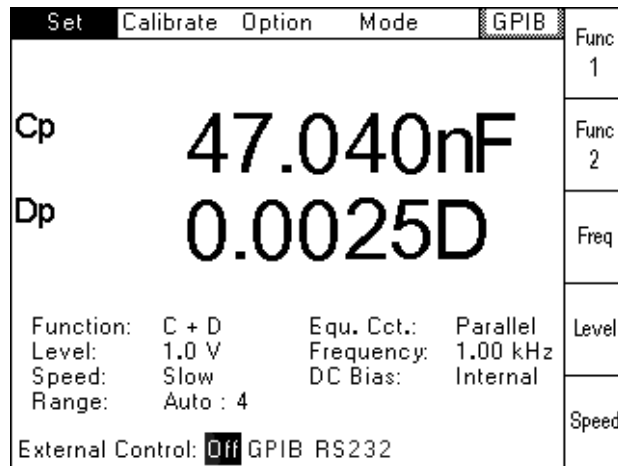

Figure 4-33 External Control Selection Screen

Off will disable any remote control and return the unit to **Local Mode**.

GPIB will allow the unit to be controlled using GPIB.

RS232 will allow the instrument to be controlled using RS232.

The active mode (GPIB in this example) will also be displayed in the top right corner of the screen.

Repeat Trigger cannot be used when **External Control** is set to GPIB or RS232.

4.4.19 Buzzer

When **Buzzer** is selected, the internal buzzer will be enabled and sound for every keystroke. When **Buzzer** is selected again, this feature will be disabled.

4.4.20 More Pull Down Menu

The **More** Pull Down Menu allows the following features to be accessed:

Recall

Save

Binning (when this option is fitted)

To select the **More** Pull Down Menu, use the **Left** or **Right** navigation keys to highlight **More**, and then press **Enter**. The following screen will be displayed (Binning only shown when fitted):

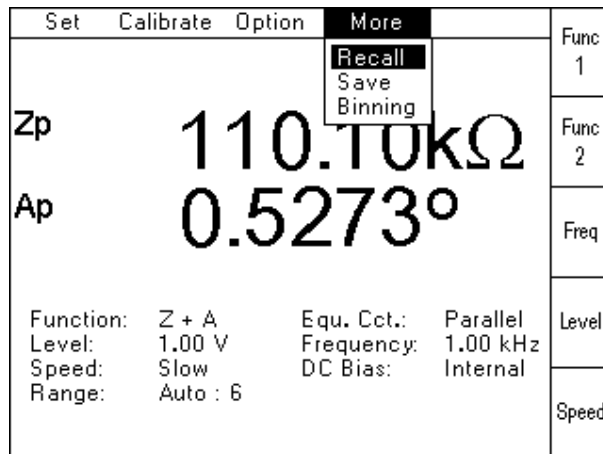

Figure 4-34 More Pull Down Menu

Use the **Up** or **Down** navigation keys to highlight the required feature, and then press **Enter**.

4.4.21 Recall

Recall allows a previously stored measurement setup (see **Save** below) to be recalled and used. When **Recall** is selected, the following screen will be displayed:

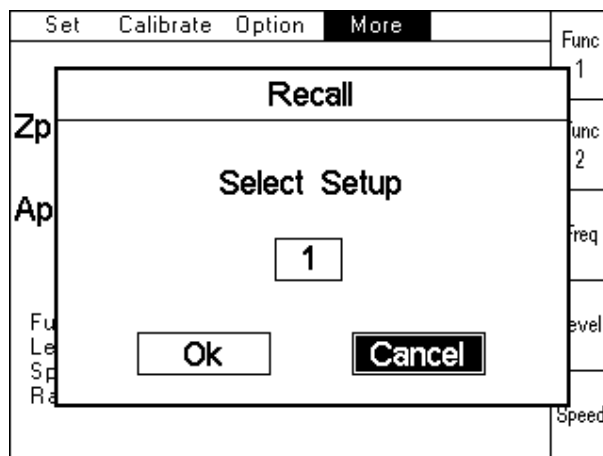

Figure 4-35 Recall Screen

Use the **Up** and **Down** arrows to scroll through the memory location numbers. Only memory locations which have setups stored in them will be displayed. When the desired memory location is shown, use the **Left** and **Right** arrows to highlight **OK** and then press **Enter** to recall the setup.

A message reading “Instrument Setup: x”, where x is the memory location number, will be displayed at the bottom of the screen. This will disappear when the measurement setup is altered in any way.

4.4.22 Save

Save allows the current measurement setup to be saved to one of 20 memory locations within the 4300. When **Save** is selected, the following screen will be displayed:

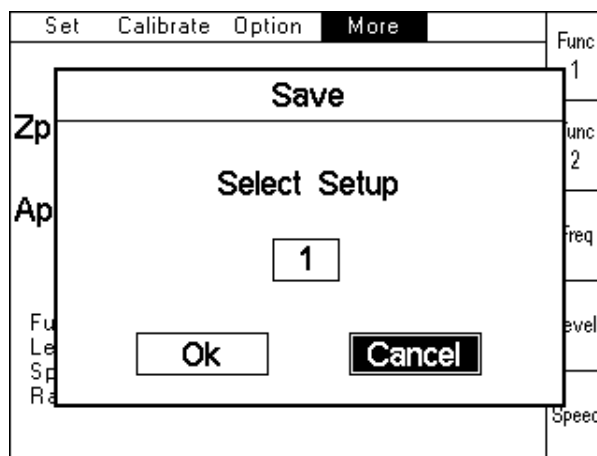

Figure 4-36 Save Screen

Use the **Up** and **Down** arrows to scroll through all the memory location numbers, including ones which already have setups stored in them. When the desired memory location is displayed, use the **Left** and **Right** arrow to highlight **OK** and then press **Enter**. The instrument will save the setup to memory.

A message reading “Instrument Setup: x”, where x is the memory location number, will be displayed at the bottom of the screen. This will disappear when the measurement setup is altered in any way.

4.4.23 Binning (option)

There are 3 different elements to the 4300 Binning function: **Set**, **Sort** and **Count**.

Set is used to define the Bin Type and set the limits. This must be done before any binning can be performed.

Sort is used to make the measurements after which the instrument selects the appropriate bin based on the results.

Count is used to show the total number of items allocated to each bin since the counters were last reset to 0.

Chapter 6 contains a full explanation of the Binning function and examples.

Bins 0 – 2 (One Term) and Bins 0 – 4 (One Term Dual Limits and Two Term) are used when valid measurements are made. When measurement produces an O/R (Out of Range) result, the component will be sorted to Bin 9 (for all three Bin Types). Setting the **Range** to Auto (see 4.4.14) will minimise the possibility of this happening.

To access **Set, Sort, Count** and (Binning) **Off**, select **Binning** from the **More** Pull Down Menu. The following screen will be displayed:

Set	Calibrate	Option	More	Func 1
Zp	110.10kΩ			Func 2
Ap	0.5244°			Freq
Function:	Z + A	Equ. Cct.:	Parallel	Level
Level:	1.00 V	Frequency:	1.00 kHz	Speed
Speed:	Slow	DC Bias:	Internal	
Range:	Auto : 6			
Binning Mode: Off Set Sort Count				

Figure 4-37 Binning Mode screen

Off, Set, Sort and **Count** can be selected by using the **Left** and **Right** arrows until the required section is highlighted. Press **Enter** to confirm the selection.

4.4.24 Binning – Set

This section is used to define the Binning Type and limits used to sort. It is accessed in two steps:

1. Set the **Bin Mode** to **Set** as detailed in section 4.4.23 (Binning Overview).
2. Select **Bin Types** from the **Option** pull-down menu, as shown below:

Set	Calibrate	Option	More	Abs Perc
Zp	LL1	Bin Types Ext Control Buzzer		High Limit
	99.00kΩ		---	101.0kΩ
One Term – Count Disabled				
Function:	Z + A	Equ. Cct.:	Parallel	
Level:	1.00 V	Frequency:	1.00 kHz	
Speed:	Slow	DC Bias:	Internal	
Range:	Auto			

Figure 4-38 Bin Types screen

Press **Enter** to confirm. This will cause the last used Binning Type and limits to be displayed.

The three Binning Types available are:

One Term

One Term Dual Limits

Two Term.

These are fully explained in Chapter 6, including the definitions of LL1, LL2, HL1 and HL2. Any of these Bin Types can be selected by using the **Left** and **Right** arrows.

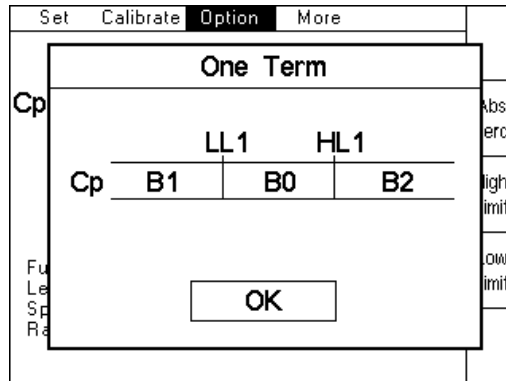

Figure 4-39 One Term selection screen

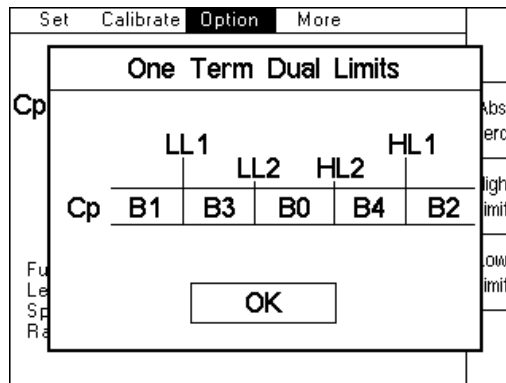

Figure 4-40 One Term Dual Limits selection screen

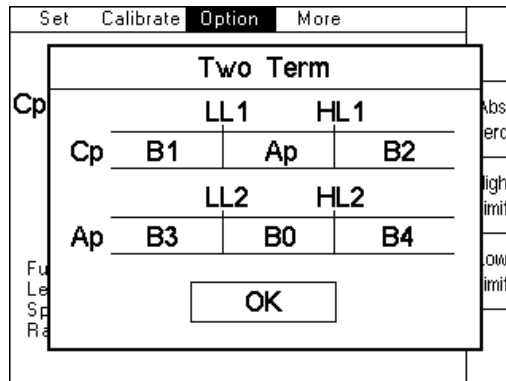

Figure 4-41 Two Term selection screen

Press **Enter** to confirm the selection.

The measurement conditions (such as frequency and level) should be set up in the normal way using the **Set** pull-down menu.

It is possible to make measurements in Set Mode by pressing the **Trigger** key. The measurement and resultant bin number will be displayed on the screen. This must be done if the **Save Res(ult)** feature is going to be used when setting percentage limits.

The measurements displayed on the screen will be truncated and rounded versions of the actual measurements made by the instrument. The actual measurements are used to sort into bins. This can produce a situation where a repeat of the same displayed measurement appears to give different bins.

The **Count** feature is disabled in **Set** mode, and a message is shown on the screen next to the Bin Type.

4.4.24.1 Binning – Setting One Term Limits

One of two screens will be displayed when the **One Term** Binning Type has been selected, depending on whether the last limits used were **Absolute** or **Percentage**:

Set	Calibrate	Option	More	
Zp	LL1	Nom	HL1	Abs
				Perc
	99.00kΩ	---	101.0kΩ	High Limit
One Term - Count Disabled				
Function:	Z + A	Equ. Cct.:	Parallel	Low Limit
Level:	1.00 V	Frequency:	1.00 kHz	
Speed:	Slow	DC Bias:	Internal	
Range:	Auto			

Figure 4-42 One Term Absolute limits screen

Set	Calibrate	Option	More	
Zp	LL1	Nom	HL1	Abs
				Perc
	-5.0%	100.1kΩ	5.0%	High Limit
One Term - Count Disabled				
Function:	Z + A	Equ. Cct.:	Parallel	Low Limit
Level:	1.00 V	Frequency:	1.00 kHz	
Speed:	Slow	DC Bias:	Internal	
Range:	Auto : 6			Nom

Figure 4-43 One Term Percentage Limits screen

The **Abs/Perc** soft key (Absolute/Percentage) is used to toggle between setting the limits as either Absolute limits or Percentage limits.

The **High Limit** soft key is used to enter the HL1 limit. After pressing the **High Limit** soft key, enter the required value using the numerical key pad. After entering the first digit for Absolute Limits, the soft keys will change and offer a variety of multiplier units (as a short cut) for the parameter being set. For example, when Term1 is C(apacitance), the soft keys will display pF, nF, uF and mF. Alternative the full numerical value can be entered and then confirmed by pressing the **Enter** key.

For example, a limit of 1µF can be entered as either **1 uF** or **0 . 0 0 0 0 1 Enter**.

The **Low Limit** soft key is used to enter the LL1 limit. This are set in the same way as the **High Limits** described above.

The **Nom** (Nominal) soft key is only displayed when the **Abs/Perc** soft key is toggled to **Perc**. It is used to enter the nominal value which the percentage limits are calculated from. After pressing the **Nom** soft key, the nominal value can be entered in the same way as **High Limits** and **Low Limits**. It is also possible to save the last measurement as the Nominal Value. This can be done by pressing the **Save Res(ult)** soft key which appears after pressing the **Nom** soft key. When absolute limits are selected, the word “Nom” is still shown on the screen, but is not used.

Set	Calibrate	Option	More	Save Res
Zp	LL1 -5.0%	Nom 100.1kΩ	HL1 5.0%	100.10kΩ Bin 0
One Term - Count Disabled				
Function:	Z + A	Equ. Cct.:	Parallel	
Level:	1.00 V	Frequency:	1.00 kHz	
Speed:	Slow	DC Bias:	Internal	
Range:	Auto			
Nominal:				

Figure 4-44 One Term Save Result screen

When the limits have been set, measurements and binning can be started from either the **Sort** or **Count** screens.

4.4.24.2 Binning – Setting One Term Dual Limits

One of two screens will be displayed when the **One Term Dual Limits** Binning Type has been selected, depending on whether the last limits used were **Absolute** or **Percentage**:

Set	Calibrate	Option	More	Limits 1/2
Zp	LL1	Nom	HL1	Abs
	95.00k Ω	---	105.0k Ω	Perc
L2	LL2	HL2		High Limit
	99.00k Ω	101.0k Ω		
One Term Dual Limits - Count Disabled				
Function:	Z + A	Equ. Cct.:	Parallel	Low Limit
Level:	1.00 V	Frequency:	1.00 kHz	
Speed:	Slow	DC Bias:	Internal	
Range:	Auto			

Figure 4-45 One Term Dual Limits Absolute limits screen

Set	Calibrate	Option	More	Limits 1/2
Zp	LL1	Nom	HL1	Abs
	-1.0%	110.1k Ω	1.0%	Perc
L1	LL2	HL2		High Limit
	-0.5%	0.5%		
One Term Dual Limits - Count Disabled				
Function:	Z + A	Equ. Cct.:	Parallel	Low Limit
Level:	1.00 V	Frequency:	1.00 kHz	
Speed:	Slow	DC Bias:	Internal	
Range:	Auto			Nom

Figure 4-46 One Term Dual Limits Percentage Limits screen

The **Limits 1/2** soft key is used to toggle between LL1/HL1 and LL2/HL2 limits in order to set them. LL1 and HL1 can be set when L1 is shown in the box on the left side of the screen, and LL2 and HL2 can be set when L2 is shown in the box.

The **Abs/Perc** soft key (Absolute/Percentage) is used to toggle between setting the limits as either Absolute limits or Percentage limits.

The **High Limit** soft key is used to enter HL1 and HL2 limits. After pressing the **High Limit** soft key, enter the required value using the numerical key pad. After entering the first digit for Absolute Limits, the soft keys will change and offer a variety of multiplier units (as a short cut) for the parameter being set. For example, when the active Term is C(apacitance), the soft keys will display pF, nF, uF and mF. Alternative the full numerical value can be entered and then confirmed by pressing the **Enter** key.

For example, a limit of 1 μ F can be entered as either **1 uF** or **0 . 0 0 0 0 1 Enter**.

The **Low Limit** soft key is used to enter LL1 and LL2 limits. These are set in the same way as the **High Limits** described above.

The **Nom**(inal) soft key is only displayed when the **Abs/Perc** soft key is toggled to **Perc**. It is used to enter the nominal value which the percentage limits are calculated from. After pressing the **Nom** soft key, the nominal value can be entered in the same way as **High Limits** and **Low Limits**. It is also possible to save the last measurement as the Nominal Value. This can be done by pressing the **Save Res**(ult) soft key which appears after pressing the **Nom** soft key. When absolute limits are selected, the word “Nom” is still shown on the screen, but is not used.

Set				Calibrate	Option	More	Save Res
Zp	LL1	Nom	HL1				
	-1.0%	110.1kΩ	1.0%				
L1	LL2	HL2					
	-0.5%	0.5%					
One Term Dual Limits - Count Disabled							
Function:	Z + A	Equ. Cct.:	Parallel				
Level:	1.00 V	Frequency:	1.00 kHz				
Speed:	Slow	DC Bias:	Internal				
Range:	Auto						
Nominal:							

Figure 4-47 One Term Dual Limits Save Result screen

When the limits have been set, measurements and binning can be started from either the **Sort** or **Count** screens.

4.4.24.3 Binning – Setting Two Term Limits

One of the following two screens will be displayed when the **Two Term** Binning Type has been selected, depending on whether the last limits used were **Absolute** or **Percentage**.

Set				Calibrate	Option	More	Term Abs Perc High Limit Low Limit
Cp	LL1	Nom	HL1				
	1.400nF	---	1.600nF				
Dp	LL2	Nom	HL2				
	0.0000D	---	0.0010D				
Two Term - Count Disabled							
Function:	C + D	Equ. Cct.:	Parallel				
Level:	1.00 V	Frequency:	1.00 kHz				
Speed:	Slow	DC Bias:	Internal				
Range:	Auto						

Figure 4-48 Two Term Absolute limits screen

Set	Calibrate	Option	More	
				Term
Cp	LL1	Nom	HL1	Abs
	-5.0%	1.500nF	5.0%	Perc
Dp	LL2	Nom	HL2	High
	-10.0%	0.0009D	10.0%	Limit
Two Term - Count Disabled				
Function:	C + D	Equ. Cct.:	Parallel	Low
Level:	1.00 V	Frequency:	1.00 kHz	Limit
Speed:	Slow	DC Bias:	Internal	
Range:	Auto			Nom

Figure 4-49 Two Term Percentage Limits screen

The **Term** soft key is used to toggle between Term 1 and Term 2 in order to set their limits. LL1 and HL1 can be set when Term 1 is active. LL2 and HL2 can be set when Term 2 is active. The active Term is identified by a box around the parameter.

The **Abs/Perc** soft key (Absolute/Percentage) is used to toggle between setting the limits as either Absolute limits or Percentage limits. For Two Term limits only, it is possible to have one Term as absolute limits and the other Term as percentage.

The **High Limit** soft key is used to enter HL1 and HL2 limits. After pressing the **High Limit** soft key, enter the required value using the numerical key pad. After entering the first digit for Absolute Limits, the soft keys will change and offer a variety of multiplier units (as a short cut) for the parameter being set. For example, when the active Term is C (capacitance), the soft keys will display pF, nF, uF and mF. Alternatively the full numerical value can be entered and then confirmed by pressing the **Enter** key.

For example, a limit of 1 μ F can be entered as either **1 uF** or **0 . 0 0 0 0 1 Enter**.

The **Low Limit** soft key is used to enter LL1 and LL2 limits. These are set in the same way as the **High Limits** described above.

The **Nom** (Nominal) soft key is only displayed when the **Abs/Perc** soft key is toggled to **Perc**. It is used to enter the nominal value which the percentage limits are calculated from. After pressing the **Nom** soft key, the nominal value can be entered in the same way as **High Limits** and **Low Limits**. It is also possible to save the last measurement as the Nominal Value. This can be done by pressing the **Save Res(ult)** soft key which appears after pressing the **Nom** soft key. When absolute limits are selected, the word "Nom" is still shown on the screen, but is not used.

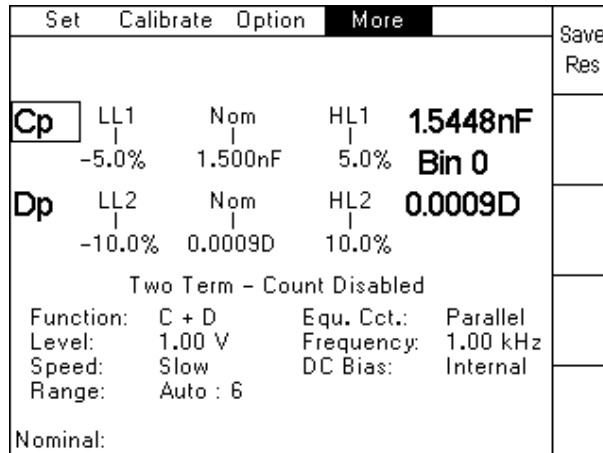

Figure 4-50 Two Term Save Result screen

4.4.25 Binning – Sort

This section is used in order to trigger a measurement and then display the measurement result and appropriate bin (based on the result). It is accessed by selecting **Sort** from the **Binning** screen of the **More** pull down menu (see 4.4.23).

The measurement can be triggered using either the **Trigger** key in the front panel, the remote trigger input on the rear panel or a GPIB trigger command. After the measurement and binning, the screen shows the measurement, resulting bin and total count:

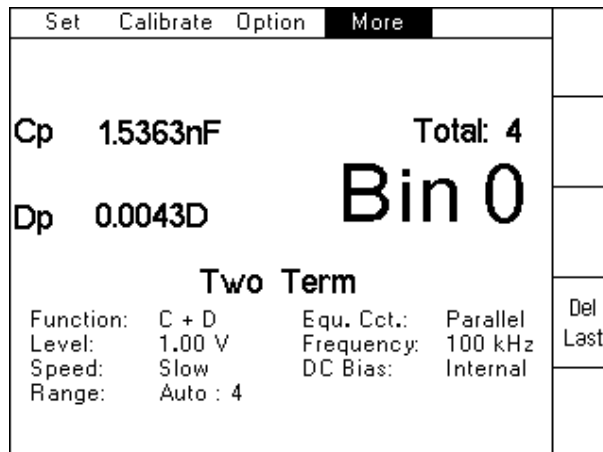

Figure 4-51 Sort screen example

The **Del Last** soft key (Delete Last) can be used to reduce the total count by 1. This can be useful if a known bad measurement (due to a poor connection for example) is made, and it needs to be removed from the counts. This can only be done once after each trigger.

4.4.26 Binning - Count

This section is used to display the results based on the binning performed using the Binning Sort section. It is accessed by selecting **Count** from the **Binning** screen of the **More** pull down menu (see 4.4.23).

The following is an example of a typical screen:

Set	Calibrate	Option	More
Reject: 1 Total: 5			
Bin 0: 4			Del All
Bin 1: 0			
Bin 2: 0			
Bin 3: 0			
Bin 4: 1			
Bin 9: 0			
Two Term			
Function:	C + D	Equ. Cct.:	Parallel
Level:	1.00 V	Frequency:	100 kHz
Speed:	Slow	DC Bias:	Internal
Range:	Auto : 4		
			Del Last

Figure 4-52 Count screen example

The total number of measurements made is shown as Total (5 in this example).

The reject quantity is calculated as follows:

One Term: Reject = Total – BIN 0

One Term Dual Limits: Reject = Total – (BIN 0 + BIN 3 + BIN 4)

Two Term: Reject = Total – BIN 0

The total number of DUT's allocated to each individual bin is also displayed, together with the Binning Type and measurement conditions.

The **Del Last** soft key (Delete Last) can be used to reduce the total count by 1. This can be useful if a known bad measurement (due to a poor connection for example) is made, and it needs to be removed from the counts. This can only be done once after each trigger.

The **Del All** soft key (Delete All) can be used to reset all binning counts to 0. A warning message will ask the user to confirm this reset before it is performed.

5. REMOTE CONTROL (GPIB & RS-232)

5.1 RS-232 Control

5.1.1 Introduction

The RS-232 is a serial port designed to be used for communication between instruments and control devices such as PCs fitted with a suitable interface card.

5.1.2 Protocol

Baud rate: 9600bps
Character length: 8bits
Stop bit: 1bit
Parity: Non-parity
Character: ASCII character

5.1.3 Commands

All the RS-232 commands and functions (with the exception of the SRQ function and the DUMP-BMP command) are the same as the GPIB functions and commands detailed in section 5.2.

Commands are terminated by LF (line feed, ASCII code 10 (decimal)); only the LF is effective as the terminator.

5.2 GPIB Control

5.2.1 Introduction

The GPIB is a parallel port designed to be used for communication between instruments (listeners) and control devices (talkers) such as PCs fitted with a suitable interface card. The interface protocol is defined by the IEEE488.1 standard. Some additional generic capabilities of the listeners and talkers are defined by IEEE488.2. The SCPI standard defines the highest level of command structure including a number of standard commands for all instruments.

5.2.2 Interface Specification

The IEEE 488.1 bus standard and the IEEE 488.2 code standard are fully supported. The command set has also been designed to the SCPI standard.

The IEEE 488.1 functions supported

SH1	Full source handshake
AH1	Full acceptor handshake
T6	Basic talker, serial poll, no talk only, untalk if MLA
TE0	No talker with secondary addressing
L4	Basic listener, no listen only, unlisten if MTA
LE0	No listener with secondary addressing
SR1	Full service request
DC1	Full device clear
RL1	Full remote/local compatibility
PP0	No parallel poll
DT1	Full device trigger compatibility
C0	No controller

5.2.3 GPIB Address

The default address is 6. This cannot be changed.

5.2.4 Message Syntax

A GPIB message is made up of one or more commands. Commands can be separated into two groups, **common commands** and **subsystem commands**. The available common commands are defined by IEEE488.2 and are primarily concerned with the instrument's GPIB configuration, e.g. reading error registers and identifying the instrument. The subsystem commands are the higher level commands that follow the SCPI guidelines and are concerned with setting up the instrument functions, e.g. changing the frequency and drive level.

5.2.4.1 Message structure

Messages are sent to the instrument as ASCII character strings. The structure of these strings can be seen in Figure 5-1. When interpreting the strings the instrument is not case-sensitive.

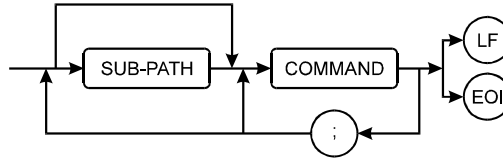

Figure 5-1 GPIB Message Structure

The path command prefix allows access to commands in the SCPI command tree. Using this approach greatly simplifies GPIB programming by allowing related commands to be grouped together. The next part of the string is the command itself which has the structure shown in Figure 5-2. Multiple commands can be sent in one message by separating them with a semicolon (maximum length 256 bytes). The terminator indicates the end of the command string to the instrument: this can be the sending of the line-feed character (ASCII 0Ah) and/or the assertion of the EOI handshake line on the GPIB bus.

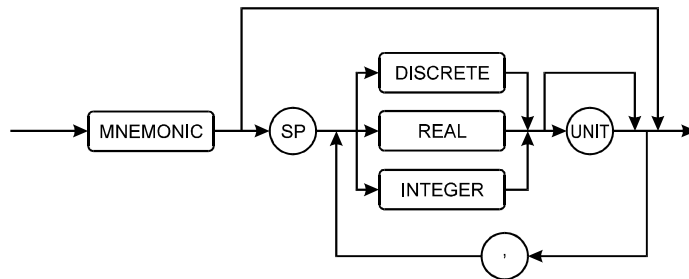

Figure 5-2 GPIB Command Structure

Each instrument command begins with a mnemonic that describes the required action, e.g. `FREQ` for changing the frequency.

If the command requires a parameter, then the next character should be a white space character (ASCII 20h), although any character in the range 00h-20h can be used with the exception of line-feed (ASCII 0Ah).

The parameter itself can take one of three forms depending on the command:

1) Discrete data

This includes words like `ON`, `OFF` and `ABS`.

2) Real Number

A floating point number that can be in engineering format or a number with a multiplier suffix `K` (kilo-), `M` (mega-) or `G` (giga-).

For example:

`FREQ 1000.0`

`FREQ 1E+3`

```
FREQ 0.1E4
```

```
FREQ 1k
```

are all valid ways of setting a frequency of 1kHz.

3) Integer

A single integer number. Often used to indicate a Boolean state.

For example:

```
RANGE 1
```

will select range 1.

If invalid data is supplied then a command error will be generated. If data is supplied but the instrument is not able to apply the setting, an execution error will be generated. If the instrument is unable to exactly comply with the command and can only apply the nearest available, a device specific error is generated. Details of these error codes can be found in Figure 5-6.

5.2.4.2 Hierarchical Commands

As described in the previous section, SCPI uses a command tree to simplify device programming. This structure is similar to the directory structure used on most computers. To access a specific command in a specific mode the user must supply the 'path' to reach that particular command within the tree.

When the unit is powered up the initial path is 'root' which is the top level from which all paths must start.

Note that common commands (which by convention always start with the '*' character) are not part of the tree and can be accessed regardless of the current path.

So to select the impedance measurement function in deviation mode, the path must describe the command tree as below:

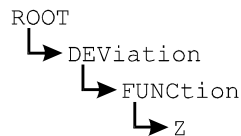

The ':' character is used as the path separator so the command string will be:

```
:DEV:FUNC:Z
```

Note that the string starts with ':'. This tells the instrument to start from the 'root' path. Whenever a terminator is reached (line-feed and/or EOI) the path is reset to the root path, so each new GPIB command string must state the full path in order to work correctly, for example:

To set a measurement frequency of 1kHz at a level of 1.0V, the following string can be used:

```
:MEAS:FREQ 1k;LEV 1.0V <line-feed>
```

Or it can be expressed as two separate commands:

```
:MEAS:FREQ 1k <line-feed>
:MEAS:LEV 1.0 <line-feed>
```

However, the following will not work as the second command will be run from the 'root' path, not the measurement path which was required:

```
:MEAS:FREQ 1k      <line-feed>
LEV 1.0           <line-feed>
```

Summary: The following are the rules for negotiating the command hierarchy

- On power-up or reset, the current path is set to the root.
- Message terminator, line-feed (ASCII 0Ah) or EOI, sets the current path to the root.
- When a colon is the first character of a command, it specifies that the next command mnemonic is a root level command.
- When a colon is placed between two path mnemonics, the current path is moved down one level in the command tree if the path name is valid.
- A semicolon separates two commands in the same message without changing the current path.
- If a command requires more than one parameter, the separate adjacent parameters must be specified using a comma. Commas do not affect the current path.
- Common commands, such as *RST, *RCL, are not part of the tree. An instrument interprets them in the same way, regardless of the current path setting.

Other syntax rules

- Commands will be executed in the order in which they appear in the string.
- A command string can contain any number of 'query commands': the response will contain the replies to each query separated by a semicolon.
- Only commands available in the selected mode will be accepted. Otherwise, an Execution Error will be generated. For example, AC frequency cannot be set if Rdc type of test is selected
- Either full or abbreviated forms of the device specific commands will be accepted. The abbreviated form is indicated by upper case letters in section 5.3.
- Device specific commands have the same effect as pressing the equivalent front panel key and can be expected to interact with any other instrument settings in the same way.

5.2.5 Data Output

5.2.5.1 Output Syntax

For each query which generates an output response, a Response Message Unit (RMU), will be generated. This consists of a string of numbers or alphanumeric characters; if more than one RMU is generated they will be delimited with a semicolon. The terminator, line-feed and EOI asserted indicates the end of data output. All characters will be upper case.

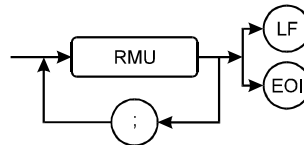

Figure 5-3 GPIB Data Output

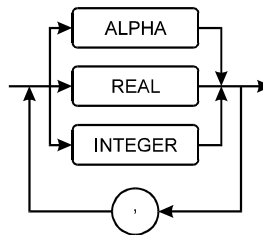

Figure 5-4 GPIB RMU Structure

5.2.5.2 Multiple Items

Some commands will generate an RMU containing more than one item of data (e.g. TRIG will generate a first and second result). In this case, each item of response data will be separated by a comma. Note that the maximum number of characters that can be output is 256, any data beyond this will be lost.

If the command string contained multiple queries then the response will contain multiple RMUs, each of which will be separated by a semicolon.

5.2.5.3 Numeric Format

The format of numeric results will correspond to that used for the instrument display, with the engineering multiplier (if any) replaced by an equivalent 10's exponent. If the FAST-GPIB mode is being used then numbers will be output in a raw engineering format.

5.2.6 Status Reporting

5.2.6.1 Status byte

The status byte is used to summarize information from the other status groups. It is shown in Figure 5-5, which conforms to IEEE 488.2 and SCPI. The status byte can be read by the query command *STB? or by performing a serial poll on the instrument (these two are identical although the point at which the RQS bit can be cleared is slightly different).

BIT	Meaning True = '1'
7	Operation Status Event Register summary bit. This bit is true when measurement or trimming etc., is in progress
6	RQS – ReQuest for Service. When the bit in the Service Request Enable mask is set with the corresponding bit in the status register true, this will trigger a service request to the controller. MSS – Master Summary Status bit. The version of the request for service bit which appears in the Status Byte.
5	ESB – Event Summary Bit. When unmasked by the ESE register, this bit will be set whenever the corresponding bit or bits are set in the Event Status Register.
4	MAV – Message available. The output queue has data to be read.
3	A summary bit from Questionable Data. This bit is not used, so is always 0.
2	This is a summary bit of error and instrument status messages. True if any new status information is available.
1	Always 0.
0	Always 0.

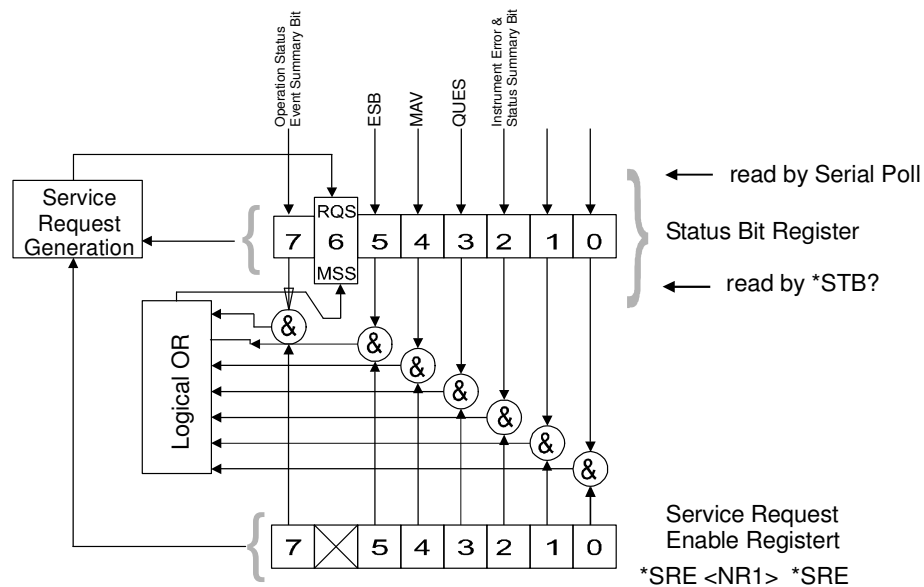

Figure 5-5 Status Byte Register

5.2.6.2 Service Request Enable Register

The service request enable register (SRE) is a mask determining the conditions in which the SBR will generate a service request. It is bit-wise ANDed with the SBR and if the result is not

zero then bit 6 of the SBR is set (see Figure 5-5). The SRE is set by the *SRE command and read by the *SRE? command.

5.2.6.3 Standard Event Status Register

The standard event status register (ESR) contains the 8 bits of the operation status report which is defined in IEEE 488.2. If one or more event status bit is set to '1' and their enable bits are also '1', bit 5 (called ESB) of the status register byte is set to '1'.

Each bit of the standard event status register is shown below.

BIT	Name	Meaning (True = '1')
7	Power On (PON)	True when the instrument power supply has been turned OFF and then ON since the last time this register was read.
6	User Request (URQ)	Not used. Always 0.
5	Command Error (CME)	True if the following command errors occur: An IEEE 488.2 syntax error occurred. The device received a Group Execute Trigger (GET) inside a program message.
4	Execution Error (EXE)	True when a parameter following a header of a GPIB command was evaluated by the instrument as being outside of its legal input range or is otherwise inconsistent with the instrument's capabilities.
3	Device Dependent Error (DDE)	True when any bit is set in the Encoded Message Register.
2	Query Error (QYE)	True when attempting to read data from the output buffer in which no data was present, or when the data was lost.
1	Request Control (RQC)	Not used. Always 0.
0	Operation Complete (OPC)	True when the instrument has completed all selected pending operations before sending the *OPC command

Figure 5-6 Standard Event Status Register

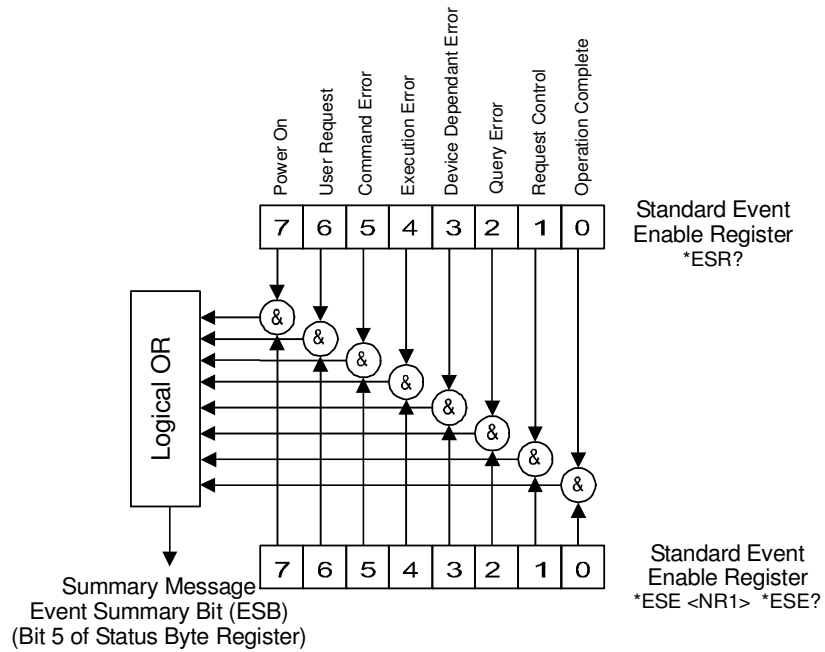

Figure 5-7 Event Status Byte Register

5.2.6.4 Event Status Enable Register

The event status enable register (ESE) is a mask determining the conditions in which the ESR will set bit 5 of the SBR. It is bit-wise ANDed with the ESR and if the result is not zero then ESB (bit 5) of the SBR is set (see Figure 5-7). Thus any event affecting the ESR can be made to generate a Service Request in conjunction with the ERE and the SRE.

The event status enable is set by the *ESE command and read by the *ESE? command.

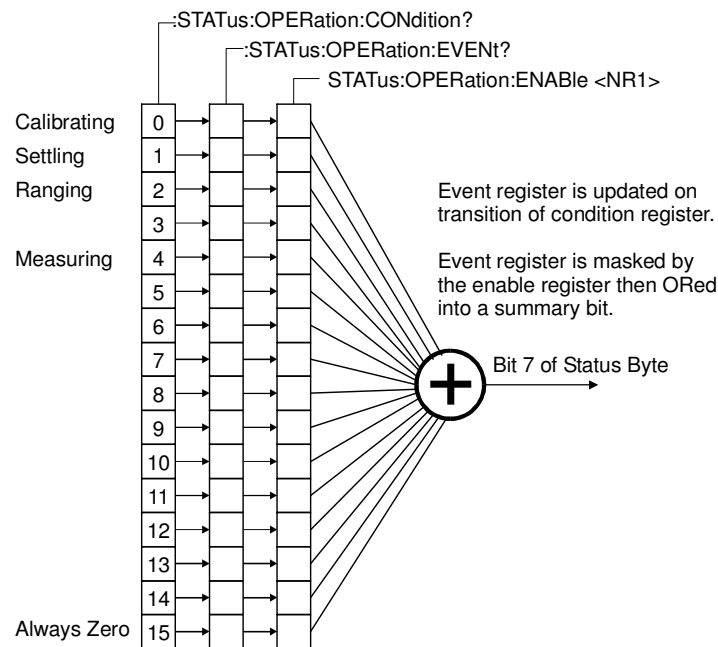

Figure 5-8 Standard Operation Status Group

5.2.6.5 Standard Operation Status Group

The standard operation status group provides information about the state of the measurement systems in the instrument. This status group is accessed through the STATus subsystem. Standard operation status includes a condition register, event register, and an enable register. Figure 5-8 illustrates the structure of standard operation status.

5.2.6.6 Standard Operation Status Condition Register

This is a 16-bit register gathering information about the state of the measurement systems in an instrument. According to SCPI recommendation, we define:

BIT	Meaning (True = '1')
0	Calibrating bit which is true when S/C trimming, O/C trimming, or calibrating is in progress, and otherwise reset.
4	Measuring bit which is true when measurement is in progress, and otherwise reset.

Other bits are unused and are 0.

5.2.6.7 Standard Operation Status Event Register

This is a 16-bit register; each event bit in the event register corresponds to a condition bit in the standard operation status condition register. According to SCPI recommendation, we define:

BIT	Meaning (True = '1')
0	True when S/C trimming, O/C trimming, or calibration measurement is completed.
4	Set true when single shot measurement is completed.

Other bits are uncommitted and are always 0.

5.2.7 Common Commands

Common commands are listed below. Their detailed description will be given later.

Command	Name	Description
*CLS	Clear Status	Clears the Event Status Register and associated status data structure.
*ESE <NR1>	Event Status Enable	Sets the Event Status Enable Register to the value of the data following the command.
*ESE?	Event Status Enable Query	Returns the current contents of the Standard Event Status Enable Register as an integer in the range 0 to 255.
*ESR?	Event Status Register Query	Returns the current contents of the Standard Event Status Register as an integer in the range 0 to 255. It also clears ESR.
*SRE <NR1>	Service Request Enable	Sets the Service Request Enable Register to the value following the command. The register is set except that bit 6 is ignored.
*SRE?	Service Request Enable Query	Returns the current contents of the Service Request Enable Register as an integer in the range 0 to 63 and 128 to 255.
*STB?	Status Byte Query	Returns the current contents of the Status Byte with the Master Summary bits as an integer in the range 0 to 255. Bit 6 represents Master Summary Status rather than Request Service.
*IDN?	Identification Query	Returns the data identifying the instrument. (e.g. the data output will be: 'Wayne Kerr,4310,0,1.0' where the first field is the manufacturer, then the model number, then a zero and the software revision number: here represented as Issue 1.0).
*RST	Reset	Resets the instrument to a default setting. This command is equivalent to a power-up reset.
*TRG	Trigger	Triggers a direct measurement, but does not return the results to the controller. This is the same as a GET (Group Execute Trigger) command.

Command	Name	Description
*OPT?	Option Identification Query	Returns the hardware options installed in the instrument.
*OPC	Operation Complete Command	Sets the OPC bit of the ESR register.
*OPC?	Operation Complete Query	Always returns 1 as instrument commands are always processed sequentially.
*WAI	Wait-to-continue	Command has no effect as commands are processed sequentially.

5.2.8 Standard Operation Status Commands

Refer to section 5.2.6 for an explanation of the following commands.

Command	Description	Query
	Read Status Operation Condition register.	:STATus:OPERation:CON?
	Read Status Operation Event register	:STATus:OPERation:EVENT?
:STATus:OPERation:ENABLE <NR1>	Set Status Operation Enable Register	
	Read Encoded Message Register	:MESSAge?

5.3 4300 Device-Specific Commands

The sub-system commands are grouped in different modes similar to the local operation. The recommended discipline to control the instrument under GPIB and RS-232 is to select the type of test first, then change the measurement conditions. Trying to change measurement conditions which are not in the present mode and type of test will be rejected and return an error flag.

5.3.1 Command Summary

Command	Summary	Page
:MEAS:TRIGger	Trigger an AC or Rdc measurement.	5-14
:MEAS:FREQuency <real>	Set frequency of AC measurement.	5-14
:MEAS:FREQuency?	Frequency query.	5-14
:MEAS:LEVel <real>	Set drive level for currently selected test.	5-14
:MEAS:LEVel?	Drive level query.	5-14
:MEAS:SPEED <disc>	Select measurement speed.	5-15
:MEAS:SPEED?	Speed query.	5-15
:MEAS:RANGE <disc>	Select auto-ranging or range-hold on range N.	5-15
:MEAS:RANGE?	Range query.	5-15
:MEAS:EQU-CCT <disc>	Select equivalent circuit.	5-16
:MEAS:EQU-CCT?	Equivalent circuit query.	5-16
:MEAS:FUNC1	Select first measurement function.	5-16
:MEAS:FUNC2	Select second measurement function	5-17
:MEAS:FUNC1?	First measurement function query	5-18
:MEAS:FUNC2?	Second measurement function query	5-19
:CAL:OC-TRIM <integer>	Perform open circuit trimming.	5-20
:CAL:SC-TRIM <integer>	Perform short circuit trimming.	5-20
:CAL:RES?	Returns the result of the calibration performed.	5-20
:TRIGger	Trigger a measurement in the current mode.	5-21
:DUMP-BMP	Returns the display as a windows compatible bitmap.	5-21

MEASUREMENT MODE

:MEAS:TRIGger

Trigger a measurement using the current settings.

Parameters:

None.

Response:

For AC measurements the response will be the first and second measurements separated by a comma.

Example: 68.860E-9 , 13.0E+6

For Rdc measurements the response will be a single measurement result.

Example: 6.2295E+3

:MEAS:FREQuency <real>

Set frequency of AC measurement.

Parameters:

The required frequency in Hertz. The unit suffix 'Hz' is optional.

Example: MEAS:FREQ 1000
sets the test frequency to 1kHz.

Response:

None.

:MEAS:FREQuency?

Returns the current AC test frequency.

Parameters:

None.

Response:

Returns the current test frequency in engineering format.

Example: +.10000000E+04
for a test frequency of 1kHz.

:MEAS:LEVel <real>

Set drive level for currently selected test.

Parameters:

For AC tests supply the required drive level in either Volts or Amps.

Example: MEAS:LEV 1.2
will select drive levels of 1.2V.

Response:

None.

:MEAS:LEVel?

Drive level query.

Parameters:

None.

Response:

Returns the current test level in engineering format.

Example: +.20000000E-01
for a test level of 20mV.

MEASUREMENT MODE	
<p>:MEAS:SPEED <disc></p> <p>Select the required measurement speed.</p> <p>Parameters:</p> <p>MAX Maximum speed. FAST Fast speed. MED Medium speed. SLOW Slow speed.</p> <p>Example: :MEAS:SPEED SLOW will select slow speed for measurements.</p> <p>Response:</p> <p>None.</p>	<p>:MEAS:SPEED?</p> <p>Returns the current test speed.</p> <p>Parameters:</p> <p>None.</p> <p>Response:</p> <p>Returns the test speed as an integer according to the table:</p> <p>0 Maximum 1 Fast 2 Medium 3 Slow</p> <p>Example: 1 indicates that Fast measurements are selected.</p>
<p>:MEAS:RANGE <disc></p> <p>Select the required measurement range condition for AC and RDC tests.</p> <p>Parameters:</p> <p>The following parameters are valid:</p> <p>AUTO Auto-ranging. 1 to 8 Range 1 to 8</p> <p>Example: MEAS:RANGE 1 MEAS:RANGE AUTO will select range 1 and auto-ranging respectively.</p> <p>Response:</p> <p>None.</p>	<p>:MEAS:RANGE?</p> <p>Returns the current measurement range.</p> <p>Parameters:</p> <p>None.</p> <p>Response:</p> <p>Returns the measurement range as an integer according to this table:</p> <p>0 Auto-ranging. 1-8 Current measurement range.</p> <p>Example: 0 indicates that auto ranging is selected.</p>

MEASUREMENT MODE

:MEAS:EQU-CCT <disc>

Select the equivalent circuit type for AC tests.

Parameters:

The following parameters are valid:

SER Series equivalent circuit.

PAR Parallel equivalent circuit.

Example: :MEAS:EQU-CCT SER
will select the series equivalent circuit.

Response:

None.

:MEAS:EQU-CCT?

Returns the currently selected equivalent circuit.

Parameters:

None.

Response:

Returns the equivalent circuit flag according to this table:

0 Parallel.

1 Series.

Example: 0

indicates the parallel equivalent circuit is selected.

:MEAS:FUNC1

Select first measurement function (Func 1).

:MEAS:FUNC1 C	Capacitance
:MEAS:FUNC1 L	Inductance
:MEAS:FUNC1 X	Reactance
:MEAS:FUNC1 B	Susceptance
:MEAS:FUNC1 Z	Impedance
:MEAS:FUNC1 Y	Admittance
:MEAS:FUNC1 Q	Quality factor
:MEAS:FUNC1 D	Dissipation factor
:MEAS:FUNC1 R	Resistance
:MEAS:FUNC1 G	Conductance
:MEAS:FUNC1 A	Phase Angle
:MEAS:FUNC1 RDC	DC Resistance

Example: :MEAS:FUNC1 C

will select Capacitance.

Response:

None.

MEASUREMENT MODE**:MEAS:FUNC2**

Select second measurement function (Func 2).

:MEAS:FUNC2 C	Capacitance
:MEAS:FUNC2 L	Inductance
:MEAS:FUNC2 X	Reactance
:MEAS:FUNC2 B	Susceptance
:MEAS:FUNC2 Z	Impedance
:MEAS:FUNC2 Y	Admittance
:MEAS:FUNC2 Q	Quality factor
:MEAS:FUNC2 D	Dissipation factor
:MEAS:FUNC2 R	Resistance
:MEAS:FUNC2 G	Conductance
:MEAS:FUNC2 A	Phase Angle

Example: :MEAS:FUNC2 D

will select Dissipation factor.

Response:

None.

MEASUREMENT MODE

:MEAS:FUNC1?

First measurement function (Func 1) query.

Parameters:

None

Response:

Returns the measurement type according to this table:

- 0 Capacitance
- 1 Inductance
- 2 Reactance
- 3 Susceptance
- 4 Impedance
- 5 Admittance
- 6 Quality factor
- 7 Dissipation factor
- 8 Resistance
- 9 Conductance
- 10 Phase Angle
- 11 DC Resistance

Example: 4

indicates that the first measurement is impedance (Z)

MEASUREMENT MODE**:MEAS:FUNC2?**

Second measurement function (Func 2) query.

Parameters:

None

Response:

Returns the measurement type according to this table:

- 0 Capacitance
- 1 Inductance
- 2 Reactance
- 3 Susceptance
- 4 Impedance
- 5 Admittance
- 6 Quality factor
- 7 Dissipation factor
- 8 Resistance
- 9 Conductance
- 10 Phase Angle

Example: 1

indicates that the second measurement is Inductance (L)

CALIBRATE MODE

:CAL:OC-TRIM <integer>

Perform open circuit trimming.

Parameters:

The required trim type.

4 All frequency

Example: :CAL:OC-TRIM 4

would perform an open circuit trim across the whole frequency range of the unit.

Response:

None.

:CAL:SC-TRIM <integer>

Perform short circuit trimming.

Parameters:

The required trim type.

4 All frequency

Example: :CAL:SC-TRIM 4

would perform a short circuit trim across the whole frequency range of the unit.

Response:

None.

:CAL:RES?

Returns the result of the most recent trim or calibration performed.

Parameters:

None.

Response:

The trim flag:

1 Calibration passed.

0 Calibration failed.

Example: 1

would indicate that the last trim or calibration was successful.

ROOT COMMANDS**:TRIGger**

Trigger a measurement in the current mode.

Parameters:

None.

Response:

The measurement result depending on the mode.

:DUMP-BMP

This command does not work when using RS-232.

Returns the display pixel data in windows compatible bitmap (.bmp) file.

Parameters:

None.

Response:

None.

6. BINNING

6.1 OVERVIEW

Binning allows components to be measured and then sorted into bins according to limits set by the user. The 4300 Binning function allows three types of limits (Bin Types) to be defined, depending on the number of parameters being measured. The Binning function is an option for the 4300 and there are two versions available, /B1 (outputs non-isolated) and /B2 (outputs isolated). Throughout this section, TERM1 and Func 1 mean the same, as do TERM 2 and Func 2.

6.2 BIN TYPES

Binning can be performed using the Term 1 and Term 2 measurements in three different ways:

Bin Type	TERM1	TERM2	PASS/FAIL signal
One Term	Sort into 3 bins	Not used	BIN 0 = PASS
One Term Dual Limits	Term 1 same as Term 2: sort into 5 bins		BIN 0, 3 & 4 = PASS
Two Term	Term1 & Term 2 any parameter: sort into 5 bins		BIN 0 = PASS

6.2.1 ONE TERM BIN TYPE

One Term binning only uses the TERM1 measurement with a Low Limit (LL1) and a High Limit (HL1) to bin:

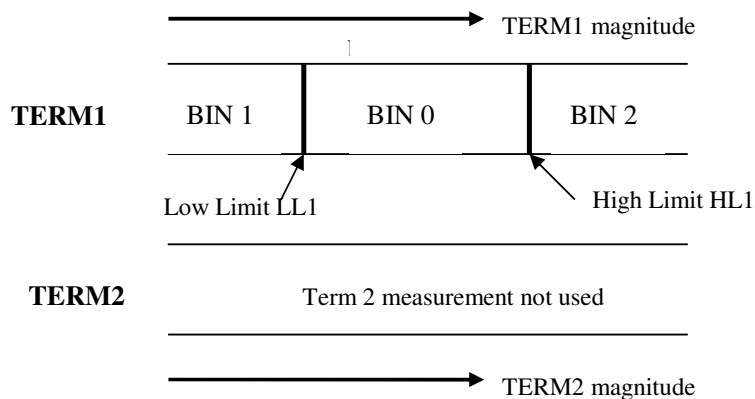

Figure 6-1 One Term Bin Type diagram

One Term binning can also be illustrated using the following diagram:

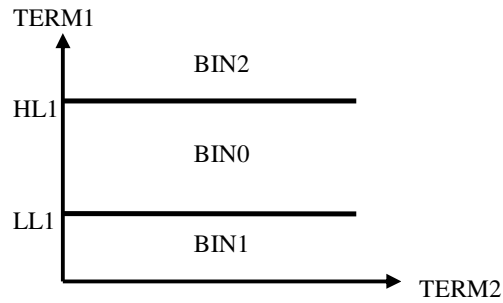

Figure 6-2 One Term Bin Type two axis diagram

The following flow chart shows the decision process used to sort the DUT into bins:

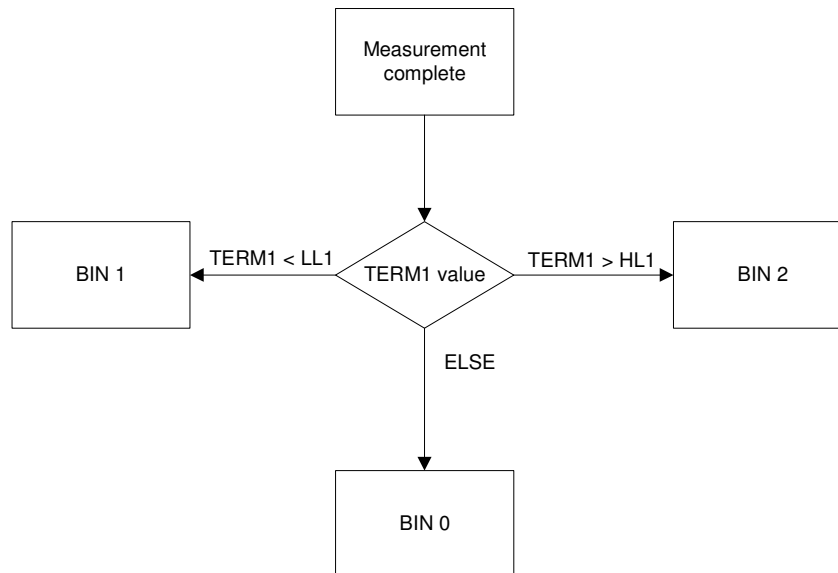

Figure 6-3 One Term Bin Type flow chart

An example of One Term binning:

TERM1 measures R_s

TERM2 measures L_s

TERM1 Low Limit (LL1) set to 0.9Ω

TERM1 High Limit (HL1) set to 1.1Ω

TERM1 value	TERM2 value	BIN	PASS/FAIL
$<0.9\Omega$	ANY	1	FAIL
Between 0.9Ω and 1.1Ω		0	PASS
$>1.1\Omega$		2	FAIL

6.2.2 ONE TERM DUAL LIMITS BIN TYPE

One Term Dual Limits uses the 4300's ability to set TERM1 & TERM2 to the same parameter. This results in the same measurement being displayed twice, once as TERM1 and once as TERM2. This means that two sets of limits can be applied to the one measurement, and more bins can be used for increased information. A typical use for this feature is to bin using two tolerance bands. The example below bins capacitors using $\pm 5\%$ and $\pm 2\%$ tolerances.

The following explanation still use TERM 1 and TERM 2, but for One Term Dual Limits binning, TERM 1 and TERM 2 are the same measurement.

Two sets of limits are set, and LL2 and HL2 must lie within the region defined by LL1 and HL1.

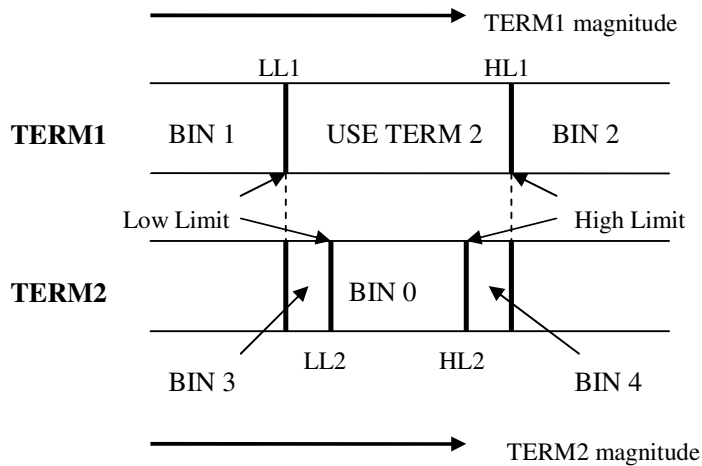

Figure 6-4 One Term Dual Limits Bin Type diagram

One Term Dual Limits binning can also be illustrated using the following diagram:

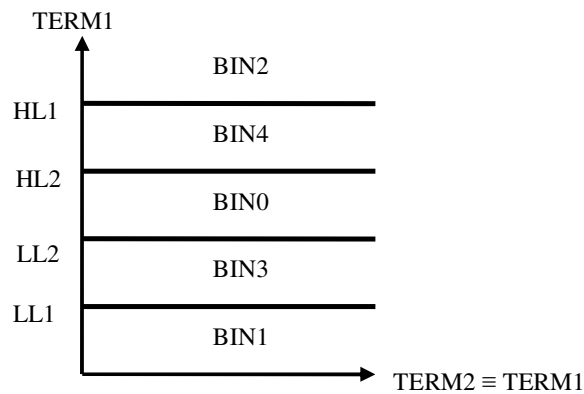

Figure 6-5 One Term Dual Limits Bin Type two axis diagram

The following flow chart shows the decision process used to sort the DUT into bins:

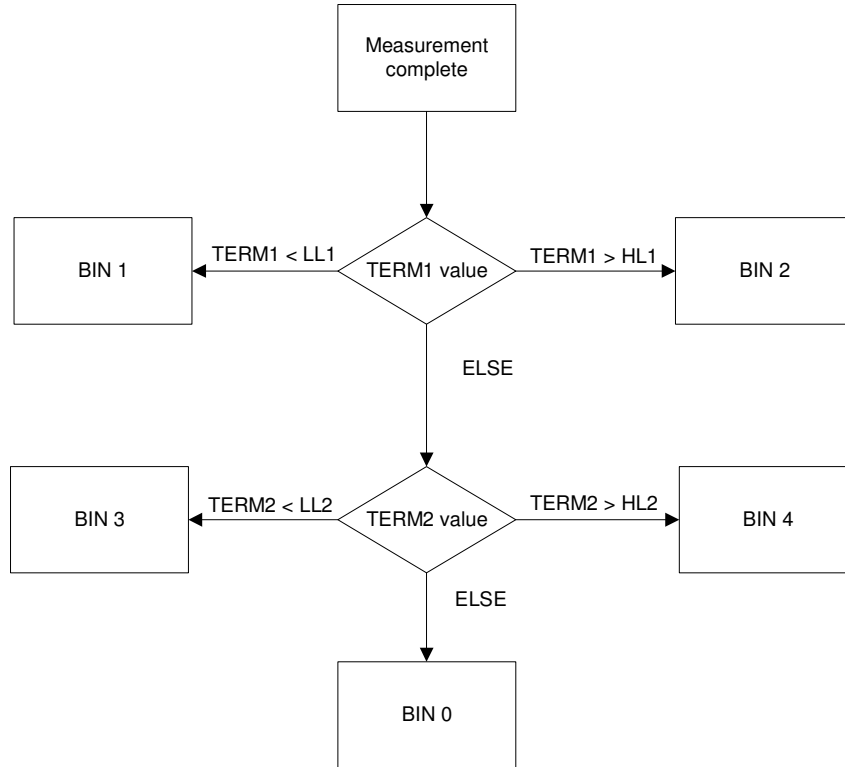

Figure 6-6 One Term Dual Limits Bin Type flow chart

An example of One Term Dual Limits binning:

TERM1 measures Cp

TERM2 measures Cp

Nominal set to 1nF

TERM1 Low Limit (LL1) set to -5% TERM2 Low Limit (LL2) set to -1%

TERM1 High Limit (HL1) =set to +5% TERM2 High Limit (HL2) set to +1%

TERM1 value	TERM2 value	BIN	PASS/FAIL
<0.95nF	-	1	FAIL
Between 0.95 & 1.05nF	Between 0.95 & 0.99nF	3	PASS
	Between 0.99 & 1.01nF	0	PASS
	Between 1.01 & 1.05nF	4	PASS
>1.05nF	-	2	FAIL

6.2.3 TWO TERM BIN TYPE

Two Term binning uses TERM1 and TERM2 measurements. TERM1 and TERM2 can be different parameters. The TERM1 measurement uses a Low Limit (LL1) and a High Limit (HL1) and the TERM2 measurement uses a Low Limit (LL2) and a High Limit (HL2).

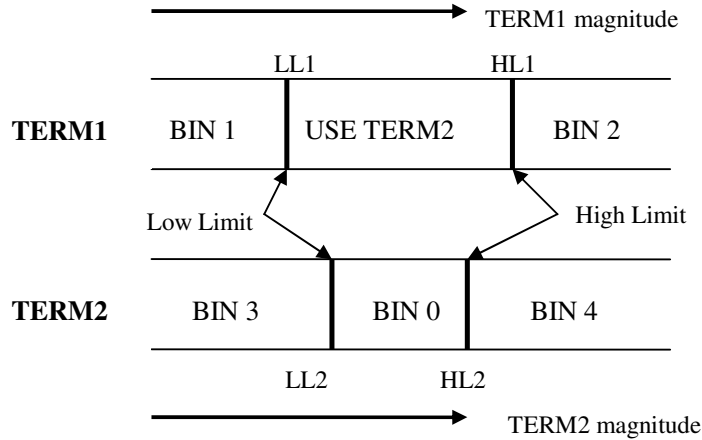

Figure 6-7 One Term Dual Limits Bin Type diagram

Two Term binning can also be illustrated using the following diagram:

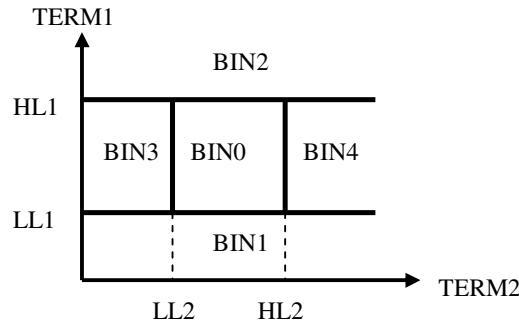

Figure 6-8 Two Term Bin Type two axis diagram

The following flow chart shows the decision process used to sort the DUT into bins:

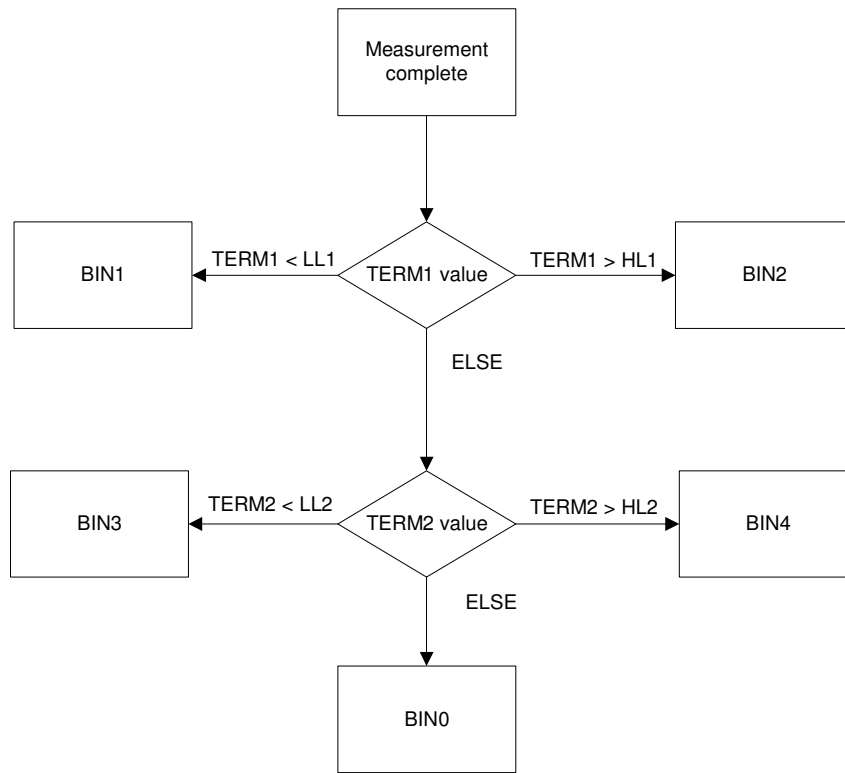

Figure 6-9 Two Term Bin Type flow chart

An example of Two Term binning:

Example: TERM1 measures R_s

TERM2 measures L_s

TERM1 Low Limit (LL1) set to 0.9Ω TERM2 Low Limit (LL2) set to $4.23\mu\text{H}$

TERM1 High Limit (HL1) set to 1.1Ω TERM2 High Limit (HL2) set to $5.17\mu\text{H}$

TERM1 value	TERM2 value	BIN	PASS/FAIL
$<0.9\Omega$	ANY	1	FAIL
Between 0.9Ω & 1.1Ω	$<4.23\mu\text{H}$	3	FAIL
	Between $4.23\mu\text{H}$ & $5.17\mu\text{H}$	0	PASS
	$>5.17\mu\text{H}$	4	FAIL
$>1.1\Omega$	ANY	2	FAIL

6.3 SIGNALS

B1 version: All signals are non-isolated

B2 version: All signals are isolated using opto-couplers

Test result outputs and control outputs are identical for B1 and B2 versions

6.3.1 CONTROL INPUT:

B1 version: \overline{TRIG}

B2 version: Trigger input +ve pin

Trigger input -ve pin

6.3.2 TEST RESULT OUTPUT:

5 BIN's (numbered 0 to 4) for valid measurements

BIN 9 used for O/R (Out of Range) measurements

Pass/Fail output

6.3.3 CONTROL OUTPUT:

\overline{BUSY}

\overline{BDA} (Binning Data Available)

6.3.4 ELECTRICAL RATINGS

B1 version (non-isolated):

Parameter	Specification
Output High:	>4.0V
Output Low:	<1.0V
Input High:	>3.5V
Input Low:	<1.5V
Drive capability (low)	10mA sink
Drive capability (high)	30 μ A source

B2 version (isolated):

Parameter	Specification
Output On State current:	Up to 10mA at +24V
Output Off State current:	<0.5mA
Output On State voltage:	Input voltage -1.5V at 10mA
Input High current	>3mA
Input Low current	<1.25mA
Input High Voltage:	>15.4V
Input Low Voltage:	<8.0V

6.3.5 TIMING DIAGRAM:

Figure 6-10 Binning Timing diagram

Event	Description
1	\overline{TRIG} goes LO to indicate that the DUT is in position and ready for a binning cycle
2	\overline{BUSY} goes LO to acknowledge Event 1 and also to indicate the DUT is being measured
3	\overline{TRIG} goes HI to acknowledge Event 2. \overline{BUSY} stays LO to indicate the DUT is being measured
4	\overline{BUSY} goes HI at the end of the measuring period to indicate that the DUT can be removed from the handler and the next DUT attached. \overline{BDA} goes HI at the start of the Maths period to indicate that the BIN lines are invalid
5	\overline{BDA} goes LO to indicate that the result of the Maths period is now available on the BIN lines
6	TX period is used for the transmission of measurement & results data by remote control in real time (if required by user). Otherwise TX period can be ignored.

The two output signal lines, \overline{BUSY} and \overline{BDA} will at any time assume one of the four following different states:

1. Null State. \overline{BUSY} LO and \overline{BDA} HI in this state. The 4300 enters this state at power-up. When the Null State is detected by external hardware, it must be assumed that the signals on the BIN lines are invalid and should be ignored.
2. Ready For Trigger State. \overline{BUSY} is HI and \overline{BDA} is LO in this state. All BIN lines will be unchanged. If the previous state was Null State, then all BIN lines will be LO, meaning no bin selected, even though the \overline{BDA} line suggests that valid bin data is present. When the 4300 receives a trigger, it will respond by entering the Busy State.
3. Busy State. Both \overline{BUSY} and \overline{BDA} lines are LO in this state.
4. Not Busy State. Both \overline{BUSY} and \overline{BDA} are HI and all BIN lines are LO in this state. The 4300 has finished measuring the DUT and it may be removed and replaced by the next DUT. However the 4300 still has perform the Maths period so all the BIN lines are made invalid.

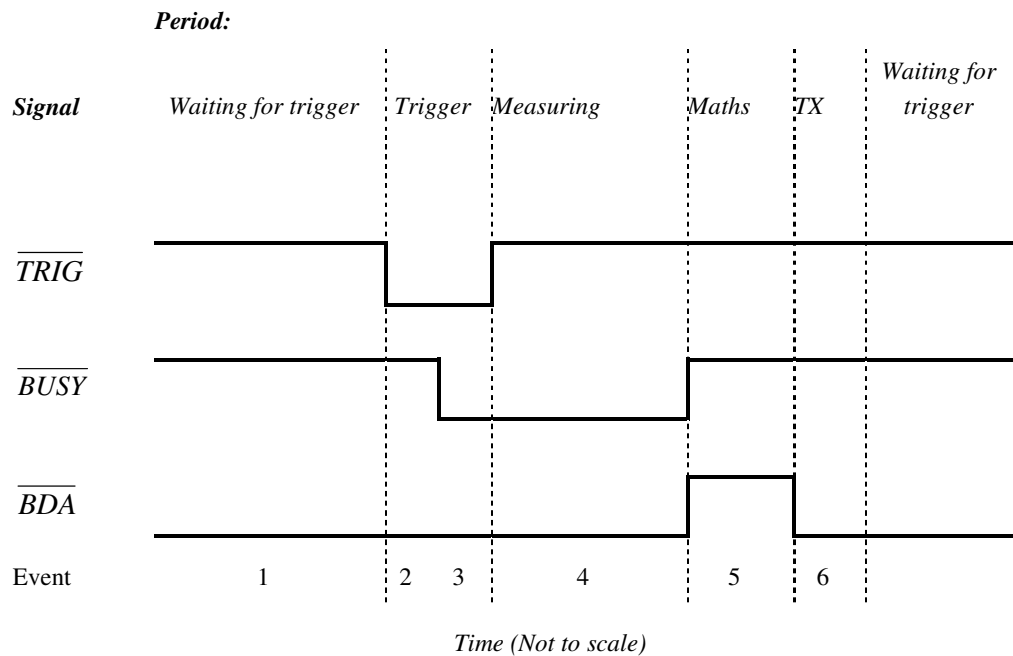
At power up, the 4300 recognizes if the B1 or B2 Bin Handler option is fitted, and takes the \overline{BUSY} line LO and the \overline{BDA} and all BIN lines HI.

Measurements may be triggered by pressing the **Trigger** key on the front panel or taking the \overline{TRIG} line LO. If a measurement is in progress when the 4300 is triggered, the measurement is aborted and a new measurement started.

6.4 SORT

The SORT page shows the measurement after a trigger is received. It also shows the resulting Bin, the total number of components tested, the type of Binning and the measurement conditions. A typical screen is shown below:

Set	Calibrate	Option	More	
Cp 1.5363nF				Total: 4
Dp 0.0043D				Bin 0
Two Term				
Function:	C + D	Equ. Cct.:	Parallel	Del Last
Level:	1.00 V	Frequency:	100 kHz	
Speed:	Slow	DC Bias:	Internal	
Range:	Auto : 4			

Figure 6-11 Sort Screen

6.5 COUNT

The Count Screen is used to shows the totals in each bin. A typical screen is shown below.

Set	Calibrate	Option	More	
Reject: 1 Total: 5				Del All
Bin 0: 4		Bin 3: 0		
Bin 1: 0		Bin 4: 1		
Bin 2: 0		Bin 9: 0		
Two Term				
Function:	C + D	Equ. Cct.:	Parallel	Del Last
Level:	1.00 V	Frequency:	100 kHz	
Speed:	Slow	DC Bias:	Internal	
Range:	Auto : 4			

Figure 6-12 Count Screen

7. 4300 LCR METER SPECIFICATION

Wayne Kerr Electronics reserves the right to change this specification without notice

7.1 Measurement Parameters

7.1.1 AC Functions

Two parameters can be displayed at the same time as Function 1 and Function 2. Any of the parameters can be selected and displayed on the instrument using the following letter:

Parameter	Letter	Parameter	Letter
Impedance	Z	Phase Angle	A
Capacitance	C	Dissipation Factor	D
Inductance	L	Quality Factor	Q
AC Resistance	R	Conductance	G
Susceptance	B	Reactance	X
Admittance	Y		

The following display formats are available:

7.1.2 Series or Parallel Equivalent Circuit

C, D, L, Q, R, G, B, and X – any combination (both as series or both as parallel)

7.1.3 Polar Form

Z + Phase Angle, Y + Phase Angle

7.1.4 DC Function

DC Resistance (Rdc) - Function 1 only

7.2 AC Drive Signal

7.2.1 Frequency Range and Points

Model	Frequency Range	Number of frequency points
4310	20Hz to 100kHz	557
4320	20Hz to 200kHz	577
4350	20Hz to 500kHz	637
43100	20Hz to 1MHz	737

7.2.2 Frequency Accuracy

Frequency	Accuracy
20Hz to 495Hz	$\pm 0.0075\%$ (75ppm)
$\geq 500\text{Hz}$	$\pm 0.005\%$ (50ppm)

7.2.3 Frequency Step Size

Frequency	Step Size
20Hz to 1kHz	5Hz
1kHz to 10kHz	50Hz
10kHz to 100kHz	500Hz
100kHz to 1MHz	5kHz

7.2.4 AC Drive Level

AC Drive	Drive Range	Detail	Number of AC Drive levels
Voltage	10mV to 2V	into open circuit	200
Current	100 μA to 20mA	into short circuit	200

7.2.5 Source Impedance

100 Ω $\pm 1\%$

7.2.6 DC Drive Level (Rdc)

DC Drive	Drive Range	Detail	Number of DC Drive levels
Voltage	1V or 2V	into open circuit	2

7.2.7 DC Bias Voltage

A DC bias voltage derived from an internal or external source can be applied to capacitors during AC measurements.

7.2.7.1 Internal

DC bias of 2V $\pm 5\%$.

Peak short circuit current <10mA

7.2.7.2 External

External bias of up to $\pm 40\text{V}$ is provided by connecting an external power supply to the rear panel bias terminals. Peak short circuit current $< 0.26\text{A}$

A resettable trip protects the bias circuit against a continuous short circuit.

7.3 Measurement Speed

There are four selectable speeds for all measurement functions. Selecting slower measurement speed increases reading resolution and reduces measurement noise by averaging.

The fastest measurement time (defined as the time from trigger to end of measurement in bin handler mode) is 20ms, subject to certain measurement conditions.

The following measurement times (includes keyboard scan and display update) are for AC measurements $\geq 1\text{kHz}$ and for Rdc.

Speed	Measurement Time	Suggested Application
Maximum	72ms	automatic sorting
Fast	108ms	non-critical measurements
Medium	253ms	improved resolution
Slow	445ms	best resolution and enhanced supply frequency rejection

7.4 Measurement Range

Parameter	Range	
R, Z, X	0.01m Ω to >1G Ω	10^{-5} to >10 ⁹ Ω
G, Y, B	0.1nS to >2kS	10^{-10} to >2x10 ³ S
L	1nH to >2kH	10^{-9} to >2x10 ³ H
C	0.01pF to >1F	10^{-14} to >1F
D, Q	0.0001 to 9999.9	10^{-4} to 9.9999x10 ⁴
Rdc	0.1m Ω to >100M Ω	10^{-4} to >10 ⁸ Ω

7.5 Modes Of Operation

7.5.1 Measurement

Single and repetitive measurements of any two parameters displayed as Function 1 and Function 2.

Analogue scale with configurable Hi/Lo limits giving PASS/FAIL indication.

7.5.2 Binning (Option)

B1 version: All signals are non-isolated

B2 version: All signals are isolated using opto-couplers

Test result outputs and control outputs are identical for B1 and B2 versions

7.5.2.1 CONTROL INPUT:

B1 version: \overline{TRIG}

B2 version: Trigger input +ve pin

Trigger input -ve pin

7.5.2.2 TEST RESULT OUTPUT:

5 BIN's (numbered 0 to 4) for valid measurements

BIN 9 used for O/R (Out of Range) measurements

Pass/Fail output

7.5.2.3 CONTROL OUTPUT:

\overline{BUSY}

\overline{BDA} (Binning Data Available)

7.5.2.4 ELECTRICAL RATINGS

B1 version (non-isolated):

<i>Parameter</i>	<i>Specification</i>
Output High:	>4.0V
Output Low:	<1.0V
Input High:	>3.5V
Input Low:	<1.5V
Drive capability (low)	10mA sink
Drive capability (high)	30 μ A source

B2 version (isolated):

<i>Parameter</i>	<i>Specification</i>
Output On State current:	Up to 10mA at +24V
Output Off State current:	<0.5mA
Output On State voltage:	Input voltage -1.5V at 10mA
Input High current	>3mA
Input Low current	<1.25mA
Input High Voltage:	>15.4V
Input Low Voltage:	<8.0V

7.5.3 Save and Recall

20 different measurement set-ups can be saved and recalled

7.6 Measurement Connections

4 front panel BNC connectors permit 4-terminal connections with the screens at ground potential.

Terminals withstand connection of charged capacitor up to following limits:

- a capacitor charged to between 50V and 500V with a stored energy of less than 0.25J, either polarity.

7.7 Measurement Accuracy

Iso-accuracy charts define the specified accuracies, over the available frequency band and impedance range. All curves assume that Slow measurement speed is used, that the instrument has been trimmed at the frequency used for measurements, that factory calibration is valid and that the component under test is pure.

For above and below the ranges indicated in the following charts, the accuracy degrades linearly with increasing/decreasing DUT value.

7.7.1 R / G / Y / Z Accuracy Chart

4300 Impedance Measurement Accuracy

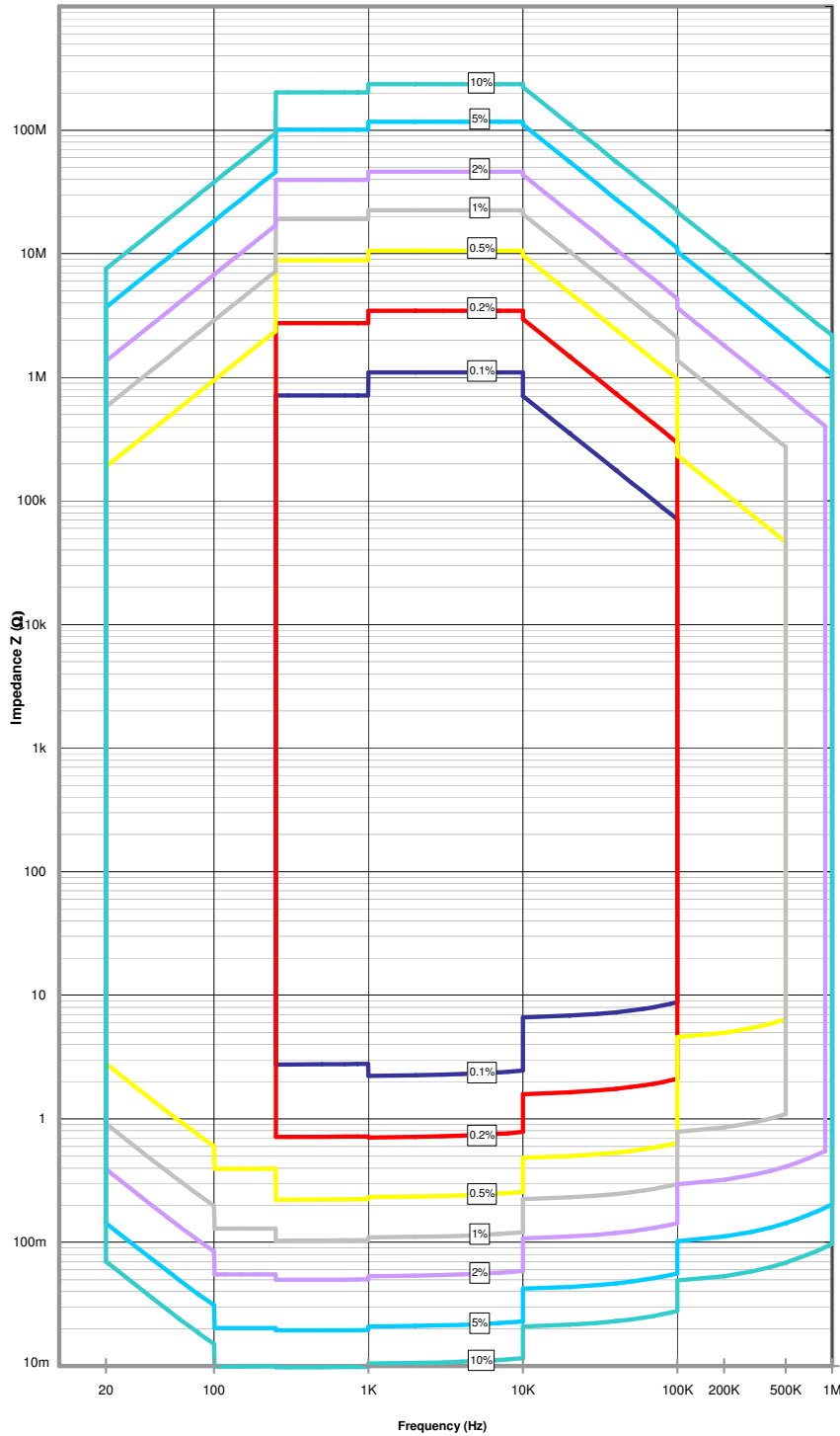

Conditions
 AC Drive Level: 1V/10mA
 Speed: Slow
 Instrument trimmed at measurement frequency.
 Q: ≤ 0.1
 Fixture: 1EV1006
 Temperature range: 25 \pm 5°C

Supply frequency rejection may also cause additional unquantifiable errors dependent on lead layout, particularly at frequencies below 600Hz and at lower AC drive levels.

For impure components, and for measurements of the highest and lowest available ranges, full accuracy expressions, shown below, apply. If $1 > Q > 0.1$, multiply R accuracy by $(1+Q)$.

Conductance (G)
 Find accuracy for equivalent R value from $R = 1/G$

Admittance (Y)
 Find accuracy for equivalent Z value from $Z = 1/Y$.

7.7.2 Rdc Accuracy

Resistance Range	Accuracy
10Ω to 1MΩ	±0.2%

7.8 General

7.8.1 AC Input

Parameter	Specification
Voltage	90 to 264V AC autoranging
Frequency	45 to 63Hz
Power	15W max
Input fuse* rating	1.6A T HRC

*The input fuse is in the fuse holder drawer integral to the IEC input connector.

7.8.2 Display

High contrast black and white LCD module 3.8" 1/4VGA (320 x 240 pixels) with CPL back lighting.

7.8.3 Remote Control

RS232C

GPIB IEEE-488.2 (SCPI 1992.0)

7.8.4 Remote Trigger

Rear panel BNC with internal pull-up, operates on logic low or contact closure.

7.8.5 Mechanical

Parameter	Specification
Height	104mm (4.1")
Width	322mm (12.7")
Depth	285mm (11.2")
Weight	3kg (6.6lbs)

7.9 Environmental conditions

This equipment is intended for indoor use only in a non-explosive and non-corrosive atmosphere.

7.9.1 Temperature Range

Parameter	Specification
Storage	-40°C to +70°C
Operating	0°C to 40°C
Normal accuracy	18°C to 28°C ⁽¹⁾

⁽¹⁾ See section 1.8—Accuracy Chart for full specification.

7.9.2 Relative Humidity

Up to 80% non-condensing.

7.9.3 Altitude

Up to 2000m.

7.9.4 Installation Category

II in accordance with IEC664.

7.9.5 Pollution Degree

2 (mainly non-conductive).

7.9.6 Safety

Complies with the requirements of EN61010-1.

7.9.7 EMC

Complies with EN61326 for emissions and immunity.

8. THEORY REFERENCE

8.1 Abbreviations

B	Susceptance (= 1/X)	R	Resistance
C	Capacitance	X	Reactance
D	Dissipation factor (tan δ)	Y	Admittance (= 1/Z)
E	Voltage	Z	Impedance
G	Conductance (= 1/R)	ω	2π x frequency
I	Current		
L	Inductance		Subscript s (_s) = series
Q	Quality (magnification) factor		Subscript p (_p) = parallel

8.2 Formulae

$$Z = \frac{E}{I} \quad (\text{all terms complex})$$

$$Y = \frac{I}{E} = \frac{1}{Z}$$

$$Z_s = R + jX = R + j\omega L = R - \frac{j}{\omega C}$$

$$|Z_s| = \sqrt{(R^2 + X^2)}$$

$$|Z_p| = \frac{RX}{\sqrt{(R^2 + X^2)}}$$

$$Y_p = G + jB = G + j\omega C = G - \frac{j}{\omega L}$$

$$|Y_p| = \sqrt{(G^2 + B^2)}$$

$$|Y_s| = \frac{GB}{\sqrt{(G^2 + B^2)}}$$

$$\text{where} \quad X_L = \omega L \quad X_C = \frac{1}{\omega C} \quad B_C = \omega C \quad B_L = \frac{1}{\omega L}$$

$$Q = \frac{\omega L_s}{R_s} = \frac{1}{\omega C_s R_s} \quad (\text{series R, L, C values})$$

$$Q = \frac{R_p}{\omega L_p} = \omega C_p R_p \quad (\text{parallel R, L, C values})$$

$$D = \frac{G_p}{\omega C_p} = \omega L_p G_p \quad (\text{parallel G, L, C values})$$

$$D = \frac{R_s}{\omega L_s} = \omega C_s R_s \quad (\text{series R, L, C values})$$

Note : The value $Q = \frac{1}{D}$ is constant regardless of series/parallel convention

8.3 Series/Parallel Conversions

$$R_s = \frac{R_p}{(1+Q^2)} \qquad R_p = R_s(1+Q^2)$$

$$C_s = C_p(1+D^2) \qquad C_p = \frac{C_s}{(1+D^2)}$$

$$L_s = \frac{L_p}{\left(1+\frac{1}{Q^2}\right)} \qquad L_p = L_s\left(1+\frac{1}{Q^2}\right)$$

Conversions using the above formulae will be valid only at the test frequency.

8.4 Polar Derivations

$$R_s = |Z| \cos\theta \qquad G_p = |Y| \cos\theta$$

$$X_s = |Z| \sin\theta \qquad B_p = |Y| \sin\theta$$

Note that, by convention, +ve angle indicates an inductive impedance or capacitive admittance.

If capacitance is measured as inductance, the L value will be -ve.

If inductance is measured as capacitance, the C value will be -ve.

$$D = \tan \delta \quad \text{where } \delta = (90 - \theta)^\circ \quad \text{admittance measurement.}$$

$$Q = \frac{1}{\tan \delta} \quad \text{where } \delta = (90 - \theta)^\circ \quad \text{impedance measurement.}$$

9. MAINTENANCE, SUPPORT AND SERVICES

9.1 Guarantee

The equipment supplied by Wayne Kerr Electronics is guaranteed against defective material and faulty manufacture for a period of twelve months from the date of dispatch. In the case of materials or components employed in the equipment but not manufactured by us, we allow the customer the period of any guarantee extended to us.

If, within the guarantee period, any defect is discovered in the equipment in respect of material or workmanship and reasonably within our control, we undertake to make good the defect at our own expense subject to our standard conditions of sale. In exceptional circumstances and at the discretion of the service manager, a charge for labour and carriage costs incurred may be made.

Our responsibility is in all cases limited to the cost of making good the defect in the equipment itself. The guarantee does not extend to third parties, nor does it apply to defects caused by abnormal conditions of working, accident, misuse, neglect or wear and tear.

9.2 Maintenance

9.2.1 Cleaning

The body of the equipment can be cleaned with a damp lint-free cloth. Should it be required, weak detergents can be used. No water must enter the equipment. Do not attempt to wash down internal parts.

9.2.2 Safety Checks

Each year the equipment should be given a simple safety check.

9.2.2.1 Equipment required

25A ground bond tester (e.g. Megger PAT 2)

Insulation tester @ 500V DC (e.g. Megger BM 7)

9.2.2.2 Tests

- 1) **DISCONNECT THE INSTRUMENT FROM THE AC POWER SUPPLY!**
- 2) Inspect the unit and associated wiring for damage e.g. dents or missing parts which might impair the safety or function of the equipment. Look for any signs of overheating or evidence that objects might have entered the unit.
- 3) **Ground Bond:** Ensure that 25A DC can flow from exposed metal parts of the unit (not BNC connector outers) to ground with an impedance of less than 100mΩ.
- 4) **Insulation Test:** Connect the Live and Neutral of the power cable together and test the insulation between this point and the ground at 500V DC. Readings greater than 1MΩ are acceptable.

9.3 Support and Service

In the event of difficulty, or apparent circuit malfunction, it is advisable to contact the service department or your local sales engineer or agent (if overseas) for advice before attempting repairs.

For repairs and recalibration it is recommended that the complete instrument be returned to one of the following:

<p>UK Wayne Kerr Electronics Vinnetrow Business Park Vinnetrow Road Chichester West Sussex PO20 1QH</p> <p>Tel: +44 (0)1243 792200 Fax: +44 (0)1243 792201</p> <p>Email: service@wayne-kerr.co.uk</p>	<p>USA Wayne Kerr Electronics Inc. 165L New Boston Street Woburn MA 01801-1744</p> <p>Tel: 781 938 8390 Fax: 781 933 9523</p> <p>Email: sales@waynekerrusa.com</p>	<p>Asia Wayne Kerr Asia A604 Pengdu Building, Guimiao Road, Nanshan District, Shenzhen, Guangdong China</p> <p>Tel: +86 86 138 2525 7230 Fax: +86 755 2652 3875</p> <p>Email: service@waynekerr.com</p>
<p>Europe Wayne Kerr Europe GmbH Märkische Str. 38 - 40 58675 Hemer Germany</p> <p>Tel: +49 (0) 2372 557 870 Fax: +49 (0) 2372 557 8790</p> <p>E-mail: info@waynekerr.de</p>	<p>India Wayne Kerr Electronics Pvt Ltd FF-73, Amrit Plaza Commercial Complex B Block, Surya Nagar Ghaziabad (UP) India</p> <p>Tel: +91 (0) 12 0262 9612 Fax: +91 (0) 12 0262 9613</p> <p>E-mail: waynekerrindia@gmail.com</p>	<p>Taiwan Wayne Kerr Electronics Corporation No228-21, Sec 2, Bei Hsin Rd Hsin Tien City Taipei 231 Taiwan</p> <p>Tel: +886 (2) 2915 8990 Fax: +886 (2) 2915 5775</p> <p>E-mail: sales@waynekerrtest.com.tw</p>

When returning the instrument please ensure adequate care is taken with packing and arrange insurance cover against transit damage or loss. If possible re-use the original packing box.