

WT500

Power Analyzer

Power Analyzer WT500



- Simultaneous measurement of voltage, current, power, and harmonics
- High-speed data updating (100 ms)
- Display of numerical values, waveforms and trends
- Measurement of bought and sold watt hours
- Easy setup and operation

Current Range

0.5 to 40 A

Voltage Range

15 to 1000 V

Basic Power Accuracy

0.2%

Frequency range

DC 0.5 Hz to 100 kHz



(WT500)

Bulletin 7602-00E

Compact and easy to use. The Power Analyzer for the renewable energy generation

Power Analyzer WT500

The WT500 Power Analyzer features a color TFT and compact body that enables single-phase and three-phase power measurement, achieving $\pm 0.1\%$ basic accuracy, maximum input of 1000 Vrms, 40 Arms and a measurement bandwidth of 100 kHz.

Key layout offers intuitive control

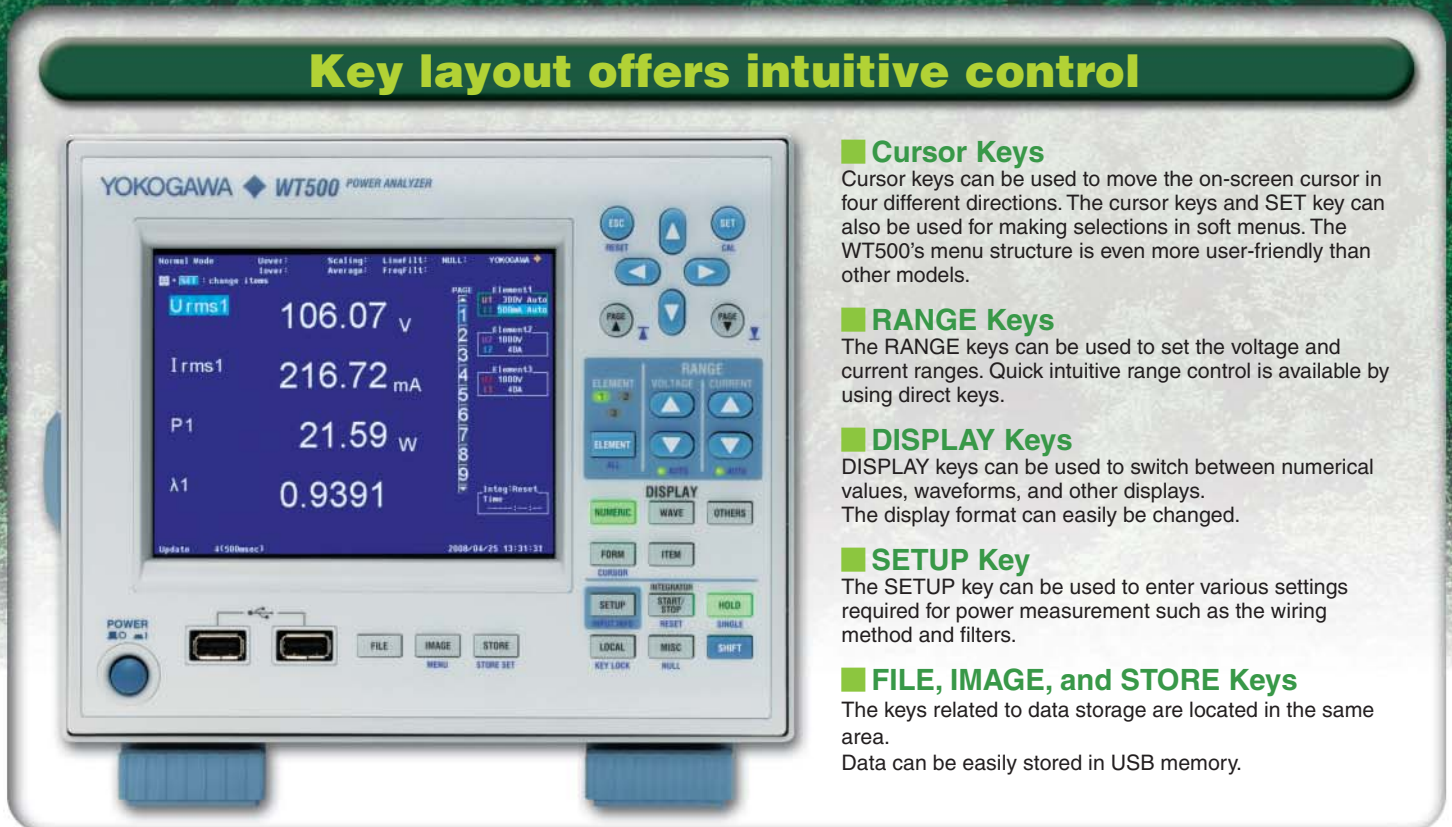

Cursor Keys

Cursor keys can be used to move the on-screen cursor in four different directions. The cursor keys and SET key can also be used for making selections in soft menus. The WT500's menu structure is even more user-friendly than other models.

RANGE Keys

The RANGE keys can be used to set the voltage and current ranges. Quick intuitive range control is available by using direct keys.

DISPLAY Keys

DISPLAY keys can be used to switch between numerical values, waveforms, and other displays. The display format can easily be changed.

SETUP Key

The SETUP key can be used to enter various settings required for power measurement such as the wiring method and filters.

FILE, IMAGE, and STORE Keys

The keys related to data storage are located in the same area. Data can be easily stored in USB memory.

Features

- **Simultaneous measurement of DC and AC signals**
Evaluation of DC/AC signal conversion technology is critical in the renewable energy market. With input from 2 or more elements, the WT500 can measure DC and AC signals simultaneously and calculate input-to-output efficiency.
- **Separate integration functions for charge/discharge and bought/sold power**
The WT500 is equipped with integration functions that can not only evaluate charge and discharge current such as from secondary cells, but also bought and sold power in photovoltaic power generation systems.
- **Saving measured data directly to USB memory**
Measured data can be saved in CSV format directly to USB memory.
- **Easy setup with cursor keys**
Menu-type screen offers intuitive settings.
- **Simultaneous measurement of normal data and harmonic data with the harmonic measurement, /G5 option**
Voltage RMS, current RMS, power values, and harmonic components up to the 50 order can be measured simultaneously.
- **WT series for power evaluation of energy-saving equipment**
The WT series have been used as powermeters for Green IT, Energy Star, CO₂ reduction and other energy-saving equipment. The WT series—including the WT500—supports your power evaluation needs.

Features

- Standard feature
- Option
- Software (sold separately)

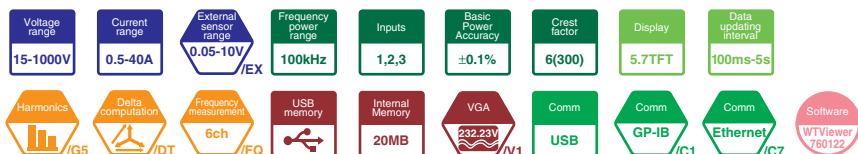

FUNCTIONS

Newly Designed Architecture

Intuitive control by using cursor keys in four different directions.
To reduce setting errors, menus display settings in order of relative importance in order.

New!



Example of voltage range setting

Measured Value Direct Save Function

Two USB ports for peripherals are installed for direct data saving (up to 1 G byte) in USB memory at shortest intervals. The saved data can be opened in applications such as Excel.

New!

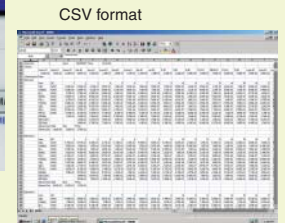

* Excel is a registered trademark of Microsoft Corporation in the U.S.A.

A Variety of Display Formats

In addition to numerical data, the WT500 can display input signal waveforms and trends (time variation of numerical data). Also bar graph display and vector display are available with the harmonic measurement (/G5) option.

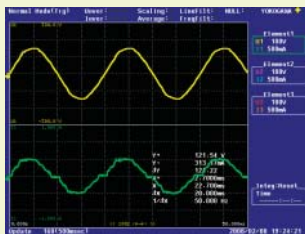

Waveform *1

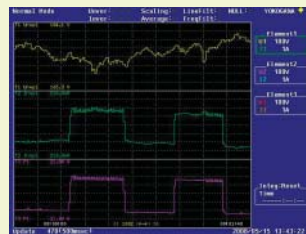

Trend



Vector *2 (/G5 option is required)

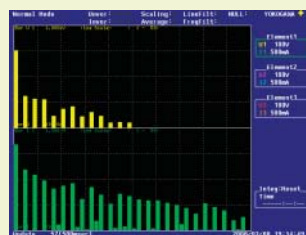

Bar graph (/G5 option is required)

*1 Waveforms of up to approximately 5 kHz can be displayed.

*2 Excludes single-phase models.

Split screen display for numerical values and waveforms is not available.

Simple Setting and Display of Efficiency

Two efficiency calculations can be set by selecting input elements or output elements from a list.

Example: $\eta_1 = \frac{P\Sigma}{P1} \times 100\%$
 $\eta_2 = \frac{P\Sigma}{P2} \times 100\%$

USB Memory Storage Function

Only necessary items within the measured data like voltage, current, and power can be saved in USB memory in binary or CSV format (up to 1 GB).

Files saved in CSV format can be opened in general-purpose applications such as Excel to allow displaying of data in graphs.



Variety of Integration Functions

In addition to integration functions of active power (WP), current (q), reactive power (WQ), and apparent power (WS), a new feature provides measurement of bought and sold watt hours. Also, average active power can be calculated over an integration interval.

This feature is useful for evaluating the power consumed by intermittent-control instruments in which the power value fluctuates. Average active power is calculated by using user-defined settings.

$$\text{Average active power} = \frac{\text{Integration power (WP)}}{\text{Elapsed time (H)}}$$

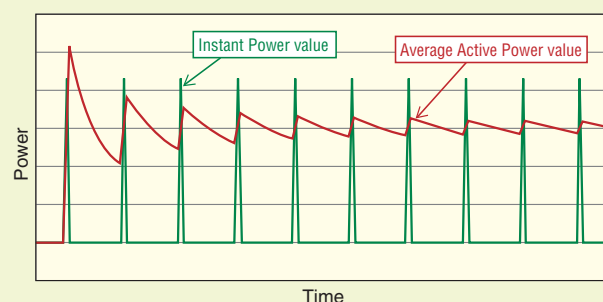

APPLICATIONS

Power Measurement for Renewable Energy

Photovoltaic power generation systems have been a focus of attention under the backdrop of the prevention of global warming.

Thermal power generation and other forms of power based on the limited resources of oil and coal release environmentally harmful CO₂, the main cause of global warming. On the other hand, because photovoltaic power generation does not release CO₂, it is considered to be an important renewable energy resource for the future. The WT500 is capable of evaluating voltage, current, and power conversion efficiency by measuring DC signals and AC signals generated by photovoltaic power, a renewable energy source.

Measurements of photovoltaic power consumption and power conversion efficiency

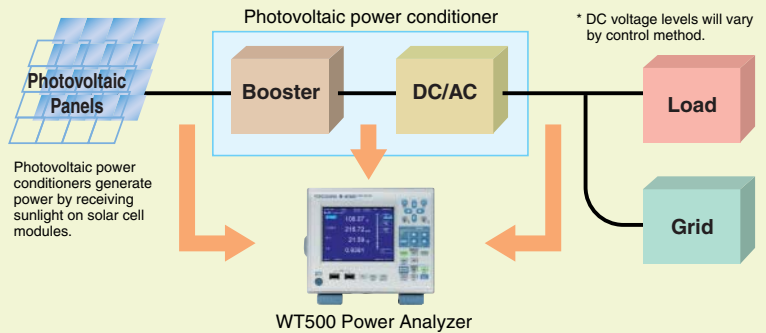

Industry is moving ahead with aggressive energy-savings and usage of renewable energy. Japan in particular has been actively developing equipment for photovoltaic power generation systems. The WT500 measures power consumption of "sold power," which supplies photovoltaically generated power to interconnected systems, and "bought power" (purchases of electricity) and simultaneously displays data of bought/sold power, consumed/regenerated energy, and other data for energy-saving monitoring.

Measurement of power conditioned and bought for home electronics

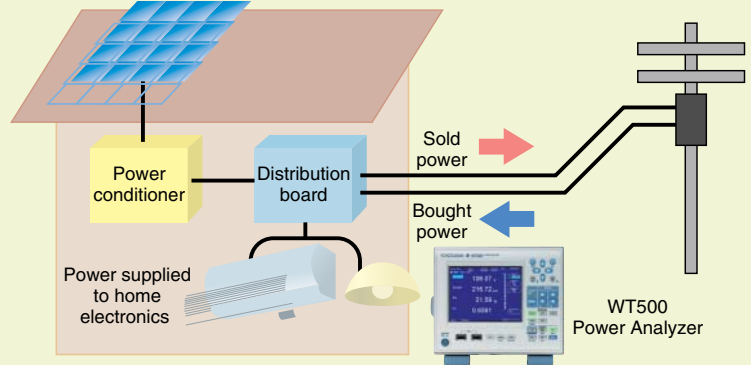

Large Current Measurements for Electrical Appliances

In recent years, the "all-electric lifestyle" of household electronics such as kitchen appliances and hot water heaters has grown in popularity, and there is increased demand for Induction Heating Cookers and other Electrical Appliances that are promoted as being safer than gas-operated stoves. A large amount of current is applied and converted to heat in order to increase the output of IH cooking heaters. The WT500 can measure voltage, current, power, and total harmonic distortion (THD) by inputting the large current (up to 40 A) flowing to the IH cooking heater, without the need for a current sensor. Measurements can be taken faster, allowing for high speed acquisition of power data on manufacturing lines.

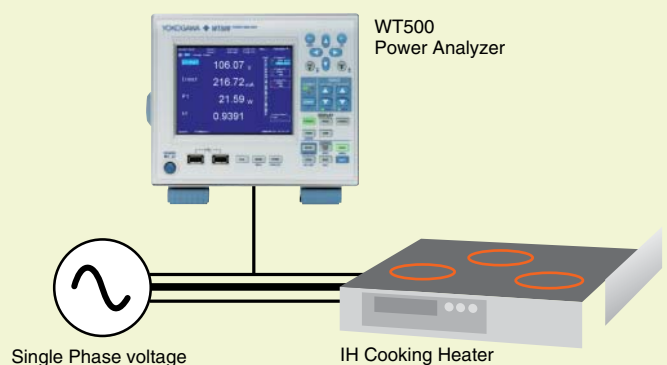

Evaluation and Testing of Home Electronics

Power consumption reduction measures have been adopted in consumer appliances such as air conditioners and washing machines due to implementation of Energy Star. Control methods are used in home electronics in which consumed current is precisely controlled to reduce power consumption. The WT500 provides measurement of the fluctuating power consumption in these appliances.

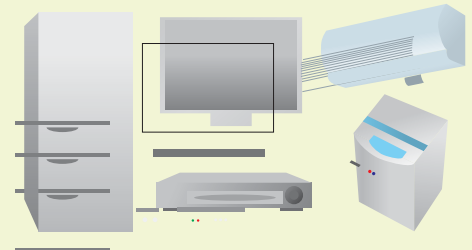

APPLICATIONS

Measuring Power Consumption of Various Motor Loads

Various industrial motor & pump and air-conditioning fans are used in factories and other such locations. The revolution speed of these motor & pump has to be controlled in order to save energy, therefore many inverter-driven motor & pump are used. The WT500 not only measures variation of voltage, current and power to evaluate performance of these motor & pump, but also enables you to examine energy efficiency by measuring integrated power.

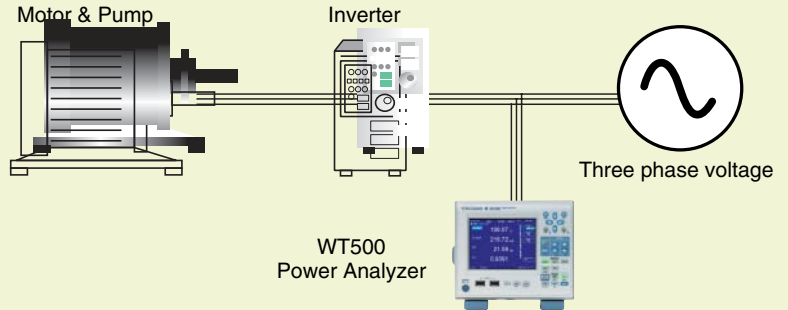

Power Quality Evaluation and Testing of UPS (Uninterruptible Power Supplies)

Uninterruptible Power Supplies (UPS) are systems that provide stable supplies of power at all times even during power failures such as power outages, instantaneous power failures, voltage fluctuations, and frequency changes. As UPS performance tests, the WT500 can calculate input-to-output efficiency, power output, frequency, and distortion factor.

Note: The standard model can measure up to two frequencies.

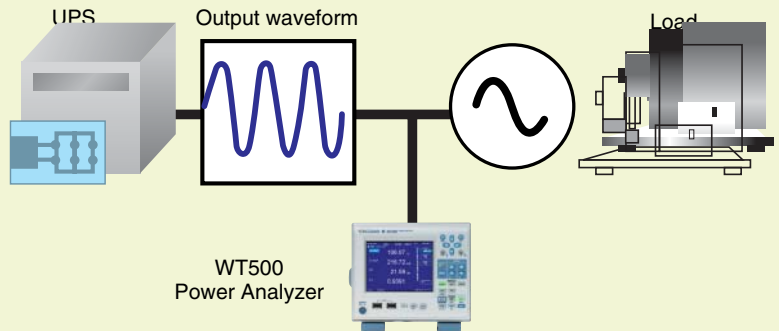

SOFTWARE

WTViewer 760122

WTViewer is a software program that reads measured numerical, waveform, and harmonic data. Data can be transferred to a personal computer via GP-IB, Ethernet, or USB communications to display and store numeric or waveform data. A communications option can be installed in the WT500 as needed.

LabVIEW Drivers

Data acquisition possible using LabVIEW. LabVIEW drivers can be downloaded from our Web site. (Free)

Communication Interface: USB, GP-IB(C1), Ethernet(C7)

Numerical Data Display

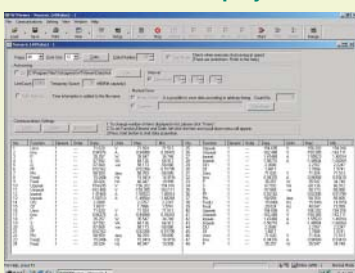

Measured data of input elements 1 to 3, and PΣ can be displayed on the PC screen via communication.

*Picture is a sample of WT3000

Waveform Display

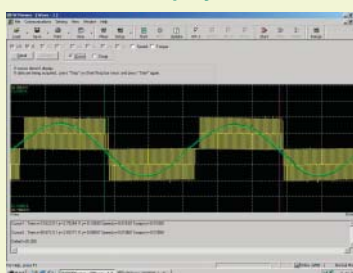

Voltage and current waveforms can be monitored on the PC screen.

You can confirm the voltage and current waveform shapes, waveform distortion, and other phenomena.

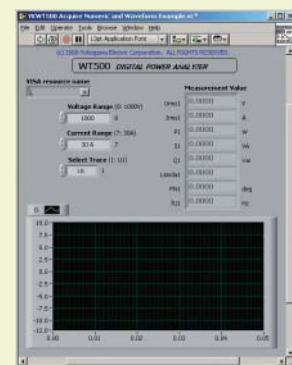

* LabVIEW is a registered trademark of NATIONAL INSTRUMENTS Corporation in the U.S.A.

OPTIONS

GP-IB Communication (/C1)

GP-IB communication enables you to control the WT500 or transfer data from a PC.

Ethernet Communication (/C7)

Data can be transferred via Ethernet* communication. It enables file transfers using an FTP server.

*100BASE-TX

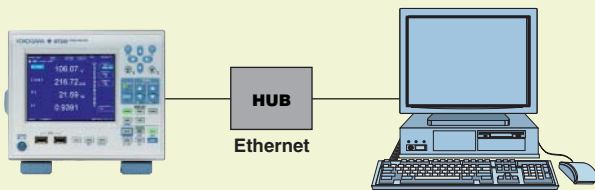

External Current Sensor Input (/EX1, /EX2, /EX3)

Current can be measured by using current clamps without disconnecting power supply wiring (voltage output type). By setting an external current sensor conversion ratio, it can support various types of current clamp-on probes.

VGA Output (/V1)

By connecting to a monitor, you can create large displays of numerical values and waveforms. This function is convenient for simultaneously confirming data on multiple monitors, or to check data remotely.

Harmonic Measurement (/G5)

This function enables simultaneous measurement of normal and harmonic data. Harmonic components of up to the 50th order can be measured. With the WT500 you can simultaneously confirm voltage, current, and the distortion factor (THD) as well as measure the distortion factor without switching modes.



Harmonic Dual List

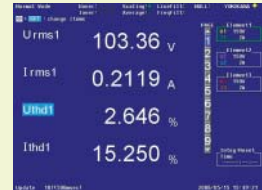

THD measurement

Delta Computation

This function allows you to calculate individual phase voltages and phase currents from the line voltages and phase currents measured in a three-phase, three-wire system. The phase voltage can be calculated from the line voltage measured with the three-phase, three-wire (3V3A) method. This is useful when you want to determine the phase voltage in a DUT with no neutral line by using the three-phase, three-wire (3V3A) method.

Note: This function cannot be installed on products with only one element.

Added Frequency Measurement (/FQ)

In addition to the standard two channels of frequency measurement on all channels, an option is available for frequency measurement on all channels. This option provides frequency measurement of voltage and current on all channels with input elements 1 through 3 installed.

This is necessary when you want to measure voltage and current frequency from the instrument's I/O as well as voltage and current frequencies of multiple items under test at the same time.

Note: This function cannot be installed on products with only one input element.

REAR PANEL

Rear Panel

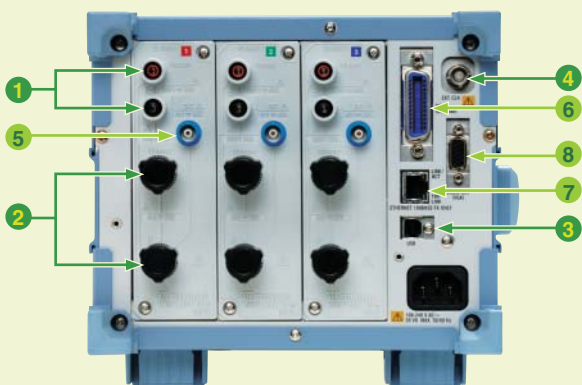

Standard feature

- 1 Voltage input terminals
- 2 Current input terminals
- 3 USB communication interface
- 4 External trigger Signal, External clock input Connector

Optional feature

- 5 External Current Sensor Input Terminals (/EX option)
- 6 GP-IB communication Interface (/C1 option)
- 7 Ethernet Port (100BASE-TX)
- 8 VGA Output (/V1 option)

ACCESSORIES

Current Sensor

Current Transducer

Clamp on Probe



CT60/CT200/CT1000

Current Sensors

- DC-800 kHz/60 Apk, DC-500 kHz/200 Apk, DC-300 kHz/1000 Apk
- Wide dynamic range: $\pm 0-1000$ A (DC)/1000 A peak (AC)
- Wide measurement frequency range: DC and up to 800 kHz
- High-precision fundamental accuracy: $\pm(0.05\%$ of reading + 30 μ A)
- ± 15 V DC power supply, connector, and load resistor required.

For detailed information, see Current Sensors & Accessories Catalog Bulletin CT1000-00E.

*751521/751523 and CT series do not conform to CE Marking.



751574

Current Transducer DC to 100 kHz/600 Apk

- Wide measurement frequency range: DC and up to 100 kHz (-3 dB)
- High-precision fundamental accuracy: $\pm(0.05\%$ of reading + 40 μ A)
- Wide dynamic range: 0-600 A (DC)/600 A peak (AC)
- ± 15 V DC power supply, connector, and load resistor required.

For detailed information, see Power Meter Accessory Catalog Bulletin 7515-52E.



751552

Current Clamp on Probe AC 1000 Arms (1400 Apeak)

- Measurement frequency range: 30 Hz to 5 kHz
- Basic accuracy: $\pm 0.3\%$ of reading
- Maximum allowed input: AC 1000 Arms, max 1400 Apk (AC)
- Current output type: 1 mA/A

A separately sold fork terminal adapter set (758921), measurement leads (758917), etc. are required for connection to WT3000. For detailed information, see Power Meter Accessory Catalog Bulletin 7515-52E.

Adapters and Cables

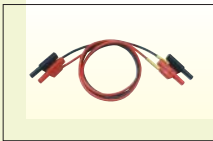

758917

Measurement leads

Two leads in a set. Use 758917 in combination with 758922 or 758929. Total length: 75 cm. Rating: 1000 V, 32 A



758922

Small alligator adapters

For connection to measurement leads (758917). Two in a set. Rating: 300 V



758929

Large alligator adapters

For connection to measurement leads (758917). Two in a set. Rating: 1000 V



758923*1

Safety terminal adapter set (spring-hold type) Two adapters in a set.



758931*1

Screw-fastened adapters. Two adapters in a set. 1.5 mm Allen wrench included for tightening.



758921

Fork terminal adapter Two adapters (red and black) to a set. Used when attaching banana plug to binding post.



701959

Safety mini-clip set (hook Type) 2 pieces (red and black) in one set. Rating 1000 V



758924

Conversion adapter For conversion between male BNC and female banana plug



366924/25*2

BNC cable (BNC-BNC 1 m/2 m) For connection to simultaneously measurement with 2 units, or for input external trigger signal.

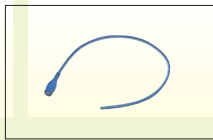

89284LK*3

External Sensor Cable For connection the external input of the WT500 to current sensor. Length: 50 cm

Due to the nature of this product, it is possible to touch its metal parts. Therefore, there is a risk of electric shock, so the product must be used with caution.

*1 Maximum diameters of cables that can be connected to the adapters
758923 core diameter: 2.5 mm or less; sheath diameter: 4.8 mm or less
758931 core diameter: 1.8 mm or less; sheath diameter: 3.9 mm or less

*2 Use with a low-voltage circuit (42 V or less)

*3 The coax cable is simply cut on the current sensor side. Preparation by the user is required.

Typical Voltage/Current Connections

Measurement using current sensor

Connection example

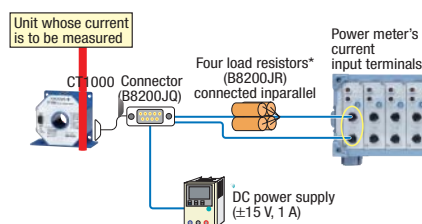

Measurement using clamp-on probe

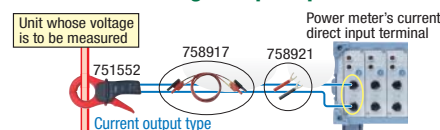

Current measurement using direct input terminal

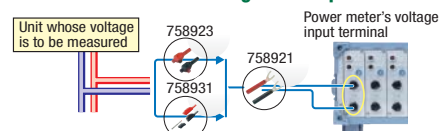

Measurement using voltage input terminal

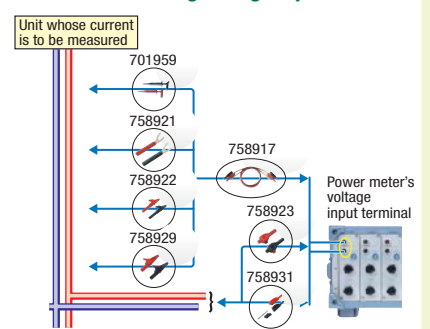

* A burden resistor is required for the CT1000, CT200, CT60, and 751574.

Comparison of Specifications and Functions in WT500, Other WT Series Models

Comparison among WT series

		WT500	WT210/WT230	WT1800	WT3000	
Range	Basic power accuracy (50/60 Hz)	0.1% of reading + 0.1% of range	0.1% of reading + 0.1% of range	0.1% of reading + 0.05% of range	0.02% of reading + 0.04% of range	
	Measurement power bandwidth	DC, 0.5 Hz to 100 kHz	DC, 0.5 Hz to 100 kHz	DC, 0.1 Hz ~ 1 MHz	DC, 0.1 Hz to 1 MHz	
	Input elements	1, 2, 3	(WT210), 2&3 (WT230)	1, 2, 3, 4, 5, 6	1, 2, 3, 4	
	Voltage range (Crest factor=3)	15/30/60/100/150/300/600/1000 [V]	15/30/60/120/200/300/600 [V]	1.5/3/6/10/15/30/60/100/150/300/600/1000 [V]	15/30/60/100/150/300/600/1000 [V]	
	Current range (Crest factor=3)	Direct input	0.5/1/2/5/10/20/40 [A]	5 m/10 m/20 m/50 m/0.1/0.2/0.5/1/2/5/10/20 [A] (WT210) 0.5/1/2/5/10/20 [A] (WT230)	Select from 10 m/20 m/50 m/100 m/200 m/500 m/1/2/5 [A] or 1/2/5/10/20/50 [A]	0.5/1/2/5/10/20/30 [A]
		External sensor input	50 m/100 m/200 m/500 m/1/2/5/10 [V] (opt.)	50 m/100 m/250 m [V] or 2.5/5/10 [V] (opt.)	50 m/100 m/250 m/500 m/1/2.5/5/10 [V]	50 m/100 m/200 m/500 m/1/2/5/10 [V]
Guaranteed accuracy range for voltage and current ranges		1% to 110%	1% to 130%	1% to 110%	1% to 130%	
Main measurement parameters: Voltage, current, active power, reactive power, apparent power, power factor, phase angle, peak voltage, peak current, crest factor						
Measurement parameters	Peak hold (instantaneous maximum value hold)	✓	✓	✓	✓	
	MAX hold	✓	✓	✓	✓	
	Voltage RMS/MEAN simultaneous measurement	✓	✓	✓	✓	
	RMS/MEAN/AC/DC simultaneous measurement	✓	✓	✓	✓	
	Average active power	✓ (user-defined function)	✓	✓ (user-defined function)	✓ (user-defined function)	
	Active power amount (WP)	✓	✓	✓	✓	
	Apparent power amount (WS)	✓	✓	✓	✓	
	Reactive power amount (WQ)	✓	✓	✓	✓	
	Frequency	2 channels (up to 6 channels with option /FQ)	selected voltage or current (one)	3 channels (up to 12 channels with option /FQ)	2 channels (up to 8 channels with option /FQ)	
	Efficiency	✓	✓	✓	✓	
	Motor evaluation			Torque and rotational velocity input (opt.)	Torque, rotating speed input (motor version) (opt.)	
	FFT spectral analysis			(/G6) (opt.)	(/G6) (opt.)	
	User-defined functions	✓ (8 functions)		✓ (20)	✓ (20 functions)	
	Display	Display	5.7-inch TFT color LCD	7-segment display	8.4-inch TFT color LCD (XGA)	8.4-inch TFT color LCD
Display format		Numerical values, waveforms, trends, bar graphs, vectors	Numerical values (3)	Numerical values, waveforms, trends, bar graphs, vectors	Numerical values, waveforms, trends, bar graphs, vectors	
Sampling frequency		Approximately 100 kS/s	Approximately 50 kS/s	Approximately 2 MS/s	Approximately 200 kS/s	
Measurement functions	Harmonic measurement	✓ (/G5) (opt.)	✓ (opt.)	(/G5)(opt.)	(/G6) (opt.)	
	Dual Harmonic Measurement			(/G6)(opt.)		
	IEC standards-compliant harmonic measurement				(/G6) (opt.)	
	Flicker measurement				(/FL) (opt.)	
	Cycle by cycle				(/CC) (opt.)	
	Delta calculation function	✓ (/DT) (opt.)		(/DT)(opt.)	(/DT) (opt.)	
	DA output		4 channels (WT210) (opt.), 12 channels (WT230) (opt.)	20 channels (/DA) (opt.)	20 channels (/DA) (opt.)	
	Synchronized operation	✓		✓	✓	
	Storage (internal memory for storing data)	Approximately 20 MB (Internal Memory) Max. 1 GB (direct memory to USB)	MAX.600 sample (WT210), MAX.300 sample (WT230)	Approximately 32 MB	approximately 30MB	
	Other features	Interfaces	USB, GP-IB (/C1 opt.), Ethernet (/C7 opt.), VGA output (/V1)(opt.)	GP-IB; or RS-232; (opt.) (WT210) GP-IB; or RS-232 (WT230)	GPIB, USB, Ethernet, RGB output (/V1)	GP-IB; RS-232 (/C2) (opt.); USB (/C12) VGA output (/V1) (opt.); Ethernet (/C7) (opt.)
Data updating interval		100 m/200 m/500 m/1/2/5 [S]	100 m/250 m/500 m/1/2/5 [S]	50 m/100 m/250 m/500 m/1/2/5/10/20 [S]	50 m/100 m/250 m/500 m/1/2/5/10/20 [S]	
Removable storage		USB		○ USB	PC card interface; USB (/C5) (opt.)	
Printer				Built-in printer (front side) (opt.)	Built-in printer (front side) (/B5) (opt.)	

There are limitations on some specifications and functions. See the individual product catalogs for details.

CHARACTERISTICS

Example of basic characteristics showing the WT500's high precision

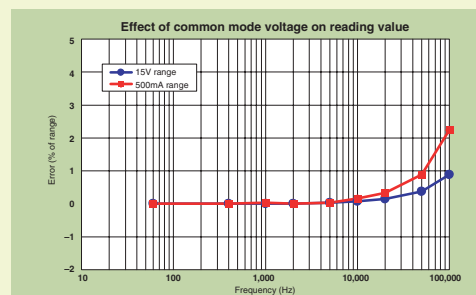
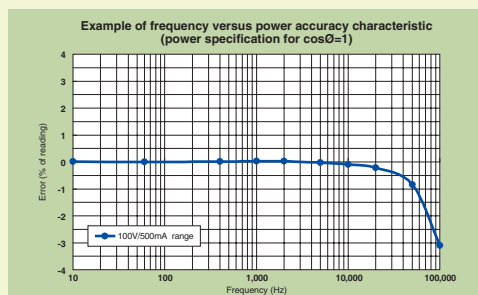
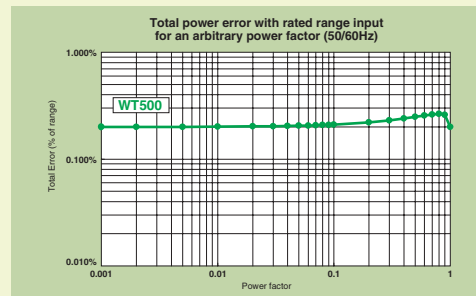
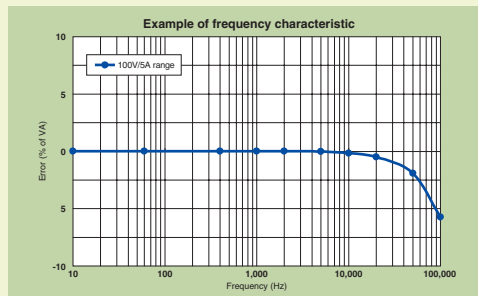

WT500 SPECIFICATION

WT500 Specifications

Inputs	
Item	Specification
Input terminal type	Voltage Plug-in terminal (safety terminal) Current • Direct input: Large binding post • External sensor input: Insulated BNC connector
Input type	Voltage Floating input, resistive potential method Current Floating input, shunt input method
Measurement range	Voltage 15 V, 30 V, 60 V, 100 V, 150 V, 300 V, 600 V, 1000 V (for crest factor 3) 7.5 V, 15 V, 30 V, 50 V, 75 V, 150 V, 300 V, 500 V (for crest factor 6) Current • Direct input 500 mA, 1 A, 2 A, 5 A, 10 A, 20 A, 40 A (for crest factor 3) 250 mA, 500 mA, 1 A, 2.5 A, 5 A, 10 A, 20 A (for crest factor 6) • External sensor input 50 mV, 100 mV, 200 mV, 500 mV, 1 V, 2 V, 5 V, 10 V (for crest factor 3) 25 mV, 50 mV, 100 mV, 250 mV, 500 mV, 1 V, 2.5 V, 5 V (for crest factor 6)
Instrument loss (input impedance)	Voltage Approximately 2 MΩ, 13 pF Current • Direct input: Approximately 5 mΩ + approximately 0.1 μH • External sensor input: Approximately 100 kΩ
Instantaneous maximum allowable input (20 m second or less)	Voltage Peak voltage of 2.8 kV or RMS of 2 kV, whichever is lower Current • Direct input: Peak current of 450 A or RMS of 300 A, whichever is lower • External sensor input: Peak not to exceed 10 times the range
Instantaneous maximum allowed input (1 second or less)	Voltage Peak voltage of 2 kV or RMS of 1.5 kV, whichever is lower Current • Direct input: Peak current of 150 A or RMS of 45 A, whichever is lower • External sensor input: Peak not to exceed 10 times the range
Continuous maximum allowed input	Voltage Peak voltage of 1.5 kV or RMS of 1 kV, whichever is lower Current • Direct input: Peak current of 100 A or RMS of 45 A, whichever is lower • External sensor input: Peak not to exceed 5 times the range
Continuous maximum common mode voltage (50/60 Hz)	1000 Vrms
Influence from common mode voltage	Apply 1000 Vrms with the voltage input terminals shorted and the current input terminals open. • 50/60 Hz: ±0.01% of range or less • Reference value up to 100 kHz ± (max. range/range) * 0.001 * f% of range or less. However, 0.01% or more. The units of f are kHz. Current Sensor Input is 10 times of above equations. The maximum rated range within equations is 1000 V or 40 A or 10V.
Line filter	Select OFF, 500 Hz, 5.5 kHz.
Frequency filter	Select OFF, or ON (Cut off frequency: 500 Hz)
A/D converter	Simultaneous voltage and current conversion and 16-bit resolution. Conversion speed (sampling rate): Approximately 10 μs. See harmonic measurement items for harmonic display.
Range switching	Can be set for each input element.
Auto range functions	Increasing range value • When the measured values of U rms and I rms exceed 110% of the range rating • When the peak value exceeds approximately 330% of the range rating (or approximately 660% for crest factor 6) Decreasing range value • When the measured values of U rms and I rms fall to 30% or less of the range rating, and Upk and Ipk are 300% or less of the lower range value (or 600% for crest factor 6)

Display	
Display	5.7-inch color TFT LCD monitor
Total number of pixels*	640 (horiz.) × 480 (vert.) dots
Waveform display resolution	501 (horiz.) × 432 (vert.) dots
Display update rate	Same as the data update rate. Exceptions are listed below. • The display update interval of numeric display (4, 8, and 16 items) is 200 ms when the data update rate is 100 ms. • The display update interval of numeric display (ALL, Single List, and Dual List) is 500 ms when the data update rate is 100 ms or 200 ms. • The display update rate of the trend display, bar graph display, and vector display is 1 s when the data update rate is 100 ms to 500 ms. • The display update interval of the waveform display is approximately 1 s when the data update rate is 100 ms to 1 s. However, it may be longer depending on the trigger setting. • At the setting of SLAVE mode, display update rate depends on the External clock. However it is adopted under faster external condition than data update rate.

* Up to 0.02% of the pixels on the LCD may be defective.

Calculation Functions

Measurement functions	Equations
WP [Wh]	Power integration $\frac{1}{N} \sum_{n=1}^N$ N: sampling times during the elapsed period Time: unit is h WPTYPE: CHARGE/DISCHARGE
WP+	WP+ is summation of product of u (n) × i(n) equation which is only positive value
WP-	WP- is summation of product of u (n) × i (n) equation which is only negative value WP is sum of WP+ and WP- WPTYPE: BOUGHT/SOLD WP+ is summation of average P which is only positive value WP- is summation of average P which is only negative value WP is sum of WP+ and WP-
	Single-phase, 3 wire 3 phase, 3 wire 3 phase, 3 wire (3 voltage 3 current) 3 phase, 4 wire
UΣ [V]	(U1+U2)/2 (U1+U2+U3)/3
IΣ [A]	(I1+I2)/2 (I1+I2+I3)/3
PΣ [W]	P1+P2 P1+P2+P3
SΣ [VA]	TYPE1 S1+S2 $\frac{\sqrt{3}}{2} (S1+S2)$ $\frac{\sqrt{3}}{3} (S1+S2+S3)$ S1+S2+S3 TYPE2 TYPE3 $\sqrt{P\Sigma^2+Q\Sigma^2}$
QΣ [var]	TYPE1 Q1+Q2 Q1+Q2+Q3 TYPE2 $\sqrt{S\Sigma^2-P\Sigma^2}$ TYPE3 Q1+Q2 Q1+Q2+Q3
WPΣ [Wh]	WP1+WP2 WP1+WP2+WP3
WP+Σ [Wh]	CHARGE/DISCHARGE setting WP+1+WP+2 WP+1+WP+2+WP+3 When WPTYPE is set to SOLD/BOUGHT, only positive WPΣ value is added
WP-Σ [Wh]	CHARGE/DISCHARGE setting WP-1+WP-2 WP-1+WP-2+WP-3 When WPTYPE is set to SOLD/BOUGHT, only negative WPΣ value is added
qΣ [Ah]	q1+q2 q1+q2+q3
q+Σ [Ah]	q+1+q+2 q+1+q+2+q+3
q-Σ [Ah]	q-1+q-2 q-1+q-2+q-3
WQΣ [varh]	$\frac{1}{N} \sum_{n=1}^N Q\Sigma(n) \times \text{Time}$ QΣ(n) is the nth reactive power Σ function, and N is the number of data updates. Unit of Time is h.
WSΣ [VAh]	$\frac{1}{N} \sum_{n=1}^N S\Sigma(n) \times \text{Time}$ SΣ(n) is the nth apparent power Σ function, and N is the number of data updates. Unit of Time is h.
λΣ	$\frac{P\Sigma}{S\Sigma}$
ØΣ [°]	$\cos^{-1} \left(\frac{P\Sigma}{S\Sigma} \right)$

Note1) The instrument's apparent power (S), reactive power (Q), power factor (λ), and phase angle (Ø) are calculated using measured values of voltage, current, and active power. (However, reactive power is calculated directly from sampled data when TYPE3 is selected.) Therefore, when distorted waveforms are input, these values may be different from those of other measuring instruments based on different measuring principals.
Note 2) The value of Q in the QS calculation is calculated with a preceding minus sign (-) when the current input leads the voltage input, and a plus sign when it lags the voltage input, so the value of QS may be negative.

η [%]	Set a efficiency calculation up to 2
User-defined functions F1-F8	Create equations combining measurement function symbols, and calculate up to eight numerical data.

Accuracy

[Conditions]
Temperature: 23±5°C, Humidity: 30 to 75%RH, Input waveform: Sine wave, Common mode voltage: 0 V, Crest factor: 3, Line filter: OFF, Frequency filter: 440 Hz ON, λ (power factor): 1, After warm-up. After zero level compensation or range value change while wired. f is frequency, 6-month
* These conditions are all accuracy condition in this section.

Accuracy ±(reading error + measurement range error) (for crest factor 3)

Frequency	Voltage	Current	Power
DC	0.1% of reading + 0.1% of range	0.1% of reading + 0.1% of range	0.1% of reading + 0.1% of range
0.5 Hz ≤ f < 45 Hz	0.1% of reading + 0.2% of range	0.1% of reading + 0.2% of range	0.3% of reading + 0.2% of range
45 Hz ≤ f ≤ 66 Hz	0.1% of reading + 0.1% of range	0.1% of reading + 0.1% of range	0.1% of reading + 0.1% of range
66 Hz < f ≤ 1 kHz	0.1% of reading + 0.2% of range	0.1% of reading + 0.2% of range	0.2% of reading + 0.2% of range
1 kHz < f ≤ 10 kHz	{0.1 + 0.05 × (f-10)}% of reading + 0.2% of range	{0.1 × f}% of reading + 0.2% of range	{0.2 + 0.1 × (f-10)}% of reading + 0.2% of range
10 kHz < f ≤ 50 kHz	{0.5 + 0.04 × (f-10)}% of reading + 0.3% of range	{1 + 0.08 × (f-10)}% of reading + 0.3% of range	{0.2 + 0.1 × (f-10)}% of reading + 0.3% of range
50 kHz < f ≤ 100 kHz	{0.5 + 0.04 × (f-10)}% of reading + 0.3% of range	{1 + 0.08 × (f-10)}% of reading + 0.3% of range	{5.1 + 0.18 × (f-50)}% of reading + 0.3% of range

- Unit of f of reading error is kHz
- External Sensor Input, add 50 μV to DC Current accuracy and add (50 μV / external sensor input rated range) × 100% of range to DC power accuracy
- Direct current input, add 500 μA to DC Current accuracy and add (500 μA / direct current input rated range) × 100% of range to DC power accuracy
- Accuracy of waveform display data, Upk and Ipk (reference value)
Voltage: Add 1.5 × √15/range rated % of range
Current: Direct-add 3 × √0.5/range rated % of range + 5 mA
External input-add 3 × √0.05/range rated % of range + 2 mV.
Effective input range is within ±300% (within ±600% for crest factor 6)
- Influenced by changes in temperature after zero level correction or range value changes.
Add 0.02% of range/°C to the voltage DC accuracy, 500 μA/°C to the current DC accuracy, 50 μV/°C to the external current DC accuracy, and influence of voltage times influence of current to the power DC accuracy.
- Influence of self heating due to current input
When the input signal is current, for AC add 0.00013 × I% of rdg, and for DC add 0.00013 × I% of rdg + 0.004 × I% mA to the current and power accuracy. I is the reading value of current (A). Please note that the influence of self-heating is present until the shunt resistance temperature drops, even when the current input value is small.
- Additions to accuracy according to the data update rate
Add 0.05% of rdg when it is 100 ms.
- Range of guaranteed accuracy by frequency, voltage, and current
All accuracies between 0.5 Hz and 10 Hz are reference values.
If the voltage exceeds 750 V at 30 kHz-100 kHz, the voltage and power values are reference values.
If the current exceeds 20 A at DC, 10 Hz-45 Hz, or 400 Hz-100 kHz; the current and power accuracies are reference values.
- Accuracy for crest factor 6: Range accuracy of crest factor 3 for two times range of crest factor 6.
- Influence of self heating due to voltage input
When the input signal is voltage, for AC add 0.0000001 × u% of reading, and for DC add 0.0000001 × u% of reading + 0.0000001 × u% of range. u is the reading value of voltage. Please note that the influence of self heating is present until the resistance temperature drops, even when the voltage input value is small.

WT500 SPECIFICATION

	Voltage/current	Power
Total power error with respect to the range for an arbitrary power factor λ (exclude $\lambda = 1$)	-	When $\lambda = 0$ Apparent power reading $\times 0.2\%$ in the 45 to 66 Hz range All other frequencies are as follows (however, these are only reference values): Apparent power reading $\times (0.2 + 0.2 \times f \text{ (kHz)})\%$ $0 < \lambda < 1$ (Power reading) \times [(Power reading Error (%)) + (power range error (%)) \times (Power range/Apparent power reading)+power reading \times (tan ϕ \times (influence when $\lambda = 0\%$))] ϕ is the phase difference of voltage and current
Influence of line filter	When cutoff frequency is 500 Hz *45 to 66 Hz: Add 0.2% of reading Under 45 Hz: Add 0.5% of reading* When cutoff frequency is 5.5 kHz *66 Hz or less: Add 0.2% of reading 66 to 500 Hz: Add 0.5% of reading*	When cutoff frequency is 500 Hz *45 to 66 Hz: Add 0.3% of reading Under 45 Hz: Add 1% of reading* When cutoff frequency is 5.5 kHz *66 Hz or less: Add 0.4% of reading 66 to 500 Hz: Add 1.2% of reading*
Lead/Lag Detection (d (LEAD) /G (LAG) of the phase angle and symbols for the reactive power Q Σ calculation) * The s symbol shows the lead/lag of each element, and "-" indicates leading.	The phase lead and lag are detected correctly when the voltage and current signals are both sine waves, the lead/lag is 50% of the range rating (or 100% for crest factor 6), the frequency is between 20 Hz and 2 kHz, and the phase angle is $\pm(5^\circ$ to $175^\circ)$ or more.	
Temperature coefficient	$\pm 0.03\%$ of reading/ $^\circ\text{C}$ at $5\text{--}18^\circ$ or $28\text{--}40^\circ\text{C}$.	
Effective input range	Udc and Idc are 0 to $\pm 110\%$ of the measurement range Urms and Irms are 1 to 110% of the measurement range (or 2% – 220% for crest factor 6) Umn and Imn are 10 to $\pm 110\%$ of the measurement range Urmn and Irmn are 10 to $\pm 110\%$ of the measurement range Power is 0 to $\pm 110\%$ for DC measurement, 1 to 110% of the voltage and current range for AC measurement, and up to $\pm 110\%$ of the power range. However, the synchronization source level falls below the input signal of frequency measurement. 110% of the voltage range rating.	
Max. display	140% of the voltage and current range rating	
Min. display	Urms, Irms, Uac and Iac are up to 0.5% relative to the measurement range (or up to 1% for a crest factor of 6). Umn, Urmn, Imn, and Irmn are up to 2% (or 4% for a crest factor of 6). Below that, zero suppress. Current integration value q also depends on the current value.	
Measurement lower limit frequency	Data update rate	100 ms 200 ms 500 ms 1 s 2 s 5 s
	Measurement lower limit frequency	25 Hz 12.5 Hz 5 Hz 2.5 Hz 1.25 Hz 0.5 Hz
Accuracy of apparent power S	Voltage accuracy + current accuracy	
Accuracy of reactive power Q	Accuracy of apparent power + $(\sqrt{1.0004 - \lambda^2} - \sqrt{1 - \lambda^2}) \times 100\%$ of range	
Accuracy of power factor λ	$\pm[(\lambda - \lambda/1.0002) + \text{Icos}\phi - \text{cos}(\phi + \sin^{-1}(\text{influence of power factor of power when } \lambda = 0\%/100))] \pm 1$ digit when voltage and current is at rated input of the measurement range. ϕ is the phase difference of voltage and current.	
Accuracy of phase difference ϕ	$\pm[10 - \text{cos}^{-1}(\lambda/1.0002)] + \sin^{-1}(\text{influence of power factor of power when } \lambda = 0\%/100) / 100$ } deg ± 1 digit when voltage and current is at rated input of the measurement range	
One-year accuracy	Add the accuracy of reading error (Six-month) $\times 0.5$ to the accuracy six-month	

Functions

Measurement method	Digital multiplication method
Crest factor	3 or 6 (when inputting rated values of the measurement range), and 300 relative to the minimum valid input.
Measurement period	Interval for determining the measurement function and performing calculations. Period used to determine and compute the measurement function. • The measurement period is set by the zero crossing of the reference signal (synchronization source) (excluding watt hour WP as well as ampere hour q during DC mode). • For harmonic measurement (/G5 option), the measurement period is from the beginning of the data update interval to 1024 points at the harmonic sampling frequency.
Wiring	You can select one of the following five wiring settings. 1P2W (single phase, two-wire), 1P3W (single phase, 3 wire), 3P3W (3 phase, 3 wire), 3P4W (3 phase, 4 wire), 3P3W(3V3A) (3 phase, 3 wire, 3 volt/3 amp measurement). However, the number of available wiring settings varies depending on the number of installed input elements. Up to four, or only one, two, or three wiring settings may be available.
Scaling	When inputting output from external current sensors, VT, or CT, set the current sensor conversion ratio, VT ratio, CT ratio, and power coefficient in the range from 0.0001 to 9999.9999.
Input filter	Line filter or frequency filter settings can be entered.
Averaging	• The average calculations below are performed on the normal measurement parameters of voltage U, current I, power P, apparent power S, reactive power Q, Power factor λ and phase angle ϕ are determined by calculating the average of P and S. Select exponential or moving averaging. • Exponential average Select an attenuation constant of 2, 4, 8, 16, 32, or 64. • Moving average Select the number of averages from 8, 16, 32, or 64. • The average calculations below are performed on the harmonic display items of voltage U, current I, power P, apparent power S, reactive power Q, Power factor λ is determined by calculating the average of P and Q. Only exponential averaging is performed. Select an attenuation constant of 2, 4, 8, 16, 32 or 64 Select 100 ms, 200 ms, 500 ms, 1 s, 2 s, or 5 s.
Data update rate	At maximum, two times the data update rate (only during numerical display)
Response time	

Hold	Holds the data display.
Single	Executes a single measurement during measurement hold.
Zero level compensation/Null	Compensates the zero level. the range: $\pm 10\%$ of range

Integration

Mode	Select a mode of Manual, Standard, Continuous (repeat), Real Time Control Standard, or Real Time Control Continuous (Repeat).
Timer	Integration can be stopped automatically using the integration timer setting. 0000 h 00 m 00 s–10000 h 00 m 00 s
Count over	If the count over integration time reaches the maximum integration time (10000 hours), or if the integration value reaches max/min display integration value (± 999999 MWh or ± 999999 Mah), the elapsed time and value is saved and the operation is stopped.
Accuracy	Power: $\pm(\text{power accuracy} + 0.02\%$ of WS) Current: $\pm(\text{current accuracy} + 0.02 \times \text{elapsed time (h) \% of range})$ (when select dc) $\pm(\text{current accuracy} + 0.02\%$ of reading) (when selected others) It does not sample for approximately 70 μs at each data update. The period is compensated.
Time accuracy	$\pm 0.02\%$ of reading

Display

• Numerical display function	
Display resolution	60000
Number of display items	Select 4, 8, 16 matrix, all, single list, or dual list.
• Waveform display items	
No. of display rasters	501
Display format	Peak-peak compressed data
Time axis	Range from 1 ms – 500 ms/div. However, it must be 1/10 th of the data update rate.
Sample rate	Approximately 100 ks/s
Triggers	
Trigger Type	Edge type
Trigger Mode	Select Auto or Normal. Triggers are turned OFF automatically during integration.
Trigger Source	Select voltage, current, or external clock for the input to each input element.
Trigger Slope	Select (Rising), (Falling), or (Rising/Falling).
Trigger Level	When the trigger source is the voltage or current input to the input elements. Set in the range from the center of the screen to $\pm 100\%$ (top/bottom edge of the screen). Setting resolution: 0.1% When the trigger source is Ext Clk, TTL level.
Vertical axis Zoom	Voltage and current input to the waveform vertical axis zoom input element can be zoomed along the vertical axis. Set in the range of 0.1 to 100 times.
ON/OFF	ON/OFF can be set for each voltage and current input to the input element.
Format	You can select 1, 2, 3 or 4 splits for the waveform display.
Interpolation	Select dot or linear interpolation.
Graticule	Select graticule or cross-grid display.
Other display ON/OFF	Upper/lower limit (scale value), and waveform label ON/OFF.
Cursor measurements	When you place the cursor on the waveform, the value of that point is measured.
Zoom function	No time axis zoom function
	* Since the sampling frequency is approximately 100 kHz, waveforms that can be accurately reproduced are those of about 5 kHz.

• Vector Display/Bar Graph Display (/G5 option is required)	
Vector display	Vector display of the phase difference in the fundamental waves of voltage and current.
Bar graph display	Displays the size of each harmonic in a bar graph.
• Trend display	
Number of measurement channels	Up to 8 parameters
	Displays trends (transitions) in numerical data of the measurement functions in a sequential line graph.
	Two windows can be selected (from numerical display, Not available)
• Simultaneous display	

Storage

• Saving and Loading Data	Settings, waveform display data, numerical data, and screen image data can be saved to media*. Saved settings can be loaded from a media*. *USB memory
---------------------------	--

Store function

Internal memory size	Approximately 20 MB
Store interval (waveform OFF)	Maximum 100 msec to 99 hour 59 minutes 59 seconds.
Guideline for Storage Time (Waveform Display OFF, Integration Function OFF)	

Number of measurement channels	Measured Items (Per CH)	Storage Interval	Storable Amnt. of Data
1 ch	3	100 ms	Approx. 40 hr
1 ch	10	1 sec	Approx. 120 hr
3 ch	10	100 ms	Approx. 4 hr
3 ch	20	1 sec	Approx. 20 hr

Note: Depending on the user-defined math, integration, and other settings, the actual measurement time may be shorter than stated above.
Store interval to memory depends on number of stored data and kind of the media

Added Frequency Measurement (/FQ Optional)

Device under measurement	Select up to two frequencies of the voltage or current input to the input elements for measurement. If the frequency option (/
--------------------------	--

WT500 SPECIFICATION

Measurement method	FQ) is installed, the frequencies of the voltages and currents being input to all input elements can be measured.
Measurement range	Reciprocal method Data Update Rate 100 ms 200 ms 500 ms 1 s 2 s 5 s
Accuracy	Measuring Range 25 Hz ≤ f ≤ 100 kHz 12.5 Hz ≤ f ≤ 100 kHz 5 Hz ≤ f ≤ 100 kHz 2.5 Hz ≤ f ≤ 100 kHz 1.5 Hz ≤ f ≤ 50 kHz 0.5 Hz ≤ f ≤ 20 kHz ±0.06% of reading When the input signal levels are greater than or equal to 25 mV (current external sensor input) and the signal is greater than or equal to 30% (0.1 Hz–440 Hz, frequency filter ON), of the measurement range. However, when the measuring frequency is smaller or equal to 2 times of above lower frequency, the input signal is greater than or equal to 50%. Add 0.05% of reading when current external input is smaller than or equal to 50 mV input signal level for each is double for crest factor 6.
Max. display resolution	99999
Min. frequency resolution	0.0001 Hz
Frequency Filter	Select ON/OFF

Delta Calculation Function (/DT Optional)

Item	Delta Calculation Setting	Symbols and Meanings
Voltage	difference	ΔU1: Differential voltage determined by computed u1 and u2
	3P3W→3V3A	ΔU1: Line voltage determined in the calculation for a 3 phase 3 wire connection
	DELTA→STAR	ΔU1, ΔU2, ΔU3: Phase voltage determined in the calculation for 3 phase 3 wire (3V3A) connection
	STAR→DELTA	ΔU1, ΔU2, ΔU3: Line voltage determined in the calculation for a 3 phase 4 wire connection
Current	difference	ΔI1: Differential current determined by computation
	3P3W→3V3A	Phase current that are not measured can be computed
	DELTA→STAR	Neutral line current
	STAR→DELTA	Neutral line current

RGB Video Signal (VGA) Output Section (/V1 Optional)

Connector type	15-pin D-Sub (receptacle)
Output format	VGA compatible

Harmonic Measurement Function (/G5 Optional)

Measure source	All Installed Elements
Method	PLL synchronization
Frequency range	PLL source of the fundamental frequency is in the range 10 Hz–1.2 kHz.
PLL source	Select voltage, current, or external clock for each input element.
Data length for FFT	32 bits
Window function	Rectangular
Anti-aliasing filter	Set using a line filter (5.5 kHz or OFF)

Sample rate (sampling frequency), window width, and upper limit of analyzed orders for PLL synchronization.

- During Harmonic Display

Fundamental Frequency	Sample Rate	Window Width	Upper Limit of Analyzed orders
10 Hz to 75 Hz	f*1024	1	50
75 Hz to 150 Hz	f*512	2	32
150 Hz to 300 Hz	f*256	4	16
300 Hz to 600 Hz	f*128	8	8
600 Hz to 1200 Hz	f*64	16	4

Accuracy ±(reading error + measurement range error) (for crest factor 3)

- When Line Filter is ON (5.5 kHz)

Sampling Frequency	Voltage Current	Power
10 Hz ≤ f < 45 Hz	0.4% of reading + 0.35% of range	0.85% of reading + 0.5% of range
45 Hz ≤ f < 440 Hz	0.75% of reading + 0.35% of range	1.5% of reading + 0.5% of range
440 Hz ≤ f < 1 kHz	1.2% of reading + 0.35% of range	2.4% of reading + 0.5% of range
1 kHz ≤ f < 2.5 kHz	5% of reading + 0.35% of range	10% of reading + 0.5% of range

- When Line Filter is OFF

Sampling Frequency	Voltage	Current	Power
10 Hz ≤ f < 45 Hz	0.15% of reading + 0.35% of range	0.15% of reading + 0.35% of range	0.35% of reading + 0.5% of range
45 Hz ≤ f < 440 Hz	0.15% of reading + 0.35% of range	0.15% of reading + 0.35% of range	0.25% of reading + 0.5% of range
440 Hz ≤ f < 1 kHz	0.2% of reading + 0.35% of range	0.2% of reading + 0.35% of range	0.4% of reading + 0.5% of range
1 kHz ≤ f < 2.5 kHz	0.8% of reading + 0.35% of range	0.9% of reading + 0.35% of range	1.7% of reading + 0.5% of range
2.5 kHz ≤ f < 5 kHz	3% of reading + 0.35% of range	3% of reading + 0.35% of range	6% of reading + 0.5% of range

However, all the items below apply to all tables.

- When the crest factor is set to 3
- When λ (power factor) = 1
- Power figures that exceed 440 Hz are reference values.
- For nth order component input, add (n/(m+1))/50% of (the nth order reading) to the n + mth order and n-mth order of the voltage and current.
- For the n+mth order and n-mth order of power, add (n/(m+1))/25% of the nth order reading.
- Add (n/500)% of reading to the nth component of the voltage and current, and add (n/250)% of reading to the nth component of the power.
- Accuracy when the crest factor is 6: The same as when the range is doubled for crest factor 3.
- The accuracy guaranteed range by frequency and voltage/current is the same as the guaranteed range of normal measurement. If the amplitude of the high frequency component is large, influence of approximately 1% may appear in certain orders. The influence depends on the size of the frequency component. Therefore, if the frequency component is small with respect to the range rating, this does not cause a problem.

Ethernet Communications (/C7 Optional)

Number of communication ports	1
Connector type	RJ-45 connector
Electrical and mechanical specifications	Conforms to IEEE 802.3. Ethernet 100BASE-TX
Transmission system	Max. 100 Mbps
Transmission rate	TCP/IP
Protocol	FTP server, DHCP, DNS, Remote control (VXI-11)
Supported Services	

USB port (PC)

Connector	Type B connector (receptacle)
Electrical and Mechanical Specifications	Conforms to USB Rev.1.1
Speed	Max. 12 Mbps
Number of Ports	1
Supported service	Remote control (USB-TMC)
Supported Systems	Models with standard USB ports that run Windows 2000, Windows XP, or Windows Vista with USB port as a standard.
Power Supply	Self Power

USB port (Peripheral)

Connector	Type A connector (receptacle)
Electrical and Mechanical Specifications	Conforms to USB Rev.2.0
Speed	Max. 480 Mbps
Number of Ports	2
Supported keyboards	104 keyboard (US) and 109 keyboard (Japanese) conforming to USB HID Class Ver.1.1 devices
Supported USB memory devices	USB (USB Mass Storage Class) flash memory
Power supply	5 V, 500 mA (per port) However, device whose maximum current consumption exceeds 100 mA cannot be connected simultaneously to the two ports.

Master/Slave Synchronization Signal Input/External Clock Input (Select)

Master/Slave Synchronization Signals	
Connector type	BNC connector: Both slave and master

External Clock Input

Connector type	BNC connector
Input level	TTL
Inputting the synchronization source as the Ext Clk of normal measurement.	
Frequency range	Same as the measurement range for frequency
Input waveform	50% duty ratio square wave
Inputting the PLL source as the Ext Clk of harmonic measurement. (/G5 option is required)	
Frequency range	10 Hz to 1.2 kHz
Input waveform	50% duty ratio square wave

For Triggers

Minimum pulse width	1 μs
Trigger delay time	Within (1 μs + 1 sample rate)

GP-IB Interface (/C1 optional)

Card driver

Use one of the following by NATIONAL INSTRUMENTS:	
• AT-GPIB	
• PCI-GPIB, PCI-GPIB+, and PCLe-GPIB	
• PCMCIA-GPIB and PCMCIA-GPIB+	
Use driver NI-488.2M version 1.60 or later.	
Conforms electrically and mechanically	IEEE Std 488-1978 (JIS C 1901-1987).
Functional specification	SH1, AH1, T6, L4, SR1, RL1, PP0, DC1, DT1, and C0.
Conforms to protocol	IEEE Std 488.2-1992.
Encoding	ISO (ASCII)
Mode	Addressable mode
Address	0–30
Clear remote mode	Remote mode can be cleared using the LOCAL key (except during Local Lockout).

General Specifications

Warm-up time	Approximately thirty minutes.
Operating temperature:	5–40°C
Operating humidity:	20–80% (when printer not used) (No condensation may be present)
Operating altitude	2000 m or less
Operating area	Inside of room
Storage environment:	-25–60°C (no condensation may be present)
Storage humidity:	20 to 80% RH (no condensation)
Rated supply voltage	100–240 VAC
Allowed supply voltage fluctuation range	90–264 VAC
Rated supply frequency	50/60 Hz
Allowed supply frequency fluctuation	48 to 63 Hz
Maximum power consumption	80 VA (when using built-in printer)
Weight	Approximately 6.5 kg (including main unit, 3 input elements, and options)

Model and Suffix Codes

Power Analyzer WT500

Model	Suffix Codes	Description
760201		WT500 1 input element model
760202		WT500 2 input elements model
760203		WT500 3 input elements model
Power cord	-D	UL/CSA standard
	-F	VDE standard
	-R	SAA standard
	-Q	BS standard
	-H	GB standard
Options	/C1	GP-IB interface
	/C7	Ethernet interface
	/EX1	External sensor input for 760201
	/EX2	External sensor input for 760202
	/EX3	External sensor input for 760203
	/G5	Harmonic Measurement
	/DT	Delta computation (760202/03 only)
	/FQ	Add-on Frequency Measurement (760202/03 only)
	/N1	VGA Output

Note: Adding input modules after initial product delivery will require rework at the factory. Please choose your models and configurations carefully, and inquire with your sales representative if you have any questions.

Standard accessories

Power cord, Rubber feet, current input protective cover, User's manual, Communication interface user's manual (CD-ROM), Safety terminal adapter 758931 (provided two adapters in a set times input element number)

Safety terminal adapter 758931



* Cable B9284LK (light blue) for external current sensor input is sold separately. Safety terminal adapter 758931 is included with the WT500. Other cables and adapters must be purchased by the user.

Exterior

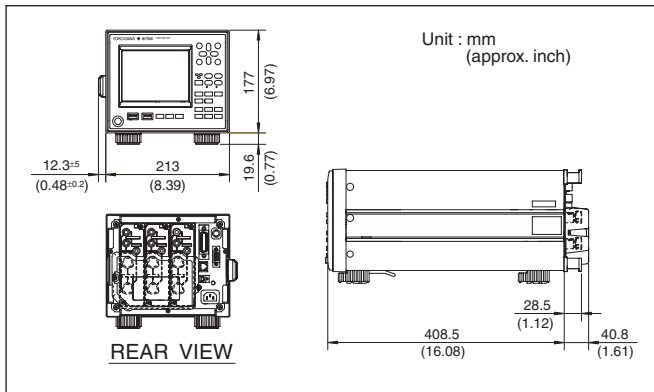

Rack Mount

Model	Product	Description
751533-E4	Rack mounting kit	For EIA Single mount
751533-J4	Rack mounting kit	For JIS Single mount
751534-E4	Rack mounting kit	For EIA Double mount
751534-J4	Rack mounting kit	For JIS Double mount

Accessory (sold separately)

Model/parts number	Product	Description	Order Q'ty
758917	Test read set	A set of 0.8m long, red and black test leads	1
758922	Small alligator-clip	Rated at 300V and used in a pair	1
758929	Large alligator-clip	Rated at 1000V and used in a pair	1
758923	Safety terminal adapter	(spring-hold type) Two adapters to a set.	1
758931	Safety terminal adapter	(screw-fastened type) Two adapters to a set. 1.5 mm hex Wrench is attached	1
758924	Conversion adapter	BNC-banana-jack(female) adapter	1
366924	BNC-BNC cable	1m	1
366925	BNC-BNC cable	2m	1
758921	Fork terminal adapter	Banana-fork adapter. Two adapters to a set	1
B9284LK	External sensor cable	Current sensor input connector. Length 0.5m	1

▲ Due to the nature of this product, it is possible to touch its metal parts. Therefore, there is a risk of electric shock, so the product must be used with caution.

* Use these products with low-voltage circuits (42V or less).

Application Software

Model	Product	Description	Order Q'ty
760122	WTViewer	Data acquisition software	1

Instrument Carts

Model	Suffix and codes	Description	Description
701960	/A	Compact cart	500*560*705 mm (W, D, H) Key board and mouse table
701961	/A	Deluxe cart	570*580*839 mm (W, D, H) Key board and mouse table
701962		General-purpose cart	467*693*713 mm (W, H, D)

Current Sensor Unit

Model	Suffix code	Description
751521		Single-phase
751523	-10	Three-phase U, V
	-20	Three-phase U, W
	-30	Three-phase U, V, W
Supply voltage	-1	100 V AC (50/60 Hz)
	-3	115 V AC (50/60 Hz)
	-7	230 V AC (50/60 Hz)
Power cord	-D	UL/CSA standard
	-F	VDE standard
	-R	SAA standard
	-J	BS standard
	-H	GB standard

* 751523-10 is designed for WT500, WT3000, PZ4000 and WT1800. 751523-20 is designed for the WT200 Series.

* 751521/751523 do not conform to CE Marking.

AC/DC Current sensor /Clamp on Probe

Model	Product Name	Description
CT1000	AC/DC Current sensor	DC~300 kHz, ±(0.05% of reading +30uA), 1000 Apk
CT200	AC/DC Current sensor	DC~500 kHz, ±(0.05% of reading +30uA), 200 Apk
CT60	AC/DC Current sensor	DC~800 kHz, ±(0.05% of reading +30uA), 60 Apk
751552	Clamp-on probe	30 Hz~5 kHz, 1400 Apeak(1000 Arms)
751574	AC/DC Current sensor	DC~100 kHz, 600 Apeak(400 Arms)

* CT series do not conform CE Marking.

* For detailed information, see Power Meter Accessory Catalog Bulletin 7515-52E

YOKOGAWA

Yokogawa Meters & Instruments Corporation

YOKOGAWA METERS & INSTRUMENTS CORPORATION
Global Sales Dept.

Tachihi Bld. No.2, 6-1-3 Sakaecho, Tachikawa-shi, Tokyo, 190-8586 Japan
Phone: +81-42-534-1413 Facsimile: +81-42-534-1426

Subject to change without notice.
All Rights Reserved, Copyright© 2008, Yokogawa Electric Corporation.

[Ed : 02/b]

Printed in Japan, 108(KP)

Aufgrund laufender Weiterentwicklungen sind Änderungen der Spezifikationen vorbehalten. Alle Angaben vorbehaltlich Satz- und Druckfehler.

nbn Austria GmbH

Riesstraße 146, 8010 Graz

+43 316 40 28 05

info@nbn.at | www.nbn.at